

PART 9

Rules for construction

CHAPTER 9.1

RULES FOR CONSTRUCTION OF DRY CARGO VESSELS

9.1.0 Rules for construction applicable to dry cargo vessels

Provisions of 9.1.0.0 to 9.1.0.79 apply to dry cargo vessels.

9.1.0.0 *Materials of construction*

The vessel's hull shall be constructed of shipbuilding steel or other metal, provided that this metal has at least equivalent mechanical properties and resistance to the effects of temperature and fire.

9.1.0.1-
9.1.0.10 (*Reserved*)

9.1.0.11 **Holds**

9.1.0.11.1 (a) Each hold shall be bounded fore and aft by watertight metal bulkheads.

(b) The holds shall have no common bulkhead with the oil fuel tanks.

9.1.0.11.2 The bottom of the holds shall be such as to permit them to be cleaned and dried.

9.1.0.11.3 The hatchway covers shall be spraytight and weathertight or be covered by waterproof tarpaulins.

Tarpaulins used to cover the holds shall not readily ignite.

9.1.0.11.4 No heating appliances shall be installed in the holds.

9.1.0.12 *Ventilation*

9.1.0.12.1 It must be possible to ventilate each hold by means of two mutually independent extraction ventilators having a capacity of not less than five changes of air per hour based on the volume of the empty hold. The ventilator fan shall be designed so that no sparks may be emitted on contact of the impeller blades with the housing and no static electricity may be generated. The extraction ducts shall be positioned at the extreme ends of the hold and extend down to not more than 50 mm above the bottom. The extraction of gases and vapours through the duct shall also be ensured for carriage in bulk.

If the extraction ducts are movable they shall be suitable for the ventilator assembly and capable of being firmly fixed. Protection shall be ensured against bad weather and spray. The air intake shall be ensured during ventilation.

9.1.0.12.2 The ventilation system of a hold shall be arranged so that dangerous gases cannot penetrate into the accommodation, wheelhouse or engine rooms.

9.1.0.12.3 Ventilation shall be provided for the accommodation and for service spaces.

9.1.0.13-
9.1.0.16 (*Reserved*)

9.1.0.17 *Accommodation and service spaces*

9.1.0.17.1 The accommodation shall be separated from the holds by metal bulkheads having no openings.

9.1.0.17.2 Gastight closing appliances shall be provided for openings in the accommodation and wheelhouse facing the holds.

9.1.0.17.3 No entrances or openings of the engine rooms and service spaces shall face the protected area.

9.1.0.18-
9.1.0.19 (*Reserved*)

9.1.0.20 *Water ballast*

The double-hull spaces and double bottoms may be arranged for being filled with water ballast.

9.1.0.21-
9.1.0.30 (*Reserved*)

9.1.0.31 *Engines*

9.1.0.31.1 Only internal combustion engines running on fuel having a flashpoint above 55 °C are allowed.

9.1.0.31.2 The air vents in the engine rooms and the air intakes of the engines which do not take air in directly from the engine room shall be located not less than 2.00 m from the protected area.

9.1.0.31.3 Sparking shall not be possible in the protected area.

9.1.0.32 *Oil fuel tanks*

9.1.0.32.1 Double bottoms within the hold area may be arranged as oil fuel tanks provided their depth is not less than 0.6 m. Oil fuel pipes and openings to such tanks are not permitted in the holds.

9.1.0.32.2 The air pipes of all oil fuel tanks shall be led to 0.50 m above the open deck. Their open ends and the open ends of the overflow pipes leading to the deck shall be fitted with a protective device consisting of a gauze grid or by a perforated plate.

9.1.0.33 (*Reserved*)

9.1.0.34 *Exhaust pipes*

9.1.0.34.1 Exhausts shall be evacuated from the vessel into the open air either upwards through an exhaust pipe or through the shell plating. The exhaust outlet shall be located not less than 2.00 m from the hatchway openings. The exhaust pipes of engines shall be arranged so that the exhausts are led away from the vessel. The exhaust pipes shall not be located within the protected area.

9.1.0.34.2 Exhaust pipes shall be provided with a device preventing the escape of sparks, e.g. spark arresters.

9.1.0.35 ***Stripping installation***

The stripping pumps intended for the holds shall be located in the protected area. This requirement shall not apply when stripping is effected by eductors.

9.1.0.36-
9.1.0.39 (*Reserved*)

9.1.0.40 ***Fire-extinguishing arrangements***

9.1.0.40.1 A fire-extinguishing system shall be installed on the vessel. This system shall comply with the following requirements:

- It shall be supplied by two independent fire or ballast pumps one of which shall be ready for use at any time. These pumps and their means of propulsion and electrical equipment shall not be installed in the same space;
- It shall be provided with a water main fitted with at least three hydrants in the protected area above deck. Three suitable and sufficiently long hoses with jet/spray nozzles having a diameter of not less than 12 mm shall be provided. Alternatively one or more of the hose assemblies may be substituted by directable jet/spray nozzles having a diameter of not less than 12 mm. It shall be possible to reach any point of the deck in the protected area simultaneously with at least two jets of water which do not emanate from the same hydrant. A spring-loaded non-return valve shall be fitted to ensure that no gases can escape through the fire-extinguishing system into the accommodation or service spaces outside the protected area;
- The capacity of the system shall be at least sufficient for a jet of water to reach a distance of not less than the vessel's breadth from any location on board with two spray nozzles being used at the same time.;
- The water supply system shall be capable of being put into operation from the wheelhouse and from the deck;
- Measures shall be taken to prevent the freezing of fire-mains and hydrants.

A single fire or ballast pump shall suffice on board pushed barges without their own means of propulsion.

9.1.0.40.2 In addition, the engine rooms shall be provided with a permanently fixed fire-extinguishing system meeting the following requirements:

9.1.0.40.2.1 *Extinguishing agents*

For the protection of spaces in engine rooms, boiler rooms and pump rooms, only permanently fixed fire-extinguishing systems using the following extinguishing agents are permitted:

- (a) CO₂ (carbon dioxide);
- (b) HFC 227 ea (heptafluoropropane);
- (c) IG-541 (52% nitrogen, 40% argon, 8% carbon dioxide);
- (d) FK-5-1-12 (dodecafluoro 2-methylpentane-3-one).

Other extinguishing agents are permitted only on the basis of recommendations by the Administrative Committee.

9.1.0.40.2.2 *Ventilation, air extraction*

- (a) The combustion air required by the combustion engines which ensure propulsion should not come from spaces protected by permanently fixed fire-extinguishing systems. This requirement is not mandatory if the vessel has two independent main engine rooms with a gastight separation or if, in addition to the main engine room, there is a separate engine room installed with a bow thruster that can independently ensure propulsion in the event of a fire in the main engine room.
- (b) All forced ventilation systems in the space to be protected shall be shut down automatically as soon as the fire-extinguishing system is activated.
- (c) All openings in the space to be protected which permit air to enter or gas to escape shall be fitted with devices enabling them to be closed rapidly. It shall be clear whether they are open or closed.
- (d) Air escaping from the pressure-relief valves of the pressurised air tanks installed in the engine rooms shall be evacuated to the open air.
- (e) Overpressure or negative pressure caused by the diffusion of the extinguishing agent shall not destroy the constituent elements of the space to be protected. It shall be possible to ensure the safe equalisation of pressure.
- (f) Protected spaces shall be provided with a means of extracting the extinguishing agent. If extraction devices are installed, it shall not be possible to start them up during extinguishing.

9.1.0.40.2.3 *Fire alarm system*

The space to be protected shall be monitored by an appropriate fire alarm system. The alarm signal shall be audible in the wheelhouse, the accommodation and the space to be protected.

9.1.0.40.2.4 *Piping system*

- (a) The extinguishing agent shall be routed to and distributed in the space to be protected by means of a permanent piping system. Piping installed in the space to be protected and the reinforcements it incorporates shall be made of steel. This shall not apply to the connecting nozzles of tanks and compensators provided that the materials used have equivalent fire-retardant properties. Piping shall be protected against corrosion both internally and externally.
- (b) The discharge nozzles shall be so arranged as to ensure the regular diffusion of the extinguishing agent. In particular, the extinguishing agent must also be effective beneath the floor.

9.1.0.40.2.5 *Triggering device*

- (a) Automatically activated fire-extinguishing systems are not permitted.
- (b) It shall be possible to activate the fire-extinguishing system from a suitable point located outside the space to be protected.

- (c) Triggering devices shall be so installed that they can be activated in the event of a fire and so that the risk of their breakdown in the event of a fire or an explosion in the space to be protected is reduced as far as possible.

Systems which are not mechanically activated shall be supplied from two energy sources independent of each other. These energy sources shall be located outside the space to be protected. The control lines located in the space to be protected shall be so designed as to remain capable of operating in the event of a fire for a minimum of 30 minutes. The electrical installations are deemed to meet this requirement if they conform to the IEC 60331-21:1999 standard.

When the triggering devices are so placed as not to be visible, the component concealing them shall carry the “Fire-fighting system” symbol, each side being not less than 10 cm in length, with the following text in red letters on a white ground:

Fire-extinguishing system

- (d) If the fire-extinguishing system is intended to protect several spaces, it shall comprise a separate and clearly-marked triggering device for each space;
- (e) The instructions shall be posted alongside all triggering devices and shall be clearly visible and indelible. The instructions shall be in a language the master can read and understand and if this language is not English, French or German, they shall be in English, French or German. They shall include information concerning:
 - (i) the activation of the fire-extinguishing system;
 - (ii) the need to ensure that all persons have left the space to be protected;
 - (iii) The correct behaviour of the crew in the event of activation and when accessing the space to be protected following activation or diffusion, in particular in respect of the possible presence of dangerous substances;
 - (iv) the correct behaviour of the crew in the event of the failure of the fire-extinguishing system to function properly.
- (f) The instructions shall mention that prior to the activation of the fire-extinguishing system, combustion engines installed in the space and aspirating air from the space to be protected, shall be shut down.

9.1.0.40.2.6 *Alarm device*

- (a) Permanently fixed fire-extinguishing systems shall be fitted with an audible and visual alarm device;
- (b) The alarm device shall be set off automatically as soon as the fire-extinguishing system is first activated. The alarm device shall function for an appropriate period of time before the extinguishing agent is released; it shall not be possible to turn it off;
- (c) Alarm signals shall be clearly visible in the spaces to be protected and their access points and be clearly audible under operating conditions corresponding to the highest possible sound level. It shall be possible to distinguish them clearly from all other sound and visual signals in the space to be protected;

- (d) Sound alarms shall also be clearly audible in adjoining spaces, with the communicating doors shut, and under operating conditions corresponding to the highest possible sound level;
- (e) If the alarm device is not intrinsically protected against short circuits, broken wires and drops in voltage, it shall be possible to monitor its operation;
- (f) A sign with the following text in red letters on a white ground shall be clearly posted at the entrance to any space the extinguishing agent may reach:

Warning, fire-extinguishing system!
Leave this space immediately when the ... (description) alarm is activated!

9.1.0.40.2.7 *Pressurised tanks, fittings and piping*

- (a) Pressurised tanks, fittings and piping shall conform to the requirements of the competent authority.
- (b) Pressurised tanks shall be installed in accordance with the manufacturer's instructions.
- (c) Pressurised tanks, fittings and piping shall not be installed in the accommodation.
- (d) The temperature of cabinets and storage spaces for pressurised tanks shall not exceed 50 °C.
- (e) Cabinets or storage spaces on deck shall be securely stowed and shall have vents so placed that in the event of a pressurised tank not being gastight, the escaping gas cannot penetrate into the vessel. Direct connections with other spaces are not permitted.

9.1.0.40.2.8 *Quantity of extinguishing agent*

If the quantity of extinguishing agent is intended for more than one space, the quantity of extinguishing agent available does not need to be greater than the quantity required for the largest of the spaces thus protected.

9.1.0.40.2.9 *Installation, maintenance, monitoring and documents*

- (a) The mounting or modification of the system shall only be performed by a company specialised in fire-extinguishing systems. The instructions (product data sheet, safety data sheet) provided by the manufacturer of the extinguishing agent or the system shall be followed.
- (b) The system shall be inspected by an expert:
 - (i) before being brought into service;
 - (ii) each time it is put back into service after activation;
 - (iii) after every modification or repair;
 - (iv) regularly, not less than every two years.
- (c) During the inspection, the expert is required to check that the system conforms to the requirements of 9.1.0.40.2.

- (d) The inspection shall include, as a minimum:
 - (i) an external inspection of the entire system;
 - (ii) an inspection to ensure that the piping is leakproof;
 - (iii) an inspection to ensure that the control and activation systems are in good working order;
 - (iv) an inspection of the pressure and contents of tanks;
 - (v) an inspection to ensure that the means of closing the space to be protected are leakproof;
 - (vi) an inspection of the fire alarm system;
 - (vii) an inspection of the alarm device.
- (e) The person performing the inspection shall establish, sign and date a certificate of inspection.
- (f) The number of permanently fixed fire-extinguishing systems shall be mentioned in the inspection certificate.

9.1.0.40.2.10 *Fire-extinguishing system operating with CO₂*

In addition to the requirements contained in 9.1.0.40.2.1 to 9.1.0.40.2.9, fire-extinguishing systems using CO₂ as an extinguishing agent shall conform to the following provisions:

- (a) Tanks of CO₂ shall be placed in a gastight space or cabinet separated from other spaces. The doors of such storage spaces and cabinets shall open outwards; they shall be capable of being locked and shall carry on the outside the symbol “Warning: general danger,” not less than 5 cm high and “CO₂” in the same colours and the same size;
- (b) Storage cabinets or spaces for CO₂ tanks located below deck shall only be accessible from the outside. These spaces shall have an artificial ventilation system with extractor hoods and shall be completely independent of the other ventilation systems on board;
- (c) The level of filling of CO₂ tanks shall not exceed 0.75 kg/l. The volume of depressurised CO₂ shall be taken to be 0.56 m³/kg;
- (d) The concentration of CO₂ in the space to be protected shall be not less than 40% of the gross volume of the space. This quantity shall be released within 120 seconds. It shall be possible to monitor whether diffusion is proceeding correctly;
- (e) The opening of the tank valves and the control of the diffusing valve shall correspond to two different operations;
- (f) The appropriate period of time mentioned in 9.1.0.40.2.6 (b) shall be not less than 20 seconds. A reliable installation shall ensure the timing of the diffusion of CO₂.

9.1.0.40.2.11 *Fire-extinguishing system operating with HFC-227 ea (heptafluoropropane)*

In addition to the requirements of 9.1.0.40.2.1 to 9.1.0.40.2.9, fire-extinguishing systems using HFC-227 ea as an extinguishing agent shall conform to the following provisions:

- (a) Where there are several spaces with different gross volumes, each space shall be equipped with its own fire-extinguishing system;
- (b) Every tank containing HFC-227 ea placed in the space to be protected shall be fitted with a device to prevent overpressure. This device shall ensure that the contents of the tank are safely diffused in the space to be protected if the tank is subjected to fire, when the fire-extinguishing system has not been brought into service;
- (c) Every tank shall be fitted with a device permitting control of the gas pressure;
- (d) The level of filling of tanks shall not exceed 1.15 kg/l. The specific volume of depressurised HFC-227 ea shall be taken to be 0.1374 m³/kg;
- (e) The concentration of HFC-227 ea in the space to be protected shall be not less than 8% of the gross volume of the space. This quantity shall be released within 10 seconds;
- (f) Tanks of HFC-227 ea shall be fitted with a pressure monitoring device which triggers an audible and visual alarm in the wheelhouse in the event of an unscheduled loss of propellant gas. Where there is no wheelhouse, the alarm shall be triggered outside the space to be protected;
- (g) After discharge, the concentration in the space to be protected shall not exceed 10.5% (volume);
- (h) The fire-extinguishing system shall not comprise aluminium parts.

9.1.0.40.2.12 *Fire-extinguishing system operating with IG-541*

In addition to the requirements of 9.1.0.40.2.1 to 9.1.0.40.2.9, fire-extinguishing systems using IG-541 as an extinguishing agent shall conform to the following provisions:

- (a) Where there are several spaces with different gross volumes, every space shall be equipped with its own fire-extinguishing system;
- (b) Every tank containing IG-541 placed in the space to be protected shall be fitted with a device to prevent overpressure. This device shall ensure that the contents of the tank are safely diffused in the space to be protected if the tank is subjected to fire, when the fire-extinguishing system has not been brought into service;
- (c) Each tank shall be fitted with a device for checking the contents;
- (d) The filling pressure of the tanks shall not exceed 200 bar at a temperature of +15 °C;
- (e) The concentration of IG-541 in the space to be protected shall be not less than 44% and not more than 50% of the gross volume of the space. This quantity shall be released within 120 seconds.

9.1.0.40.2.13 *Fire-extinguishing system operating with FK-5-1-12*

In addition to the requirements of 9.1.0.40.2.1 to 9.1.0.40.2.9, fire-extinguishing systems using FK-5-1-12 as an extinguishing agent shall comply with the following provisions:

- (a) Where there are several spaces with different gross volumes, every space shall be equipped with its own fire-extinguishing system;
- (b) Every tank containing FK-5-1-12 placed in the space to be protected shall be fitted with a device to prevent overpressure. This device shall ensure that the contents of the tank are safely diffused in the space to be protected if the tank is subjected to fire, when the fire-extinguishing system has not been brought into service;
- (c) Every tank shall be fitted with a device permitting control of the gas pressure;
- (d) The level of filling of tanks shall not exceed 1.00 kg/l. The specific volume of depressurized FK-5-1-12 shall be taken to be 0.0719 m³/kg;
- (e) The volume of FK-5-1-12 in the space to be protected shall be not less than 5.5% of the gross volume of the space. This quantity shall be released within 10 seconds;
- (f) Tanks of FK-5-1-12 shall be fitted with a pressure monitoring device which triggers an audible and visual alarm in the wheelhouse in the event of an unscheduled loss of extinguishing agent. Where there is no wheelhouse, the alarm shall be triggered outside the space to be protected;
- (g) After discharge, the concentration in the space to be protected shall not exceed 10.0%.

9.1.0.40.2.14 *Fixed fire-extinguishing system for physical protection*

In order to ensure physical protection in the engine rooms, boiler rooms and pump rooms, permanently fixed fire-extinguishing systems are accepted solely on the basis of recommendations by the Administrative Committee.

9.1.0.40.3 The two hand fire-extinguishers referred to in 8.1.4 shall be located in the protected area or in proximity to it.

9.1.0.40.4 The fire-extinguishing agent in the permanently fixed fire-extinguishing system shall be suitable and sufficient for fighting fires.

9.1.0.41 *Fire and naked light*

9.1.0.41.1 The outlets of funnels shall be located not less than 2 m from the hatchway openings. Arrangements shall be provided to prevent the escape of sparks and the entry of water.

9.1.0.41.2 Heating, cooking and refrigerating appliances shall not be fuelled with liquid fuels, liquid gas or solid fuels. The installation in the engine room or other separate space of heating appliances fuelled with liquid fuel having a flashpoint above 55 °C is, however, permitted.

Cooking and refrigerating appliances are permitted only in wheelhouses with metal floor and in the accommodation.

9.1.0.41.3 Electric lighting appliances are only permitted outside the accommodation and the wheelhouse.

9.1.0.42-
9.1.0.51 (Reserved)

9.1.0.52 *Type and location of electrical equipment*

9.1.0.52.1 It shall be possible to isolate the electrical equipment in the protected area by means of centrally located switches except where:

- in the holds it is of a certified safe type corresponding at least to temperature class T4 and explosion group II B; and
- in the protected area on the deck it is of the limited explosion risk type.

The corresponding electrical circuits shall have control lamps to indicate whether or not the circuits are live.

The switches shall be protected against unintended unauthorized operation. The sockets used in this area shall be so designed as to prevent connections being made except when they are not live. Submerged pumps installed or used in the holds shall be of the certified safe type at least for temperature class T4 and explosion group II B.

9.1.0.52.2 Electric motors for hold ventilators which are arranged in the air flow shall be of the certified safe type.

9.1.0.52.3 Sockets for the connection of signal lights and gangway lighting shall be solidly fitted to the vessel close to the signal mast or the gangway. Sockets intended to supply the submerged pumps, hold ventilators and containers shall be permanently fitted to the vessel in the vicinity of the hatches.

9.1.0.52.4 Accumulators shall be located outside the protected area.

9.1.0.53-
9.1.0.55 (Reserved)

9.1.0.56 *Electric cables*

9.1.0.56.1 Cables and sockets in the protected area shall be protected against mechanical damage.

9.1.0.56.2 Movable cables are prohibited in the protected area, except for intrinsically safe electric circuits or for the supply of signal lights and gangway lighting, for containers, for submerged pumps, hold ventilators and for electrically operated cover gantries.

9.1.0.56.3 For movable cables permitted in accordance with 9.1.0.56.2 above, only rubber-sheathed cables of type H07 RN-F in accordance with standard IEC-60 245-4:1994 or cables of at least equivalent design having conductors with a cross-section of not less than 1.5 mm², shall be used. These cables shall be as short as possible and installed so that damage is not likely to occur.

9.1.0.57-
9.1.0.69 (Reserved)

9.1.0.70 *Metal wires, masts*

All metal wires passing over the holds and all masts shall be earthed, unless they are electrically bonded to the metal hull of the vessel through their installation.

9.1.0.71 ***Admittance on board***

The notice boards displaying the prohibition of admittance in accordance with 8.3.3 shall be clearly legible from either side of the vessel.

9.1.0.72-
9.1.0.73 (*Reserved*)

9.1.0.74 ***Prohibition of smoking, fire and naked light***

9.1.0.74.1 The notice boards displaying the prohibition of smoking in accordance with 8.3.4 shall be clearly legible from either side of the vessel.

9.1.0.74.2 Notice boards indicating the circumstances under which the prohibition applies shall be fitted near the entrances to the spaces where smoking or the use of fire or naked light is not always prohibited.

9.1.0.74.3 Ashtrays shall be provided close to each exit of the accommodation and the wheelhouse.

9.1.0.75-
9.1.0.79 (*Reserved*)

9.1.0.80 ***Additional rules applicable to double-hull vessels***

The rules of 9.1.0.88 to 9.1.0.99 are applicable to double-hull vessels intended to carry dangerous goods of Classes 2, 3, 4.1, 4.2, 4.3, 5.1, 5.2, 6.1, 7, 8 or 9, except those for which label No. 1 is prescribed in column (5) of Table A of Chapter 3.2, in quantities exceeding those of 7.1.4.1.1.

9.1.0.81-
9.1.0.87 (*Reserved*)

9.1.0.88 ***Classification***

9.1.0.88.1 Double-hull vessels intended to carry dangerous goods of Classes 2, 3, 4.1, 4.2, 4.3, 5.1, 5.2, 6.1, 7, 8 or 9 except those for which label No. 1 is prescribed in column (5) of Table A of Chapter 3.2, in quantities exceeding those referred to in 7.1.4.1.1 shall be built or transformed under survey of a recognised classification society in accordance with the rules established by that classification society to its highest class. This shall be confirmed by the classification society by the issue of an appropriate certificate.

9.1.0.88.2 Continuation of class is not required.

9.1.0.88.3 Future conversions and major repairs to the hull shall be carried out under survey of this classification society.

9.1.0.89-
9.1.0.90 (*Reserved*)

9.1.0.91 ***Holds***

9.1.0.91.1 The vessel shall be built as a double-hull vessel with double-hull spaces and double bottom within the protected area.

9.1.0.91.2 The distance between the sides of the vessel and the longitudinal bulkheads of the hold shall be not less than 0.80 m. Regardless of the requirements relating to the width of walkways on

deck, a reduction of this distance to 0.60 m is permitted, provided that, compared with the scantlings specified in the rules for construction published by a recognised classification society, the following reinforcements have been made:

- (a) Where the vessel's sides are constructed according to the longitudinal framing system, the frame spacing shall not exceed 0.60 m.

The longitudinals shall be supported by web frames with lightening holes similar to the floors in the double bottom and spaced not more than 1.80 m apart. These intervals may be increased if the construction is correspondingly reinforced;

- (b) Where the vessel's sides are constructed according to the transverse framing system, either:

- two longitudinal side shell stringers shall be fitted. The distance between the two stringers and between the uppermost stringer and the gangboard shall not exceed 0.80 m. The depth of the stringers shall be at least equal to that of the transverse frames and the cross-section of the face plate shall be not less than 15 cm².

The longitudinal stringers shall be supported by web frames with lightening holes similar to plate floors in the double bottom and spaced not more than 3.60 m apart. The transverse shell frames and the hold bulkhead vertical stiffeners shall be connected at the bilge by a bracket plate with a height of not less than 0.90 m and thickness equal to the thickness of the floors; or

- web frames with lightening holes similar to the double bottom plate floors shall be arranged on each transverse frame;

- (c) The gangboards shall be supported by transverse bulkheads or cross-ties spaced not more than 32 m apart.

As an alternative to compliance with the requirements of (c) above, a proof by calculation, issued by a recognised classification society confirming that additional reinforcements have been fitted in the double-hull spaces and that the vessel's transverse strength may be regarded as satisfactory.

- 9.1.0.91.3 The depth of the double bottom shall be at least 0.50 m. The depth below the suction wells may, however, be locally reduced, but the space between the bottom of the suction well and the bottom of the vessel floor shall be at least 0.40 m. If spaces are between 0.40 m and 0.49 m, the surface area of the suction well shall not exceed 0.5 m².

The capacity of the suction wells must not exceed 0.120 m³.

9.1.0.92 *Emergency exit*

Spaces the entrances or exits of which are partly or fully immersed in damaged condition shall be provided with an emergency exit not less than 0.10 m above the waterline. This does not apply to forepeak and afterpeak.

9.1.0.93 *Stability (general)*

- 9.1.0.93.1 Proof of sufficient stability shall be furnished including stability in the damaged condition.

- 9.1.0.93.2 The basic values for the stability calculation - the vessel's lightweight and the location of the centre of gravity - shall be determined either by means of an inclining experiment or by

detailed mass and moment calculation. In the latter case the lightweight shall be checked by means of a lightweight test with a resulting difference of not more than $\pm 5\%$ between the mass determined by the calculation and the displacement determined by the draught readings.

- 9.1.0.93.3 Proof of sufficient intact stability shall be furnished for all stages of loading and unloading and for the final loading condition.

Floatability after damage shall be proved for the most unfavourable loading condition. For this purpose calculated proof of sufficient stability shall be established for critical intermediate stages of flooding and for the final stage of flooding. Negative values of stability in intermediate stages of flooding may be accepted only if the continued range of curve of righting lever in damaged condition indicates adequate positive values of stability.

9.1.0.94 *Stability (intact)*

- 9.1.0.94.1 The requirements for intact stability resulting from the damaged stability calculation shall be fully complied with.

- 9.1.0.94.2 For the carriage of containers, proof of sufficient stability shall also be furnished in accordance with the provisions of the Regulations referred to in 1.1.4.6.

- 9.1.0.94.3 The most stringent of the requirements of 9.1.0.94.1 and 9.1.0.94.2 above shall prevail for the vessel.

9.1.0.95 *Stability (damaged condition)*

- 9.1.0.95.1 The following assumptions shall be taken into consideration for the damaged condition:

- (a) The extent of side damage is as follows:

longitudinal extent:	at least 0.10 L, but not less than 5.00 m;
transverse extent:	0.59 m;
vertical extent:	from the baseline upwards without limit;

- (b) The extent of bottom damage is as follows:

longitudinal extent:	at least 0.10 L, but not less than 5.00 m;
transverse extent:	3.00 m;
vertical extent:	from the base 0.49 m upwards, the sump excepted;

- (c) Any bulkheads within the damaged area shall be assumed damaged, which means that the location of bulkheads shall be chosen so as to ensure that the vessel remains afloat after the flooding of two or more adjacent compartments in the longitudinal direction.

The following provisions are applicable:

- For bottom damage also two adjacent athwartships compartments shall be assumed as flooded;
- The lower edge of any openings that cannot be closed watertight (e.g. doors, windows, access hatchways) shall, at the final stage of flooding, be not less than 0.10 m above the damage waterline;

- In general, permeability shall be assumed to be 95%. Where an average permeability of less than 95% is calculated for any compartment, this calculated value may be used.

However, the following minimum values shall be used:

- engine rooms: 85%
- accommodation: 95%
- double bottoms, oil fuel tanks, ballast tanks, etc., depending on whether, according to their function, they have to be assumed as full or empty for the vessel floating at the maximum permissible draught: 0% or 95%

For the main engine room only the one-compartment standard needs to be taken into account, i.e. the end bulkheads of the engine room shall be assumed as not damaged.

9.1.0.95.2

At the stage of equilibrium (final stage of flooding) the angle of heel shall not exceed 12° . Non-watertight openings shall not be immersed before reaching the stage of equilibrium. If such openings are immersed before that stage, the corresponding spaces shall be considered as flooded for the purpose of stability calculation.

The positive range of the righting lever curve beyond the position of equilibrium shall have a righting lever of ≥ 0.05 m in association with an area under the curve of ≥ 0.0065 m.rad. The minimum values of stability shall be satisfied up to immersion of the first non-weather-tight opening and in any event up to an angle of heel $\leq 27^\circ$. If non-weather-tight openings are immersed before that stage, the corresponding spaces shall be considered as flooded for the purposes of stability calculation.

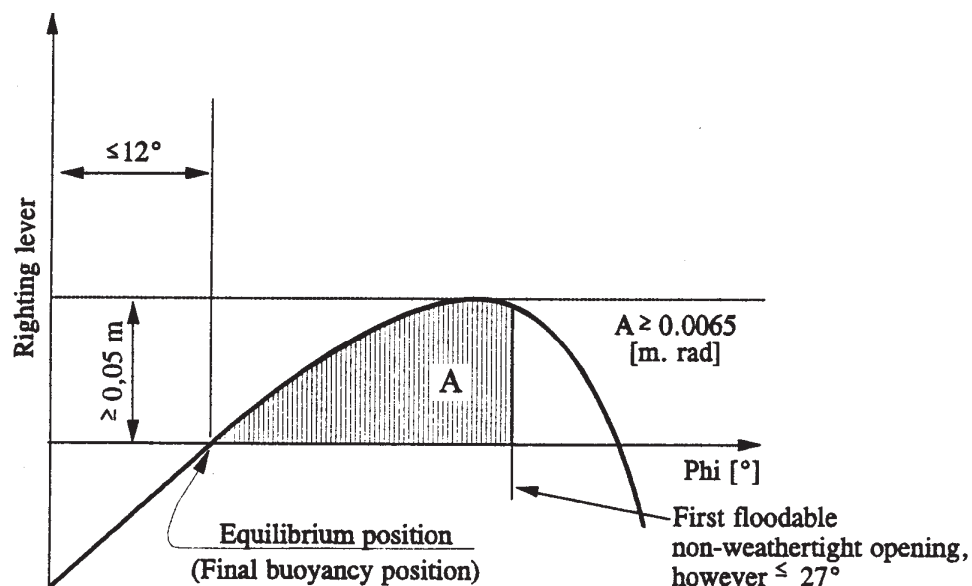

9.1.0.95.3

Inland navigation vessels carrying containers which have not been secured shall satisfy the following damage stability criteria:

At the stage of equilibrium (final stage of flooding) the angle of heel shall not exceed 5° . Non-watertight openings shall not be immersed before reaching the stage of equilibrium. If such openings are immersed before that stage, the corresponding spaces shall be considered as flooded for the purpose of stability calculation;

The positive range of the righting lever curve beyond the position of equilibrium shall have an area under the curve of ≥ 0.0065 m.rad. The minimum values of stability shall be satisfied up to immersion of the first non-weather-tight opening and in any event up to an angle of heel $\leq 10^\circ$. If non-weather-tight openings are immersed before that stage, the corresponding spaces shall be considered as flooded for the purposes of stability calculation.

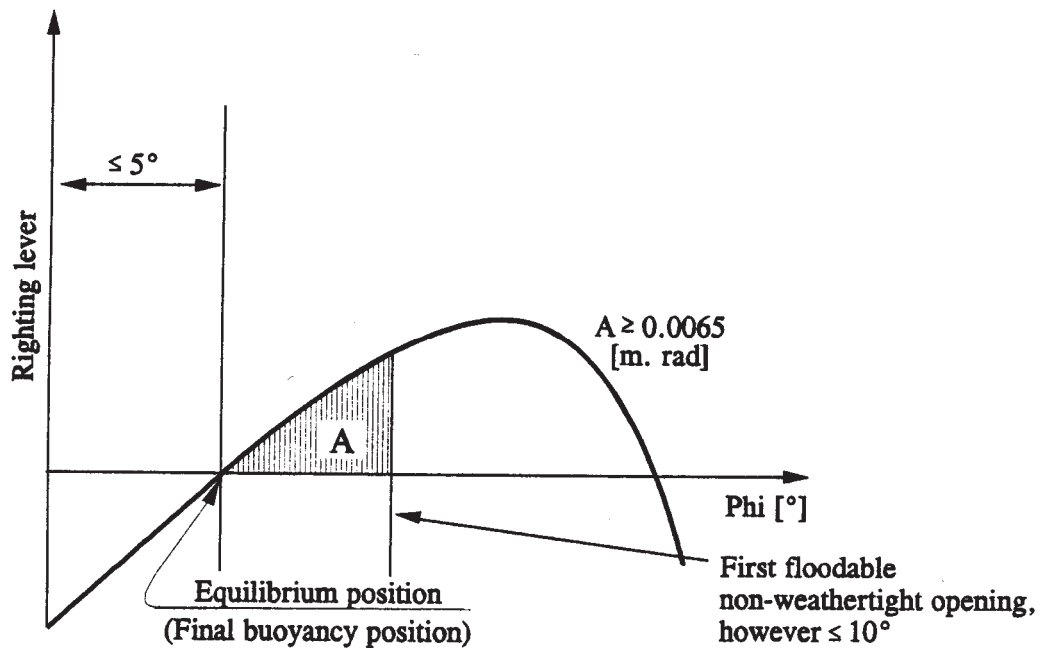

- 9.1.0.95.4 If openings through which undamaged compartments may become additionally flooded are capable of being closed watertight, the closing devices shall be appropriately marked.
- 9.1.0.95.5 Where cross- or down-flooding openings are provided for reduction of unsymmetrical flooding, the time for equalisation shall not exceed 15 minutes if during the intermediate stages of flooding sufficient stability has been proved.
- 9.1.0.96-
9.1.0.99 (Reserved)

CHAPTER 9.2

RULES FOR CONSTRUCTION APPLICABLE TO SEAGOING VESSELS WHICH COMPLY WITH THE REQUIREMENTS OF THE SOLAS 74 CONVENTION, CHAPTER II-2, REGULATION 19 OR SOLAS 74, CHAPTER II-2, REGULATION 54

9.2.0 The requirements of 9.2.0.0 to 9.2.0.79 are applicable to seagoing vessels which comply with the following requirements:

- SOLAS 74, Chapter II-2, Regulation 19 in its amended version; or
- SOLAS 74, Chapter II-2, Regulation 54 in its amended version in accordance with the resolutions mentioned in Chapter II-2, Regulation 1, paragraph 2.1, provided that the vessel was constructed before 1 July 2002.

Seagoing vessels which do not comply with the above-mentioned requirements of the SOLAS 74 Convention shall meet the requirements of 9.1.0.0 to 9.1.0.79.

9.2.0.0 *Materials of construction*

The vessel's hull shall be constructed of shipbuilding steel or other metal, provided that this metal has at least equivalent mechanical properties and resistance to the effects of temperature and fire.

9.2.0.1-
9.2.0.19 (*Reserved*)

9.2.0.20 *Water ballast*

The double-hull spaces and double bottoms may be arranged for being filled with water ballast.

9.2.0.21-
9.2.0.30 (*Reserved*)

9.2.0.31 *Engines*

9.2.0.31.1 Only internal combustion engines running on a fuel having a flashpoint above 60 °C, are allowed.

9.2.0.31.2 Ventilation inlets of the engine rooms and the air intakes of the engines which do not take air in directly from the engine room shall be located not less than 2 m from the protected area.

9.2.0.31.3 Sparking shall not be possible in the protected area.

9.2.0.32-
9.2.0.33 (*Reserved*)

9.2.0.34 *Exhaust pipes*

9.2.0.34.1 Exhausts shall be evacuated from the vessel into the open-air either upwards through an exhaust pipe or through the shell plating. The exhaust outlet shall be located not less than 2.00 m from the hatchway openings. The exhaust pipes of engines shall be arranged so that the exhausts are led away from the vessel. The exhaust pipes shall not be located within the protected area.

- 9.2.0.34.2 Exhaust pipes shall be provided with a device preventing the escape of sparks, e.g. spark arresters.
- 9.2.0.35-
9.2.0.40 *(Reserved)*
- 9.2.0.41 *Fire and naked light***
- 9.2.0.41.1 The outlets of funnels shall be located not less than 2.00 m from the hatchway openings. Arrangements shall be provided to prevent the escape of sparks and the entry of water.
- 9.2.0.41.2 Heating, cooking and refrigerating appliances shall not be fuelled with liquid fuels, liquid gas or solid fuels. The installation in the engine room or other separate space of heating appliances fuelled with liquid fuel having a flashpoint above 55 °C shall, however, be permitted.
- Cooking and refrigerating appliances are permitted only in wheelhouses with metal floor and in the accommodation.
- 9.2.0.41.3 Electric lighting appliances are only permitted outside the accommodation and the wheelhouse.
- 9.2.0.42-
9.2.0.70 *(Reserved)*
- 9.2.0.71 *Admittance on board***
- The notice boards displaying the prohibition of admittance in accordance with 8.3.3 shall be clearly legible from either side of the vessel.
- 9.2.0.72-
9.2.0.73 *(Reserved)*
- 9.2.0.74 *Prohibition of smoking, fire and naked light***
- 9.2.0.74.1 The notice boards displaying the prohibition of smoking in accordance with 8.3.4 shall be clearly legible from either side of the vessel.
- 9.2.0.74.2 Notice boards indicating the circumstances under which the prohibition applies shall be fitted near the entrances to the spaces where smoking or the use of fire or naked light is not always prohibited.
- 9.2.0.74.3 Ashtrays shall be provided close to each exit of the wheelhouse.
- 9.2.0.75-
9.2.0.79 *(Reserved)*
- 9.2.0.80 *Additional rules applicable to double-hull vessels***
- The rules of 9.2.0.88 to 9.2.0.99 are applicable to double-hull vessels intended to carry dangerous goods of Classes 2, 3, 4.1, 4.2, 4.3, 5.1, 5.2, 6.1, 7, 8 or 9, except those for which label No. 1 is prescribed in column (5) of Table A of Chapter 3.2, in quantities exceeding those of 7.1.4.1.1.
- 9.2.0.81-
9.2.0.87 *(Reserved)*

9.2.0.88 ***Classification***

9.2.0.88.1 Double-hull vessels intended to carry dangerous goods of Classes 2, 3, 4.1, 4.2, 4.3, 5.1, 5.2, 6.1, 7, 8 or 9 except those for which label No. 1 is prescribed in column (5) of Table A of Chapter 3.2, in quantities exceeding those referred to in 7.1.4.1, shall be built under survey of a recognised classification society in accordance with the rules established by that classification society to its highest class. This shall be confirmed by the classification society by the issue of an appropriate certificate.

9.2.0.88.2 The vessel's highest class shall be continued.

9.2.0.89-
9.2.0.90 (*Reserved*)

9.2.0.91 ***Holds***

9.2.0.91.1 The vessel shall be built as a double-hull vessel with double-wall spaces and double bottom within the protected area.

9.2.0.91.2 The distance between the sides of the vessel and the longitudinal bulkheads of the hold shall be not less than 0.80 m. A locally reduced distance at the vessel's ends shall be permitted, provided the smallest distance between vessel's side and the longitudinal bulkhead (measured perpendicular to the side) is not less than 0.60 m. The sufficient structural strength of the vessel (longitudinal, transverse and local strength) shall be confirmed by the class certificate.

9.2.0.91.3 The depth of the double bottom shall be not less than 0.50 m.

The depth below the suction wells may however be locally reduced to 0.40 m, provided the suction well has a capacity of not more than 0.03 m³.

9.2.0.92 (*Reserved*)

9.2.0.93 ***Stability (general)***

9.2.0.93.1 Proof of sufficient stability shall be furnished including stability in the damaged condition.

9.2.0.93.2 The basic values for the stability calculation - the vessel's lightweight and the location of the centre of gravity - shall be determined either by means of an inclining experiment or by detailed mass and moment calculation. In the latter case the lightweight shall be checked by means of a lightweight test with a resulting difference of not more than ± 5% between the mass determined by the calculation and the displacement determined by the draught readings.

9.2.0.93.3 Proof of sufficient intact stability shall be furnished for all stages of loading and unloading and for the final loading condition.

Floatability after damage shall be proved for the most unfavourable loading condition. For this purpose calculated proof of sufficient stability shall be established for critical intermediate stages of flooding and for the final stage of flooding. Negative values of stability in intermediate stages of flooding may be accepted only if the continued range of curve of righting lever in damaged condition indicates adequate positive values of stability.

9.2.0.94 ***Stability (intact)***

9.2.0.94.1 The requirements for intact stability resulting from the damaged stability calculation shall be fully complied with.

9.2.0.94.2 For the carriage of containers, additional proof of sufficient stability shall be furnished in accordance with the requirements of the Regulations referred to in 1.1.4.6.

9.2.0.94.3 The most stringent of the requirements of 9.2.0.94.1 and 9.2.0.94.2 shall prevail for the vessel.

9.2.0.94.4 For seagoing vessels the provisions of 9.2.0.94.2 above may be regarded as having been complied with if the stability conforms to Resolution A.749 (18) of the International Maritime Organization and the stability documents have been checked by the competent authority. This applies only when all containers are secured as usual on seagoing vessels and a relevant stability document has been approved by the competent authority.

9.2.0.95 ***Stability (damaged condition)***

9.2.0.95.1 The following assumptions shall be taken into consideration for the damaged condition:

(a) The extent of side damage is as follows:

longitudinal extent: at least 0.10 L, but not less than 5.00 m;
transverse extent: 0.59 m;
vertical extent: from the baseline upwards without limit;

(b) The extent of bottom damage is as follows:

longitudinal extent: at least 0.10 L, but not less than 5.00 m;
transverse extent: 3.00 m;
vertical extent: from the base 0.49 m upwards, the sump excepted;

(c) Any bulkheads within the damaged area shall be assumed damaged, which means that the location of bulkheads shall be chosen so that the vessel will remain afloat after flooding of two or more adjacent compartments in the longitudinal direction.

The following provisions are applicable:

- For bottom damage, adjacent athwartship compartments shall also be assumed as flooded;
- The lower edge of any openings that cannot be closed watertight (e.g. doors, windows, access hatchways) shall, at the final stage of flooding, be not less than 0.10 m above the damage waterline;
- In general, permeability shall be assumed to be 95%. Where an average permeability of less than 95% is calculated for any compartment, this calculated value may be used.

However, the following minimum values shall be used:

- engine rooms 85%
- accommodation 95%

- double bottoms, oil fuel tanks, ballast tanks, etc., depending on whether according to their function, they have to be assumed as full or empty for the vessel floating at the maximum permissible draught 0% or 95%

For the main engine room only the one-compartment standard needs to be taken into account. (Consequently, the end bulkheads of the engine room shall be assumed as not damaged.)

9.2.0.95.2 At the stage of equilibrium (final stage of flooding) the angle of heel shall not exceed 12° . Non-watertight openings shall not be immersed before reaching the stage of equilibrium. If such openings are immersed before that stage, the corresponding spaces shall be considered as flooded for the purpose of stability calculation.

The positive range of the righting lever curve beyond the position of equilibrium shall have a righting lever of ≥ 0.05 m in association with an area under the curve of ≥ 0.0065 m.rad. The minimum values of stability shall be satisfied up to immersion of the first non-weathertight opening and in any event up to an angle of heel $\leq 27^\circ$. If non-weathertight openings are immersed before that stage, the corresponding spaces shall be considered as flooded for the purposes of stability calculation.

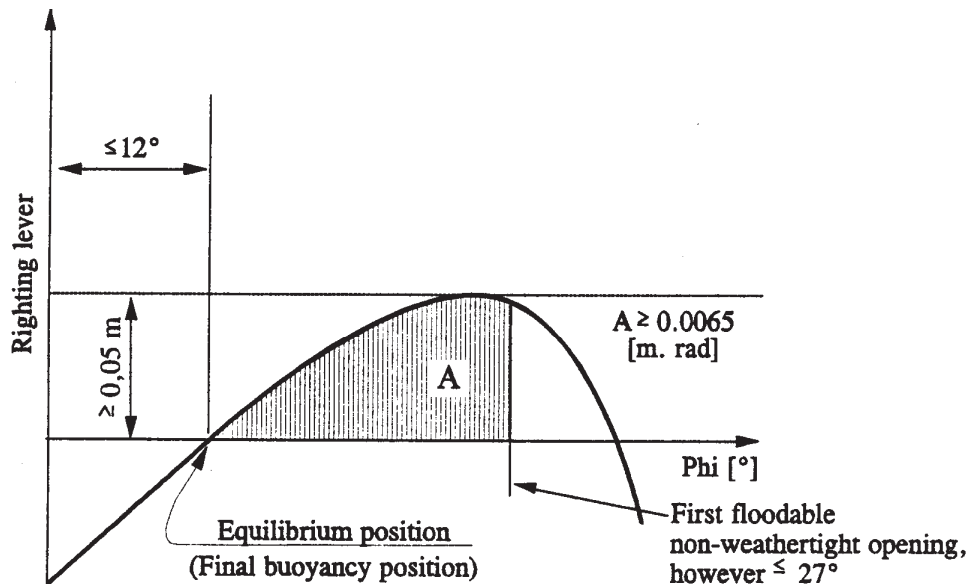

9.2.0.95.3 If openings through which undamaged compartments may become additionally flooded are capable of being closed watertight, the closing devices shall be appropriately marked.

9.2.0.95.4 Where cross- or down-flooding openings are provided for reduction of unsymmetrical flooding, the time for equalisation shall not exceed 15 minutes if during the intermediate stages of flooding sufficient stability has been proved.

9.2.0.96-
9.2.0.99 (Reserved)

CHAPTER 9.3

RULES FOR CONSTRUCTION OF TANK VESSELS

9.3.1 Rules for construction of type G tank vessels

The rules for construction of 9.3.1.0 to 9.3.1.99 apply to type G tank vessels.

9.3.1.0 *Materials of construction*

- 9.3.1.0.1 (a) The vessel's hull and the cargo tanks shall be constructed of shipbuilding steel or other at least equivalent metal.

The independent cargo tanks may also be constructed of other materials, provided these have at least equivalent mechanical properties and resistance against the effects of temperature and fire.

- (b) Every part of the vessel including any installation and equipment which may come into contact with the cargo shall consist of materials which can neither be dangerously affected by the cargo nor cause decomposition of the cargo or react with it so as to form harmful or hazardous products. In case it has not been possible to examine this during classification and inspection of the vessel a relevant reservation shall be entered in the vessel substance list according to 1.16.1.2.5.

- 9.3.1.0.2 Except where explicitly permitted in 9.3.1.0.3 below or in the certificate of approval, the use of wood, aluminium alloys or plastic materials within the cargo area is prohibited.

- 9.3.1.0.3 (a) The use of wood, aluminium alloys or plastic materials within the cargo area is only permitted for:

- gangways and external ladders;
- movable items of equipment;
- chocking of cargo tanks which are independent of the vessel's hull and chocking of installations and equipment;
- masts and similar round timber;
- engine parts;
- parts of the electrical installation;
- lids of boxes which are placed on the deck.

- (b) The use of wood or plastic materials within the cargo area is only permitted for:

- supports and stops of any kind.

- (c) The use of plastic materials or rubber within the cargo area is only permitted for:

- all kinds of gaskets (e.g. for dome or hatch covers);
- electric cables;
- hose assemblies for loading and unloading;

- insulation of cargo tanks and of piping for loading and unloading;
- photo-optical copies of the certificate of approval according to 8.1.2.6 or 8.1.2.7.

(d) All permanently fitted materials in the accommodation or wheelhouse, with the exception of furniture, shall not readily ignite. They shall not evolve fumes or toxic gases in dangerous quantities, if involved in a fire.

9.3.1.0.4 The paint used in the cargo area shall not be liable to produce sparks in case of impact.

9.3.1.0.5 The use of plastic material for vessel's boats is permitted only if the material does not readily ignite.

9.3.1.1-
9.3.1.7 (*Reserved*)

9.3.1.8 Classification

9.3.1.8.1 The tank vessel shall be built under survey of a recognised classification society in accordance with the rules established by that classification society for its highest class, and the tank vessel shall be classed accordingly.

The vessel's highest class shall be continued.

The classification society shall issue a certificate certifying that the vessel is in conformity with the rules of this section (classification certificate).

The design pressure and the test pressure of cargo tanks shall be entered in the certificate.

If a vessel has cargo tanks with different valve opening pressures, the design and test pressures of each tank shall be entered in the certificate.

The classification society shall draw up a vessel substance list mentioning all the dangerous goods accepted for carriage by the tank vessel (see also 1.16.1.2.5).

9.3.1.8.2 The cargo pump-rooms shall be inspected by a recognised classification society whenever the certificate of approval has to be renewed as well as during the third year of validity of the certificate of approval. The inspection shall comprise at least:

- an inspection of the whole system for its condition, for corrosion, leakage or conversion works which have not been approved;
- a checking of the condition of the gas detection system in the cargo pump-rooms.

Inspection certificates signed by the recognised classification society with respect to the inspection of the cargo pump-rooms shall be kept on board. The inspection certificates shall at least include particulars of the above inspection and the results obtained as well as the date of the inspection.

9.3.1.8.3 The condition of the gas detection system referred to in 9.3.1.52.3 shall be checked by a recognised classification society whenever the certificate of approval has to be renewed and during the third year of validity of the certificate of approval. A certificate signed by the recognised classification society shall be kept on board.

9.3.1.9 (Reserved)

9.3.1.10 Protection against the penetration of gases

9.3.1.10.1 The vessel shall be designed so as to prevent gases from penetrating into the accommodation and the service spaces.

9.3.1.10.2 Outside the cargo area, the lower edges of door-openings in the sidewalls of superstructures and the coamings of access hatches to under-deck spaces shall have a height of not less than 0.50 m above the deck

This requirement need not be complied with if the wall of the superstructures facing the cargo area extends from one side of the ship to the other and has doors the sills of which have a height of not less than 0.50 m. The height of this wall shall not be less than 2.00 m. In this case, the lower edges of door-openings in the sidewalls of superstructures and the coamings of access hatches behind this wall shall have a height of not less than 0.10 m. The sills of engine room doors and the coamings of its access hatches shall, however, always have a height of not less than 0.50 m.

9.3.1.10.3 In the cargo area, the lower edges of door-openings in the sidewalls of superstructures shall have a height of not less than 0.50 m above the deck and the sills of hatches and ventilation openings of premises located under the deck shall have a height of not less than 0.50 m above the deck. This requirement does not apply to access openings to double-hull and double bottom spaces.

9.3.1.10.4 The bulwarks, foot-rails, etc shall be provided with sufficiently large openings which are located directly above the deck.

9.3.1.11 Hold spaces and cargo tanks

9.3.1.11.1 (a) The maximum permissible capacity of a cargo tank shall be determined in accordance with the following table:

$L \times B \times H$ (m ³)	Maximum permissible capacity of a cargo tank (m ³)
up to 600	$L \times B \times H \times 0.3$
600 to 3 750	$180 + (L \times B \times H - 600) \times 0.0635$
> 3 750	380

Alternative constructions in accordance with 9.3.4 are permitted.

In the table above $L \times B \times H$ is the product of the main dimensions of the tank vessel in metres (according to the measurement certificate), where:

L = overall length of the hull in m;

B = extreme breadth of the hull in m;

H = shortest vertical distance between the top of the keel and the lowest point of the deck at the side of the vessel (moulded depth) within the cargo area in m;

where:

For trunk vessels, H shall be replaced by H', where H' shall be obtained from the following formula:

$$H' = H + \left(ht \times \frac{bt}{B} \times \frac{lt}{L} \right)$$

where:

ht = trunk height (distance between trunk deck and main deck measured on trunk side at L/2) in m;

bt = trunk breadth in m;

lt = trunk length in m;

(b) Pressure tanks whose ratio of length to diameter exceeds 7 are prohibited.

(c) The pressure tanks shall be designed for a cargo temperature of + 40 °C.

9.3.1.11.2 (a) In the cargo area, the hull shall be designed as follows:¹

– as a double-hull and double bottom vessel. The internal distance between the sideplatings of the vessel and the longitudinal bulkheads shall not be less than 0.80 m, the height of the double bottom shall be not less than 0.60 m, the cargo tanks shall be supported by saddles extending between the tanks to not less than 20° below the horizontal centreline of the cargo tanks.

Refrigerated cargo tanks shall be installed only in hold spaces bounded by double-hull spaces and double-bottom. Cargo tank fastenings shall meet the requirements of a recognised classification society; or

– as a single-hull vessel with the sideplatings of the vessel between gangboard and top of floor plates provided with side stringers at regular intervals of not more than 0.60 m which are supported by web frames spaced at intervals of not more than 2.00 m. The side stringers and the web frames shall have a height of not less than 10% of the depth, however, not less than 0.30 m. The side stringers and web frames shall be fitted with a face plate made of flat steel and having a cross-section of not less than 7.5 cm² and 15 cm², respectively.

The distance between the sideplating of the vessel and the cargo tanks shall be not less than 0.80 m and between the bottom and the cargo tanks not less than 0.60 m. The depth below the suction wells may be reduced to 0.50 m.

The lateral distance between the suction well of the cargo tanks and the bottom structure shall be not less than 0.10 m.

The cargo tank supports and fastenings should extend to not less than 10° below the horizontal centreline of the cargo tanks.

(b) The cargo tanks shall be fixed so that they cannot float.

(c) The capacity of a suction well shall be limited to not more than 0.10 m³. For pressure cargo tanks, however, the capacity of a suction well may be of 0.20 m³.

¹ For a different design of the hull in the cargo area, proof shall be furnished by way of calculation that in the event of a lateral collision with another vessel having a straight bow, an energy of 22 MJ can be absorbed without any rupture of the cargo tanks and the piping leading to the cargo tanks. Alternative constructions in accordance with 9.3.4 are permitted.

- (d) Side-struts linking or supporting the load-bearing components of the sides of the vessel with the load-bearing components of the longitudinal walls of cargo tanks and side-struts linking the load-bearing components of the vessel's bottom with the tank-bottom are prohibited.

- 9.3.1.11.3
- (a) The hold spaces shall be separated from the accommodation and service spaces outside the cargo area below deck by bulkheads provided with a Class A-60 fire protection insulation according to SOLAS 74, Chapter II-2, Regulation 3. A space of not less than 0.20 m shall be provided between the cargo tanks and the end bulkheads of the hold spaces. Where the cargo tanks have plane end bulkheads this space shall be not less than 0.50 m.
 - (b) The hold spaces and cargo tanks shall be capable of being inspected.
 - (c) All spaces in the cargo area shall be capable of being ventilated. Means for checking their gas-free condition shall be provided.

9.3.1.11.4 The bulkheads bounding the hold spaces shall be watertight. The cargo tanks and the bulkheads bounding the cargo area shall have no openings or penetrations below deck.

The bulkhead between the engine room and the service spaces within the cargo area or between the engine room and a hold space may be fitted with penetrations provided that they conform to the requirements of 9.3.1.17.5.

9.3.1.11.5 Double-hull spaces and double bottoms in the cargo area shall be arranged for being filled with ballast water only. Double bottoms may, however, be used as oil fuel tanks, provided they comply with the requirements of 9.3.1.32.

- 9.3.1.11.6
- (a) A space in the cargo area below deck may be arranged as a service space, provided that the bulkhead bounding the service space extends vertically to the bottom and the bulkhead not facing the cargo area extends from one side of the vessel to the other in one frame plane. This service space shall only be accessible from the deck.
 - (b) The service space shall be watertight with the exception of its access hatches and ventilation inlets.
 - (c) No piping for loading or unloading shall be fitted within the service space referred to under (a) above.

Piping for loading and unloading may be fitted in the cargo pump-rooms below deck only when they conform to the provisions of 9.3.1.17.6.

9.3.1.11.7 Where service spaces are located in the cargo area under deck, they shall be arranged so as to be easily accessible and to permit persons wearing protective clothing and breathing apparatus to safely operate the service equipment contained therein. They shall be designed so as to allow injured or unconscious personnel to be removed from such spaces without difficulty, if necessary by means of fixed equipment.

9.3.1.11.8 Hold spaces and other accessible spaces within the cargo area shall be arranged so as to ensure that they may be completely inspected and cleaned in an appropriate manner. The dimensions of openings, except for those of double-hull spaces and double bottoms which do not have a wall adjoining the cargo tanks, shall be sufficient to allow a person wearing breathing apparatus to enter or leave the space without difficulty. These openings shall have a minimum cross-sectional area of 0.36 m² and a minimum side length of 0.50 m. They shall be designed so as to allow injured or unconscious persons to be removed from the bottom of such spaces without difficulties, if necessary by means of fixed equipment. In

these spaces the distance between the reinforcements shall not be less than 0.50 m. In double bottoms this distance may be reduced to 0.45 m.

Cargo tanks may have circular openings with a diameter of not less than 0.68 m.

9.3.1.12 *Ventilation*

9.3.1.12.1 Each hold space shall have two openings the dimensions and location of which shall be such as to permit effective ventilation of any part of the hold space. If there are no such openings, it shall be possible to fill the hold spaces with inert gas or dry air.

9.3.1.12.2 Double-hull spaces and double bottoms within the cargo area which are not arranged for being filled with ballast water and cofferdams between engine rooms and pump-rooms, if they exist, shall be provided with ventilation systems.

9.3.1.12.3 Any service spaces located in the cargo area below deck shall be provided with a system of forced ventilation with sufficient power for ensuring at least 20 changes of air per hour based on the volume of the space.

The ventilation exhaust ducts shall extend down to 50 mm above the bottom of the service space. The air shall be supplied through a duct at the top of the service space. The air inlets shall be located not less than 2.00 m above the deck, at a distance of not less than 2.00 m from tank openings and 6.00 m from the outlets of safety valves.

The extension pipes, which may be necessary, may be of the hinged type.

9.3.1.12.4 Ventilation of accommodation and service spaces shall be possible.

9.3.1.12.5 Ventilators used in the cargo area shall be designed so that no sparks may be emitted on contact of the impeller blades with the housing and no static electricity may be generated.

9.3.1.12.6 Notice boards shall be fitted at the ventilation inlets indicating the conditions when they shall be closed. All ventilation inlets of accommodation and service spaces leading outside shall be fitted with fire flaps. Such ventilation inlets shall be located not less than 2.00 m from the cargo area.

Ventilation inlets of service spaces in the cargo area may be located within such area.

9.3.1.13 *Stability (general)*

9.3.1.13.1 Proof of sufficient stability shall be furnished including for stability in damaged condition.

9.3.1.13.2 The basic values for the stability calculation - the vessel's lightweight and location of the centre of gravity - shall be determined either by means of an inclining experiment or by detailed mass and moment calculation. In the latter case the lightweight of the vessel shall be checked by means of a lightweight test with a tolerance limit of $\pm 5\%$ between the mass determined by calculation and the displacement determined by the draught readings.

9.3.1.13.3 Proof of sufficient intact stability shall be furnished for all stages of loading and unloading and for the final loading condition for all the relative densities of the substances transported contained in the vessel substance list according to 1.16.1.2.5.

For every loading case, taking account of the actual fillings and floating position of cargo tanks, ballast tanks and compartments, drinking water and sewage tanks and tanks containing products for the operation of the vessel, the vessel shall comply with the intact and damage stability requirements.

Intermediate stages during operations shall also be taken into consideration.

The proof of sufficient stability shall be shown for every operating, loading and ballast condition in the stability booklet, to be approved by the relevant classification society, which classes the vessel. If it is unpractical to pre-calculate the operating, loading and ballast conditions, a loading instrument approved by the recognised classification society which classes the vessel shall be installed and used which contains the contents of the stability booklet.

NOTE: *A stability booklet shall be worded in a form comprehensible for the responsible master and containing the following details:*

General description of the vessel:

- *General arrangement and capacity plans indicating the assigned use of compartments and spaces (cargo tanks, stores, accommodation, etc.);*
- *A sketch indicating the position of the draught marks referring to the vessel's perpendiculars;*
- *A scheme for ballast/bilge pumping and overflow prevention systems;*
- *Hydrostatic curves or tables corresponding to the design trim, and, if significant trim angles are foreseen during the normal operation of the vessel, curves or tables corresponding to such range of trim are to be introduced;*
- *Cross curves or tables of stability calculated on a free trimming basis, for the ranges of displacement and trim anticipated in normal operating conditions, with an indication of the volumes which have been considered buoyant;*
- *Tank sounding tables or curves showing capacities, centres of gravity, and free surface data for all cargo tanks, ballast tanks and compartments, drinking water and sewage water tanks and tanks containing products for the operation of the vessel;*
- *Lightship data (weight and centre of gravity) resulting from an inclining test or deadweight measurement in combination with a detailed mass balance or other acceptable measures. Where the above-mentioned information is derived from a sister vessel, the reference to this sister vessel shall be clearly indicated, and a copy of the approved inclining test report relevant to this sister vessel shall be included;*
- *A copy of the approved test report shall be included in the stability booklet;*
- *Operating loading conditions with all relevant details, such as:*
 - *Lightship data, tank fillings, stores, crew and other relevant items on board (mass and centre of gravity for each item, free surface moments for liquid loads);*
 - *Draughts amidships and at perpendiculars;*
 - *Metacentric height corrected for free surfaces effect;*
 - *Righting lever values and curve;*
 - *Longitudinal bending moments and shear forces at read-out points;*
 - *Information about openings (location, type of tightness, means of closure);*
and
 - *Information for the master.*

- *Calculation of the influence of ballast water on stability with information on whether fixed level gauges for ballast tanks and compartments have to be installed or the ballast tanks, or compartments shall only be completely full or completely empty when underway.*

9.3.1.14 *Stability (intact)*

The requirements for intact stability resulting from the damaged stability calculation shall be fully complied with.

9.3.1.15 *Stability (damaged condition)*

9.3.1.15.1 The following assumptions shall be taken into consideration for the damaged condition:

(a) The extent of side damage is as follows:

longitudinal extent: at least 0.10 L, but not less than 5.00 m;
 transverse extent: 0.79 m, or when applicable, the distance allowed by section 9.3.4, reduced by 0.01 m;
 vertical extent: from the base line upwards without limit;

(b) The extent of bottom damage is as follows:

longitudinal extent: at least 0.10 L, but not less than 5.00 m;
 transverse extent: 3.00 m;
 vertical extent: from the base 0.59 m upwards, the well excepted;

(c) Any bulkheads within the damaged area shall be assumed damaged, which means that the location of bulkheads shall be chosen so as to ensure that the vessel remains afloat after the flooding of two or more adjacent compartments in the longitudinal direction.

The following provisions are applicable:

- For bottom damage, adjacent athwartship compartments shall also be assumed as flooded;
- The lower edge of any non-watertight openings (e.g. doors, windows, access hatchways) shall, at the final stage of flooding, be not less than 0.10 m above the damage waterline;
- In general, permeability shall be assumed to be 95%. Where an average permeability of less than 95% is calculated for any compartment, this calculated value obtained may be used.

However, the following minimum values shall be used:

- engine rooms: 85%;
- accommodation: 95%;
- double bottoms, oil fuel tanks, ballast tanks, etc., depending on whether, according to their function, they have to be assumed as full or empty for the vessel floating at the maximum permissible draught: 0% or 95%.

For the main engine room only the one-compartment standard need be taken into account, i.e. the end bulkheads of the engine room shall be assumed as not damaged.

- 9.3.1.15.2 At the stage of equilibrium (final stage of flooding), the angle of heel shall not exceed 12° . Non-watertight openings shall not be flooded before reaching the stage of equilibrium. If such openings are immersed before that stage, the corresponding spaces shall be considered as flooded for the purpose of stability calculation.

The positive range of the righting lever curve beyond the stage of equilibrium shall have a righting level of ≥ 0.05 m in association with an area under the curve of ≥ 0.0065 m.rad. The minimum values of stability shall be satisfied up to immersion of the first non-weather-tight opening and in any event up to an angle of heel $\leq 27^\circ$. If non-watertight openings are immersed before that stage, the corresponding spaces shall be considered as flooded for the purpose of stability calculation.

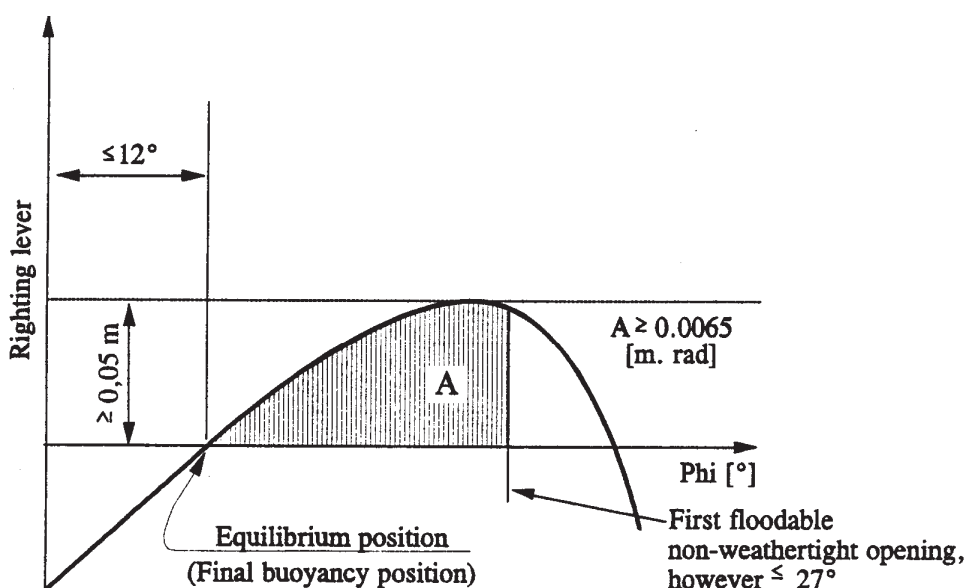

- 9.3.1.15.3 If openings through which undamaged compartments may additionally become flooded are capable of being closed watertight, the closing appliances shall be marked accordingly.

- 9.3.1.15.4 When cross- or down-flooding openings are provided for reduction of unsymmetrical flooding, the time for equalisation shall not exceed 15 minutes, if during the intermediate stages of flooding sufficient stability has been proved.

9.3.1.16 *Engine rooms*

- 9.3.1.16.1 Internal combustion engines for the vessel's propulsion as well as internal combustion engines for auxiliary machinery shall be located outside the cargo area. Entrances and other openings of engine rooms shall be at a distance of not less than 2.00 m from the cargo area.

- 9.3.1.16.2 The engine room shall be accessible from the deck; the entrances shall not face the cargo area. When the doors are not located in a recess whose depth is at least equal to the door width, the hinges shall face the cargo area.

9.3.1.17 *Accommodation and service spaces*

9.3.1.17.1 Accommodation spaces and the wheelhouse shall be located outside the cargo area forward of the fore vertical plane or abaft the aft vertical plane bounding the part of the cargo area below deck. Windows of the wheelhouse which are located not less than 1.00 m above the bottom of the wheelhouse may tilt forward.

9.3.1.17.2 Entrances to spaces and openings of superstructures shall not face the cargo area. Doors opening outward and not located in a recess the depth of which is at least equal to the width of the doors shall have their hinges facing the cargo area.

9.3.1.17.3 Entrances from the deck and openings of spaces facing the weather shall be capable of being closed. The following instruction shall be displayed at the entrance of such spaces:

**Do not open during loading and unloading without
the permission of the master.
Close immediately.**

9.3.1.17.4 Entrances and windows of superstructures and accommodation spaces which can be opened as well as other openings of these spaces shall be located not less than 2.00 m from the cargo area. No wheelhouse doors and windows shall be located within 2.00 m from the cargo area, except where there is no direct connection between the wheelhouse and the accommodation.

9.3.1.17.5 (a) Driving shafts of the bilge or ballast pumps may penetrate through the bulkhead between the service space and the engine room, provided the arrangement of the service space is in compliance with 9.3.1.11.6.

(b) The penetration of the shaft through the bulkhead shall be gastight and shall have been approved by a recognised classification society.

(c) The necessary operating instructions shall be displayed.

(d) Penetrations through the bulkhead between the engine room and the service space in the cargo area, and the bulkhead between the engine room and the hold spaces may be provided for electrical cables, hydraulic lines and piping for measuring, control and alarm systems, provided that the penetrations have been approved by a recognised classification society. The penetrations shall be gastight. Penetrations through a bulkhead with an "A-60" fire protection insulation according to SOLAS 74, Chapter II-2, Regulation 3, shall have an equivalent fire protection.

(e) Pipes may pass through the bulkhead between the engine room and the service space in the cargo area provided that these are pipes between the mechanical equipment in the engine room and the service space which do not have any openings within the service space and which are provided with shut-off devices at the bulkhead in the engine room.

(f) Notwithstanding 9.3.1.11.4, pipes from the engine room may pass through the service space in the cargo area or a cofferdam or a hold space or a double-hull space to the outside provided that within the service space or cofferdam or hold space or double-hull space they are of the thick-walled type and have no flanges or openings.

(g) Where a driving shaft of auxiliary machinery penetrates through a wall located above the deck the penetration shall be gastight.

9.3.1.17.6 A service space located within the cargo area below deck shall not be used as a cargo pump-room for the vessel's own gas discharging system, e.g. compressors or the compressor/heat exchanger/pump combination, except where:

- the pump-room is separated from the engine room or from service spaces outside the cargo area by a cofferdam or a bulkhead with an “A-60” fire protection insulation according to SOLAS 74, Chapter II-2, Regulation 3, or by a service space or a hold space;
- the “A-60” bulkhead required above does not include penetrations referred to in 9.3.1.17.5 (a);
- ventilation exhaust outlets are located not less than 6.00 m from entrances and openings of the accommodation and service spaces;
- the access hatches and ventilation inlets can be closed from the outside;
- all piping for loading and unloading (at the suction side and delivery side) are led through the deck above the pump-room. The necessary operation of the control devices in the pump-room, starting of pumps or compressors and necessary control of the liquid flow rate shall be effected from the deck;
- the system is fully integrated in the gas and liquid piping system;
- the cargo pump-room is provided with a permanent gas detection system which automatically indicates the presence of explosive gases or lack of oxygen by means of direct-measuring sensors and which actuates a visual and audible alarm when the gas concentration has reached 20% of the lower explosive limit. The sensors of this system shall be placed at suitable positions at the bottom and directly below the deck.

Measurement shall be continuous.

The audible and visual alarms are installed in the wheelhouse and in the cargo pump-room and, when the alarm is actuated, the loading and unloading system is shut down. Failure of the gas detection system shall be immediately signalled in the wheelhouse and on deck by means of audible and visual alarms;

- the ventilation system prescribed in 9.3.1.12.3 has a capacity of not less than 30 changes of air per hour based on the total volume of the service space.

9.3.1.17.7 The following instruction shall be displayed at the entrance of the cargo pump-room:

**Before entering the cargo pump-room check whether
it is free from gases and contains sufficient oxygen.
Do not open doors and entrance openings without
the permission of the master.
Leave immediately in the event of alarm.**

9.3.1.18 *Inerting facility*

In cases in which inerting or blanketing of the cargo is prescribed, the vessel shall be equipped with an inerting system.

This system shall be capable of maintaining a permanent minimum pressure of 7 kPa (0.07 bar) in the spaces to be inerted. In addition, the inerting system shall not increase the pressure in the cargo tank to a pressure greater than that at which the pressure valve is

regulated. The set pressure of the vacuum-relief valve shall be 3.5 kPa (0.035 bar).

A sufficient quantity of inert gas for loading or unloading shall be carried or produced on board if it is not possible to obtain it on shore. In addition, a sufficient quantity of inert gas to offset normal losses occurring during carriage shall be on board.

The premises to be inerted shall be equipped with connections for introducing the inert gas and monitoring systems so as to ensure the correct atmosphere on a permanent basis.

When the pressure or the concentration of inert gas in the gaseous phase falls below a given value, this monitoring system shall activate an audible and visible alarm in the wheelhouse. When the wheelhouse is unoccupied, the alarm shall also be perceptible in a location occupied by a crew member.

9.3.1.19-
9.3.1.20 (Reserved)

9.3.1.21 *Safety and control installations*

9.3.1.21.1 Cargo tanks shall be provided with the following equipment:

- (a) (Reserved);
- (b) a level gauge;
- (c) a level alarm device which is activated at the latest when a degree of filling of 86% is reached;
- (d) a high level sensor for actuating the facility against overflowing at the latest when a degree of filling of 97.5% is reached;
- (e) an instrument for measuring the pressure of the gas phase in the cargo tank;
- (f) an instrument for measuring the temperature of the cargo;
- (g) a connection for a closed sampling device.

9.3.1.21.2 When the degree of filling in per cent is determined, an error of not more than 0.5% is permitted. It shall be calculated on the basis of the total cargo tank capacity including the expansion trunk.

9.3.1.21.3 The level gauge shall allow readings from the control position of the shut-off devices of the particular cargo tank. The permissible maximum filling level of the cargo tank shall be marked on each level gauge.

Permanent reading of the overpressure and vacuum shall be possible from a location from which loading or unloading operations may be interrupted. The permissible maximum overpressure and vacuum shall be marked on each level gauge.

Readings shall be possible in all weather conditions.

9.3.1.21.4 The level alarm device shall give a visual and audible warning on board when actuated. The level alarm device shall be independent of the level gauge.

- 9.3.1.21.5 (a) The high level sensor referred to in 9.3.1.21.1 (d) shall give a visual and audible alarm on board and at the same time actuate an electrical contact which in the form of a binary signal interrupts the electric current loop provided and fed by the shore facility, thus initiating measures at the shore facility against overflowing during loading operations.

The signal shall be transmitted to the shore facility via a watertight two-pin plug of a connector device in accordance with standard EN 60309-2:1999 for direct current of 40 to 50 volts, identification colour white, position of the nose 10 h.

The plug shall be permanently fitted to the vessel close to the shore connections of the loading and unloading piping.

The high level sensor shall also be capable of switching off the vessel's own discharging pump.

The high level sensor shall be independent of the level alarm device, but it may be connected to the level gauge.

- (b) During discharging by means of the on-board pump, it shall be possible for the shore facility to switch it off. For this purpose, an independent intrinsically safe power line, fed by the vessel, shall be switched off by the shore facility by means of an electrical contact.

It shall be possible for the binary signal of the shore facility to be transmitted via a watertight two-pole socket or a connector device in accordance with standard EN 60309-2:1999, for direct current of 40 to 50 volts, identification colour white, position of the nose 10 h.

This socket shall be permanently fitted to the vessel close to the shore connections of the unloading piping.

- 9.3.1.21.6 The visual and audible signals given by the level alarm device shall be clearly distinguishable from those of the high level sensor.

The visual alarm shall be visible at each control position on deck of the cargo tank stop valves. It shall be possible to easily check the functioning of the sensors and electric circuits or these shall be of the "failsafe" design.

- 9.3.1.21.7 When the pressure or the temperature exceeds a set value, the instruments for measuring the pressure and the temperature of the cargo shall activate a visual and an audible alarm in the wheelhouse. When the wheelhouse is unoccupied the alarm shall also be perceptible in a location occupied by a crew member.

When the pressure exceeds a set value during loading or unloading, the instrument for measuring the pressure shall simultaneously initiate an electrical contact which, by means of the plug referred to in 9.3.1.21.5 above, enables measures to be taken to interrupt the loading and unloading operation. When the vessel's own discharge pump is used, it shall be switched off automatically. The sensor for the alarms referred to above may be connected to the alarm installation.

- 9.3.1.21.8 Where the control elements of the shut-off devices of the cargo tanks are located in a control room, it shall be possible to stop the loading pumps and read the level gauges in the control room, and the visual and audible warning given by the level alarm device, the high level sensor referred to in 9.3.1.21.1 (d) and the instruments for measuring the pressure and temperature of the cargo shall be noticeable in the control room and on deck.

Satisfactory monitoring of the cargo area shall be ensured from the control room.

- 9.3.1.21.9 The vessel shall be so equipped that loading or unloading operations can be interrupted by means of switches, i.e. the quick-action stop valve located on the flexible vessel-to-shore connecting line must be capable of being closed. The switches shall be placed at two points on the vessel (fore and aft).

The interruption systems shall be designed according to the quiescent current principle.

- 9.3.1.21.10 When refrigerated substances are carried the opening pressure of the safety system shall be determined by the design of the cargo tanks. In the event of the transport of substances that must be carried in a refrigerated state the opening pressure of the safety system shall be not less than 25 kPa (0.25 bar) greater than the maximum pressure calculated according to 9.3.1.27.

9.3.1.22 *Cargo tank openings*

- 9.3.1.22.1 (a) Cargo tank openings shall be located on deck in the cargo area.
- (b) Cargo tank openings with a cross-section greater than 0.10 m² shall be located not less than 0.50 m above the deck.
- 9.3.1.22.2 Cargo tank openings shall be fitted with gastight closures which comply with the provisions of 9.3.1.23.1.
- 9.3.1.22.3 The exhaust outlets of the pressure relief valves shall be located not less than 2.00 m above the deck at a distance of not less than 6.00 m from the accommodation and from the service spaces located outside the cargo area. This height may be reduced when within a radius of 1.00 m round the pressure relief valve outlet there is no equipment, no work is being carried out and signs indicate the area.
- 9.3.1.22.4 The closing devices normally used in loading and unloading operations shall not be capable of producing sparks when operated.
- 9.3.1.22.5 Each tank in which refrigerated substances are carried shall be equipped with a safety system to prevent unauthorized vacuum or overpressure.

9.3.1.23 *Pressure test*

- 9.3.1.23.1 Cargo tanks and piping for loading and unloading shall comply with the provisions concerning pressure vessels which have been established by the competent authority or a recognised classification society for the substances carried.
- 9.3.1.23.2 Any cofferdams shall be subjected to initial tests before being put into service and thereafter at the prescribed intervals.

The test pressure shall be not less than 10 kPa (0.10 bar) gauge pressure.

- 9.3.1.23.3 The maximum intervals for the periodic tests referred to in 9.3.1.23.2 above shall be 11 years.

9.3.1.24 *Regulation of cargo pressure and temperature*

- 9.3.1.24.1 Unless the entire cargo system is designed to resist the full effective vapour pressure of the cargo at the upper limits of the ambient design temperatures, the pressure of the tanks shall

be kept below the permissible maximum set pressure of the safety valves, by one or more of the following means:

- (a) a system for the regulation of cargo tank pressure using mechanical refrigeration;
- (b) a system ensuring safety in the event of the heating or increase in pressure of the cargo. The insulation or the design pressure of the cargo tank, or the combination of these two elements, shall be such as to leave an adequate margin for the operating period and the temperatures expected; in each case the system shall be deemed acceptable by a recognized classification society and shall ensure safety for a minimum time of three times the operation period;
- (c) other systems deemed acceptable by a recognized classification society.

9.3.1.24.2 The systems prescribed in 9.3.1.24.1 shall be constructed, installed and tested to the satisfaction of the recognized classification society. The materials used in their construction shall be compatible with the cargoes to be carried. For normal service, the upper ambient design temperature limits shall be:

air: +30° C;

water: +20° C.

9.3.1.24.3 The cargo storage system shall be capable of resisting the full vapour pressure of the cargo at the upper limits of the ambient design temperatures, whatever the system adopted to deal with the boil-off gas. This requirement is indicated by remark 37 in column (20) of Table C of Chapter 3.2.

9.3.1.25 *Pumps and piping*

9.3.1.25.1 Pumps, compressors and accessory loading and unloading piping shall be placed in the cargo area. Cargo pumps and compressors shall be capable of being shut down from the cargo area and, in addition, from a position outside the cargo area. Cargo pumps and compressors situated on deck shall be located not less than 6.00 m from entrances to, or openings of, the accommodation and service spaces outside the cargo area.

9.3.1.25.2 (a) Piping for loading and unloading shall be independent of any other piping of the vessel. No cargo piping shall be located below deck, except those inside the cargo tanks and in the service spaces intended for the installation of the vessel's own gas discharging system.

(b) *(Reserved)*

(c) Piping for loading and unloading shall be clearly distinguishable from other piping, e.g. by means of colour marking.

(d) The piping for loading and unloading on deck, the vapour pipes with the exception of the shore connections but including the safety valves, and the valves shall be located within the longitudinal line formed by the outer boundaries of the domes and not less than one quarter of the vessel's breadth from the outer shell. This requirement does not apply to the relief pipes situated behind the safety valves. If there is, however, only one dome athwartships, these pipes and their valves shall be located at a distance not less than 2.70 m from the shell.

Where cargo tanks are placed side by side, all the connections to the domes shall be located on the inner side of the domes. The external connections may be located on the

fore and aft centre line of the dome. The shut-off devices shall be located directly at the dome or as close as possible to it. The shut-off devices of the loading and unloading piping shall be duplicated, one of the devices being constituted by a remote-controlled quick-action stop device. When the inside diameter of a shut-off device is less than 50 mm this device may be regarded as a safety device against bursts in the piping.

- (e) The shore connections shall be located not less than 6.00 m from the entrances to or openings of, the accommodation and service spaces outside the cargo area.
- (f) Each shore connection of the vapour pipe and shore connections of the piping for loading and unloading, through which the loading or unloading operation is carried out, shall be fitted with a shut-off device and a quick-action stop valve. However, each shore connection shall be fitted with a blind flange when it is not in operation.
- (g) Piping for loading and unloading, and vapour pipes, shall not have flexible connections fitted with sliding seals.

9.3.1.25.3 The distance referred to in 9.3.1.25.1 and 9.3.1.25.2 (e) may be reduced to 3.00 m if a transverse bulkhead complying with 9.3.1.10.2 is situated at the end of the cargo area. The openings shall be provided with doors.

The following notice shall be displayed on the doors:

**Do not open during loading and unloading without
the permission of the master.
Close immediately.**

9.3.1.25.4 Every component of the piping for loading and unloading shall be electrically connected to the hull.

9.3.1.25.5 The stop valves or other shut-off devices of the piping for loading and unloading shall indicate whether they are open or shut.

9.3.1.25.6 The piping for loading and unloading shall have, at the test pressure, the required elasticity, leakproofness and resistance to pressure.

9.3.1.25.7 The piping for unloading shall be fitted with pressure gauges at the inlet and outlet of the pump.

Reading of the pressure gauges shall be possible from the control position of the vessel's own gas discharging system. The maximum permissible overpressure or vacuum shall be indicated by a measuring device.

Readings shall be possible in all weather conditions.

9.3.1.25.8 Use of the cargo piping for ballasting purposes shall not be possible.

9.3.1.26 (*Reserved*)

9.3.1.27 *Refrigeration system*

9.3.1.27.1 The refrigeration system referred to in 9.3.1.24.1 (a) shall be composed of one or more units capable of keeping the pressure and temperature of the cargo at the upper limits of the ambient design temperatures at the prescribed level. Unless another means of regulating cargo pressure and temperature deemed satisfactory by a recognized classification society is

provided, provision shall be made for one or more stand-by units with an output at least equal to that of the largest prescribed unit. A stand-by unit shall include a compressor, its engine, its control system and all necessary accessories to enable it to operate independently of the units normally used. Provision shall be made for a stand-by heat-exchanger unless the system's normal heat-exchanger has a surplus capacity equal to at least 25% of the largest prescribed capacity. It is not necessary to make provision for separate piping.

Cargo tanks, piping and accessories shall be insulated so that, in the event of a failure of all cargo refrigeration systems, the entire cargo remains for at least 52 hours in a condition not causing the safety valves to open.

9.3.1.27.2 The security devices and the connecting lines from the refrigeration system shall be connected to the cargo tanks above the liquid phase of the cargo when the tanks are filled to their maximum permissible degree of filling. They shall remain within the gaseous phase, even if the vessel has a list up to 12 degrees.

9.3.1.27.3 When several refrigerated cargoes with a potentially dangerous chemical reaction are carried simultaneously, particular care shall be given to the refrigeration systems so as to prevent any mixing of the cargoes. For the carriage of such cargoes, separate refrigeration systems, each including the full stand-by unit referred to in 9.3.1.27.1, shall be provided for each cargo. When, however, refrigeration is ensured by an indirect or combined system and no leak in the heat exchangers can under any foreseeable circumstances lead to the mixing of cargoes, no provision need be made for separate refrigeration units for the different cargoes.

9.3.1.27.4 When several refrigerated cargoes are not soluble in each other under conditions of carriage such that their vapour pressures are added together in the event of mixing, particular care shall be given to the refrigeration systems to prevent any mixing of the cargoes.

9.3.1.27.5 When the refrigeration systems require water for cooling, a sufficient quantity shall be supplied by a pump or pumps used exclusively for the purpose. This pump or pumps shall have at least two suction pipes, leading from two water intakes, one to port, the other to starboard. Provision shall be made for a stand-by pump with a satisfactory flow; this may be a pump used for other purposes provided that its use for supplying water for cooling does not impair any other essential service.

9.3.1.27.6 The refrigeration system may take one of the following forms:

- (a) Direct system: the cargo vapours are compressed, condensed and returned to the cargo tanks. This system shall not be used for certain cargoes specified in Table C of Chapter 3.2. This requirement is indicated by remark 35 in column (20) of Table C of Chapter 3.2;
- (b) Indirect system: the cargo or the cargo vapours are cooled or condensed by means of a coolant without being compressed;
- (c) Combined system: the cargo vapours are compressed and condensed in a cargo/coolant heat-exchanger and returned to the cargo tanks. This system shall not be used for certain cargoes specified in Table C of Chapter 3.2. This requirement is indicated by remark 36 in column (20) of Table C of Chapter 3.2.

9.3.1.27.7 All primary and secondary coolant fluids shall be compatible with each other and with the cargo with which they may come into contact. Heat exchange may take place either at a distance from the cargo tank, or by using cooling coils attached to the inside or the outside of the cargo tank.

- 9.3.1.27.8 When the refrigeration system is installed in a separate service space, this service space shall meet the requirements of 9.3.1.17.6.
- 9.3.1.27.9 For all cargo systems, the heat transmission coefficient shall be determined by calculation. The correctness of the calculation shall be checked by means of a refrigeration test (heat balance test).
- This test shall be performed in accordance with the rules set up by a recognised classification society.
- 9.3.1.27.10 A certificate from a recognized classification society stating that 9.3.1.24.1 to 9.3.1.24.3, 9.2.1.27.1 and 9.3.1.27.4 above have been complied with shall be submitted together with the application for issue or renewal of the certificate of approval.

9.3.1.28 *Water-spray system*

When water-spraying is required in column (9) of Table C of Chapter 3.2 a water-spray system shall be installed in the cargo area on deck for the purpose of reducing gases given off by the cargo by spraying water.

The system shall be fitted with a connection device for supply from the shore. The spray nozzles shall be so installed that released gases are precipitated safely. The system shall be capable of being put into operation from the wheelhouse and from the deck. The capacity of the water-spray system shall be such that when all the spray nozzles are in operation, the outflow is of 50 litres per square metre of cargo deck area and per hour.

9.3.1.29-
9.3.1.30 (*Reserved*)

9.3.1.31 *Engines*

- 9.3.1.31.1 Only internal combustion engines running on fuel with a flashpoint of more than 55 °C are allowed.
- 9.3.1.31.2 Ventilation inlets of the engine room and, when the engines do not take in air directly from the engine room, the air intakes of the engines shall be located not less than 2.00 m from the cargo area.
- 9.3.1.31.3 Sparking shall not be possible within the cargo area.
- 9.3.1.31.4 The surface temperature of the outer parts of engines used during loading or unloading operations, as well as that of their air inlets and exhaust ducts shall not exceed the allowable temperature according to the temperature class of the substances carried. This provision does not apply to engines installed in service spaces provided the provisions of 9.3.1.52.3 are fully complied with.
- 9.3.1.31.5 The ventilation in the closed engine room shall be designed so that, at an ambient temperature of 20 °C, the average temperature in the engine room does not exceed 40 °C.

9.3.1.32 *Oil fuel tanks*

- 9.3.1.32.1 When the vessel is fitted with hold spaces and double bottoms, double bottoms within the cargo area may be arranged as oil fuel tanks, provided their depth is not less than 0.6 m.

Oil fuel pipes and openings of such tanks are not permitted in the hold space.

9.3.1.32.2 Open ends of air pipes of all oil fuel tanks shall extend to not less than 0.5 m above the open deck. The open ends and the open ends of overflow pipes leading to the deck shall be fitted with a protective device consisting of a gauze diaphragm or a perforated plate.

9.3.1.33 *(Reserved)*

9.3.1.34 *Exhaust pipes*

9.3.1.34.1 Exhausts shall be evacuated from the vessel into the open air either upwards through an exhaust pipe or through the shell plating. The exhaust outlet shall be located not less than 2 m from the cargo area. The exhaust pipes of engines shall be arranged so that the exhausts are led away from the vessel. The exhaust pipes shall not be located within the cargo area.

9.3.1.34.2 Exhaust pipes of engines shall be provided with a device preventing the escape of sparks, e.g. spark arresters.

9.3.1.35 *Bilge pumping and ballasting arrangements*

9.3.1.35.1 Bilge and ballast pumps for spaces within the cargo area shall be installed within such area.

This provision does not apply to:

- double-hull spaces and double bottoms which do not have a common boundary wall with the cargo tanks;
- cofferdams and hold spaces where ballasting is carried out using the piping of the fire-fighting system in the cargo area and bilge-pumping is performed using eductors.

9.3.1.35.2 Where the double bottom is used as a liquid oil fuel tank, it shall not be connected to the bilge piping system.

9.3.1.35.3 Where the ballast pump is installed in the cargo area, the standpipe and its outboard connection for suction of ballast water shall be located within the cargo area.

9.3.1.35.4 It shall be possible for an under-deck pump-room to be stripped in an emergency using a system located in the cargo area and independent of any other system. This stripping system shall be located outside the pump-room.

9.3.1.36-
9.3.1.39 *(Reserved)*

9.3.1.40 *Fire-extinguishing arrangements*

9.3.1.40.1 A fire-extinguishing system shall be installed on the vessel.

This system shall comply with the following requirements:

- It shall be supplied by two independent fire or ballast pumps, one of which shall be ready for use at any time. These pumps and their means of propulsion and electrical equipment shall not be installed in the same space;
- It shall be provided with a water main fitted with at least three hydrants in the cargo area above deck. Three suitable and sufficiently long hoses with jet/spray nozzles having a diameter of not less than 12 mm shall be provided. Alternatively one or more of the hose assemblies may be substituted by directable jet/spray nozzles having a

diameter of not less than 12 mm. It shall be possible to reach any point of the deck in the cargo area simultaneously with at least two jets of water which do not emanate from the same hydrant.

A spring-loaded non-return valve shall be fitted to ensure that no gases can escape through the fire-extinguishing system into the accommodation or service spaces outside the cargo area;

- The capacity of the system shall be at least sufficient for a jet of water to have a minimum reach of not less than the vessel's breadth from any location on board with two spray nozzles being used at the same time;
- The water supply system shall be capable of being put into operation from the wheelhouse and from the deck;
- Measures shall be taken to prevent the freezing of fire-mains and hydrants.

9.3.1.40.2 In addition the engine rooms, the cargo pump-room and all spaces containing special equipment (switchboards, compressors, etc.) for the refrigerant equipment if any, shall be provided with a permanently fixed fire-extinguishing system meeting the following requirements:

9.3.1.40.2.1 *Extinguishing agents*

For the protection of spaces in engine rooms, boiler rooms and pump rooms, only permanently fixed fire-extinguishing systems using the following extinguishing agents are permitted:

- (a) CO₂ (carbon dioxide);
- (b) HFC 227 ea (heptafluoropropane);
- (c) IG-541 (52% nitrogen, 40% argon, 8% carbon dioxide).
- (d) FK-5-1-12 (dodecafluoro 2-methylpentane-3-one).

Other extinguishing agents are permitted only on the basis of recommendations by the Administrative Committee.

9.3.1.40.2.2 *Ventilation, air extraction*

- (a) The combustion air required by the combustion engines which ensure propulsion should not come from spaces protected by permanently fixed fire-extinguishing systems. This requirement is not mandatory if the vessel has two independent main engine rooms with a gastight separation or if, in addition to the main engine room, there is a separate engine room installed with a bow thruster that can independently ensure propulsion in the event of a fire in the main engine room.
- (b) All forced ventilation systems in the space to be protected shall be shut down automatically as soon as the fire-extinguishing system is activated.
- (c) All openings in the space to be protected which permit air to enter or gas to escape shall be fitted with devices enabling them to be closed rapidly. It shall be clear whether they are open or closed.

- (d) Air escaping from the pressure-relief valves of the pressurised air tanks installed in the engine rooms shall be evacuated to the open air.
- (e) Overpressure or negative pressure caused by the diffusion of the extinguishing agent shall not destroy the constituent elements of the space to be protected. It shall be possible to ensure the safe equalisation of pressure.
- (f) Protected spaces shall be provided with a means of extracting the extinguishing agent. If extraction devices are installed, it shall not be possible to start them up during extinguishing.

9.3.1.40.2.3 *Fire alarm system*

The space to be protected shall be monitored by an appropriate fire alarm system. The alarm signal shall be audible in the wheelhouse, the accommodation and the space to be protected.

9.3.1.40.2.4 *Piping system*

- (a) The extinguishing agent shall be routed to and distributed in the space to be protected by means of a permanent piping system. Piping installed in the space to be protected and the reinforcements it incorporates shall be made of steel. This shall not apply to the connecting nozzles of tanks and compensators provided that the materials used have equivalent fire-retardant properties. Piping shall be protected against corrosion both internally and externally.
- (b) The discharge nozzles shall be so arranged as to ensure the regular diffusion of the extinguishing agent. In particular, the extinguishing agent must also be effective beneath the floor.

9.3.1.40.2.5 *Triggering device*

- (a) Automatically activated fire-extinguishing systems are not permitted.
- (b) It shall be possible to activate the fire-extinguishing system from a suitable point located outside the space to be protected.
- (c) Triggering devices shall be so installed that they can be activated in the event of a fire and so that the risk of their breakdown in the event of a fire or an explosion in the space to be protected is reduced as far as possible.

Systems which are not mechanically activated shall be supplied from two energy sources independent of each other. These energy sources shall be located outside the space to be protected. The control lines located in the space to be protected shall be so designed as to remain capable of operating in the event of a fire for a minimum of 30 minutes. The electrical installations are deemed to meet this requirement if they conform to the IEC 60331-21:1999 standard.

When the triggering devices are so placed as not to be visible, the component concealing them shall carry the "Fire-fighting system" symbol, each side being not less than 10 cm in length, with the following text in red letters on a white ground:

Fire-extinguishing system

- (d) If the fire-extinguishing system is intended to protect several spaces, it shall comprise a separate and clearly-marked triggering device for each space.

- (e) The instructions shall be posted alongside all triggering devices and shall be clearly visible and indelible. The instructions shall be in a language the master can read and understand and if this language is not English, French or German, they shall be in English, French or German. They shall include information concerning:
 - (i) the activation of the fire-extinguishing system;
 - (ii) the need to ensure that all persons have left the space to be protected;
 - (iii) The correct behaviour of the crew in the event of activation and when accessing the space to be protected following activation or diffusion, in particular in respect of the possible presence of dangerous substances;
 - (iv) the correct behaviour of the crew in the event of the failure of the fire-extinguishing system to function properly.
- (f) The instructions shall mention that prior to the activation of the fire-extinguishing system, combustion engines installed in the space and aspirating air from the space to be protected, shall be shut down.

9.3.1.40.2.6 *Alarm device*

- (a) Permanently fixed fire-extinguishing systems shall be fitted with an audible and visual alarm device.
- (b) The alarm device shall be set off automatically as soon as the fire-extinguishing system is first activated. The alarm device shall function for an appropriate period of time before the extinguishing agent is released; it shall not be possible to turn it off.
- (c) Alarm signals shall be clearly visible in the spaces to be protected and their access points and be clearly audible under operating conditions corresponding to the highest possible sound level. It shall be possible to distinguish them clearly from all other sound and visual signals in the space to be protected.
- (d) Sound alarms shall also be clearly audible in adjoining spaces, with the communicating doors shut, and under operating conditions corresponding to the highest possible sound level.
- (e) If the alarm device is not intrinsically protected against short circuits, broken wires and drops in voltage, it shall be possible to monitor its operation.
- (f) A sign with the following text in red letters on a white ground shall be clearly posted at the entrance to any space the extinguishing agent may reach:

Warning, fire-extinguishing system!
Leave this space immediately when the ... (description) alarm is activated!

9.3.1.40.2.7 *Pressurised tanks, fittings and piping*

- (a) Pressurised tanks, fittings and piping shall conform to the requirements of the competent authority.
- (b) Pressurised tanks shall be installed in accordance with the manufacturer's instructions.
- (c) Pressurised tanks, fittings and piping shall not be installed in the accommodation.

- (d) The temperature of cabinets and storage spaces for pressurised tanks shall not exceed 50 °C.
- (e) Cabinets or storage spaces on deck shall be securely stowed and shall have vents so placed that in the event of a pressurised tank not being gastight, the escaping gas cannot penetrate into the vessel. Direct connections with other spaces are not permitted.

9.3.1.40.2.8 *Quantity of extinguishing agent*

If the quantity of extinguishing agent is intended for more than one space, the quantity of extinguishing agent available does not need to be greater than the quantity required for the largest of the spaces thus protected.

9.3.1.40.2.9 *Installation, maintenance, monitoring and documents*

- (a) The mounting or modification of the system shall only be performed by a company specialised in fire-extinguishing systems. The instructions (product data sheet, safety data sheet) provided by the manufacturer of the extinguishing agent or the system shall be followed.
- (b) The system shall be inspected by an expert:
 - (i) before being brought into service;
 - (ii) each time it is put back into service after activation;
 - (iii) after every modification or repair;
 - (iv) regularly, not less than every two years.
- (c) During the inspection, the expert is required to check that the system conforms to the requirements of 9.3.1.40.2.
- (d) The inspection shall include, as a minimum:
 - (i) an external inspection of the entire system;
 - (ii) an inspection to ensure that the piping is leakproof;
 - (iii) an inspection to ensure that the control and activation systems are in good working order;
 - (iv) an inspection of the pressure and contents of tanks;
 - (v) an inspection to ensure that the means of closing the space to be protected are leakproof;
 - (vi) an inspection of the fire alarm system;
 - (vii) an inspection of the alarm device.
- (e) The person performing the inspection shall establish, sign and date a certificate of inspection.

- (f) The number of permanently fixed fire-extinguishing systems shall be mentioned in the inspection certificate.

9.3.1.40.2.10 *Fire-extinguishing system operating with CO₂*

In addition to the requirements contained in 9.3.1.40.2.1 to 9.3.1.40.2.9, fire-extinguishing systems using CO₂ as an extinguishing agent shall conform to the following provisions:

- (a) Tanks of CO₂ shall be placed in a gastight space or cabinet separated from other spaces. The doors of such storage spaces and cabinets shall open outwards; they shall be capable of being locked and shall carry on the outside the symbol “Warning: general danger”, not less than 5 cm high and “CO₂” in the same colours and the same size;
- (b) Storage cabinets or spaces for CO₂ tanks located below deck shall only be accessible from the outside. These spaces shall have an artificial ventilation system with extractor hoods and shall be completely independent of the other ventilation systems on board;
- (c) The level of filling of CO₂ tanks shall not exceed 0.75 kg/l. The volume of depressurised CO₂ shall be taken to be 0.56 m³/kg;
- (d) The concentration of CO₂ in the space to be protected shall be not less than 40% of the gross volume of the space. This quantity shall be released within 120 seconds. It shall be possible to monitor whether diffusion is proceeding correctly;
- (e) The opening of the tank valves and the control of the diffusing valve shall correspond to two different operations;
- (f) The appropriate period of time mentioned in 9.3.1.40.2.6 (b) shall be not less than 20 seconds. A reliable installation shall ensure the timing of the diffusion of CO₂.

9.3.1.40.2.11 *Fire-extinguishing system operating with HFC-227 ea (heptafluoropropane)*

In addition to the requirements of 9.3.1.40.2.1 to 9.3.1.40.2.9, fire-extinguishing systems using HFC-227 ea as an extinguishing agent shall conform to the following provisions:

- (a) Where there are several spaces with different gross volumes, each space shall be equipped with its own fire-extinguishing system;
- (b) Every tank containing HFC-227 ea placed in the space to be protected shall be fitted with a device to prevent overpressure. This device shall ensure that the contents of the tank are safely diffused in the space to be protected if the tank is subjected to fire, when the fire-extinguishing system has not been brought into service;
- (c) Every tank shall be fitted with a device permitting control of the gas pressure;
- (d) The level of filling of tanks shall not exceed 1.15 kg/l. The specific volume of depressurised HFC-227 ea shall be taken to be 0.1374 m³/kg;
- (e) The concentration of HFC-227 ea in the space to be protected shall be not less than 8% of the gross volume of the space. This quantity shall be released within 10 seconds;
- (f) Tanks of HFC-227 ea shall be fitted with a pressure monitoring device which triggers an audible and visual alarm in the wheelhouse in the event of an unscheduled loss of

propellant gas. Where there is no wheelhouse, the alarm shall be triggered outside the space to be protected;

- (g) After discharge, the concentration in the space to be protected shall not exceed 10.5% (volume);
- (h) The fire-extinguishing system shall not comprise aluminium parts.

9.3.1.40.2.12 *Fire-extinguishing system operating with IG-541*

In addition to the requirements of 9.3.1.40.2.1 to 9.3.1.40.2.9, fire-extinguishing systems using IG-541 as an extinguishing agent shall conform to the following provisions:

- (a) Where there are several spaces with different gross volumes, every space shall be equipped with its own fire-extinguishing system;
- (b) Every tank containing IG-541 placed in the space to be protected shall be fitted with a device to prevent overpressure. This device shall ensure that the contents of the tank are safely diffused in the space to be protected if the tank is subjected to fire, when the fire-extinguishing system has not been brought into service;
- (c) Each tank shall be fitted with a device for checking the contents;
- (d) The filling pressure of the tanks shall not exceed 200 bar at a temperature of +15 °C;
- (e) The concentration of IG-541 in the space to be protected shall be not less than 44% and not more than 50% of the gross volume of the space. This quantity shall be released within 120 seconds.

9.3.1.40.2.13 *Fire-extinguishing system operating with FK-5-1-12*

In addition to the requirements of 9.3.1.40.2.1 to 9.3.1.40.2.9, fire-extinguishing systems using FK-5-1-12 as an extinguishing agent shall comply with the following provisions:

- (a) Where there are several spaces with different gross volumes, every space shall be equipped with its own fire-extinguishing system;
- (b) Every tank containing FK-5-1-12 placed in the space to be protected shall be fitted with a device to prevent overpressure. This device shall ensure that the contents of the tank are safely diffused in the space to be protected if the tank is subjected to fire, when the fire-extinguishing system has not been brought into service;
- (c) Every tank shall be fitted with a device permitting control of the gas pressure;
- (d) The level of filling of tanks shall not exceed 1.00 kg/l. The specific volume of depressurized FK-5-1-12 shall be taken to be 0.0719 m³/kg;
- (e) The volume of FK-5-1-12 in the space to be protected shall be not less than 5.5% of the gross volume of the space. This quantity shall be released within 10 seconds;
- (f) Tanks of FK-5-1-12 shall be fitted with a pressure monitoring device which triggers an audible and visual alarm in the wheelhouse in the event of an unscheduled loss of extinguishing agent. Where there is no wheelhouse, the alarm shall be triggered outside the space to be protected;

- (g) After discharge, the concentration in the space to be protected shall not exceed 10.0%.

9.3.1.40.2.14 *Fixed fire-extinguishing system for physical protection*

In order to ensure physical protection in the engine rooms, boiler rooms and pump rooms, permanently fixed fire-extinguishing systems are accepted solely on the basis of recommendations by the Administrative Committee.

9.3.1.40.3 The two hand fire-extinguishers referred to in 8.1.4 shall be located in the cargo area.

9.3.1.40.4 The fire-extinguishing agent and the quantity contained in the permanently fixed fire-extinguishing system shall be suitable and sufficient for fighting fires.

9.3.1.41 *Fire and naked light*

9.3.1.41.1 The outlets of funnels shall be located not less than 2.00 m from the cargo area. Arrangements shall be provided to prevent the escape of sparks and the entry of water.

9.3.1.41.2 Heating, cooking and refrigerating appliances shall not be fuelled with liquid fuels, liquid gas or solid fuels.

The installation in the engine room or in another separate space of heating appliances fuelled with liquid fuel having a flash-point above 55 °C is, however, permitted.

Cooking and refrigerating appliances are permitted only in the accommodation.

9.3.1.41.3 Only electrical lighting appliances are permitted.

9.3.1.42-
9.3.1.49 (*Reserved*)

9.3.1.50 *Documents concerning electrical installations*

9.3.1.50.1 In addition to the documents required by the Regulations referred to in 1.1.4.6, the following documents shall be on board:

(a) a drawing indicating the boundaries of the cargo area and the location of the electrical equipment installed in this area;

(b) a list of the electrical equipment referred to in (a) above including the following particulars:

machine or appliance, location, type of protection, type of protection against explosion, testing body and approval number;

(c) a list of or general plan indicating the electrical equipment outside the cargo area which may be operated during loading, unloading or gas-freeing. All other electrical equipment shall be marked in red. See 9.3.1.52.3 and 9.3.1.52.4.

9.3.1.50.2 The documents listed above shall bear the stamp of the competent authority issuing the certificate of approval.

9.3.1.51 *Electrical installations*

9.3.1.51.1 Only distribution systems without return connection to the hull are permitted.

This provision does not apply to:

- active cathodic corrosion protection;
- local installations outside the cargo area (e.g. connections of starters of diesel engines);
- the device for checking the insulation level referred to in 9.3.1.51.2 below.

9.3.1.51.2 Every insulated distribution network shall be fitted with an automatic device with a visual and audible alarm for checking the insulation level.

9.3.1.51.3 For the selection of electrical equipment to be used in zones presenting an explosion risk, the explosion groups and temperature classes assigned to the substances carried in the list of substances shall be taken into consideration (See columns (15) and (16) of Table C of Chapter 3.2).

9.3.1.52 *Type and location of electrical equipment*

- 9.3.1.52.1 (a) Only the following equipment may be installed in cargo tanks and piping for loading and unloading (comparable to zone 0):
- measuring, regulation and alarm devices of the EEx (ia) type of protection.
- (b) Only the following equipment may be installed in the cofferdams, double-hull spaces, double bottoms and hold spaces (comparable to zone 1):
- measuring, regulation and alarm devices of the certified safe type;
 - lighting appliances of the “flame-proof enclosure” or “apparatus protected by pressurization” type of protection;
 - hermetically sealed echo sounding devices the cables of which are led through thick-walled steel tubes with gastight connections up to the main deck;
 - cables for the active cathodic protection of the shell plating in protective steel tubes such as those provided for echo sounding devices.
- (c) Only the following equipment may be installed in the service spaces in the cargo area below deck (comparable to zone 1):
- measuring, regulation and alarm devices of the certified safe type;
 - lighting appliances of the “flame-proof enclosure” or “apparatus protected by pressurization” type of protection;
 - motors driving essential equipment such as ballast pumps; they shall be of the certified safe type.
- (d) The control and protective equipment of the electrical equipment referred to in (a), (b) and (c) above shall be located outside the cargo area if they are not intrinsically safe.
- (e) The electrical equipment in the cargo area on deck (comparable to zone 1) shall be of the certified safe type.

- 9.3.1.52.2 Accumulators shall be located outside the cargo area.
- 9.3.1.52.3 (a) Electrical equipment used during loading, unloading and gas-freeing during berthing and which are located outside the cargo area (comparable to zone 2) shall be at least of the “limited explosion risk” type.
- (b) This provision does not apply to:
- (i) lighting installations in the accommodation, except for switches near entrances to accommodation;
 - (ii) radiotelephone installations in the accommodation or the wheelhouse;
 - (iii) mobile and fixed telephone installations in the accommodation or the wheelhouse;
 - (iv) electrical installations in the accommodation, the wheelhouse or the service spaces outside the cargo areas if:
 1. These spaces are fitted with a ventilation system ensuring an overpressure of 0.1 kPa (0.001 bar) and none of the windows is capable of being opened; the air intakes of the ventilation system located as far away as possible, however, not less than 6.00 m from the cargo area and not less than 2.00 m above the deck;
 2. The spaces are fitted with a gas detection system with sensors:
 - at the suction inlets of the ventilation system;
 - directly at the top edge of the sill of the entrance doors of the accommodation and service spaces;
 3. The gas concentration measurement is continuous;
 4. When the gas concentration reaches 20% of the lower explosive limit, the ventilators shall be switched off. In such a case and when the overpressure is not maintained or in the event of failure of the gas detection system, the electrical installations which do not comply with (a) above, shall be switched off. These operations shall be performed immediately and automatically and activate the emergency lighting in the accommodation, the wheelhouse and the service spaces, which shall comply at least with the “limited explosion risk” type. The switching-off shall be indicated in the accommodation and wheelhouse by visual and audible signals;
 5. The ventilation system, the gas detection system and the alarm of the switch-off device fully comply with the requirements of (a) above;
 6. The automatic switch-off device is set so that no automatic switching-off may occur while the vessel is under way.
- 9.3.1.52.4 The electrical equipment which does not meet the requirements set out in 9.3.1.52.3 above together with its switches shall be marked in red. The disconnection of such equipment shall be operated from a centralised location on board.

- 9.3.1.52.5 An electric generator which is permanently driven by an engine and which does not meet the requirements of 9.3.1.52.3 above, shall be fitted with a switch capable of shutting down the excitation of the generator. A notice board with the operating instructions shall be displayed near the switch.
- 9.3.1.52.6 Sockets for the connection of signal lights and gangway lighting shall be permanently fitted to the vessel close to the signal mast or the gangway. Connecting and disconnecting shall not be possible except when the sockets are not live.
- 9.3.1.52.7 The failure of the power supply for the safety and control equipment shall be immediately indicated by visual and audible signals at the locations where the alarms are usually actuated.

9.3.1.53 *Earthing*

- 9.3.1.53.1 The metal parts of electrical appliances in the cargo area which are not live as well as protective metal tubes or metal sheaths of cables in normal service shall be earthed, unless they are so arranged that they are automatically earthed by bonding to the metal structure of the vessel.
- 9.3.1.53.2 The provisions of 9.3.1.53.1 above apply also to equipment having service voltages of less than 50 V.
- 9.3.1.53.3 Independent cargo tanks shall be earthed.
- 9.3.1.53.4 Receptacles for residual products shall be capable of being earthed.
- 9.3.1.54-
9.3.1.55 (*Reserved*)

9.3.1.56 *Electrical cables*

- 9.3.1.56.1 All cables in the cargo area shall have a metallic sheath.
- 9.3.1.56.2 Cables and sockets in the cargo area shall be protected against mechanical damage.
- 9.3.1.56.3 Movable cables are prohibited in the cargo area, except for intrinsically safe electric circuits or for the supply of signal lights and gangway lighting.
- 9.3.1.56.4 Cables of intrinsically safe circuits shall only be used for such circuits and shall be separated from other cables not intended for being used in such circuits (e.g. they shall not be installed together in the same string of cables and they shall not be fixed by the same cable clamps).
- 9.3.1.56.5 For movable cables intended for signal lights and gangway lighting, only sheathed cables of type H 07 RN-F in accordance with standard IEC 60 245-4:1994 or cables of at least equivalent design having conductors with a cross-section of not less than 1.5 mm² shall be used.
- These cables shall be as short as possible and installed so that damage is not likely to occur.
- 9.3.1.56.6 The cables required for the electrical equipment referred to in 9.3.1.52.1 (b) and (c) are accepted in cofferdams, double-hull spaces, double bottoms, hold spaces and service spaces below deck.
- 9.3.1.57-
9.3.1.59 (*Reserved*)

9.3.1.60 *Special equipment*

A shower and an eye and face bath shall be provided on the vessel at a location which is directly accessible from the cargo area.

9.3.1.61-
9.3.1.70 (*Reserved*)

9.3.1.71 *Admittance on board*

The notice boards displaying the prohibition of admittance in accordance with 8.3.3 shall be clearly legible from either side of the vessel.

9.3.1.72-
9.3.1.73 (*Reserved*)

9.3.1.74 *Prohibition of smoking, fire or naked light*

9.3.1.74.1 The notice boards displaying the prohibition of smoking in accordance with 8.3.4 shall be clearly legible from either side of the vessel.

9.3.1.74.2 Notice boards indicating the circumstances under which the prohibition is applicable shall be fitted near the entrances to the spaces where smoking or the use of fire or naked light is not always prohibited.

9.3.1.74.3 Ashtrays shall be provided close to each exit of the accommodation and the wheelhouse.

9.3.1.75-
9.3.1.91 (*Reserved*)

9.3.1.92 *Emergency exit*

Spaces the entrances or exits of which are likely to become partly or completely immersed in the damaged condition shall have an emergency exit which is situated not less than 0.10 m above the damage waterline. This does not apply to forepeak and afterpeak.

9.3.1.93-
9.3.1.99 (*Reserved*)

9.3.2 Rules for construction of type C tank vessels

The rules for construction of 9.3.2.0 to 9.3.2.99 apply to type C tank vessels.

9.3.2.0 *Materials of construction*

- 9.3.2.0.1 (a) The vessel's hull and the cargo tanks shall be constructed of shipbuilding steel or other at least equivalent metal.

The independent cargo tanks may also be constructed of other materials, provided these have at least equivalent mechanical properties and resistance against the effects of temperature and fire.

- (b) Every part of the vessel including any installation and equipment which may come into contact with the cargo shall consist of materials which can neither be dangerously affected by the cargo nor cause decomposition of the cargo or react with it so as to form harmful or hazardous products. In case it has not been possible to examine this during classification and inspection of the vessel a relevant reservation shall be entered in the vessel substance list according to 1.16.1.2.5.

- (c) Vapour pipes and gas discharge pipes shall be protected against corrosion.

- 9.3.2.0.2 Except where explicitly permitted in 9.3.2.0.3 below or in the certificate of approval, the use of wood, aluminium alloys or plastic materials within the cargo area is prohibited.

- 9.3.2.0.3 (a) The use of wood, aluminium alloys or plastic materials within the cargo area is only permitted for:

- gangways and external ladders;
- movable items of equipment (aluminium gauging rods are, however permitted, provided that they are fitted with brass feet or protected in another way to avoid sparking);
- chocking of cargo tanks which are independent of the vessel's hull and chocking of installations and equipment;
- masts and similar round timber;
- engine parts;
- parts of the electrical installation;
- loading and unloading appliances;
- lids of boxes which are placed on the deck.

- (b) The use of wood or plastic materials within the cargo area is only permitted for:

- supports and stops of any kind.

- (c) The use of plastic materials or rubber within the cargo area is only permitted for:

- coating of cargo tanks and of piping for loading and unloading;
- all kinds of gaskets (e.g. for dome or hatch covers);

- electric cables;
- hose assemblies for loading and unloading;
- insulation of cargo tanks and of piping for loading and unloading;
- photo-optical copies of the certificate of approval according to 8.1.2.6 or 8.1.2.7.

(d) All permanently fitted materials in the accommodation or wheelhouse, with the exception of furniture, shall not readily ignite. They shall not evolve fumes or toxic gases in dangerous quantities, if involved in a fire.

9.3.2.0.4 The paint used in the cargo area shall not be liable to produce sparks in case of impact.

9.3.2.0.5 The use of plastic material for vessel's boats is permitted only if the material does not readily ignite.

9.3.2.1-
9.3.2.7 (*Reserved*)

9.3.2.8 Classification

9.3.2.8.1 The tank vessel shall be built under survey of a recognised classification society in accordance with the rules established by that classification society for its highest class, and the tank vessel shall be classed accordingly.

The vessel's highest class shall be continued.

The classification society shall issue a certificate certifying that the vessel is in conformity with the rules of this section (classification certificate).

The design pressure and the test pressure of cargo tanks shall be entered in the certificate.

If a vessel has cargo tanks with different valve opening pressures, the design and test pressures of each tank shall be entered in the certificate.

The classification society shall draw up a vessel substance list mentioning all the dangerous goods accepted for carriage by the tank vessel (see also 1.16.1.2.5).

9.3.2.8.2 The cargo pump-rooms shall be inspected by a recognised classification society whenever the certificate of approval has to be renewed as well as during the third year of validity of the certificate of approval. The inspection shall comprise at least:

- an inspection of the whole system for its condition, for corrosion, leakage or conversion works which have not been approved;
- a checking of the condition of the gas detection system in the cargo pump-rooms.

Inspection certificates signed by the recognised classification society with respect to the inspection of the cargo pump-rooms shall be kept on board. The inspection certificates shall at least include particulars of the above inspection and the results obtained as well as the date of the inspection.

9.3.2.8.3 The condition of the gas detection system referred to in 9.3.2.52.3 shall be checked by a recognised classification society whenever the certificate of approval has to be renewed and during the third year of validity of the certificate of approval. A certificate signed by the recognised classification society shall be kept on board.

9.3.2.9 *(Reserved)*

9.3.2.10 *Protection against the penetration of gases*

9.3.2.10.1 The vessel shall be designed so as to prevent gases from penetrating into the accommodation and the service spaces.

9.3.2.10.2 Outside the cargo area, the lower edges of door-openings in the sidewalls of superstructures and the coamings of access hatches to under-deck spaces shall have a height of not less than 0.50 m above the deck.

This requirement need not be complied with if the wall of the superstructures facing the cargo area extends from one side of the ship to the other and has doors the sills of which have a height of not less than 0.50 m. The height of this wall shall be not less than 2.00 m. In this case, the lower edges of door-openings in the sidewalls of superstructures and of coamings of access hatches behind this wall shall have a height of not less than 0.10 m. The sills of engine-room doors and the coamings of its access hatches shall, however, always have a height of not less than 0.50 m.

9.3.2.10.3 In the cargo area, the lower edges of door-openings in the sidewalls of superstructures shall have a height of not less than 0.50 m above the deck and the sills of hatches and ventilation openings of premises located under the deck shall have a height of not less than 0.50 m above the deck. This requirement does not apply to access openings to double-hull and double bottom spaces.

9.3.2.10.4 The bulwarks, foot-rails, etc. shall be provided with sufficiently large openings which are located directly above the deck.

9.3.2.11 *Hold spaces and cargo tanks*

9.3.2.11.1 (a) The maximum permissible capacity of a cargo tank shall be determined in accordance with the following table:

$L \times B \times H$ (m ³)	Maximum permissible capacity of a cargo tank (m ³)
up to 600	$L \times B \times H \times 0.3$
600 to 3 750	$180 + (L \times B \times H - 600) \times 0.0635$
> 3 750	380

Alternative constructions in accordance with 9.3.4 are permitted.

In the table above $L \times B \times H$ is the product of the main dimensions of the tank vessel in metres (according to the measurement certificate), where:

- L = overall length of the hull in m;
- B = extreme breadth of the hull in m;
- H = shortest vertical distance in m between the top of the keel and the lowest point of the deck at the side of the vessel (moulded depth) within the cargo area.

- (b) The relative density of the substances to be carried shall be taken into consideration in the design of the cargo tanks. The maximum relative density shall be indicated in the certificate of approval.
- (c) When the vessel is provided with pressure cargo tanks, these tanks shall be designed for a working pressure of 400 kPa (4 bar).
- (d) For vessels with a length of not more than 50.00 m, the length of a cargo tank shall not exceed 10.00 m; and

For vessels with a length of more than 50.00 m, the length of a cargo tank shall not exceed 0.20 l.

This provision does not apply to vessels with independent built-in cylindrical tanks having a length to diameter ratio ≤ 7 .

9.3.2.11.2

- (a) In the cargo area (except cofferdams) the vessel shall be designed as a flush-deck double-hull vessel, with double-hull spaces and double bottoms, but without a trunk.

Cargo tanks independent of the vessel's hull and refrigerated cargo tanks may only be installed in a hold space which is bounded by double-hull spaces and double bottoms in accordance with 9.3.2.11.7 below. The cargo tanks shall not extend beyond the deck.

- (b) The cargo tanks independent of the vessel's hull shall be fixed so that they cannot float.
- (c) The capacity of a suction well shall be limited to not more than 0.10 m³.
- (d) Side-struts linking or supporting the load-bearing components of the sides of the vessel with the load-bearing components of the longitudinal walls of cargo tanks and side-struts linking the load-bearing components of the vessel's bottom with the tank-bottom are prohibited.
- (e) A local recess in the cargo deck, contained on all sides, with a depth greater than 0.1 m, designed to house the loading and unloading pump, is permitted if it fulfils the following conditions:
 - The recess shall not be greater than 1 m in depth.
 - The recess shall be located not less than 6 m from entrances and openings to accommodation and service spaces outside the cargo area.
 - The recess shall be located at a minimum distance from the side plating equal to one quarter of the vessel's breadth.
 - All pipes linking the recess to the cargo tanks shall be fitted with shut-off devices fitted directly on the bulkhead.
 - All the controls required for the equipment located in the recess shall be activated from the deck.
 - If the recess is deeper than 0.5 m, it shall be provided with a permanent gas detection system which automatically indicates the presence of explosive gases by means of direct-measuring sensors and actuates a visual and audible alarm when the gas concentration has reached 20% of the lower explosion limit. The sensors of this

system shall be placed at suitable positions at the bottom of the recess. Measurement shall be continuous.

- Visual and audible alarms shall be installed in the wheelhouse and on deck and, when the alarm is actuated, the vessel loading and unloading system shall be shut down. Failure of the gas detection system shall be immediately signalled in the wheelhouse and on deck by means of visual and audible alarms.
- It shall be possible to drain the recess using a system installed on deck in the cargo area and independent of any other system.
- The recess shall be provided with a level alarm device which activates the draining system and triggers a visual and audible alarm in the wheelhouse when liquid accumulates at the bottom.
- When the recess is located above the cofferdam, the engine room bulkhead shall have an ‘A-60’ fire protection insulation according to SOLAS 74, Chapter II-2, Regulation 3.
- When the cargo area is fitted with a water-spray system, electrical equipment located in the recess shall be protected against infiltration of water.
- Pipes connecting the recess to the hull shall not pass through the cargo tanks.

- 9.3.2.11.3
- (a) The cargo tanks shall be separated by cofferdams of at least 0.60 m in width from the accommodation, engine room and service spaces outside the cargo area below deck or, if there are no such accommodation, engine room and service spaces, from the vessel’s ends. Where the cargo tanks are installed in a hold space, a space of not less than 0.50 m shall be provided between such tanks and the end bulkheads of the hold space. In this case an end bulkhead meeting at least the definition for Class “A-60” according to SOLAS 74, Chapter II-2, Regulation 3, shall be deemed equivalent to a cofferdam. For pressure cargo tanks, the 0.50 m distance may be reduced to 0.20 m.
 - (b) Hold spaces, cofferdams and cargo tanks shall be capable of being inspected.
 - (c) All spaces in the cargo area shall be capable of being ventilated. Means for checking their gas-free condition shall be provided.

9.3.2.11.4 The bulkheads bounding the cargo tanks, cofferdams and hold spaces shall be watertight. The cargo tanks and the bulkheads bounding the cargo area shall have no openings or penetrations below deck.

The bulkhead between the engine room and the cofferdam or service space in the cargo area or between the engine room and a hold space may be fitted with penetrations provided that they conform to the provisions of 9.3.2.17.5.

The bulkhead between the cargo tank and the cargo pump-room below deck may be fitted with penetrations provided that they conform to the provisions of 9.3.2.17.6. The bulkheads between the cargo tanks may be fitted with penetrations provided that the loading or unloading piping are fitted with shut-off devices in the cargo tank from which they come. These shut-off devices shall be operable from the deck.

9.3.2.11.5 Double-hull spaces and double bottoms in the cargo area shall be arranged for being filled with ballast water only. Double bottoms may, however, be used as oil fuel tanks, provided they comply with the provisions of 9.3.2.32.

- 9.3.2.11.6
- (a) A cofferdam, the centre part of a cofferdam or another space below deck in the cargo area may be arranged as a service space, provided the bulkheads bounding the service space extend vertically to the bottom. This service space shall only be accessible from the deck.
 - (b) The service space shall be watertight with the exception of its access hatches and ventilation inlets.
 - (c) No piping for loading and unloading shall be fitted within the service space referred to under (a) above.

Piping for loading and unloading may be fitted in the cargo pump-rooms below deck only when they conform to the provisions of 9.3.2.17.6.

9.3.2.11.7 For double-hull construction with the cargo tanks integrated in the vessel's structure, the distance between the side wall of the vessel and the longitudinal bulkhead of the cargo tanks shall be not less than 1.00 m. A distance of 0.80 m may however be permitted, provided that, compared with the scantling requirements specified in the rules for construction of a recognised classification society, the following reinforcements have been made:

- (a) 25% increase in the thickness of the deck stringer plate;
- (b) 15% increase in the side plating thickness;
- (c) Arrangement of a longitudinal framing system at the vessel's side, where depth of the longitudinals shall be not less than 0.15 m and the longitudinals shall have a face plate with the cross-sectional area of at least 7.0 cm².
- (d) The stringer or longitudinal framing systems shall be supported by web frames, and like bottom girders fitted with lightening holes, at a maximum spacing of 1.80 m. These distances may be increased if the longitudinals are strengthened accordingly.

When a vessel is built according to the transverse framing system, a longitudinal stringer system shall be arranged instead of (c) above. The distance between the longitudinal stringers shall not exceed 0.80 m and their depth shall be not less than 0.15 m, provided they are completely welded to the frames. The cross-sectional area of the facebar or faceplate shall be not less than 7.0 cm² as in (c) above. Where cut-outs are arranged in the stringer at the connection with the frames, the web depth of the stringer shall be increased with the depth of cut-outs.

The mean depth of the double bottoms shall be not less than 0.70 m. It shall, however, never be less than 0.60 m.

The depth below the suction wells may be reduced to 0.50 m.

Alternative constructions in accordance with 9.3.4 are permitted.

9.3.2.11.8 When a vessel is built with cargo tanks located in a hold space or refrigerated cargo tanks, the distance between the double walls of the hold space shall be not less than 0.80 m and the depth of the double bottom shall be not less than 0.60 m.

9.3.2.11.9 Where service spaces are located in the cargo area under deck, they shall be arranged so as to be easily accessible and to permit persons wearing protective clothing and breathing apparatus to safely operate the service equipment contained therein. They shall be designed so as to allow injured or unconscious personnel to be removed from such spaces without difficulties, if necessary by means of fixed equipment.

- 9.3.2.11.10 Cofferdams, double-hull spaces, double bottoms, cargo tanks, hold spaces and other accessible spaces within the cargo area shall be arranged so that they may be completely inspected and cleaned in an appropriate manner. The dimensions of openings except for those of double-hull spaces and double bottoms which do not have a wall adjoining the cargo tanks shall be sufficient to allow a person wearing breathing apparatus to enter or leave the space without difficulties. These openings shall have a minimum cross-sectional area of 0.36 m² and a minimum side length of 0.50 m. They shall be designed so as to allow an injured or unconscious person to be removed from the bottom of such a space without difficulties, if necessary by means of fixed equipment. In these spaces the distance between the reinforcements shall not be less than 0.50 m. In double bottoms this distance may be reduced to 0.45 m.

Cargo tanks may have circular openings with a diameter of not less than 0.68 m.

9.3.2.12 *Ventilation*

- 9.3.2.12.1 Each hold space shall have two openings the dimensions and location of which shall be such as to permit effective ventilation of any part of the hold space. If there are no such openings, it shall be possible to fill the hold spaces with inert gas or dry air.
- 9.3.2.12.2 Double-hull spaces and double bottoms within the cargo area which are not arranged for being filled with ballast water, hold spaces and cofferdams shall be provided with ventilation systems.
- 9.3.2.12.3 Any service spaces located in the cargo area below deck shall be provided with a system of forced ventilation with sufficient power for ensuring at least 20 changes of air per hour based on the volume of the space.

The ventilation exhaust ducts shall extend down to 50 mm above the bottom of the service space. The air shall be supplied through a duct at the top of the service space. The air inlets shall be located not less than 2.00 m above the deck, at a distance of not less than 2.00 m from tank openings and 6.00 m from the outlets of safety valves.

The extension pipes, which may be necessary, may be of the hinged type.

- 9.3.2.12.4 Ventilation of accommodation and service spaces shall be possible.
- 9.3.2.12.5 Ventilators used in the cargo area shall be designed so that no sparks may be emitted on contact of the impeller blades with the housing and no static electricity may be generated.
- 9.3.2.12.6 Notice boards shall be fitted at the ventilation inlets indicating the conditions when they shall be closed. Any ventilation inlets of accommodation and service spaces leading outside shall be fitted with fire flaps. Such ventilation inlets shall be located not less than 2.00 m from the cargo area.

Ventilation inlets of service spaces in the cargo area may be located within such area.

- 9.3.2.12.7 The flame-arresters prescribed in 9.3.2.20.4, 9.3.2.22.4, 9.3.2.22.5 and 9.3.2.26.4 shall be of a type approved for this purpose by the competent authority.

9.3.2.13 *Stability (general)*

- 9.3.2.13.1 Proof of sufficient stability shall be furnished including for stability in damaged condition.

9.3.2.13.2 The basic values for the stability calculation - the vessel's lightweight and location of the centre of gravity - shall be determined either by means of an inclining experiment or by detailed mass and moment calculation. In the latter case the lightweight of the vessel shall be checked by means of a lightweight test with a tolerance limit of $\pm 5\%$ between the mass determined by calculation and the displacement determined by the draught readings.

9.3.2.13.3 Proof of sufficient intact stability shall be furnished for all stages of loading and unloading and for the final loading condition for all the relative densities of the substances transported contained in the vessel substance list according to 1.16.1.2.5.

For every loading operation, taking account of the actual fillings and floating position of cargo tanks, ballast tanks and compartments, drinking water and sewage tanks and tanks containing products for the operation of the vessel, the vessel shall comply with the intact and damage stability requirements.

Intermediate stages during operations shall also be taken into consideration.

The proof of sufficient stability shall be shown for every operating, loading and ballast condition in the stability booklet, to be approved by the relevant classification society, which classes the vessel. If it is unpractical to pre-calculate the operating, loading and ballast conditions, a loading instrument approved by the recognised classification society which classes the vessel shall be installed and used which contains the contents of the stability booklet.

NOTE: A stability booklet shall be worded in a form comprehensible for the responsible master and containing the following details:

General description of the vessel:

- *General arrangement and capacity plans indicating the assigned use of compartments and spaces (cargo tanks, stores, accommodation, etc.);*
- *A sketch indicating the position of the draught marks referring to the vessel's perpendiculars;*
- *A scheme for ballast/bilge pumping and overflow prevention systems;*
- *Hydrostatic curves or tables corresponding to the design trim, and, if significant trim angles are foreseen during the normal operation of the vessel, curves or tables corresponding to such range of trim are to be introduced;*
- *Cross curves or tables of stability calculated on a free trimming basis, for the ranges of displacement and trim anticipated in normal operating conditions, with an indication of the volumes which have been considered buoyant;*
- *Tank sounding tables or curves showing capacities, centres of gravity, and free surface data for all cargo tanks, ballast tanks and compartments, drinking water and sewage water tanks and tanks containing products for the operation of the vessel;*
- *Lightship data (weight and centre of gravity) resulting from an inclining test or deadweight measurement in combination with a detailed mass balance or other acceptable measures. Where the above-mentioned information is derived from a sister vessel, the reference to this sister vessel shall be clearly indicated, and a copy of the approved inclining test report relevant to this sister vessel shall be included;*

- *A copy of the approved test report shall be included in the stability booklet;*
- *Operating loading conditions with all relevant details, such as:*
 - *Lightship data, tank fillings, stores, crew and other relevant items on board (mass and centre of gravity for each item, free surface moments for liquid loads);*
 - *Draughts amidships and at perpendiculars;*
 - *Metacentric height corrected for free surfaces effect;*
 - *Righting lever values and curve;*
 - *Longitudinal bending moments and shear forces at read-out points;*
 - *Information about openings (location, type of tightness, means of closure); and*
 - *Information for the master;*
- *Calculation of the influence of ballast water on stability with information on whether fixed level gauges for ballast tanks and compartments have to be installed or whether the ballast tanks or compartments shall be completely full or completely empty when underway.*

9.3.2.14 *Stability (intact)*

9.3.2.14.1 The requirements for intact stability resulting from the damage stability calculation shall be fully complied with.

9.3.2.14.2 For vessels with cargo tanks of more than 0.70 B in width, proof shall be furnished that the following stability requirements have been complied with:

- (a) In the positive area of the righting lever curve up to immersion of the first non-watertight opening there shall be a righting lever (GZ) of not less than 0.10 m;
- (b) The surface of the positive area of the righting lever curve up to immersion of the first non-watertight opening and in any event up to an angle of heel $\leq 27^\circ$ shall not be less than 0.024 m.rad;
- (c) The metacentric height (GM) shall be not less than 0.10 m.

These conditions shall be met bearing in mind the influence of all free surfaces in tanks for all stages of loading and unloading.

9.3.2.14.3 The most stringent requirement of 9.3.2.14.1 and 9.3.2.14.2 is applicable to the vessel.

9.3.2.15 *Stability (damaged condition)*

9.3.2.15.1 The following assumptions shall be taken into consideration for the damaged condition:

- (a) The extent of side damage is as follows:

longitudinal extent:	at least 0.10 L, but not less than 5.00 m;
transverse extent:	0.79 m, or when applicable, the distance allowed by section 9.3.4, reduced by 0.01 m;
vertical extent:	from the base line upwards without limit.
- (b) The extent of bottom damage is as follows:

longitudinal extent:	at least 0.10 L, but not less than 5.00 m;
transverse extent:	3.00 m;

vertical extent: from the base 0.59 m upwards, the sump excepted.

- (c) Any bulkheads within the damaged area shall be assumed damaged, which means that the location of bulkheads shall be chosen so as to ensure that the vessel remains afloat after the flooding of two or more adjacent compartments in the longitudinal direction.

The following provisions are applicable:

- For bottom damage, adjacent athwartship compartments shall also be assumed as flooded;
- The lower edge of any non-watertight openings (e.g. doors, windows, access hatchways) shall, at the final stage of flooding, be not less than 0.10 m above the damage waterline;
- In general, permeability shall be assumed to be 95%. Where an average permeability of less than 95% is calculated for any compartment, this calculated value obtained may be used.

However, the following minimum values shall be used:

- engine rooms: 85%;
- accommodation: 95%;
- double bottoms, oil fuel tanks, ballast tanks, etc., depending on whether, according to their function, they have to be assumed as full or empty for the vessel floating at the maximum permissible draught: 0% or 95%.

For the main engine room only the one-compartment standard need be taken into account, i.e. the end bulkheads of the engine room shall be assumed as not damaged.

- 9.3.2.15.2 At the stage of equilibrium (final stage of flooding), the angle of heel shall not exceed 12°. Non-watertight openings shall not be flooded before reaching the stage of equilibrium. If such openings are immersed before that stage, the corresponding spaces shall be considered as flooded for the purpose of the stability calculation.

The positive range of the righting lever curve beyond the stage of equilibrium shall have a righting lever of ≥ 0.05 m in association with an area under the curve of ≥ 0.0065 m.rad. The minimum values of stability shall be satisfied up to immersion of the first non-watertight opening and in any event up to an angle of heel $\leq 27^\circ$. If non-watertight openings are immersed before that stage, the corresponding spaces shall be considered as flooded for the purposes of stability calculation.

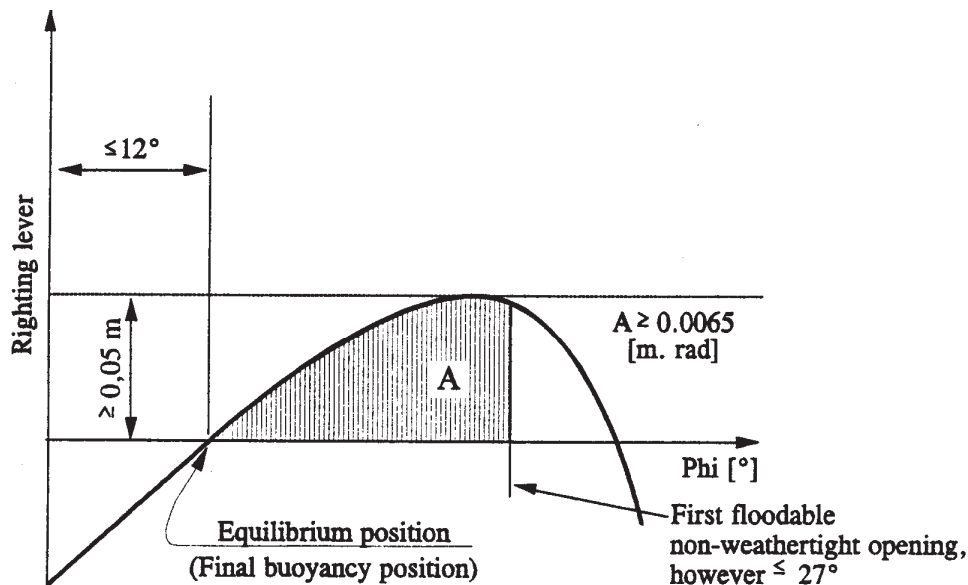

9.3.2.15.3 If openings through which undamaged compartments may additionally become flooded are capable of being closed watertight, the closing appliances shall be marked accordingly.

9.3.2.15.4 Where cross- or down-flooding openings are provided for reduction of unsymmetrical flooding, the time for equalisation shall not exceed 15 minutes, if during the intermediate stages of flooding sufficient stability has been proved.

9.3.2.16 *Engine rooms*

9.3.2.16.1 Internal combustion engines for the vessel's propulsion as well as internal combustion engines for auxiliary machinery shall be located outside the cargo area. Entrances and other openings of engine rooms shall be at a distance of not less than 2.00 m from the cargo area.

9.3.2.16.2 The engine rooms shall be accessible from the deck; the entrances shall not face the cargo area. Where the doors are not located in a recess whose depth is at least equal to the door width, the hinges shall face the cargo area.

9.3.2.17 *Accommodation and service spaces*

9.3.2.17.1 Accommodation spaces and the wheelhouse shall be located outside the cargo area forward of the fore vertical plane or abaft the aft vertical plane bounding the part of the cargo area below deck. Windows of the wheelhouse which are located not less than 1.00 m above the bottom of the wheelhouse may tilt forward.

9.3.2.17.2 Entrances to spaces and openings of superstructures shall not face the cargo area. Doors opening outward and not located in a recess the depth of which is at least equal to the width of the doors shall have their hinges face the cargo area.

9.3.2.17.3 Entrances from the deck and openings of spaces facing the weather shall be capable of being closed. The following instruction shall be displayed at the entrance of such spaces:

**Do not open during loading and unloading without
the permission of the master.
Close immediately.**

- 9.3.2.17.4 Entrances and windows of superstructures and accommodation spaces which can be opened as well as other openings of these spaces shall be located not less than 2.00 m from the cargo area. No wheelhouse doors and windows shall be located within 2.00 m from the cargo area, except where there is no direct connection between the wheelhouse and the accommodation.
- 9.3.2.17.5
- (a) Driving shafts of the bilge or ballast pumps in the cargo area may penetrate through the bulkhead between the service space and the engine room, provided the arrangement of the service space is in compliance with 9.3.2.11.6.
 - (b) The penetration of the shaft through the bulkhead shall be gastight and shall have been approved by a recognised classification society.
 - (c) The necessary operating instructions shall be displayed.
 - (d) Penetrations through the bulkhead between the engine room and the service space in the cargo area and the bulkhead between the engine room and the hold spaces may be provided for electrical cables, hydraulic and piping for measuring, control and alarm systems, provided that the penetration have been approved by a recognised classification society. The penetrations shall be gastight. Penetrations through a bulkhead with an “A-60” fire protection insulation according to SOLAS 74, Chapter II-2, Regulation 3, shall have an equivalent fire protection.
 - (e) Pipes may penetrate the bulkhead between the engine room and the service space in the cargo area provided that these are pipes between the mechanical equipment in the engine room and the service space which do not have any openings within the service space and which are provided with shut-off devices at the bulkhead in the engine room.
 - (f) Notwithstanding 9.3.2.11.4, pipes from the engine room may pass through the service space in the cargo area or a cofferdam or a hold space or a double-hull space to the outside provided that within the service space or cofferdam or hold space or double-hull space they are of the thick-walled type and have no flanges or openings.
 - (g) Where a driving shaft of auxiliary machinery penetrates through a wall located above the deck the penetration shall be gastight.
- 9.3.2.17.6 A service space located within the cargo area below deck shall not be used as a cargo pump-room for the loading and unloading system, except where:
- the pump room is separated from the engine room or from service spaces outside the cargo area by a cofferdam or a bulkhead with an “A-60” fire protection insulation according to SOLAS 74, Chapter II-2, Regulation 3, or by a service space or a hold space;
 - the “A-60” bulkhead required above does not include penetrations referred to in 9.3.2.17.5 (a);
 - ventilation exhaust outlets are located not less than 6.00 m from entrances and openings of the accommodation and service spaces outside the cargo area;
 - the access hatches and ventilation inlets can be closed from the outside;
 - all piping for loading and unloading as well as those of stripping systems are provided with shut-off devices at the pump suction side in the cargo pump-room immediately at the bulkhead. The necessary operation of the control devices in the pump-room,

starting of pumps and necessary control of the liquid flow rate shall be effected from the deck;

- the bilge of the cargo pump-room is equipped with a gauging device for measuring the filling level which activates a visual and audible alarm in the wheelhouse when liquid is accumulating in the cargo pump-room bilge;
- the cargo pump-room is provided with a permanent gas-detection system which automatically indicates the presence of explosive gases or lack of oxygen by means of direct-measuring sensors and which actuates a visual and audible alarm when the gas concentration has reached 20% of the lower explosive limit. The sensors of this system shall be placed at suitable positions at the bottom and directly below the deck.

Measurement shall be continuous.

The audible and visual alarms are installed in the wheelhouse and in the cargo pump-room and, when the alarm is actuated, the loading and unloading system is shut down. Failure of the gas detection system shall be immediately signalled in the wheelhouse and on deck by means of audible and visual alarms;

- the ventilation system prescribed in 9.3.2.12.3 has a capacity of not less than 30 changes of air per hour based on the total volume of the service space.

9.3.2.17.7 The following instruction shall be displayed at the entrance of the cargo pump-room:

**Before entering the cargo pump-room check whether
it is free from gases and contains sufficient oxygen.
Do not open doors and entrance openings without
the permission of the master.
Leave immediately in the event of alarm.**

9.3.2.18 *Inerting facility*

In cases in which inerting or blanketing of the cargo is prescribed, the vessel shall be equipped with an inerting system.

This system shall be capable of maintaining a permanent minimum pressure of 7 kPa (0.07 bar) in the spaces to be inerted. In addition, the inerting system shall not increase the pressure in the cargo tank to a pressure greater than that at which the pressure valve is regulated. The set pressure of the vacuum-relief valve shall be 3.5 kPa (0.035 bar).

A sufficient quantity of inert gas for loading or unloading shall be carried or produced on board if it is not possible to obtain it on shore. In addition, a sufficient quantity of inert gas to offset normal losses occurring during carriage shall be on board.

The premises to be inerted shall be equipped with connections for introducing the inert gas and monitoring systems so as to ensure the correct atmosphere on a permanent basis.

When the pressure or the concentration of inert gas in the gaseous phase falls below a given value, this monitoring system shall activate an audible and visible alarm in the wheelhouse. When the wheelhouse is unoccupied, the alarm shall also be perceptible in a location occupied by a crew member.

9.3.2.19 (*Reserved*)

9.3.2.20 *Arrangement of cofferdams*

9.3.2.20.1 Cofferdams or cofferdam compartments remaining once a service space has been arranged in accordance with 9.3.2.11.6 shall be accessible through an access hatch.

If, however, the cofferdam is connected to a double-hull space, it is sufficient for it to be accessible from that space. In this case an arrangement shall be made for possible monitoring in order to ascertain from the deck whether the cofferdam is empty.

9.3.2.20.2 Cofferdams shall be capable of being filled with water and emptied by means of a pump. Filling shall be effected within 30 minutes. These requirements are not applicable when the bulkhead between the engine room and the cofferdam comprises fire-protection insulation "A-60" in accordance with SOLAS 74, Chapter II-2, Regulation 3, or has been fitted out as a service space. The cofferdams shall not be fitted with inlet valves.

9.3.2.20.3 No fixed pipe shall permit connection between a cofferdam and other piping of the vessel outside the cargo area.

9.3.2.20.4 The ventilation openings of cofferdams shall be fitted with a flame-arrester capable of withstanding a deflagration.

9.3.2.21 *Safety and control installations*

9.3.2.21.1 Cargo tanks shall be provided with the following equipment:

- (a) a mark inside the tank indicating the liquid level of 95%;
- (b) a level gauge;
- (c) a level alarm device which is activated at the latest when a degree of filling of 90% is reached;
- (d) a high level sensor for actuating the facility against overflowing at the latest when a degree of filling of 97.5% is reached;
- (e) an instrument for measuring the pressure of the vapour phase inside the cargo tank;
- (f) an instrument for measuring the temperature of the cargo, if in column (9) of Table C of Chapter 3.2 a heating installation is required, or if a maximum temperature is indicated in column (20) of that list;
- (g) a connection for a sampling device, closed or partially closed, and/or at least one sampling opening as required in column (13) of Table C of Chapter 3.2.

9.3.2.21.2 When the degree of filling in per cent is determined, an error of not more than 0.5% is permitted. It shall be calculated on the basis of the total cargo tank capacity including the expansion trunk.

9.3.2.21.3 The level gauge shall allow readings from the control position of the shut-off devices of the particular cargo tank. The permissible maximum filling level of the cargo tank shall be marked on each level gauge.

Permanent reading of the overpressure and vacuum shall be possible from a location from which loading or unloading operations may be interrupted. The permissible maximum overpressure and vacuum shall be marked on each level gauge.

Readings shall be possible in all weather conditions.

9.3.2.21.4 The level alarm device shall give a visual and audible warning on board when actuated. The level alarm device shall be independent of the level gauge.

9.3.2.21.5 (a) The high level sensor referred to in 9.3.2.21.1 (d) above shall give a visual and audible alarm on board and at the same time actuate an electrical contact which in the form of a binary signal interrupts the electric current loop provided and fed by the shore facility, thus initiating measures at the shore facility against overflowing during loading operations.

The signal shall be transmitted to the shore facility via a watertight two-pin plug of a connector device in accordance with standard EN 60309-2:1999 for direct current of 40 to 50 volts, identification colour white, position of the nose 10 h.

The plug shall be permanently fitted to the vessel close to the shore connections of the loading and unloading piping.

The high level sensor shall also be capable of switching off the vessel's own discharging pump. The high level sensor shall be independent of the level alarm device, but it may be connected to the level gauge.

(b) During discharging by means of the on-board pump, it shall be possible for the shore facility to switch it off. For this purpose, an independent intrinsically safe power line, fed by the vessel, shall be switched off by the shore facility by means of an electrical contact.

It shall be possible for the binary signal of the shore facility to be transmitted via a watertight two-pole socket or a connector device in accordance with standard EN 60309-2:1999, for direct current of 40 to 50 volts, identification colour white, position of the nose 10 h.

This socket shall be permanently fitted to the vessel close to the shore connections of the unloading piping.

(c) Vessels which may be delivering products required for operation of vessels shall be equipped with a transshipment facility compatible with European standard EN 12 827:1996 and a rapid closing device enabling refuelling to be interrupted. It shall be possible to actuate this rapid closing device by means of an electrical signal from the overflow prevention system. The electrical circuits actuating the rapid closing device shall be secured according to the quiescent current principle or other appropriate error detection measures. The state of operation of electrical circuits which cannot be controlled using the quiescent current principle shall be capable of being easily checked.

It shall be possible to actuate the rapid closing device independently of the electrical signal.

The rapid closing device shall actuate a visual and audible alarm on board.

9.3.2.21.6 The visual and audible signals given by the level alarm device shall be clearly distinguishable from those of the high level sensor.

The visual alarm shall be visible at each control position on deck of the cargo tank stop valves. It shall be possible to easily check the functioning of the sensors and electric circuits or these shall be "intrinsically safe apparatus".

9.3.2.21.7 When the pressure or temperature exceeds a set value, instruments for measuring the vacuum or overpressure of the gaseous phase in the cargo tank or the temperature of the cargo, shall activate a visual and audible alarm in the wheelhouse. When the wheelhouse is unoccupied the alarm shall also be perceptible in a location occupied by a crew member.

When the pressure exceeds the set value during loading and unloading, the instrument for measuring the pressure shall, by means of the plug referred to in 9.3.2.21.5 above, initiate immediately an electrical contact which shall put into effect measures to interrupt the loading or unloading operation. If the vessel's own discharge pump is used, it shall be switched off automatically.

The instrument for measuring the overpressure or vacuum shall activate the alarm at latest when an overpressure is reached equal to 1.15 times the opening pressure of the pressure relief device, or a vacuum pressure equal to the construction vacuum pressure but not exceeding 5 kPa (0.05 bar). The maximum allowable temperature is indicated in column (20) of Table C of Chapter 3.2. The sensors for the alarms mentioned in this paragraph may be connected to the alarm device of the sensor.

When it is prescribed in column (20) of Table C of Chapter 3.2, the instrument for measuring the overpressure of the gaseous phase shall activate a visible and audible alarm in the wheelhouse when the overpressure exceeds 40 kPa (0.4 bar) during the voyage. When the wheelhouse is unoccupied, the alarm shall also be perceptible in a location occupied by a crew member.

9.3.2.21.8 Where the control elements of the shut-off devices of the cargo tanks are located in a control room, it shall be possible to stop the loading pumps and read the level gauges in the control room, and the visual and audible warning given by the level alarm device, the high level sensor referred to in 9.3.2.21.1 (d) and the instruments for measuring the pressure and temperature of the cargo shall be noticeable in the control room and on deck.

Satisfactory monitoring of the cargo area shall be ensured from the control room.

9.3.2.21.9 The vessel shall be so equipped that loading or unloading operations can be interrupted by means of switches, i.e. the quick-action stop valve located on the flexible vessel-to-shore connecting line must be capable of being closed. The switch shall be placed at two points on the vessel (fore and aft).

This provision applies only when prescribed in column (20) of Table C of Chapter 3.2.

The interruption system shall be designed according to the quiescent current principle.

9.3.2.22 *Cargo tank openings*

9.3.2.22.1 (a) Cargo tank openings shall be located on deck in the cargo area.
(b) Cargo tank openings with a cross-section of more than 0.10 m² and openings of safety devices for preventing overpressures shall be located not less than 0.50 m above deck.

9.3.2.22.2 Cargo tank openings shall be fitted with gastight closures capable of withstanding the test pressure in accordance with 9.3.2.23.2

9.3.2.22.3 Closures which are normally used during loading or unloading operations shall not cause sparking when operated.

9.3.2.22.4 (a) Each cargo tank or group of cargo tanks connected to a common vapour pipe shall be fitted with:

- safety devices for preventing unacceptable overpressures or vacuums. When anti-explosion protection is required in column (17) of Table C of Chapter 3.2, the vacuum valve shall be fitted with a flame arrester capable of withstanding a deflagration and the pressure-relief valve with a high-velocity vent valve capable of withstanding steady burning.

The gases shall be discharged upwards. The opening pressure of the high-velocity vent valve and the opening pressure of the vacuum valve shall be indelibly indicated on the valves;

- a connection for the safe return ashore of gases expelled during loading;
- a device for the safe depressurisation of the tanks consisting of at least a fire-resistant flame-arrester and a stop valve which clearly indicates whether it is open or shut.

- (b) The outlets of high-velocity vent valves shall be located not less than 2.00 m above the deck and at a distance of not less than 6.00 m from the accommodation and from the service spaces outside the cargo area. This height may be reduced when within a radius of 1.00 m round the outlet of the high-velocity vent valve, there is no equipment, no work is being carried out and signs indicate the area. The setting of the high-velocity vent valves shall be such that during the transport operation they do not blow off until the maximum permissible working pressure of the cargo tanks is reached.

9.3.2.22.5

- (a) Insofar as anti-explosion protection is prescribed in column (17) of Table C of Chapter 3.2, a vapour pipe connecting two or more cargo tanks shall be fitted, at the connection to each cargo tank, with a flame arrester with a fixed or spring-loaded plate stack, capable of withstanding a detonation. This equipment may consist of:
- (i) a flame arrester fitted with a fixed plate stack, where each cargo tank is fitted with a vacuum valve capable of withstanding a deflagration and a high-velocity vent valve capable of withstanding steady burning;
 - (ii) a flame arrester fitted with a spring-loaded plate stack, where each cargo tank is fitted with a vacuum valve capable of withstanding a deflagration;
 - (iii) a flame arrester with a fixed plate stack;
 - (iv) a flame arrester with a fixed plate stack, where the pressure-measuring device is fitted with an alarm system in accordance with 9.3.2.21.7;
 - (v) a flame arrester with a spring-loaded plate stack, where the pressure-measuring device is fitted with an alarm system in accordance with 9.3.2.21.7.

When a fire-fighting installation is permanently mounted on deck in the cargo area and can be brought into service from the deck and from the wheelhouse, flame arresters need not be required for individual cargo tanks.

Only substances which do not mix and which do not react dangerously with each other may be carried simultaneously in cargo tanks connected to a common vapour pipe;

or

- (b) Insofar as anti-explosion protection is prescribed in column (17) of Table C of Chapter 3.2, a vapour pipe connecting two or more cargo tanks shall be fitted, at the connection to each cargo tank, with a pressure/vacuum relief valve incorporating a flame arrester capable of withstanding a detonation/deflagration.

Only substances which do not mix and which do not react dangerously with each other may be carried simultaneously in cargo tanks connected to a common vapour pipe;

or

- (c) Insofar as anti-explosion protection is prescribed in column (17) of Table C of Chapter 3.2, an independent vapour pipe for each cargo tank, fitted with a vacuum valve incorporating a flame arrester capable of withstanding a deflagration and a high velocity vent valve incorporating a flame arrester capable of withstanding steady burning. Several different substances may be carried simultaneously;

or

- (d) Insofar as anti-explosion protection is prescribed in column (17) of Table C of Chapter 3.2, a vapour pipe connecting two or more cargo tanks shall be fitted, at the connection to each cargo tank, with a shut-off device capable of withstanding a detonation, where each cargo tank is fitted with a vacuum valve capable of withstanding a deflagration and a high-velocity vent valve capable of withstanding steady burning.

Only substances which do not mix and which do not react dangerously with each other may be carried simultaneously in cargo tanks connected to a common vapour pipe.

9.3.2.23 *Pressure tests*

- 9.3.2.23.1 The cargo tanks, residual cargo tanks, cofferdams, piping for loading and unloading shall be subjected to initial tests before being put into service and thereafter at prescribed intervals.

Where a heating system is provided inside the cargo tanks, the heating coils shall be subjected to initial tests before being put into service and thereafter at prescribed intervals.

- 9.3.2.23.2 The test pressure for the cargo tanks and residual cargo tanks shall be not less than 1.3 times the construction pressure. The test pressure for the cofferdams and open cargo tanks shall be not less than 10 kPa (0.10 bar) gauge pressure.

- 9.3.2.23.3 The test pressure for piping for loading and unloading shall be not less than 1,000 kPa (10 bar) gauge pressure.

- 9.3.2.23.4 The maximum intervals for the periodic tests shall be 11 years.

- 9.3.2.23.5 The procedure for pressure tests shall comply with the provisions established by the competent authority or a recognised classification society.

9.3.2.24 (*Reserved*)

9.3.2.25 *Pumps and piping*

- 9.3.2.25.1 Pumps, compressors and accessory loading and unloading piping shall be placed in the cargo area. Cargo pumps shall be capable of being shut down from the cargo area and, in addition, from a position outside the cargo area. Cargo pumps situated on deck shall be located not

less than 6.00 m from entrances to, or openings of, the accommodation and service spaces outside the cargo area.

- 9.3.2.25.2
- (a) Piping for loading and unloading shall be independent of any other piping of the vessel. No cargo piping shall be located below deck, except those inside the cargo tanks and inside the cargo pump-room.
 - (b) The piping for loading and unloading shall be arranged so that, after loading or unloading operations, the liquid remaining in these pipes may be safely removed and may flow either into the vessel's tanks or the tanks ashore.
 - (c) Piping for loading and unloading shall be clearly distinguishable from other piping, e.g. by means of colour marking.
 - (d) The piping for loading and unloading located on deck, with the exception of the shore connections, shall be located not less than a quarter of the vessel's breadth from the outer shell.
 - (e) The shore connections shall be located not less than 6.00 m from the entrances to, or openings of, the accommodation and service spaces outside the cargo area.
 - (f) Each shore connection of the vapour pipe and shore connections of the piping for loading and unloading, through which the loading or unloading operation is carried out, shall be fitted with a shut-off device. However, each shore connection shall be fitted with a blind flange when it is not in operation.
 - (g) *(Deleted)*
 - (h) The flanges and stuffing boxes shall be provided with a spray protection device.
 - (i) Piping for loading and unloading, and vapour pipes, shall not have flexible connections fitted with sliding seals.

9.3.2.25.3 The distance referred to in 9.3.2.25.1 and 9.3.2.25.2 (e) may be reduced to 3.00 m if a transverse bulkhead complying with 9.3.2.10.2 is situated at the end of the cargo area. The openings shall be provided with doors.

The following notice shall be displayed on the doors:

**Do not open during loading and unloading without
the permission of the master.
Close immediately.**

- 9.3.2.25.4
- (a) Every component of the piping for loading and unloading shall be electrically connected to the hull.
 - (b) The piping for loading shall extend down to the bottom of the cargo tanks.
- 9.3.2.25.5 The stop valves or other shut-off devices of the piping for loading and unloading shall indicate whether they are open or shut.
- 9.3.2.25.6 The piping for loading and unloading shall have, at the test pressure, the required elasticity, leakproofness and resistance to pressure.

9.3.2.25.7 The piping for loading and unloading shall be fitted with pressure gauges at the outlet of the pumps. The permissible maximum overpressure or vacuum value shall be indicated on each measuring device. Readings shall be possible in all weather conditions.

9.3.2.25.8 (a) When piping for loading and unloading are used for supplying the cargo tanks with washing or ballast water, the suctions of these pipes shall be located within the cargo area but outside the cargo tanks.

Pumps for tank washing systems with associated connections may be located outside the cargo area, provided the discharge side of the system is arranged in such a way that the suction is not possible through that part.

A spring-loaded non-return valve shall be provided to prevent any gases from being expelled from the cargo area through the tank washing system.

(b) A non-return valve shall be fitted at the junction between the water suction pipe and the cargo loading pipe.

9.3.2.25.9 The permissible loading and unloading flows shall be calculated.

Calculations concern the permissible maximum loading and unloading flow for each cargo tank or each group of cargo tanks, taking into account the design of the ventilation system. These calculations shall take into consideration the fact that in the event of an unforeseen cut-off of the gas return piping or the compensation piping of the shore facility, the safety devices of the cargo tanks will prevent pressure in the cargo tanks from exceeding the following values:

over-pressure: 115% of the opening pressure of the high-velocity vent valve;

vacuum pressure: not more than the construction vacuum pressure but not exceeding 5 kPa (0.05 bar).

The main factors to be considered are the following:

1. Dimensions of the ventilation system of the cargo tanks;
2. Gas formation during loading: multiply the largest loading flow by a factor of not less than 1.25;
3. Density of the vapour mixture of the cargo based on 50% volume vapour and 50% volume air;
4. Loss of pressure through ventilation pipes, valves and fittings. Account will be taken of a 30% clogging of the mesh of the flame-arrester;
5. Chocking pressure of the safety valves.

The permissible maximum loading and unloading pressure for each cargo tank or for each group of cargo tanks shall be given in an on-board instruction.

9.3.2.25.10 (*Deleted*)

9.3.2.25.11 If the vessel is carrying several dangerous substances liable to react dangerously with each other, a separate pump with its own piping for loading and unloading shall be installed for each substance. The piping shall not pass through a cargo tank containing dangerous substances with which the substance in question is liable to react.

9.3.2.26 *Tanks and receptacles for residual products and receptacles for slops*

9.3.2.26.1 If vessels are provided with a tank for residual products, it shall comply with the provisions of 9.3.2.26.3 and 9.3.2.26.4. Receptacles for residual products and receptacles for slops shall be located only in the cargo area. During the filling of the receptacles for residual products, means for collecting any leakage shall be placed under the filling connections.

9.3.2.26.2 Receptacles for slops shall be fire resistant and shall be capable of being closed with lids (drums with removable heads, code 1A2, ADR). The receptacles for slops shall be marked and be easy to handle.

9.3.2.26.3 The maximum capacity of a tank for residual products is 30 m³.

9.3.2.26.4 The tank for residual products shall be equipped with:

- pressure-relief and vacuum relief valves.

The high velocity vent valve shall be so regulated as not to open during carriage. This condition is met when the opening pressure of the valve meets the conditions set out in column (10) of Table C of Chapter 3.2;

When anti-explosion protection is required in column (17) of Table C of Chapter 3.2, the vacuum-relief valve shall be capable of withstanding deflagrations and the high-velocity vent valve shall withstand steady burning;

- a level indicator;
- connections with shut-off devices, for pipes and hose assemblies.

Receptacles for residual products shall be equipped with:

- a connection enabling gases released during filling to be evacuated safely;
- a possibility of indicating the degree of filling;
- connections with shut-off devices, for pipes and hose assemblies.

Receptacles for residual products shall be connected to the vapour pipe of cargo tanks only for the time necessary to fill them in accordance with 7.2.4.15.2.

Receptacles for residual products and receptacles for slops placed on the deck shall be located at a minimum distance from the hull equal to one quarter of the vessel's breadth.

9.3.2.27 (*Reserved*)

9.3.2.28 *Water-spray system*

When water-spraying is required in column (9) of Table C of Chapter 3.2, a water-spray system shall be installed in the cargo area on deck to enable gas emissions from loading to be precipitated and to cool the tops of cargo tanks by spraying water over the whole surface so as to avoid safely the activation of the high-velocity vent valve at 50 kPa (0.5 bar).

The gas precipitation system shall be fitted with a connection device for supply from a shore installation.

The spray nozzles shall be so installed that the entire cargo deck area is covered and the gases released are precipitated safely.

The system shall be capable of being put into operation from the wheelhouse and from the deck. Its capacity shall be such that when all the spray nozzles are in operation, the outflow is not less than 50 litres per square metre of deck area and per hour.

9.3.2.29-
9.3.2.30 (Reserved)

9.3.2.31 Engines

9.3.2.31.1 Only internal combustion engines running on fuel with a flashpoint of more than 55° C are allowed.

9.3.2.31.2. Ventilation inlets of the engine room, and when the engines do not take in air directly from the engine room, air intakes of the engines shall be located not less than 2.00 m from the cargo area.

9.3.2.31.3 Sparking shall not be possible within the cargo area.

9.3.2.31.4 The surface temperature of the outer parts of engines used during loading or unloading operations, as well as that of their air inlets and exhaust ducts shall not exceed the allowable temperature according to the temperature class of the substances carried. This provision does not apply to engines installed in service spaces provided the provisions of 9.3.2.52.3 are fully complied with.

9.3.2.31.5 The ventilation in the closed engine room shall be designed so that, at an ambient temperature of 20 °C, the average temperature in the engine room does not exceed 40° C.

9.3.2.32 Oil fuel tanks

9.3.2.32.1 Where the vessel is provided with hold spaces, the double bottoms within these spaces may be arranged as oil fuel tanks, provided their depth is not less than 0.6 m.

Oil fuel pipes and openings of such tanks are not permitted in the hold space.

9.3.2.32.2 The open ends of the air pipes of all oil fuel tanks shall extend to not less than 0.5 m above the open deck. Their open ends and the open ends of overflow pipes leading to the deck shall be fitted with a protective device consisting of a gauze diaphragm or a perforated plate.

9.3.2.33 (Reserved)

9.3.2.34 Exhaust pipes

9.3.2.34.1 Exhausts shall be evacuated from the vessel into the open air either upwards through an exhaust pipe or through the shell plating. The exhaust outlet shall be located not less than 2.00 m from the cargo area. The exhaust pipes of engines shall be arranged so that the exhausts are led away from the vessel. The exhaust pipes shall not be located within the cargo area.

9.3.2.34.2 Exhaust pipes shall be provided with a device preventing the escape of sparks, e.g. spark arresters.

9.3.2.35 *Bilge pumping and ballasting arrangements*

9.3.2.35.1 Bilge and ballast pumps for spaces within the cargo area shall be installed within such area.

This provision does not apply to:

- double-hull spaces and double bottoms which do not have a common boundary wall with the cargo tanks;
- cofferdams, double-hull spaces, hold spaces and double bottoms where ballasting is carried out using the piping of the fire-fighting system in the cargo area and bilge-pumping is performed using eductors.

9.3.2.35.2 Where the double bottom is used as a liquid oil fuel tank, it shall not be connected to the bilge piping system.

9.3.2.35.3 Where the ballast pump is installed in the cargo area, the standpipe and its outboard connection for suction of ballast water shall be located within the cargo area but outside the cargo tanks.

9.3.2.35.4 A cargo pump-room below deck shall be capable of being drained in an emergency by an installation located in the cargo area and independent from any other installation. This installation shall be provided outside the cargo pump-room.

9.3.2.36-
9.3.2.39 (*Reserved*)

9.3.2.40 *Fire-extinguishing arrangements*

9.3.2.40.1 A fire-extinguishing system shall be installed on the vessel. This system shall comply with the following requirements:

- It shall be supplied by two independent fire or ballast pumps, one of which shall be ready for use at any time. These pumps and their means of propulsion and electrical equipment shall not be installed in the same space;
- It shall be provided with a water main fitted with at least three hydrants in the cargo area above deck. Three suitable and sufficiently long hoses with jet/spray nozzles having a diameter of not less than 12 mm shall be provided. Alternatively one or more of the hose assemblies may be substituted by directable jet/spray nozzles having a diameter of not less than 12 mm. It shall be possible to reach any point of the deck in the cargo area simultaneously with at least two jets of water which do not emanate from the same hydrant.

A spring-loaded non-return valve shall be fitted to ensure that no gases can escape through the fire-extinguishing system into the accommodation or service spaces outside the cargo area;

- The capacity of the system shall be at least sufficient for a jet of water to have a minimum reach of not less than the vessel's breadth from any location on board with two spray nozzles being used at the same time;
- The water supply system shall be capable of being put into operation from the wheelhouse and from the deck;
- Measures shall be taken to prevent the freezing of fire-mains and hydrants.

9.3.2.40.2 In addition, the engine rooms, the pump-room and all spaces containing essential equipment (switchboards, compressors, etc.) for the refrigeration equipment, if any, shall be provided with a permanently fixed fire-extinguishing system meeting the following requirements:

9.3.2.40.2.1 *Extinguishing agents*

For the protection of spaces in engine rooms, boiler rooms and pump rooms, only permanently fixed fire-extinguishing systems using the following extinguishing agents are permitted:

- (a) CO₂ (carbon dioxide);
- (b) HFC 227 ea (heptafluoropropane);
- (c) IG-541 (52% nitrogen, 40% argon, 8% carbon dioxide).
- (d) FK-5-1-12 (dodecafluoro 2-methylpentane-3-one).

Other extinguishing agents are permitted only on the basis of recommendations by the Administrative Committee.

9.3.2.40.2.2 *Ventilation, air extraction*

- (a) The combustion air required by the combustion engines which ensure propulsion should not come from spaces protected by permanently fixed fire-extinguishing systems. This requirement is not mandatory if the vessel has two independent main engine rooms with a gastight separation or if, in addition to the main engine room, there is a separate engine room installed with a bow thruster that can independently ensure propulsion in the event of a fire in the main engine room.
- (b) All forced ventilation systems in the space to be protected shall be shut down automatically as soon as the fire-extinguishing system is activated.
- (c) All openings in the space to be protected which permit air to enter or gas to escape shall be fitted with devices enabling them to be closed rapidly. It shall be clear whether they are open or closed.
- (d) Air escaping from the pressure-relief valves of the pressurised air tanks installed in the engine rooms shall be evacuated to the open air.
- (e) Overpressure or negative pressure caused by the diffusion of the extinguishing agent shall not destroy the constituent elements of the space to be protected. It shall be possible to ensure the safe equalisation of pressure.
- (f) Protected spaces shall be provided with a means of extracting the extinguishing agent. If extraction devices are installed, it shall not be possible to start them up during extinguishing.

9.3.2.40.2.3 *Fire alarm system*

The space to be protected shall be monitored by an appropriate fire alarm system. The alarm signal shall be audible in the wheelhouse, the accommodation and the space to be protected.

9.3.2.40.2.4 *Piping system*

- (a) The extinguishing agent shall be routed to and distributed in the space to be protected by means of a permanent piping system. Piping installed in the space to be protected and the reinforcements it incorporates shall be made of steel. This shall not apply to the connecting nozzles of tanks and compensators provided that the materials used have equivalent fire-retardant properties. Piping shall be protected against corrosion both internally and externally.
- (b) The discharge nozzles shall be so arranged as to ensure the regular diffusion of the extinguishing agent. In particular, the extinguishing agent must also be effective beneath the floor.

9.3.2.40.2.5 *Triggering device*

- (a) Automatically activated fire-extinguishing systems are not permitted.
- (b) It shall be possible to activate the fire-extinguishing system from a suitable point located outside the space to be protected.
- (c) Triggering devices shall be so installed that they can be activated in the event of a fire and so that the risk of their breakdown in the event of a fire or an explosion in the space to be protected is reduced as far as possible.

Systems which are not mechanically activated shall be supplied from two energy sources independent of each other. These energy sources shall be located outside the space to be protected. The control lines located in the space to be protected shall be so designed as to remain capable of operating in the event of a fire for a minimum of 30 minutes. The electrical installations are deemed to meet this requirement if they conform to the IEC 60331-21:1999 standard.

When the triggering devices are so placed as not to be visible, the component concealing them shall carry the “Fire-fighting system” symbol, each side being not less than 10 cm in length, with the following text in red letters on a white ground:

Fire-extinguishing system

- (d) If the fire-extinguishing system is intended to protect several spaces, it shall comprise a separate and clearly-marked triggering device for each space.
- (e) The instructions shall be posted alongside all triggering devices and shall be clearly visible and indelible. The instructions shall be in a language the master can read and understand and if this language is not English, French or German, they shall be in English, French or German. They shall include information concerning:
 - (i) the activation of the fire-extinguishing system;
 - (ii) the need to ensure that all persons have left the space to be protected;
 - (iii) The correct behaviour of the crew in the event of activation and when accessing the space to be protected following activation or diffusion, in particular in respect of the possible presence of dangerous substances;
 - (iv) the correct behaviour of the crew in the event of the failure of the fire-extinguishing system to function properly.

- (f) The instructions shall mention that prior to the activation of the fire-extinguishing system, combustion engines installed in the space and aspirating air from the space to be protected, shall be shut down.

9.3.2.40.2.6 *Alarm device*

- (a) Permanently fixed fire-extinguishing systems shall be fitted with an audible and visual alarm device.
- (b) The alarm device shall be set off automatically as soon as the fire-extinguishing system is first activated. The alarm device shall function for an appropriate period of time before the extinguishing agent is released; it shall not be possible to turn it off.
- (c) Alarm signals shall be clearly visible in the spaces to be protected and their access points and be clearly audible under operating conditions corresponding to the highest possible sound level. It shall be possible to distinguish them clearly from all other sound and visual signals in the space to be protected.
- (d) Sound alarms shall also be clearly audible in adjoining spaces, with the communicating doors shut, and under operating conditions corresponding to the highest possible sound level.
- (e) If the alarm device is not intrinsically protected against short circuits, broken wires and drops in voltage, it shall be possible to monitor its operation.
- (f) A sign with the following text in red letters on a white ground shall be clearly posted at the entrance to any space the extinguishing agent may reach:

Warning, fire-extinguishing system!
Leave this space immediately when the ... (description) alarm is activated!

9.3.2.40.2.7 *Pressurised tanks, fittings and piping*

- (a) Pressurised tanks, fittings and piping shall conform to the requirements of the competent authority.
- (b) Pressurised tanks shall be installed in accordance with the manufacturer's instructions.
- (c) Pressurised tanks, fittings and piping shall not be installed in the accommodation.
- (d) The temperature of cabinets and storage spaces for pressurised tanks shall not exceed 50 °C.
- (e) Cabinets or storage spaces on deck shall be securely stowed and shall have vents so placed that in the event of a pressurised tank not being gastight, the escaping gas cannot penetrate into the vessel. Direct connections with other spaces are not permitted.

9.3.2.40.2.8 *Quantity of extinguishing agent*

If the quantity of extinguishing agent is intended for more than one space, the quantity of extinguishing agent available does not need to be greater than the quantity required for the largest of the spaces thus protected.

9.3.2.40.2.9 *Installation, maintenance, monitoring and documents*

- (a) The mounting or modification of the system shall only be performed by a company specialised in fire-extinguishing systems. The instructions (product data sheet, safety data sheet) provided by the manufacturer of the extinguishing agent or the system shall be followed.
- (b) The system shall be inspected by an expert:
 - (i) before being brought into service;
 - (ii) each time it is put back into service after activation;
 - (iii) after every modification or repair;
 - (iv) regularly, not less than every two years.
- (c) During the inspection, the expert is required to check that the system conforms to the requirements of 9.3.2.40.2.
- (d) The inspection shall include, as a minimum:
 - (i) an external inspection of the entire system;
 - (ii) an inspection to ensure that the piping is leakproof;
 - (iii) an inspection to ensure that the control and activation systems are in good working order;
 - (iv) an inspection of the pressure and contents of tanks;
 - (v) an inspection to ensure that the means of closing the space to be protected are leakproof;
 - (vi) an inspection of the fire alarm system;
 - (vii) an inspection of the alarm device.
- (e) The person performing the inspection shall establish, sign and date a certificate of inspection.
- (f) The number of permanently fixed fire-extinguishing systems shall be mentioned in the inspection certificate.

9.3.2.40.2.10 *Fire-extinguishing system operating with CO₂*

In addition to the requirements contained in 9.3.2.40.2.1 to 9.3.2.40.2.9, fire-extinguishing systems using CO₂ as an extinguishing agent shall conform to the following provisions:

- (a) Tanks of CO₂ shall be placed in a gastight space or cabinet separated from other spaces. The doors of such storage spaces and cabinets shall open outwards; they shall be capable of being locked and shall carry on the outside the symbol “Warning: danger”, not less than 5 cm high and “CO₂” in the same colours and the same size;
- (b) Storage cabinets or spaces for CO₂ tanks located below deck shall only be accessible from the outside. These spaces shall have an artificial ventilation system with

extractor hoods and shall be completely independent of the other ventilation systems on board;

- (c) The level of filling of CO₂ tanks shall not exceed 0.75 kg/l. The volume of depressurised CO₂ shall be taken to be 0.56 m³/kg;
- (d) The concentration of CO₂ in the space to be protected shall be not less than 40% of the gross volume of the space. This quantity shall be released within 120 seconds. It shall be possible to monitor whether diffusion is proceeding correctly;
- (e) The opening of the tank valves and the control of the diffusing valve shall correspond to two different operations;
- (f) The appropriate period of time mentioned in 9.3.2.40.2.6 (b) shall be not less than 20 seconds. A reliable installation shall ensure the timing of the diffusion of CO₂.

9.3.2.40.2.11 *Fire-extinguishing system operating with HFC-227 ea (heptafluoropropane)*

In addition to the requirements of 9.3.2.40.2.1 to 9.3.2.40.2.9, fire-extinguishing systems using HFC-227 ea as an extinguishing agent shall conform to the following provisions:

- (a) Where there are several spaces with different gross volumes, each space shall be equipped with its own fire-extinguishing system;
- (b) Every tank containing HFC-227 ea placed in the space to be protected shall be fitted with a device to prevent overpressure. This device shall ensure that the contents of the tank are safely diffused in the space to be protected if the tank is subjected to fire, when the fire-extinguishing system has not been brought into service;
- (c) Every tank shall be fitted with a device permitting control of the gas pressure;
- (d) The level of filling of tanks shall not exceed 1.15 kg/l. The specific volume of depressurised HFC-227 ea shall be taken to be 0.1374 m³/kg;
- (e) The concentration of HFC-227 ea in the space to be protected shall be not less than 8% of the gross volume of the space. This quantity shall be released within 10 seconds;
- (f) Tanks of HFC-227 ea shall be fitted with a pressure monitoring device which triggers an audible and visual alarm in the wheelhouse in the event of an unscheduled loss of propellant gas. Where there is no wheelhouse, the alarm shall be triggered outside the space to be protected;
- (g) After discharge, the concentration in the space to be protected shall not exceed 10.5% (volume);
- (h) The fire-extinguishing system shall not comprise aluminium parts.

9.3.2.40.2.12 *Fire-extinguishing system operating with IG-541*

In addition to the requirements of 9.3.2.40.2.1 to 9.3.2.40.2.9, fire-extinguishing systems using IG-541 as an extinguishing agent shall conform to the following provisions:

- (a) Where there are several spaces with different gross volumes, every space shall be equipped with its own fire-extinguishing system;

- (b) Every tank containing IG-541 placed in the space to be protected shall be fitted with a device to prevent overpressure. This device shall ensure that the contents of the tank are safely diffused in the space to be protected if the tank is subjected to fire, when the fire-extinguishing system has not been brought into service;
- (c) Each tank shall be fitted with a device for checking the contents;
- (d) The filling pressure of the tanks shall not exceed 200 bar at a temperature of +15 °C;
- (e) The concentration of IG-541 in the space to be protected shall be not less than 44% and not more than 50% of the gross volume of the space. This quantity shall be released within 120 seconds.

9.3.2.40.2.13 *Fire-extinguishing system operating with FK-5-1-12*

In addition to the requirements of 9.3.2.40.2.1 to 9.3.2.40.2.9, fire-extinguishing systems using FK-5-1-12 as an extinguishing agent shall comply with the following provisions:

- (a) Where there are several spaces with different gross volumes, every space shall be equipped with its own fire-extinguishing system;
- (b) Every tank containing FK-5-1-12 placed in the space to be protected shall be fitted with a device to prevent overpressure. This device shall ensure that the contents of the tank are safely diffused in the space to be protected if the tank is subjected to fire, when the fire-extinguishing system has not been brought into service;
- (c) Every tank shall be fitted with a device permitting control of the gas pressure;
- (d) The level of filling of tanks shall not exceed 1.00 kg/l. The specific volume of depressurized FK-5-1-12 shall be taken to be 0.0719 m³/kg;
- (e) The volume of FK-5-1-12 in the space to be protected shall be not less than 5.5% of the gross volume of the space. This quantity shall be released within 10 seconds;
- (f) Tanks of FK-5-1-12 shall be fitted with a pressure monitoring device which triggers an audible and visual alarm in the wheelhouse in the event of an unscheduled loss of extinguishing agent. Where there is no wheelhouse, the alarm shall be triggered outside the space to be protected;
- (g) After discharge, the concentration in the space to be protected shall not exceed 10.0%.

9.3.2.40.2.14 *Fixed fire-extinguishing system for physical protection*

In order to ensure physical protection in the engine rooms, boiler rooms and pump rooms, permanently fixed fire-extinguishing systems are accepted solely on the basis of recommendations by the Administrative Committee.

9.3.2.40.3 The two hand fire-extinguishers referred to in 8.1.4 shall be located in the cargo area.

9.3.2.40.4 The fire-extinguishing agent and the quantity contained in the permanently fixed fire-extinguishing system shall be suitable and sufficient for fighting fires.

9.3.2.41 *Fire and naked light*

9.3.2.41.1 The outlets of funnels shall be located not less than 2.00 m from the cargo area. Arrangements shall be provided to prevent the escape of sparks and the entry of water.

9.3.2.41.2 Heating, cooking and refrigerating appliances shall not be fuelled with liquid fuels, liquid gas or solid fuels.

The installation in the engine room or in another separate space of heating appliances fuelled with liquid fuel having a flash-point above 55 °C is, however, permitted.

Cooking and refrigerating appliances are permitted only in the accommodation.

9.3.2.41.3 Only electrical lighting appliances are permitted.

9.3.2.42 *Cargo heating system*

9.3.2.42.1 Boilers which are used for heating the cargo shall be fuelled with a liquid fuel having a flashpoint of more than 55 °C. They shall be placed either in the engine room or in another separate space below deck and outside the cargo area, which is accessible from the deck or from the engine room.

9.3.2.42.2 The cargo heating system shall be designed so that the cargo cannot penetrate into the boiler in the case of a leak in the heating coils. A cargo heating system with artificial draught shall be ignited electrically.

9.3.2.42.3 The ventilation system of the engine room shall be designed taking into account the air required for the boiler.

9.3.2.42.4 Where the cargo heating system is used during loading, unloading or gas-freeing, the service space which contains this system shall fully comply with the requirements of 9.3.2.52.3. This requirement does not apply to the inlets of the ventilation system. These inlets shall be located at a minimum distance of 2 m from the cargo area and 6 m from the openings of cargo tanks or residual cargo tanks, loading pumps situated on deck, openings of high velocity vent valves, pressure relief devices and shore connections of loading and unloading piping and must be located not less than 2 m above the deck.

The requirements of 9.3.2.52.3 are not applicable to the unloading of substances having a flash point of 60 °C or more when the temperature of the product is at least 15 K lower at the flash point.

9.3.2.43-
9.3.2.49 (*Reserved*)

9.3.2.50 *Documents concerning electrical installations*

9.3.2.50.1 In addition to the documents required in accordance with the Regulations referred to in 1.1.4.6, the following documents shall be on board:

- (a) a drawing indicating the boundaries of the cargo area and the location of the electrical equipment installed in this area;
- (b) a list of the electrical equipment referred to in (a) above including the following particulars:

machine or appliance, location, type of protection, type of protection against explosion, testing body and approval number;

- (c) a list of or general plan indicating the electrical equipment outside the cargo area which may be operated during loading, unloading or gas-freeing. All other electrical equipment shall be marked in red. See 9.3.2.52.3 and 9.3.2.52.4.

9.3.2.50.2 The documents listed above shall bear the stamp of the competent authority issuing the certificate of approval.

9.3.2.51 *Electrical installations*

9.3.2.51.1 Only distribution systems without return connection to the hull are permitted:

This provision does not apply to:

- active cathodic corrosion protection;
- local installations outside the cargo area (e.g. connections of starters of diesel engines);
- the device for checking the insulation level referred to in 9.3.2.51.2 below.

9.3.2.51.2 Every insulated distribution network shall be fitted with an automatic device with a visual and audible alarm for checking the insulation level.

9.3.2.51.3 For the selection of electrical equipment to be used in zones presenting an explosion risk, the explosion groups and temperature classes assigned to the substances carried in accordance with columns (15) and (16) of Table C of Chapter 3.2 shall be taken into consideration.

9.3.2.52 *Type and location of electrical equipment*

9.3.2.52.1 (a) Only the following equipment may be installed in cargo tanks, residual cargo tanks and piping for loading and unloading (comparable to zone 0):

- measuring, regulation and alarm devices of the EEx (ia) type of protection.

(b) Only the following equipment may be installed in the cofferdams, double-hull spaces, double bottoms and hold spaces (comparable to zone 1):

- measuring, regulation and alarm devices of the certified safe type;
- lighting appliances of the “flame-proof enclosure” or “pressurised enclosure” type of protection;
- hermetically sealed echo sounding devices the cables of which are led through thick-walled steel tubes with gastight connections up to the main deck;
- cables for the active cathodic protection of the shell plating in protective steel tubes such as those provided for echo sounding devices.

(c) Only the following equipment may be installed in the service spaces in the cargo area below deck (comparable to zone 1):

- measuring, regulation and alarm devices of the certified safe type;

- lighting appliances of the “flame-proof enclosure” or “apparatus protected by pressurization” type of protection;
 - motors driving essential equipment such as ballast pumps; they shall be of the certified safe type.
- (d) The control and protective equipment of the electrical equipment referred to in paragraphs (a), (b) and (c) above shall be located outside the cargo area if they are not intrinsically safe.
- (e) The electrical equipment in the cargo area on deck (comparable to zone 1) shall be of the certified safe type.

9.3.2.52.2 Accumulators shall be located outside the cargo area.

9.3.2.52.3 (a) Electrical equipment used during loading, unloading and gas-freeing during berthing and which are located outside the cargo area shall (comparable to zone 2) be at least of the “limited explosion risk” type.

(b) This provision does not apply to:

- (i) lighting installations in the accommodation, except for switches near entrances to accommodation;
- (ii) radiotelephone installations in the accommodation or the wheelhouse;
- (iii) mobile and fixed telephone installations in the accommodation or the wheelhouse;
- (iv) electrical installations in the accommodation, the wheelhouse or the service spaces outside the cargo areas if:

1. These spaces are fitted with a ventilation system ensuring an overpressure of 0.1 kPa (0.001 bar) and none of the windows is capable of being opened; the air intakes of the ventilation system shall be located as far away as possible, however, not less than 6.00 m from the cargo area and not less than 2.00 m above the deck;

2. The spaces are fitted with a gas detection system with sensors:

- at the suction inlets of the ventilation system;
- directly at the top edge of the sill of the entrance doors of the accommodation and service spaces;

3. The gas concentration measurement is continuous;

4. When the gas concentration reaches 20% of the lower explosive limit, the ventilators are switched off. In such a case and when the overpressure is not maintained or in the event of failure of the gas detection system, the electrical installations which do not comply with (a) above, shall be switched off. These operations shall be performed immediately and automatically and activate the emergency lighting in the accommodation, the wheelhouse and the service spaces, which shall comply at least with the “limited explosion risk” type. The switching-off shall be indicated in the accommodation and wheelhouse by visual and audible signals;

5. The ventilation system, the gas detection system and the alarm of the switch-off device fully comply with the requirements of (a) above;
6. The automatic switching-off device is set so that no automatic switch off may occur while the vessel is under way.

9.3.2.52.4 The electrical equipment which does not meet the requirements set out in 9.3.2.52.3 above together with its switches shall be marked in red. The disconnection of such equipment shall be operated from a centralised location on board.

9.3.2.52.5 An electric generator which is permanently driven by an engine and which does not meet the requirements of 9.3.2.52.3 above, shall be fitted with a switch capable of shutting down the excitation of the generator. A notice board with the operating instructions shall be displayed near the switch.

9.3.2.52.6 Sockets for the connection of signal lights and gangway lighting shall be permanently fitted to the vessel close to the signal mast or the gangway. Connecting and disconnecting shall not be possible except when the sockets are not live.

9.3.2.52.7 The failure of the power supply for the safety and control equipment shall be immediately indicated by visual and audible signals at the locations where the alarms are usually actuated.

9.3.2.53 *Earthing*

9.3.2.53.1 The metal parts of electrical appliances in the cargo area which are not live as well as protective metal tubes or metal sheaths of cables in normal service shall be earthed, unless they are so arranged that they are automatically earthed by bonding to the metal structure of the vessel.

9.3.2.53.2 The provisions of 9.3.2.53.1 above apply also to equipment having service voltages of less than 50 V.

9.3.2.53.3 Independent cargo tanks, metal intermediate bulk containers and tank-containers shall be earthed.

9.3.2.53.4 Receptacles for residual products shall be capable of being earthed.

9.3.2.54-
9.3.2.55 (*Reserved*)

9.3.2.56 *Electrical cables*

9.3.2.56.1 All cables in the cargo area shall have a metallic sheath.

9.3.2.56.2 Cables and sockets in the cargo area shall be protected against mechanical damage.

9.3.2.56.3 Movable cables are prohibited in the cargo area, except for intrinsically safe electric circuits or for the supply of signal lights and gangway lighting.

9.3.2.56.4 Cables of intrinsically safe circuits shall only be used for such circuits and shall be separated from other cables not intended for being used in such circuits (e.g. they shall not be installed together in the same string of cables and they shall not be fixed by the same cable clamps).

9.3.2.56.5 For movable cables intended for signal lights and gangway lighting, only sheathed cables of type H 07 RN-F in accordance with standard IEC 60 245-4:1994 or cables of at least

equivalent design having conductors with a cross-section of not less than 1.5 mm² shall be used.

These cables shall be as short as possible and installed so that damage is not likely to occur.

9.3.2.56.6 The cables required for the electrical equipment referred to in 9.3.2.51.1 (b) and (c) are accepted in cofferdams, double-hull spaces, double bottoms, hold spaces and service spaces below deck.

9.3.2.57-
9.3.2.59 (*Reserved*)

9.3.2.60 *Special equipment*

A shower and an eye and face bath shall be provided on the vessel at a location which is directly accessible from the cargo area.

9.3.2.61-
9.3.2.70 (*Reserved*)

9.3.2.71 *Admittance on board*

The notice boards displaying the prohibition of admittance in accordance with 8.3.3 shall be clearly legible from either side of the vessel.

9.3.2.72-
9.3.2.73 (*Reserved*)

9.3.2.74 *Prohibition of smoking, fire or naked light*

9.3.2.74.1 The notice boards displaying the prohibition of smoking in accordance with 8.3.4 shall be clearly legible from either side of the vessel.

9.3.2.74.2 Notice boards indicating the circumstances under which the prohibition is applicable shall be fitted near the entrances to the spaces where smoking or the use of fire or naked light is not always prohibited.

9.3.2.74.3 Ashtrays shall be provided close to each exit of the accommodation and the wheelhouse.

9.3.2.75-
9.3.2.91 (*Reserved*)

9.3.2.92 *Emergency exit*

Spaces the entrances or exits of which are likely to become partly or completely immersed in the damaged condition shall have an emergency exit which is situated not less than 0.10 m above the damage waterline. This requirement does not apply to forepeak and afterpeak.

9.3.2.93-
9.3.2.99 (*Reserved*)

9.3.3 Rules for construction of type N tank vessels

The rules for construction of 9.3.3.0 to 9.3.3.99 apply to type N tank vessels.

9.3.3.0 *Materials of construction*

- 9.3.3.0.1 (a) The vessel's hull and the cargo tanks shall be constructed of shipbuilding steel or other at least equivalent metal.

The independent cargo tanks may also be constructed of other materials, provided these have at least equivalent mechanical properties and resistance against the effects of temperature and fire.

- (b) Every part of the vessel including any installation and equipment which may come into contact with the cargo shall consist of materials which can neither be dangerously affected by the cargo nor cause decomposition of the cargo or react with it so as to form harmful or hazardous products. In case it has not been possible to examine this during classification and inspection of the vessel a relevant reservation shall be entered in the vessel substance list according to 1.16.1.2.5.
- (c) Inside vapour pipes and gas discharge pipes shall be protected against corrosion.

- 9.3.3.0.2 Except where explicitly permitted in 9.3.3.03 below or in the certificate of approval, the use of wood, aluminium alloys or plastic materials within the cargo area is prohibited.

- 9.3.3.0.3 (a) The use of wood, aluminium alloys or plastic materials within the cargo area is only permitted for:

- gangways and external ladders;
- movable items of equipment (aluminium gauging rods are, however, permitted provided that they are fitted with brass feet or protected in another way to avoid sparking);
- chocking of cargo tanks which are independent of the vessel's hull and chocking of installations and equipment;
- masts and similar round timber;
- engine parts;
- parts of the electrical installation;
- loading and unloading appliances;
- lids of boxes which are placed on the deck.

- (b) The use of wood or plastic materials within the cargo area is only permitted for:
- supports and stops of any kind.

- (c) The use of plastic materials or rubber within the cargo area is only permitted for:
- coating of cargo tanks and of piping for loading and unloading;
 - all kinds of gaskets (e.g. for dome or hatch covers);

- electric cables;
- hose assemblies for loading and unloading;
- insulation of cargo tanks and of piping for loading and unloading;
- photo-optical copies of the certificate of approval according to 8.1.2.6 or 8.1.2.7.

(d) All permanently fitted materials in the accommodation or wheelhouse, with the exception of furniture, shall not readily ignite. They shall not evolve fumes or toxic gases in dangerous quantities, if involved in a fire.

9.3.3.0.4 The paint used in the cargo area shall not be liable to produce sparks in case of impact.

9.3.3.0.5 The use of plastic material for vessel's boats is permitted only if the material does not readily ignite.

**9.3.3.1-
9.3.3.7** (*Reserved*)

9.3.3.8 *Classification*

9.3.3.8.1 The tank vessel shall be built under survey of a recognised classification society in accordance with the rules established by that classification society for its highest class, and the tank vessel shall be classed accordingly.

The vessel's class shall be continued.

The classification society shall issue a certificate certifying that the vessel is in conformity with the rules of this section (classification certificate).

The design pressure and the test pressure of cargo tanks shall be entered in the certificate.

If a vessel has cargo tanks with different valve opening pressures, the design and test pressures of each tank shall be entered in the certificate.

The classification society shall draw up a vessel substance list mentioning all the dangerous goods accepted for carriage by the tank vessel (see also 1.16.1.2.5).

9.3.3.8.2 The cargo pump-rooms shall be inspected by a recognised classification society whenever the certificate of approval has to be renewed as well as during the third year of validity of the certificate of approval. The inspection shall comprise at least:

- an inspection of the whole system for its condition, for corrosion, leakage or conversion works which have not been approved;
- a checking of the condition of the gas detection system in the cargo pump-rooms.

Inspection certificates signed by the recognised classification society with respect to the inspection of the cargo pump-rooms shall be kept on board. The inspection certificates shall at least include particulars of the above inspection and the results obtained as well as the date of the inspection.

9.3.3.8.3 The condition of the gas detection system referred to in 9.3.3.52.3 shall be checked by a recognised classification society whenever the certificate of approval has to be renewed and during the third year of validity of the certificate of approval. A certificate signed by the recognised classification society shall be kept on board.

9.3.3.8.4 9.3.3.8.2 and 9.3.3.8.3, checking of the condition of the gas detection system, do not apply to open type N.

9.3.3.9 (Reserved)

9.3.3.10 *Protection against the penetration of gases*

9.3.3.10.1 The vessel shall be designed so as to prevent gases from penetrating into the accommodation and the service spaces.

9.3.3.10.2 Outside the cargo area, the lower edges of door-openings in the sidewalls of superstructures and the coaming of access hatches to under-deck spaces shall have a height of not less than 0.50 m above the deck.

This requirement need not be complied with if the wall of the superstructures facing the cargo area extends from one side of the ship to the other and has doors the sills of which have a height of not less than 0.50 m above the deck. The height of this wall shall be not less than 2.00 m. In this case, the lower edges of door-openings in the sidewalls of superstructures and the coamings of access hatches behind this wall shall have a height of not less than 0.10 m above the deck. The sills of engine room doors and the coamings of its access hatches shall, however, always have a height of not less than 0.50 m.

9.3.3.10.3 In the cargo area, the lower edges of door-openings in the sidewalls of superstructures shall have a height of not less than 0.50 m above the deck and the sills of hatches and ventilation openings of premises located under the deck shall have a height of not less than 0.50 m above the deck. This requirement does not apply to access openings to double-hull and double bottom spaces.

9.3.3.10.4 The bulwarks, foot-rails etc. shall be provided with sufficiently large openings which are located directly above the deck.

9.3.3.10.5 9.3.3.10.1 to 9.3.3.10.4 above do not apply to open type N.

9.3.3.11 *Hold spaces and cargo tanks*

9.3.3.11.1 (a) The maximum permissible capacity of a cargo tank shall be determined in accordance with the following table:

$L \times B \times H$ (m ³)	Maximum permissible capacity of a cargo tank (m ³)
up to 600	$L \times B \times H \times 0.3$
600 to 3 750	$180 + (L \times B \times H - 600) \times 0.0635$
> 3 750	380

Alternative constructions in accordance with 9.3.4 are permitted. In the table above $L \times B \times H$ is the product of the main dimensions of the tank vessel in metres (according to the measurement certificate), where:

L = overall length of the hull in m;
B = extreme breadth of the hull in m;
H = shortest vertical distance between the top of the keel and the lowest point of the deck at the side of the vessel (moulded depth) within the cargo area in m;

where:

For trunk vessels, H shall be replaced by H', where H' shall be obtained from the following formula:

$$H' = H + \left(ht \times \frac{bt}{B} \times \frac{lt}{L} \right)$$

where:

ht = trunk height (distance between trunk deck and main deck measured on trunk side at L/2) in m;

bt = trunk breadth in m;

lt = trunk length in m.

- (b) The relative density of the substances to be carried shall be taken into consideration in the design of the cargo tanks. The maximum relative density shall be indicated in the certificate of approval.
- (c) When the vessel is provided with pressure tanks, these tanks shall be designed for a working pressure of 400 kPa (4 bar).
- (d) For vessels with a length of not more than 50.00 m, the length of a cargo tank shall not exceed 10.00 m; and

For vessels with a length of more than 50.00 m, the length of a cargo tank shall not exceed 0.20 L.

This provision does not apply to vessels with independent built-in cylindrical tanks having a length to diameter ratio ≤ 7 .

- 9.3.3.11.2 (a) The cargo tanks independent of the vessel's hull shall be fixed so that they cannot float.
- (b) The capacity of a suction well shall be limited to not more than 0.10 m³.
- 9.3.3.11.3 (a) The cargo tanks shall be separated by cofferdams of at least 0.60 m in width from the accommodation, engine room and service spaces outside the cargo area below deck or, if there are no such accommodation, engine room and service spaces, from the vessel's ends. Where the cargo tanks are installed in a hold space, a space of not less than 0.50 m shall be provided between such tanks and the end bulkheads of the hold space. In this case an insulated end bulkhead meeting the definition for Class "A-60" according to SOLAS 74, Chapter II-2, Regulation 3, shall be deemed equivalent to a cofferdam. For pressure cargo tanks, the 0.50 m distance may be reduced to 0.20 m.
- (b) Hold spaces, cofferdams and cargo tanks shall be capable of being inspected.
- (c) All spaces in the cargo area shall be capable of being ventilated. Means for checking their gas-free condition shall be provided.

9.3.3.11.4 The bulkheads bounding the cargo tanks, cofferdams and hold spaces shall be watertight. The cargo tanks and the bulkheads bounding the cargo area shall have no openings or penetrations below deck.

The bulkhead between the engine room and the cofferdam or service space in the cargo area or between the engine room and a hold space may be fitted with penetrations provided that they conform to the provisions of 9.3.3.17.5.

The bulkhead between the cargo tank and the cargo pump-room below deck may be fitted with penetrations provided that they conform to the provisions of 9.3.3.17.6. The bulkheads between the cargo tanks may be fitted with penetrations provided that the loading and unloading piping are fitted with shut-off devices in the cargo tank from which they come. These pipes shall be fitted at least 0.60m above the bottom. The shut-off devices shall be capable of being activated from the deck.

9.3.3.11.5 Double-hull spaces and double bottoms in the cargo area shall be arranged for being filled with ballast water only. Double bottoms may, however, be used as oil fuel tanks, provided they comply with the provisions of 9.3.3.32.

9.3.3.11.6 (a) A cofferdam, the centre part of a cofferdam or another space below deck in the cargo area may be arranged as a service space, provided the bulkheads bounding the service space extend vertically to the bottom. This service space shall only be accessible from the deck.

(b) The service space shall be watertight with the exception of its access hatches and ventilation inlets.

(c) No piping for loading and unloading shall be fitted within the service space referred to under 9.3.3.11.4 above.

Piping for loading and unloading may be fitted in the cargo pump-rooms below deck only when they conform to the provisions of 9.3.3.17.6.

9.3.3.11.7 Where independent cargo tanks are used, or for double-hull construction where the cargo tanks are integrated in the vessel's structure, the space between the wall of the vessel and wall of the cargo tanks shall be not less than 0.60 m.

The space between the bottom of the vessel and the bottom of the cargo tanks shall be not less than 0.50 m. The space may be reduced to 0.40 m under the pump sumps.

The vertical space between the suction well of a cargo tank and the bottom structures shall be not less than 0.10 m.

When a hull is constructed in the cargo area as a double hull with independent cargo tanks located in hold spaces, the above values are applicable to the double hull. If in this case the minimum values for inspections of independent tanks referred to in 9.3.3.11.9 are not feasible, it must be possible to remove the cargo tanks easily for inspection.

9.3.3.11.8 Where service spaces are located in the cargo area under deck, they shall be arranged so as to be easily accessible and to permit persons wearing protective clothing and breathing apparatus to safely operate the service equipment contained therein. They shall be designed so as to allow injured or unconscious personnel to be removed from such spaces without difficulties, if necessary by means of fixed equipment.

9.3.3.11.9 Cofferdams, double-hull spaces, double bottoms, cargo tanks, hold spaces and other accessible spaces within the cargo area shall be arranged so that they may be completely

inspected and cleaned. The dimensions of openings except for those of double-hull spaces and double bottoms which do not have a wall adjoining the cargo tanks shall be sufficient to allow a person wearing breathing apparatus to enter or leave the space without difficulties. These openings shall have a minimum cross-section of 0.36 m² and a minimum side length of 0.50 m. They shall be designed so as to allow injured or unconscious personnel to be removed from the bottom of such a space without difficulties, if necessary by means of fixed equipment. In these spaces the free penetration width shall not be less than 0.50 m in the sector intended for the penetration. In double bottoms this distance may be reduced to 0.45 m.

Cargo tanks may have circular openings with a diameter of not less than 0.68 m.

9.3.3.11.10 9.3.3.11.6 (c) above does not apply to open type N.

9.3.3.12 *Ventilation*

9.3.3.12.1 Each hold space shall have two openings the dimensions and location of which shall be such as to permit effective ventilation of any part of the hold space. If there are no such openings, it shall be possible to fill the hold spaces with inert gas or dry air.

9.3.3.12.2 Double-hull spaces and double bottoms within the cargo area which are not arranged for being filled with ballast water, hold spaces and cofferdams shall be provided with ventilation systems.

9.3.3.12.3 Any service spaces located in the cargo area below deck shall be provided with a system of forced ventilation with sufficient power for ensuring at least 20 changes of air per hour based on the volume of the space.

The ventilation exhaust ducts shall be located up to 50 mm above the bottom of the service space. The fresh air inlets shall be located in the upper part; they shall be not less than 2.00 m above the deck, not less than 2.00 m from the openings of the cargo tanks and not less than 6.00 m from the outlets of safety valves.

The extension pipes which may be necessary may be of the hinged type.

On board open type N vessels other suitable installations without ventilator fans shall be sufficient.

9.3.3.12.4 Ventilation of accommodation and service spaces shall be possible.

9.3.3.12.5 Ventilators used in the cargo area shall be designed so that no sparks may be emitted on contact of the impeller blades with the housing and no static electricity may be generated.

9.3.3.12.6 Notice boards shall be fitted at the ventilation inlets indicating the conditions under which they shall be closed. Any ventilation inlets of accommodation and service spaces leading outside shall be fitted with fire flaps. Such ventilation inlets shall be located not less than 2.00 m from the cargo area.

Ventilation inlets of service spaces in the cargo area below deck may be located within such area.

9.3.3.12.7 Flame-arresters prescribed in 9.3.3.20.4, 9.3.3.22.4, 9.3.3.22.5 and 9.3.3.26.4 shall be of a type approved for this purpose by the competent authority.

9.3.3.12.8 9.3.3.12.5, 9.3.3.12.6 and 9.3.3.12.7 above do not apply to open type N.

9.3.3.13 *Stability (general)*

9.3.3.13.1 Proof of sufficient stability shall be furnished. This proof is not required for single hull vessels with cargo tanks the width of which is not more than 0.70 B.

9.3.3.13.2 The basic values for the stability calculation - the vessel's lightweight and location of the centre of gravity - shall be determined either by means of an inclining experiment or by detailed mass and moment calculation. In the latter case the lightweight of the vessel shall be checked by means of a lightweight test with a tolerance limit of $\pm 5\%$ between the mass determined by calculation and the displacement determined by the draught readings.

9.3.3.13.3 Proof of sufficient intact stability shall be furnished for all stages of loading and unloading and for the final loading condition for all the relative densities of the substances transported contained in the vessel substance list according to 1.16.1.2.5.

For every loading operation, taking account of the actual fillings and floating position of cargo tanks, ballast tanks and compartments, drinking water and sewage tanks and tanks containing products for the operation of the vessel, the vessel shall comply with the intact and damage stability requirements.

Intermediate stages during operations shall also be taken into consideration.

The proof of sufficient stability shall be shown for every operating, loading and ballast condition in the stability booklet, to be approved by the relevant classification society, which classes the vessel. If it is unpractical to pre-calculate the operating, loading and ballast conditions, a loading instrument approved by the recognised classification society which classes the vessel shall be installed and used which contains the contents of the stability booklet.

NOTE: *A stability booklet shall be worded in a form comprehensible for the responsible master and containing the following details:*

General description of the vessel:

- *General arrangement and capacity plans indicating the assigned use of compartments and spaces (cargo tanks, stores, accommodation, etc.);*
- *A sketch indicating the position of the draught marks referring to the vessel's perpendiculars;*
- *A scheme for ballast/bilge pumping and overflow prevention systems;*
- *Hydrostatic curves or tables corresponding to the design trim, and, if significant trim angles are foreseen during the normal operation of the vessel, curves or tables corresponding to such range of trim are to be introduced;*
- *Cross curves or tables of stability calculated on a free trimming basis, for the ranges of displacement and trim anticipated in normal operating conditions, with an indication of the volumes which have been considered buoyant;*
- *Tank sounding tables or curves showing capacities, centres of gravity, and free surface data for all cargo tanks, ballast tanks and compartments, drinking water and sewage water tanks and tanks containing products for the operation of the vessel;*

- *Lightship data (weight and centre of gravity) resulting from an inclining test or deadweight measurement in combination with a detailed mass balance or other acceptable measures. Where the above-mentioned information is derived from a sister vessel, the reference to this sister vessel shall be clearly indicated, and a copy of the approved inclining test report relevant to this sister vessel shall be included;*
- *A copy of the approved test report shall be included in the stability booklet;*
- *Operating loading conditions with all relevant details, such as:*
 - *Lightship data, tank fillings, stores, crew and other relevant items on board (mass and centre of gravity for each item, free surface moments for liquid loads);*
 - *Draughts amidships and at perpendiculars;*
 - *Metacentric height corrected for free surfaces effect;*
 - *Righting lever values and curve;*
 - *Longitudinal bending moments and shear forces at read-out points;*
 - *Information about openings (location, type of tightness, means of closure); and*
 - *Information for the master;*
- *Calculation of the influence of ballast water on stability with information on whether fixed level gauges for ballast tanks and compartments have to be installed or whether the ballast tanks or compartments shall only be completely full or completely empty when underway.*

9.3.3.14 *Stability (intact)*

9.3.3.14.1 For vessels with independent cargo tanks and for double-hull constructions with cargo tanks integrated in the frames of the vessel, the requirements for intact stability resulting from the damage stability calculation shall be fully complied with.

9.3.3.14.2 For vessels with cargo tanks of more than 0.70 B in width, proof shall be furnished that the following stability requirements have been complied with:

- (a) In the positive area of the righting lever curve up to immersion of the first non-watertight opening there shall be a righting lever (GZ) of not less than 0.10 m;
- (b) The surface of the positive area of the righting lever curve up to immersion of the first non-watertight opening and in any event up to an angle of heel $\leq 27^\circ$ shall not be less than 0.024 m.rad;
- (c) The metacentric height (GM) shall be not less than 0.10 m.

These conditions shall be met bearing in mind the influence of all free surfaces in tanks for all stages of loading and unloading.

9.3.3.15 *Stability (damaged condition)*

9.3.3.15.1 For vessels with independent cargo tanks and for double-hull vessels with cargo tanks integrated in the construction of the vessel, the following assumptions shall be taken into consideration for the damaged condition:

- (a) The extent of side damage is as follows:

longitudinal extent: at least 0.10 L, but not less than 5.00 m;

transverse extent: 0.59 m, or when applicable, the distance allowed by section 9.3.4, reduced by 0.01 m ;
vertical extent: from the base line upwards without limit.

(b) The extent of bottom damage is as follows:

longitudinal extent: at least 0.10 L, but not less than 5.00 m;
transverse extent: 3.00 m;
vertical extent: from the base 0.49 m upwards, the sump excepted.

(c) Any bulkheads within the damaged area shall be assumed damaged, which means that the location of bulkheads shall be chosen so as to ensure that the vessel remains afloat after the flooding of two or more adjacent compartments in the longitudinal direction.

The following provisions are applicable:

- For bottom damage, adjacent athwartship compartments shall also be assumed as flooded;
- The lower edge of any non-watertight openings (e.g. doors, windows, access hatchways) shall, at the final stage of flooding, be not less than 0.10 m above the damage waterline;
- In general, permeability shall be assumed to be 95%. Where an average permeability of less than 95% is calculated for any compartment, this calculated value obtained may be used.

However, the following minimum values shall be used:

- engine rooms: 85%;
- accommodation: 95%;
- double bottoms, oil fuel tanks, ballast tanks, etc., depending on whether, according to their function, they have to be assumed as full or empty for the vessel floating at the maximum permissible draught: 0% or 95%.

For the main engine room only the one-compartment standard need be taken into account, i.e. the end bulkheads of the engine room shall be assumed as not damaged.

9.3.3.15.2 At the stage of equilibrium (final stage of flooding), the angle of heel shall not exceed 12°. Non-watertight openings shall not be flooded before reaching the stage of equilibrium. If such openings are immersed before that stage, the corresponding spaces shall be considered as flooded for the purpose of the stability calculation.

The positive range of the righting lever curve beyond the stage of equilibrium shall have a righting lever of ≥ 0.05 m in association with an area under the curve of ≥ 0.0065 m.rad. The minimum values of stability shall be satisfied up to immersion of the first non-watertight opening and in any event up to an angle of heel $\leq 27^\circ$. If non-watertight openings are immersed before that stage, the corresponding spaces shall be considered as flooded for the purposes of stability calculation.

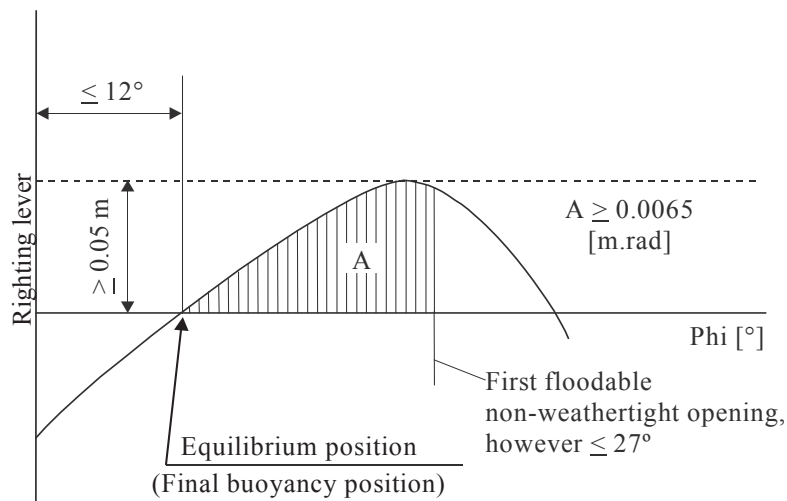

9.3.3.15.3 If openings through which undamaged compartments may additionally become flooded are capable of being closed watertight, the closing appliances shall be marked accordingly.

9.3.3.15.4 Where cross- or down-flooding openings are provided for reduction of unsymmetrical flooding, the time for equalization shall not exceed 15 minutes, if during the intermediate stages of flooding sufficient stability has been proved.

9.3.3.16 Engine rooms

9.3.3.16.1 Internal combustion engines for the vessel's propulsion as well as internal combustion engines for auxiliary machinery shall be located outside the cargo area. Entrances and other openings of engine rooms shall be at a distance of not less than 2.00 m from the cargo area.

9.3.3.16.2 The engine rooms shall be accessible from the deck; the entrances shall not face the cargo area. Where the doors are not located in a recess whose depth is at least equal to the door width, the hinges shall face the cargo area.

9.3.3.16.3 The last sentence of 9.3.3.16.2 does not apply to oil separator or supply vessels.

9.3.3.17 Accommodation and service spaces

9.3.3.17.1 Accommodation spaces and the wheelhouse shall be located outside the cargo area forward of the fore vertical plane or abaft the aft vertical plane bounding the part of the cargo area below deck. Windows of the wheelhouse which are located not less than 1.00 m above the bottom of the wheelhouse may tilt forward.

9.3.3.17.2 Entrances to spaces and openings of superstructures shall not face the cargo area. Doors opening outward and not located in a recess whose depth is at least equal to the width of the doors shall have their hinges face the cargo area.

9.3.3.17.3 Entrances from the deck and openings of spaces facing the weather shall be capable of being closed. The following instruction shall be displayed at the entrance of such spaces:

**Do not open during loading and unloading without
the permission of the master.
Close immediately.**

9.3.3.17.4 Entrances and windows of superstructures and accommodation spaces which can be opened as well as other openings of these spaces shall be located not less than 2.00 m from the cargo

area. No wheelhouse doors and windows shall be located within 2.00 m from the cargo area, except where there is no direct connection between the wheelhouse and the accommodation.

- 9.3.3.17.5
- (a) Driving shafts of the bilge or ballast pumps may penetrate through the bulkhead between the service space and the engine room, provided the arrangement of the service space is in compliance with 9.3.3.11.6.
 - (b) The penetration of the shaft through the bulkhead shall be gastight and shall have been approved by a recognised classification society.
 - (c) The necessary operating instructions shall be displayed.
 - (d) Penetrations through the bulkhead between the engine room and the service space in the cargo area and the bulkhead between the engine room and the hold spaces may be provided for electrical cables, hydraulic lines and piping for measuring, control and alarm systems, provided that the penetrations have been approved by a recognised classification society. The penetrations shall be gastight. Penetrations through a bulkhead with an “A-60” fire protection insulation according to SOLAS 74, Chapter II-2, Regulation 3, shall have an equivalent fire protection.
 - (e) Pipes may penetrate the bulkhead between the engine room and the service space in the cargo area provided that these are pipes between the mechanical equipment in the engine room and the service space which do not have any openings within the service space and which are provided with shut-off devices at the bulkhead in the engine room.
 - (f) Notwithstanding 9.3.3.11.4, pipes from the engine room may pass through the service space in the cargo area or a cofferdam or a hold space or a double-hull space to the outside provided that within the service space or cofferdam or hold space or double-hull space they are of the thick-walled type and have no flanges or openings.
 - (g) Where a driving shaft of auxiliary machinery penetrates through a wall located above the deck the penetration shall be gastight.

9.3.3.17.6 A service space located within the cargo area below deck shall not be used as a cargo pump-room for the loading and unloading system, except where:

- the cargo pump-room is separated from the engine room or from service spaces outside the cargo area by a cofferdam or a bulkhead with an “A-60” fire protection insulation according to SOLAS 74, Chapter II-2, Regulation 3, or by a service space or a hold space;
- the “A-60” bulkhead required above does not include penetrations referred to in 9.3.3.17.5 (a);
- ventilation exhaust outlets are located not less than 6.00 m from entrances and openings of the accommodation and service spaces outside the cargo area;
- the access hatches and ventilation inlets can be closed from the outside;
- all piping for loading and unloading as well as those of stripping systems are provided with shut-off devices at the pump suction side in the cargo pump-room immediately at the bulkhead. The necessary operation of the control devices in the pump-room, starting of pumps and necessary control of the liquid flow rate shall be effected from the deck;

- the bilge of the cargo pump-room is equipped with a gauging device for measuring the filling level which activates a visual and audible alarm in the wheelhouse when liquid is accumulating in the cargo pump-room bilge;
- the cargo pump-room is provided with a permanent gas detection system which automatically indicates the presence of explosive gases or lack of oxygen by means of direct-measuring sensors and which actuates a visual and audible alarm when the gas concentration has reached 20% of the lower explosive limit. The sensors of this system shall be placed at suitable positions at the bottom and directly below the deck.

Measurement shall be continuous.

The audible and visual alarms are installed in the wheelhouse and in the cargo pump-room and, when the alarm is actuated, the loading and unloading system is shut down. Failure of the gas detection system shall be immediately signalled in the wheelhouse and on deck by means of audible and visual alarms;

- the ventilation system prescribed in 9.3.3.12.3 has a capacity of not less than 30 changes of air per hour based on the total volume of the service space.

9.3.3.17.7 The following instruction shall be displayed at the entrance of the cargo pump-room:

**Before entering the cargo pump-room check whether
it is free from gases and contains sufficient oxygen.
Do not open doors and entrance openings without
the permission of the master.
Leave immediately in the event of alarm.**

9.3.3.17.8 9.3.3.17.5 (g), 9.3.3.17.6 and 9.3.3.17.7 do not apply to open type N.

9.3.3.17.2, last sentence, 9.3.3.17.3, last sentence and 9.3.3.17.4 do not apply to oil separator and supply vessels.

9.3.3.18 *Inerting facility*

In cases in which inerting or blanketing of the cargo is prescribed, the vessel shall be equipped with an inerting system.

This system shall be capable of maintaining a permanent minimum pressure of 7 kPa (0.07 bar) in the spaces to be inerted. In addition, the inerting system shall not increase the pressure in the cargo tank to a pressure greater than that at which the pressure valve is regulated. The set pressure of the vacuum-relief valve shall be 3.5 kPa (0.035 bar).

A sufficient quantity of inert gas for loading or unloading shall be carried or produced on board if it is not possible to obtain it on shore. In addition, a sufficient quantity of inert gas to offset normal losses occurring during carriage shall be on board.

The premises to be inerted shall be equipped with connections for introducing the inert gas and monitoring systems so as to ensure the correct atmosphere on a permanent basis.

When the pressure or the concentration of inert gas in the gaseous phase falls below a given value, this monitoring system shall activate an audible and visible alarm in the wheelhouse. When the wheelhouse is unoccupied, the alarm shall also be perceptible in a location occupied by a crew member.

9.3.3.19 (*Reserved*)

9.3.3.20 *Arrangement of cofferdams*

9.3.3.20.1 Cofferdams or cofferdam compartments remaining once a service space has been arranged in accordance with 9.3.3.11.6 shall be accessible through an access hatch.

If, however, the cofferdam is connected to a double-hull space, it is sufficient for it to be accessible from that space. For openings giving access to double-hull spaces on deck the last sentence of 9.3.2.10.3 remains applicable. In this case an arrangement shall be made for possible monitoring in order to ascertain from the deck whether the cofferdam is empty.

9.3.3.20.2 Cofferdams shall be capable of being filled with water and emptied by means of a pump. Filling shall be effected within 30 minutes. These requirements are not applicable when the bulkhead between the engine room and the cofferdam has an "A-16" fire protection insulation according to SOLAS 74, Chapter II-2, Regulation 3.

The cofferdams shall not be fitted with inlet valves.

9.3.3.20.3 No fixed pipe shall permit connection between a cofferdam and other piping of the vessel outside the cargo area.

9.3.3.20.4 The ventilation openings of cofferdams shall be fitted with a flame-arrester.

9.3.3.20.5 9.3.3.20.4 above does not apply to open type N.

9.3.3.20.2 above does not apply to oil separator and supply vessels.

9.3.3.21 *Safety and control installations*

9.3.3.21.1 Cargo tanks shall be provided with the following equipment:

- (a) a mark inside the tank indicating the liquid level of 97%;
- (b) a level gauge;
- (c) a level alarm device which is activated at the latest when a degree of filling of 90% is reached;
- (d) a high level sensor for actuating the facility against overflowing when a degree of filling of 97.5% is reached;
- (e) an instrument for measuring the pressure of the vapour phase inside the cargo tank;
- (f) an instrument for measuring the temperature of the cargo if in column (9) of Table C of Chapter 3.2 a heating installation is required or if in column (20) a possibility of heating the cargo is required or if a maximum temperature is indicated;
- (g) a connection for a sampling device, closed or partially closed, and/or at least one sampling opening as required in column (13) of Table C of Chapter 3.2.

9.3.3.21.2 When the degree of filling in per cent is determined, an error of not more than 0.5% is permitted. It shall be calculated on the basis of the total cargo tank capacity including the expansion trunk.

9.3.3.21.3 The level gauge shall allow readings from the control position of the shut-off devices of the particular cargo tank. The permissible maximum filling level of the cargo tank shall be marked on each level gauge.

Permanent reading of the overpressure and vacuum shall be possible from a location from which loading or unloading operations may be interrupted. The permissible maximum overpressure and vacuum shall be marked on each level gauge.

Readings shall be possible in all weather conditions.

9.3.3.21.4 The level alarm device shall give a visual and audible warning on board when actuated. The level alarm device shall be independent of the level gauge.

9.3.3.21.5 (a) The high level sensor referred to in 9.3.3.21.1 (d) above shall give a visual and audible alarm on board and at the same time actuate an electrical contact which in the form of a binary signal interrupts the electric current loop provided and fed by the shore facility, thus initiating measures at the shore facility against overflowing during loading operations. The signal shall be transmitted to the shore facility via a watertight two-pin plug of a connector device in accordance with standard EN 60309-2:1999 for direct current of 40 to 50 volts, identification colour white, position of the nose 10 h.

The plug shall be permanently fitted to the vessel close to the shore connections of the loading and unloading piping.

The high level sensor shall also be capable of switching off the vessel's own discharging pump.

The high level sensor shall be independent of the level alarm device, but it may be connected to the level gauge.

(b) On board oil separator vessels the sensor referred to in 9.3.3.21.1 (d) shall activate a visual and audible alarm and switch off the pump used to evacuate bilge water.

(c) Supply vessels and other vessels which may be delivering products required for operation shall be equipped with a transshipment facility compatible with European standard EN 12 827:1996 and a rapid closing device enabling refuelling to be interrupted. It shall be possible to actuate this rapid closing device by means of an electrical signal from the overflow prevention system. The electrical circuits actuating the rapid closing device shall be secured according to the quiescent current principle or other appropriate error detection measures. The state of operation of electrical circuits which cannot be controlled using the quiescent current principle shall be capable of being easily checked.

It shall be possible to actuate the rapid closing device independently of the electrical signal.

The rapid closing device shall actuate a visual and an audible alarm on board.

(d) During discharging by means of the on-board pump, it shall be possible for the shore facility to switch it off. For this purpose, an independent intrinsically safe power line, fed by the vessel, shall be switched off by the shore facility by means of an electrical contact.

It shall be possible for the binary signal of the shore facility to be transmitted via a watertight two-pole socket or a connector device in accordance with standard EN 60309-2:1999, for direct current of 40 to 50 volts, identification colour white, position of the nose 10 h.

This socket shall be permanently fitted to the vessel close to the shore connections of the unloading piping.

- 9.3.3.21.6 The visual and audible signals given by the level alarm device shall be clearly distinguishable from those of the high level sensor.

The visual alarm shall be visible at each control position on deck of the cargo tank stop valves. It shall be possible to easily check the functioning of the sensors and electric circuits or these shall be intrinsically safe apparatus.

- 9.3.3.21.7 When the pressure or temperature exceeds a set value, instruments for measuring the vacuum or overpressure of the gaseous phase in the cargo tank or the temperature of the cargo, shall activate a visual and audible alarm in the wheelhouse. When the wheelhouse is unoccupied, the alarm shall also be perceptible in a location occupied by a crew member.

When the pressure exceeds the set value during loading and unloading, the instrument for measuring the pressure shall, by means of the plug referred to in 9.3.3.21.5, initiate simultaneously an electrical contact which shall put into effect measures to interrupt the loading and unloading operation. If the vessel's own discharge pump is used, it shall be switched off automatically.

The instrument for measuring the overpressure or vacuum shall activate the alarm at latest when an overpressure is reached equal to 1.15 times the opening pressure of the pressure relief device, or a vacuum pressure equal to the construction vacuum pressure but not exceeding 5 kPa. The maximum allowable temperature is indicated in column (20) of Table C of Chapter 3.2. The sensors for the alarms mentioned in this paragraph may be connected to the alarm device of the sensor.

When it is prescribed in column (20) of Table C of Chapter 3.2 the instrument for measuring the overpressure of the gaseous phase shall activate a visible and audible alarm in the wheelhouse when the overpressure exceeds 40 kPa during the voyage. When the wheelhouse is unoccupied, the alarm shall also be perceptible in a location occupied by a crew member.

- 9.3.3.21.8 Where the control elements of the shut-off devices of the cargo tanks are located in a control room, it shall be possible to stop the loading pumps and read the level gauges in the control room, and the visual and audible warning given by the level alarm device, the high level sensor referred to in 9.3.3.21.1 (d) and the instruments for measuring the pressure and temperature of the cargo shall be noticeable in the control room and on deck.

Satisfactory monitoring of the cargo area shall be ensured from the control room.

- 9.3.3.21.9 9.3.3.21.1 (e), 9.3.3.21.7 as regards measuring the pressure, do not apply to open type N with flame-arrester and to open type N.

9.3.3.21.1 (b), (c) and (g), 9.3.3.21.3 and 9.3.3.21.4 do not apply to oil separator and supply vessels.

Screens in sampling openings are not required on board open type N tank vessels.

9.3.3.21.1 (f) and 9.3.3.21.7 do not apply to supply vessels.

9.3.3.21.5 (a) does not apply to oil separator vessels.

9.3.3.22 *Cargo tank openings*

- 9.3.3.22.1 (a) Cargo tank openings shall be located on deck in the cargo area.

- (b) Cargo tank openings with a cross-section of more than 0.10 m² and openings of safety devices for preventing overpressures shall be located not less than 0.50 m above deck.

9.3.3.22.2 Cargo tank openings shall be fitted with gastight closures capable of withstanding the test pressure in accordance with 9.3.3.23.2.

9.3.3.22.3 Closures which are normally used during loading or unloading operations shall not cause sparking when operated.

9.3.3.22.4 (a) Each cargo tank or group of cargo tanks connected to a common vapour pipe shall be fitted with safety devices for preventing unacceptable overpressures or vacuums.

These safety devices shall be as follows:

for the open N type:

- safety devices designed to prevent any accumulation of water and its penetration into the cargo tanks;

for the open N type with flame-arresters:

- safety equipment fitted with flame-arresters capable of withstanding steady burning and designed to prevent any accumulation of water and its penetration into the cargo tank;

for the closed N type:

- safety devices for preventing unacceptable overpressure or vacuum. Where anti-explosion protection is required in column (17) of Table C of Chapter 3.2, the vacuum valve shall be fitted with a flame arrester capable of withstanding a deflagration and the pressure relief valve with a high-velocity vent valve acting as a flame arrester capable of withstanding steady burning. Gases shall be discharged upwards. The opening pressure of the high-velocity vent valve and the opening pressure of the vacuum valve shall be permanently marked on the valves.
- a connection for the safe return ashore of gases expelled during loading;
- a device for the safe depressurisation of the cargo tanks consisting of at least a flame-arrester capable of withstanding steady burning and a stop valve the position of which shall clearly indicate whether it is open or shut.

(b) The outlets of high-velocity vent valves shall be located not less than 2.00 m above the deck and at a distance of not less than 6.00 m from the accommodation and from the service spaces outside the cargo area. This height may be reduced when within a radius of 1.00 m round the outlet of the high-velocity vent valve, there is no equipment, no work is being carried out and signs indicate the area. The setting of the high-velocity vent valves shall be such that during the transport operation they do not blow off until the maximum permissible working pressure of the cargo tanks is reached.

9.3.3.22.5 (a) Insofar as anti-explosion protection is prescribed in column (17) of Table C of Chapter 3.2, a vapour pipe connecting two or more cargo tanks shall be fitted, at the connection to each cargo tank, with a flame arrester with a fixed or spring-loaded plate stack, capable of withstanding detonation. This equipment may consist of:

- (i) a flame arrester fitted with a fixed plate stack, where each cargo tank is fitted with a vacuum valve capable of withstanding a deflagration and a high-velocity vent valve capable of withstanding steady burning;
- (ii) a flame arrester fitted with a spring-loaded plate stack, where each cargo tank is fitted with a vacuum valve capable of withstanding a deflagration;
- (iii) a flame arrester with a fixed plate stack;
- (iv) a flame arrester with a fixed plate stack, where the pressure measurement device is fitted with an alarm system in accordance with 9.3.3.21.7;
- (v) a flame arrester with a spring-loaded plate stack, where the pressure measurement device is fitted with an alarm system in accordance with 9.3.3.21.7.

Only substances which do not mix and which do not react dangerously with each other may be carried simultaneously in cargo tanks connected to a common vapour pipe;

or

- (b) Insofar as anti-explosion protection is prescribed in column (17) of Table C of Chapter 3.2, a vapour pipe connecting two or more cargo tanks shall be fitted, at the connection to each cargo tank, with a pressure/vacuum valve incorporating a flame arrester capable of withstanding a detonation/deflagration.

Only substances which do not mix and which do not react dangerously with each other may be carried simultaneously in cargo tanks connected to a common vapour pipe;

or

- (c) Insofar as anti-explosion protection is prescribed in column (17) of Table C of Chapter 3.2, an independent vapour pipe for each cargo tank, fitted with a pressure/vacuum valve incorporating a flame arrester capable of withstanding a deflagration and a high-velocity vent valve incorporating a flame arrester capable of withstanding steady burning. Several different substances may be carried simultaneously;

or

- (d) Insofar as anti-explosion protection is prescribed in column (17) of Table C of Chapter 3.2, a vapour pipe connecting two or more cargo tanks shall be fitted, at the connection to each cargo tank, with a shut-off device capable of withstanding a detonation, where each cargo tank is fitted with a vacuum valve capable of withstanding a deflagration and a high-velocity vent valve capable of withstanding steady burning.

Only substances which do not mix and which do not react dangerously with each other may be carried simultaneously in cargo tanks connected to a common vapour pipe.

9.3.3.22.6 9.3.3.22.2, 9.3.3.22.4 (b) and 9.3.3.22.5 do not apply to open type N with flame-arrester and to open type N.

9.3.3.22.3 does not apply to open type N.

9.3.3.23 *Pressure tests*

9.3.3.23.1 The cargo tanks, residual cargo tanks, cofferdams, piping for loading and unloading, with the exception of discharge hoses shall be subjected to initial tests before being put into service and thereafter at prescribed intervals.

Where a heating system is provided inside the cargo tanks, the heating coils shall be subjected to initial tests before being put into service and thereafter at prescribed intervals.

9.3.3.23.2 The test pressure for the cargo tanks and residual cargo tanks shall be not less than 1.3 times the design pressure. The test pressure for the cofferdams and open cargo tanks shall be not less than 10 kPa (0.10 bar) gauge pressure.

9.3.3.23.3 The test pressure for piping for loading and unloading shall be not less than 1,000 kPa (10 bar) gauge pressure.

9.3.3.23.4 The maximum intervals for the periodic tests shall be 11 years.

9.3.3.23.5 The procedure for pressure tests shall comply with the provisions established by the competent authority or a recognised classification society.

9.3.3.24 (*Reserved*)

9.3.3.25 *Pumps and piping*

9.3.3.25.1 (a) Pumps and accessory loading and unloading piping shall be located in the cargo area.
(b) Cargo pumps shall be capable of being shut down from the cargo area and from a position outside the cargo area.

(c) Cargo pumps situated on deck shall be located not less than 6.00 m from entrances to, or openings of, the accommodation and service spaces outside the cargo area.

9.3.3.25.2 (a) Piping for loading and unloading shall be independent of any other piping of the vessel. No cargo piping shall be located below deck, except those inside the cargo tanks and inside the cargo pump-room.

(b) The piping for loading and unloading shall be arranged so that, after loading or unloading operations, the liquid remaining in these pipes may be safely removed and may flow either into the vessel's cargo tanks or the tanks ashore.

(c) Piping for loading and unloading shall be clearly distinguishable from other piping, e.g. by means of colour marking.

(d) (*Reserved*)

(e) The shore connections shall be located not less than 6.00 m from the entrances to, or openings of, the accommodation and service spaces outside the cargo area.

(f) Each shore connection of the vapour pipe and shore connections of the piping for loading and unloading, through which the loading or unloading operation is carried out, shall be fitted with a shut-off device. However, each shore connection shall be fitted with a blind flange when it is not in operation.

(g) (*Deleted*)

- (h) Piping for loading and unloading, and vapour pipes, shall not have flexible connections fitted with sliding seals.

9.3.3.25.3 The distance referred to in 9.3.3.25.1 (c) and 9.3.3.25.2 (e) may be reduced to 3.00 m if a transverse bulkhead complying with 9.3.3.10.2 is situated at the end of the cargo area. The openings shall be provided with doors.

The following notice shall be displayed on the doors:

**Do not open during loading and unloading without
the permission of the master.
Close immediately.**

9.3.3.25.4 (a) Every component of the piping for loading and unloading shall be electrically connected to the hull.

(b) The piping for loading shall extend down to the bottom of the cargo tanks.

9.3.3.25.5 The stop valves or other shut-off devices of the piping for loading and unloading shall indicate whether they are open or shut.

9.3.3.25.6 The piping for loading and unloading shall have, at the test pressure, the required elasticity, leakproofness and resistance to pressure.

9.3.3.25.7 The piping for loading and unloading shall be fitted with pressure gauges at the outlet of the pumps. The permissible maximum overpressure or vacuum value shall be indicated on each measuring device. Readings shall be possible in all weather conditions.

9.3.3.25.8 (a) When piping for loading and unloading are used for supplying the cargo tanks with washing or ballast water, the suction of these pipes shall be located within the cargo area but outside the cargo tanks.

Pumps for tank washing systems with associated connections may be located outside the cargo area, provided the discharge side of the system is arranged in such a way that suction is not possible through that part.

A spring-loaded non-return valve shall be provided to prevent any gases from being expelled from the cargo area through the tank washing system.

(b) A non-return valve shall be fitted at the junction between the water suction pipe and the cargo loading pipe.

9.3.3.25.9 The permissible loading and unloading flows shall be calculated. For open type N with flame-arrester and open type N the loading and unloading flows depend on the total cross-section of the exhaust ducts.

Calculations concerning the permissible maximum loading and unloading flows for each cargo tank or each group of cargo tanks, taking into account the design of the ventilation system. These calculations shall take into consideration the fact that in the event of an unforeseen cut-off of the gas return piping or the compensation piping of the shore facility, the safety devices of the cargo tanks will prevent pressure in the cargo tanks from exceeding the following values:

over pressure: 115% of the opening pressure of the high velocity vent valve.

vacuum pressure: not more than the construction vacuum pressure but not exceeding 5 kPa (0.05 bar).

The main factors to be considered are the following:

1. Dimensions of the ventilation system of the cargo tanks;
2. Gas formation during loading: multiply the largest loading flow by a factor of not less than 1.25;
3. Density of the vapour mixture of the cargo based on 50% volume vapour of 50% volume air;
4. Loss of pressure through ventilation pipes, valves and fittings. Account will be taken of a 30% clogging of the mesh of the flame-arrester;
5. Chocking pressure of the safety valves.

The permissible maximum loading and unloading pressure for each cargo tank or for each group of cargo tanks shall be given in an on-board instruction.

9.3.3.25.10 *(Deleted)*

9.3.3.25.11 If the vessel is carrying several dangerous substances liable to react dangerously with each other, a separate pump with its own piping for loading and unloading shall be installed for each substance. The piping shall not pass through a cargo tank containing dangerous substances with which the substance in question is liable to react.

9.3.3.25.12 9.3.3.25.1 (a) and (c), 9.3.3.25.2 (a), last sentence and (e), 9.3.3.25.3 and 9.3.3.25.4 (a) do not apply to type N open unless the substance carried has corrosive properties (see column (5) of Table C of Chapter 3.2, hazard 8).

9.3.3.25.4 (b) does not apply to open type N.

9.3.3.25.2 (f), last sentence, 9.3.3.25.2 (g), 9.3.3.25.8 (a), last sentence and 9.3.3.25.10 do not apply to oil separator and supply vessels.

9.3.3.25.9 does not apply to oil separator vessels.

9.3.3.25.2 (h) does not apply to supply vessels.

9.3.3.26 *Receptacles for residual products and receptacles for slops*

9.3.3.26.1 If vessels are provided with a tank for residual products, it shall comply with the provisions of 9.3.3.26.3 and 9.3.3.26.4. Receptacles for residual products and receptacles for slops shall be located only in the cargo area. During filling of receptacles for residual products, means for collecting any leakage shall be placed under the filling connections.

9.3.3.26.2 Receptacles for slops shall be fire resistant and shall be capable of being closed with lids (drums with removable heads, code 1A2, ADR). The receptacles for slops shall be marked and easy to handle.

9.3.3.26.3 The maximum capacity of a tank for residual products is 30 m³.

9.3.3.26.4 The tank for residual products shall be equipped with:

- in the case of an open system:
 - a device for ensuring pressure equilibrium;
 - an ullage opening;
 - connections, with stop valves, for pipes and hose assemblies;
- in the case of a protected system:
 - a device for ensuring pressure equilibrium, fitted with a flame-arrester capable of withstanding steady burning;
 - an ullage opening;
 - connections, with stop valves, for pipes and hose assemblies;
- in the case of a closed system:
 - a vacuum valve and a high-velocity vent valve.

The high-velocity vent valve shall be so regulated that it does not open during carriage. This condition is met when the opening pressure of the valve meets the conditions required in column (10) of Table C of Chapter 3.2 for the substance to be carried. When anti-explosion protection is required in column (17) of Table C of Chapter 3.2, the vacuum valve shall be capable of withstanding deflagrations and the high-velocity vent valve steady burning;
 - a device for measuring the degree of filling;
 - connections, with stop valves, for pipes and hose assemblies.

Receptacles for residual products shall be equipped with:

- a connection enabling gases released during filling to be evacuated safely;
- a possibility of indicating the degree of filling;
- connections with shut-off devices, for pipes and hose assemblies.

Receptacles for residual products shall be connected to the vapour pipe of cargo tanks only for the time necessary to fill them in accordance with 7.2.4.15.2.

Receptacles for residual products and receptacles for slops placed on the deck shall be located at a minimum distance from the hull equal to one quarter of the vessel's breadth.

9.3.3.26.5 Paragraphs 9.3.3.26.1, 9.3.3.26.3 and 9.3.3.26.4 above do not apply to oil separator vessels.

9.3.3.27 *(Reserved)*

9.3.3.28 *Water-spray system*

When water-spraying is required in column (9) of Table C of Chapter 3.2, a water-spray system shall be installed in the cargo area on deck for the purpose of cooling the tops of cargo tanks by spraying water over the whole surface so as to avoid safely the activation of the high-velocity vent valve at 10 kPa or as regulated.

The spray nozzles shall be so installed that the entire cargo deck area is covered and the gases released are precipitated safely.

The system shall be capable of being put into operation from the wheelhouse and from the deck. Its capacity shall be such that when all the spray nozzles are in operation, the outflow is not less than 50 litres per square metre of deck area and per hour.

9.3.3.29-
9.3.3.30 (Reserved)

9.3.3.31 Engines

9.3.3.31.1 Only internal combustion engines running on fuel with a flashpoint of more than 55 °C are allowed.

9.3.3.31.2 Ventilation inlets of the engine room and, when the engines do not take in air directly from the engine room, air intakes of the engines shall be located not less than 2.00 m from the cargo area.

9.3.3.31.3 Sparking shall not be possible within the cargo area.

9.3.3.31.4 The surface temperature of the outer parts of engines used during loading or unloading operations, as well as that of their air inlets and exhaust ducts shall not exceed the allowable temperature according to the temperature class of the substances carried. This provision does not apply to engines installed in service spaces provided the provisions of 9.3.3.52.3 are fully complied with.

9.3.3.31.5 The ventilation in the closed engine room shall be designed so that, at an ambient temperature of 20 °C, the average temperature in the engine room does not exceed 40 °C.

9.3.3.31.6 9.3.3.31.2 above does not apply to oil separator or supply vessels.

9.3.3.32 Oil fuel tanks

9.3.3.32.1 Where the vessel is provided with hold spaces, the double bottoms within these spaces may be arranged as oil fuel tanks, provided their depth is not less than 0.6 m.

Oil fuel pipes and openings of such tanks are not permitted in the hold space.

9.3.3.32.2 The open ends of the air pipes of each oil fuel tank shall extend to 0.5 m above the open deck. These open ends and the open ends of overflow pipes leading to the deck shall be provided with a protective device consisting of a gauze diaphragm or a perforated plate.

9.3.3.33 (Reserved)

9.3.3.34 Exhaust pipes

9.3.3.34.1 Exhaust shall be evacuated from the vessel into the open air either upwards through an exhaust pipe or through the shell plating. The exhaust outlet shall be located not less than 2.00 m from the cargo area. The exhaust pipes of engines shall be arranged so that the exhausts are led away from the vessel. The exhaust pipes shall not be located within the cargo area.

9.3.3.34.2 Exhaust pipes shall be provided with a device preventing the escape of sparks, e.g. spark arresters.

9.3.3.34.3 The distance prescribed in 9.3.3.34.1 above does not apply to oil separator or supply vessels.

9.3.3.35 *Bilge pumping and ballasting arrangements*

9.3.3.35.1 Bilge and ballast pumps for spaces within the cargo area shall be installed within such area.

This provision does not apply to:

- double-hull spaces and double bottoms which do not have a common boundary wall with the cargo tanks;
- cofferdams, double-hull, double bottom and hold spaces where ballasting is carried out using the piping of the fire-fighting system in the cargo area and bilge-pumping is performed using eductors.

9.3.3.35.2 Where the double bottom is used as a liquid oil fuel tank, it shall not be connected to the bilge piping system.

9.3.3.35.3 Where the ballast pump is installed in the cargo area, the standpipe and its outboard connection for suction of ballast water shall be located within the cargo area but outside the cargo tanks.

9.3.3.35.4 A cargo pump-room below deck shall be capable of being drained in an emergency by an installation located in the cargo area and independent from any other installation. The installation shall be provided outside the cargo pump-room.

9.3.3.36-
9.3.3.39 (*Reserved*)

9.3.3.40 *Fire-extinguishing arrangements*

9.3.3.40.1 A fire-extinguishing system shall be installed on the vessel. This system shall comply with the following requirements:

- It shall be supplied by two independent fire or ballast pumps, one of which shall be ready for use at any time. These pumps and their means of propulsion and electrical equipment shall not be installed in the same space;
- It shall be provided with a water main fitted with at least three hydrants in the cargo area above deck. Three suitable and sufficiently long hoses with jet/spray nozzles having a diameter of not less than 12 mm shall be provided. Alternatively one or more of the hose assemblies may be substituted by directable jet/spray nozzles having a diameter of not less than 12 mm. It shall be possible to reach any point of the deck in the cargo area simultaneously with at least two jets of water which do not emanate from the same hydrant;

A spring-loaded non-return valve shall be fitted to ensure that no gases can escape through the fire-extinguishing system into the accommodation or service spaces outside the cargo area;

- The capacity of the system shall be at least sufficient for a jet of water to have a minimum reach of not less than the vessel's breadth from any location on board with two spray nozzles being used at the same time;
- The water supply system shall be capable of being put into operation from the wheelhouse and from the deck;

- Measures shall be taken to prevent the freezing of fire-mains and hydrants.

9.3.3.40.2 In addition the engine room, the pump-room and all spaces containing essential equipment (switchboards, compressors, etc.) for the refrigeration equipment, if any, shall be provided with a fixed fire-extinguishing system meeting the following requirements:

9.3.3.40.2.1 *Extinguishing agents*

For the protection of spaces in engine rooms, boiler rooms and pump rooms, only permanently fixed fire-extinguishing systems using the following extinguishing agents are permitted:

- (a) CO₂ (carbon dioxide).
- (b) HFC 227 ea (heptafluoropropane).
- (c) IG-541 (52% nitrogen, 40% argon, 8% carbon dioxide).
- (d) FK-5-1-12 (dodecafluoro 2-methylpentane-3-one).

Other extinguishing agents are permitted only on the basis of recommendations by the Administrative Committee.

9.3.3.40.2.2 *Ventilation, air extraction*

- (a) The combustion air required by the combustion engines which ensure propulsion should not come from spaces protected by permanently fixed fire-extinguishing systems. This requirement is not mandatory if the vessel has two independent main engine rooms with a gastight separation or if, in addition to the main engine room, there is a separate engine room installed with a bow thruster that can independently ensure propulsion in the event of a fire in the main engine room.
- (b) All forced ventilation systems in the space to be protected shall be shut down automatically as soon as the fire-extinguishing system is activated.
- (c) All openings in the space to be protected which permit air to enter or gas to escape shall be fitted with devices enabling them to be closed rapidly. It shall be clear whether they are open or closed.
- (d) Air escaping from the pressure-relief valves of the pressurised air tanks installed in the engine rooms shall be evacuated to the open air.
- (e) Overpressure or negative pressure caused by the diffusion of the extinguishing agent shall not destroy the constituent elements of the space to be protected. It shall be possible to ensure the safe equalisation of pressure.
- (f) Protected spaces shall be provided with a means of extracting the extinguishing agent. If extraction devices are installed, it shall not be possible to start them up during extinguishing.

9.3.3.40.2.3 *Fire alarm system*

The space to be protected shall be monitored by an appropriate fire alarm system. The alarm signal shall be audible in the wheelhouse, the accommodation and the space to be protected.

9.3.3.40.2.4 *Piping system*

- (a) The extinguishing agent shall be routed to and distributed in the space to be protected by means of a permanent piping system. Piping installed in the space to be protected and the reinforcements it incorporates shall be made of steel. This shall not apply to the connecting nozzles of tanks and compensators provided that the materials used have equivalent fire-retardant properties. Piping shall be protected against corrosion both internally and externally.
- (b) The discharge nozzles shall be so arranged as to ensure the regular diffusion of the extinguishing agent. In particular, the extinguishing agent must also be effective beneath the floor.

9.3.3.40.2.5 *Triggering device*

- (a) Automatically activated fire-extinguishing systems are not permitted.
- (b) It shall be possible to activate the fire-extinguishing system from a suitable point located outside the space to be protected.
- (c) Triggering devices shall be so installed that they can be activated in the event of a fire and so that the risk of their breakdown in the event of a fire or an explosion in the space to be protected is reduced as far as possible.

Systems which are not mechanically activated shall be supplied from two energy sources independent of each other. These energy sources shall be located outside the space to be protected. The control lines located in the space to be protected shall be so designed as to remain capable of operating in the event of a fire for a minimum of 30 minutes. The electrical installations are deemed to meet this requirement if they conform to the IEC 60331-21:1999 standard.

When the triggering devices are so placed as not to be visible, the component concealing them shall carry the “Fire-fighting system” symbol, each side being not less than 10 cm in length, with the following text in red letters on a white ground:

Fire-extinguishing system

- (d) If the fire-extinguishing system is intended to protect several spaces, it shall comprise a separate and clearly-marked triggering device for each space.
- (e) The instructions shall be posted alongside all triggering devices and shall be clearly visible and indelible. The instructions shall be in a language the master can read and understand and if this language is not English, French or German, they shall be in English, French or German. They shall include information concerning:
 - (i) the activation of the fire-extinguishing system;
 - (ii) the need to ensure that all persons have left the space to be protected;
 - (iii) the correct behaviour of the crew in the event of activation and when accessing the space to be protected following activation or diffusion, in particular in respect of the possible presence of dangerous substances;
 - (iv) the correct behaviour of the crew in the event of the failure of the fire-extinguishing system to function properly.

- (f) The instructions shall mention that prior to the activation of the fire-extinguishing system, combustion engines installed in the space and aspirating air from the space to be protected, shall be shut down.

9.3.3.40.2.6 *Alarm device*

- (a) Permanently fixed fire-extinguishing systems shall be fitted with an audible and visual alarm device.
- (b) The alarm device shall be set off automatically as soon as the fire-extinguishing system is first activated. The alarm device shall function for an appropriate period of time before the extinguishing agent is released; it shall not be possible to turn it off;
- (c) Alarm signals shall be clearly visible in the spaces to be protected and their access points and be clearly audible under operating conditions corresponding to the highest possible sound level. It shall be possible to distinguish them clearly from all other sound and visual signals in the space to be protected.
- (d) Sound alarms shall also be clearly audible in adjoining spaces, with the communicating doors shut, and under operating conditions corresponding to the highest possible sound level.
- (e) If the alarm device is not intrinsically protected against short circuits, broken wires and drops in voltage, it shall be possible to monitor its operation.
- (f) A sign with the following text in red letters on a white ground shall be clearly posted at the entrance to any space the extinguishing agent may reach:

**Warning, fire-extinguishing system!
Leave this space immediately when the ... (description)
alarm is activated!**

9.3.3.40.2.7 *Pressurised tanks, fittings and piping*

- (a) Pressurised tanks, fittings and piping shall conform to the requirements of the competent authority.
- (b) Pressurised tanks shall be installed in accordance with the manufacturer's instructions.
- (c) Pressurised tanks, fittings and piping shall not be installed in the accommodation.
- (d) The temperature of cabinets and storage spaces for pressurised tanks shall not exceed 50 °C.
- (e) Cabinets or storage spaces on deck shall be securely stowed and shall have vents so placed that in the event of a pressurised tank not being gastight, the escaping gas cannot penetrate into the vessel. Direct connections with other spaces are not permitted.

9.3.3.40.2.8 *Quantity of extinguishing agent*

If the quantity of extinguishing agent is intended for more than one space, the quantity of extinguishing agent available does not need to be greater than the quantity required for the largest of the spaces thus protected.

9.3.3.40.2.9 *Installation, maintenance, monitoring and documents*

- (a) The mounting or modification of the system shall only be performed by a company specialised in fire-extinguishing systems. The instructions (product data sheet, safety data sheet) provided by the manufacturer of the extinguishing agent or the system shall be followed.
- (b) The system shall be inspected by an expert:
 - (i) before being brought into service;
 - (ii) each time it is put back into service after activation;
 - (iii) after every modification or repair;
 - (iv) regularly, not less than every two years.
- (c) During the inspection, the expert is required to check that the system conforms to the requirements of 9.3.3.40.2.
- (d) The inspection shall include, as a minimum:
 - (i) an external inspection of the entire system;
 - (ii) an inspection to ensure that the piping is leakproof;
 - (iii) an inspection to ensure that the control and activation systems are in good working order;
 - (iv) an inspection of the pressure and contents of tanks;
 - (v) an inspection to ensure that the means of closing the space to be protected are leakproof;
 - (vi) an inspection of the fire alarm system;
 - (vii) an inspection of the alarm device.
- (e) The person performing the inspection shall establish, sign and date a certificate of inspection.
- (f) The number of permanently fixed fire-extinguishing systems shall be mentioned in the inspection certificate.

9.3.3.40.2.10 *Fire-extinguishing system operating with CO₂*

In addition to the requirements contained in 9.3.3.40.2.1 to 9.3.3.40.2.9, fire-extinguishing systems using CO₂ as an extinguishing agent shall conform to the following provisions:

- (a) Tanks of CO₂ shall be placed in a gastight space or cabinet separated from other spaces. The doors of such storage spaces and cabinets shall open outwards; they shall be capable of being locked and shall carry on the outside the symbol “Warning: danger”, not less than 5 cm high and “CO₂” in the same colours and the same size;
- (b) Storage cabinets or spaces for CO₂ tanks located below deck shall only be accessible from the outside. These spaces shall have an artificial ventilation system with

extractor hoods and shall be completely independent of the other ventilation systems on board;

- (c) The level of filling of CO₂ tanks shall not exceed 0.75 kg/l. The volume of depressurised CO₂ shall be taken to be 0.56 m³/kg;
- (d) The concentration of CO₂ in the space to be protected shall be not less than 40% of the gross volume of the space. This quantity shall be released within 120 seconds. It shall be possible to monitor whether diffusion is proceeding correctly;
- (e) The opening of the tank valves and the control of the diffusing valve shall correspond to two different operations;
- (f) The appropriate period of time mentioned in 9.3.3.40.2.6 (b) shall be not less than 20 seconds. A reliable installation shall ensure the timing of the diffusion of CO₂.

9.3.3.40.2.11 *Fire-extinguishing system operating with HFC-227 ea (heptafluoropropane)*

In addition to the requirements of 9.3.3.40.2.1 to 9.3.3.40.2.9, fire-extinguishing systems using HFC-227 ea as an extinguishing agent shall conform to the following provisions:

- (a) Where there are several spaces with different gross volumes, each space shall be equipped with its own fire-extinguishing system;
- (b) Every tank containing HFC-227 ea placed in the space to be protected shall be fitted with a device to prevent overpressure. This device shall ensure that the contents of the tank are safely diffused in the space to be protected if the tank is subjected to fire, when the fire-extinguishing system has not been brought into service;
- (c) Every tank shall be fitted with a device permitting control of the gas pressure;
- (d) The level of filling of tanks shall not exceed 1.15 kg/l. The specific volume of depressurised HFC-227 ea shall be taken to be 0.1374 m³/kg;
- (e) The concentration of HFC-227 ea in the space to be protected shall be not less than 8% of the gross volume of the space. This quantity shall be released within 10 seconds;
- (f) Tanks of HFC-227 ea shall be fitted with a pressure monitoring device which triggers an audible and visual alarm in the wheelhouse in the event of an unscheduled loss of propellant gas. Where there is no wheelhouse, the alarm shall be triggered outside the space to be protected;
- (g) After discharge, the concentration in the space to be protected shall not exceed 10.5% (volume);
- (h) The fire-extinguishing system shall not comprise aluminium parts.

9.3.3.40.2.12 *Fire-extinguishing system operating with IG-541*

In addition to the requirements of 9.3.3.40.2.1 to 9.3.3.40.2.9, fire-extinguishing systems using IG-541 as an extinguishing agent shall conform to the following provisions:

- (a) Where there are several spaces with different gross volumes, every space shall be equipped with its own fire-extinguishing system;

- (b) Every tank containing IG-541 placed in the space to be protected shall be fitted with a device to prevent overpressure. This device shall ensure that the contents of the tank are safely diffused in the space to be protected if the tank is subjected to fire, when the fire-extinguishing system has not been brought into service;
- (c) Each tank shall be fitted with a device for checking the contents;
- (d) The filling pressure of the tanks shall not exceed 200 bar at a temperature of +15 °C;
- (e) The concentration of IG-541 in the space to be protected shall be not less than 44% and not more than 50% of the gross volume of the space. This quantity shall be released within 120 seconds.

9.3.3.40.2.13 *Fire-extinguishing system operating with FK-5-1-12*

In addition to the requirements of 9.3.3.40.2.1 to 9.3.3.40.2.9, fire-extinguishing systems using FK-5-1-12 as an extinguishing agent shall comply with the following provisions:

- (a) Where there are several spaces with different gross volumes, every space shall be equipped with its own fire-extinguishing system;
- (b) Every tank containing FK-5-1-12 placed in the space to be protected shall be fitted with a device to prevent overpressure. This device shall ensure that the contents of the tank are safely diffused in the space to be protected if the tank is subjected to fire, when the fire-extinguishing system has not been brought into service;
- (c) Every tank shall be fitted with a device permitting control of the gas pressure;
- (d) The level of filling of tanks shall not exceed 1.00 kg/l. The specific volume of depressurized FK-5-1-12 shall be taken to be 0.0719 m³/kg;
- (e) The volume of FK-5-1-12 in the space to be protected shall be not less than 5.5% of the gross volume of the space. This quantity shall be released within 10 seconds;
- (f) Tanks of FK-5-1-12 shall be fitted with a pressure monitoring device which triggers an audible and visual alarm in the wheelhouse in the event of an unscheduled loss of extinguishing agent. Where there is no wheelhouse, the alarm shall be triggered outside the space to be protected;
- (g) After discharge, the concentration in the space to be protected shall not exceed 10.0%.

9.3.3.40.2.14 *Fixed fire-extinguishing system for physical protection*

In order to ensure physical protection in the engine rooms, boiler rooms and pump rooms, permanently fixed fire-extinguishing systems are accepted solely on the basis of recommendations by the Administrative Committee.

9.3.3.40.3 The two hand fire-extinguishers referred to in 8.1.4 shall be located in the cargo area.

9.3.3.40.4 The fire-extinguishing agent and the quantity contained in the permanently fixed fire-extinguishing system shall be suitable and sufficient for fighting fires.

9.3.3.40.5 9.3.3.40.1 and 9.3.3.40.2 above do not apply to oil separator or supply vessels.

9.3.3.41 *Fire and naked light*

9.3.3.41.1 The outlets of funnels shall be located not less than 2.00 m from the cargo area. Arrangements shall be provided to prevent the escape of sparks and the entry of water.

9.3.3.41.2 Heating, cooking and refrigerating appliances shall not be fuelled with liquid fuels, liquid gas or solid fuels.

The installation in the engine room or in another separate space of heating appliances fuelled with liquid fuel having a flashpoint above 55 °C is, however, permitted.

Cooking and refrigerating appliances are permitted only in the accommodation.

9.3.3.41.3 Only electrical lighting appliances are permitted.

9.3.3.42 *Cargo heating system*

9.3.3.42.1 Boilers which are used for heating the cargo shall be fuelled with a liquid fuel having a flashpoint of more than 55 °C. They shall be placed either in the engine room or in another separate space below deck and outside the cargo area, which is accessible from the deck or from the engine room.

9.3.3.42.2 The cargo heating system shall be designed so that the cargo cannot penetrate into the boiler in the case of a leak in the heating coils. A cargo heating system with artificial draught shall be ignited electrically.

9.3.3.42.3 The ventilation system of the engine room shall be designed taking into account the air required for the boiler.

9.3.3.42.4 Where the cargo heating system is used during loading, unloading or gas-freeing, the service space which contains this system shall fully comply with the requirements of 9.3.3.52.3. This requirement does not apply to the inlets of the ventilation system. These inlets shall be located at a minimum distance of 2 m from the cargo area and 6 m from the openings of cargo tanks or residual cargo tanks, loading pumps situated on deck, openings of high-velocity vent valves, pressure relief devices and shore connections of loading and unloading piping and must be located not less than 2 m above the deck.

The requirements of 9.3.3.52.3 are not applicable to the unloading of substances having a flashpoint of 60 °C or more when the temperature of the product is at least 15 K lower at the flashpoint.

9.3.3.43-
9.3.3.49 (*Reserved*)

9.3.3.50 *Documents concerning electrical installations*

9.3.3.50.1 In addition to the documents required in accordance with the Regulations referred to in 1.1.4.6, the following documents shall be on board:

- (a) a drawing indicating the boundaries of the cargo area and the location of the electrical equipment installed in this area;
- (b) a list of the electrical equipment referred to in (a) above including the following particulars:

machine or appliance, location, type of protection, type of protection against explosion, testing body and approval number;

- (c) a list of or general plan indicating the electrical equipment outside the cargo area which may be operated during loading, unloading or gas-freeing. All other electrical equipment shall be marked in red. See 9.3.3.52.3 and 9.3.3.52.4.

9.3.3.50.2 The documents listed above shall bear the stamp of the competent authority issuing the certificate of approval.

9.3.3.51 *Electrical installations*

9.3.3.51.1 Only distribution systems without return connection to the hull are permitted.

This provision does not apply to:

- active cathodic corrosion protection;
- certain limited sections of the installations situated outside the cargo area (e.g. connections of starters of diesel engines);
- the device for checking the insulation level referred to in 9.3.3.51.2 below.

9.3.3.51.2 Every insulated distribution network shall be fitted with an automatic device with a visual and audible alarm for checking the insulation level.

9.3.3.51.3 For the selection of electrical equipment to be used in zones presenting an explosion risk, the explosion groups and temperature classes assigned to the substances carried in columns (15) and (16) of Table C of Chapter 3.2 shall be taken into consideration.

9.3.3.52 *Type and location of electrical equipment*

9.3.3.52.1 (a) Only the following equipment may be installed in cargo tanks, residual cargo tanks, and piping for loading and unloading (comparable to zone 0):

- measuring, regulation and alarm devices of the EEx (ia) type of protection.

(b) Only the following equipment may be installed in the cofferdams, double-hull spaces, double bottoms and hold spaces (comparable to zone 1):

- measuring, regulation and alarm devices of the certified safe type;
- lighting appliances of the “flame-proof enclosure” or “apparatus protected by pressurization” type of protection;
- hermetically sealed echo sounding devices the cables of which are led through thick-walled steel tubes with gastight connections up to the main deck;
- cables for the active cathodic protection of the shell plating in protective steel tubes such as those provided for echo sounding devices.

(c) Only the following equipment may be installed in the service spaces in the cargo area below deck (comparable to zone 1):

- measuring, regulation and alarm devices of the certified safe type;

- lighting appliances of the “flame-proof enclosure” or “apparatus protected by pressurization” type of protection;
 - motors driving essential equipment such as ballast pumps; they shall be of the certified safe type.
- (d) The control and protective equipment of the electrical equipment referred to in paragraphs (a), (b) and (c) above shall be located outside the cargo area if they are not intrinsically safe.
- (e) The electrical equipment in the cargo area on deck (comparable to zone 1) shall be of the certified safe type.

9.3.3.52.2 Accumulators shall be located outside the cargo area.

9.3.3.52.3 (a) Electrical equipment used during loading, unloading and gas-freeing during berthing and which are located outside the cargo area shall (comparable to zone 2) be at least of the “limited explosion risk” type.

(b) This provision does not apply to:

- (i) lighting installations in the accommodation, except for switches near entrances to accommodation;
- (ii) radiotelephone installations in the accommodation or the wheelhouse;
- (iii) mobile and fixed telephone installations in the accommodation or the wheelhouse;
- (iv) electrical installations in the accommodation, the wheelhouse or the service spaces outside the cargo areas if:

1. These spaces are fitted with a ventilation system ensuring an overpressure of 0.1 kPa (0.001 bar) and none of the windows is capable of being opened; the air intakes of the ventilation system shall be located as far away as possible, however, not less than 6.00 m from the cargo area and not less than 2.00 m above the deck;

2. The spaces are fitted with a gas detection system with sensors:

- at the suction inlets of the ventilation system;
- directly at the top edge of the sill of the entrance doors of the accommodation and service spaces;

3. The gas concentration measurement is continuous;

4. When the gas concentration reaches 20% of the lower explosive limit, the ventilators are switched off. In such a case and when the overpressure is not maintained or in the event of failure of the gas detection system, the electrical installations which do not comply with (a) above, shall be switched off. These operations shall be performed immediately and automatically and activate the emergency lighting in the accommodation, the wheelhouse and the service spaces, which shall comply at least with the “limited explosion risk” type. The switching-off shall be indicated in the accommodation and wheelhouse by visual and audible signals;

5. The ventilation system, the gas detection system and the alarm of the switch-off device fully comply with the requirements of (a) above;
6. The automatic switch-off device is set so that no automatic switching-off may occur while the vessel is under way.

9.3.3.52.4 The electrical equipment which does not meet the requirements set out in 9.3.3.52.3 above together with its switches shall be marked in red. The disconnection of such equipment shall be operated from a centralised location on board.

9.3.3.52.5 An electric generator which is permanently driven by an engine and which does not meet the requirements of 9.3.3.52.3 above, shall be fitted with a switch capable of shutting down the excitation of the generator. A notice board with the operating instructions shall be displayed near the switch.

9.3.3.52.6 Sockets for the connection of signal lights and gangway lighting shall be permanently fitted to the vessel close to the signal mast or the gangway. Connecting and disconnecting shall not be possible except when the sockets are not live.

9.3.3.52.7 The failure of the power supply for the safety and control equipment shall be immediately indicated by visual and audible signals at the locations where the alarms are usually actuated.

9.3.3.53 *Earthing*

9.3.3.53.1 The metal parts of electrical appliances in the cargo area which are not live as well as protective metal tubes or metal sheaths of cables in normal service shall be earthed, unless they are so arranged that they are automatically earthed by bonding to the metal structure of the vessel.

9.3.3.53.2 The provisions of 9.3.3.53.1 above apply also to equipment having service voltages of less than 50 V.

9.3.3.53.3 Independent cargo tanks shall be earthed.

9.3.3.53.4 Receptacles for residual products shall be capable of being earthed.

9.3.3.54-
9.3.3.55 (*Reserved*)

9.3.3.56 *Electrical cables*

9.3.3.56.1 All cables in the cargo area shall have a metallic sheath.

9.3.3.56.2 Cables and sockets in the cargo area shall be protected against mechanical damage.

9.3.3.56.3 Movable cables are prohibited in the cargo area, except for intrinsically safe electric circuits or for the supply of signal lights, gangway lighting and submerged pumps on board oil separator vessels.

9.3.3.56.4 Cables of intrinsically safe circuits shall only be used for such circuits and shall be separated from other cables not intended for being used in such circuits (e.g. they shall not be installed together in the same string of cables and they shall not be fixed by the same cable clamps).

9.3.3.56.5 For movable cables intended for signal lights, gangway lighting, and submerged pumps on board oil separator vessels, only sheathed cables of type H 07 RN-F in accordance with IEC

publication-60 245-4 (1994) or cables of at least equivalent design having conductors with a cross-section of not less than 1.5 mm² shall be used.

These cables shall be as short as possible and installed so that damage is not likely to occur.

9.3.3.56.6 The cables required for the electrical equipment referred to in 9.3.3.52.1 (b) and (c) are accepted in cofferdams, double-hull spaces, double bottoms, hold spaces and service spaces below deck. When the vessel is only authorized to carry substances for which no anti-explosion protection is required in column (17) of Table C in Chapter 3.2, cable penetration is permitted in the hold spaces.

9.3.3.57-
9.3.3.59 (*Reserved*)

9.3.3.60 *Special equipment*

A shower and an eye and face bath shall be provided on the vessel at a location which is directly accessible from the cargo area.

This requirement does not apply to oil separator and supply vessels.

9.3.3.61-
9.3.3.70 (*Reserved*)

9.3.3.71 *Admittance on board*

The notice boards displaying the prohibition of admittance in accordance with 8.3.3 shall be clearly legible from either side of the vessel.

9.3.3.72-
9.3.3.73 (*Reserved*)

9.3.3.74 *Prohibition of smoking, fire or naked light*

9.3.3.74.1 The notice boards displaying the prohibition of smoking in accordance with 8.3.4 shall be clearly legible from either side of the vessel.

9.3.3.74.2 Notice boards indicating the circumstances under which the prohibition is applicable shall be fitted near the entrances to the spaces where smoking or the use of fire or naked light is not always prohibited.

9.3.3.74.3 Ashtrays shall be provided close to each exit in the accommodation and the wheelhouse.

9.3.3.75-
9.3.3.91 (*Reserved*)

9.3.3.92 On board of tank vessels referred to in 9.3.3.11.7, spaces the entrances or exits of which are likely to become partly or completely immersed in the damaged condition shall have an emergency exit which is situated not less than 0.10 m above the damage waterline. This requirement does not apply to forepeak and afterpeak.

9.3.3.93-
9.3.3.99 (*Reserved*)

9.3.4 Alternative constructions

9.3.4.1 General

9.3.4.1.1 The maximum permissible capacity of a cargo tank in accordance with 9.3.1.11.1, 9.3.2.11.1 and 9.3.3.11.1 may be exceeded and the minimum distances in accordance with 9.3.1.11.2 a) and 9.3.2.11.7 may be deviated from provided that the provisions of this section are complied with. The capacity of a cargo tank shall not exceed 1000 m³.

9.3.4.1.2 Tank vessels whose cargo tanks exceed the maximum allowable capacity or where the distance between the side wall and the cargo tank is smaller than required, shall be protected through a more crashworthy side structure. This shall be proved by comparing the risk of a conventional construction (reference construction), complying with the ADN regulations with the risk of a crashworthy construction (alternative construction).

9.3.4.1.3 When the risk of the more crashworthy construction is equal to or lower than the risk of the conventional construction, equivalent or higher safety is proven. The equivalent or higher safety shall be proven in accordance with 9.3.4.3.

9.3.4.1.4 When a vessel is built in compliance with this section, a recognised classification society shall document the application of the calculation procedure in accordance with 9.3.4.3 and shall submit its conclusions to the competent authority for approval.

The competent authority may request additional calculations and proof.

9.3.4.1.5 The competent authority shall include this construction in the certificate of approval in accordance with 8.6.1.

9.3.4.2 Approach

9.3.4.2.1 The probability of cargo tank rupture due to a collision and the area around the vessel affected by the cargo outflow as a result thereof are the governing parameters. The risk is described by the following formula:

$$R = P \cdot C$$

Wherein: R risk [m²],

P probability of cargo tank rupture [],

C consequence (measure of damage) of cargo tank rupture [m²].

9.3.4.2.2 The probability P of cargo tank rupture depends on the probability distribution of the available collision energy represented by vessels, which the victim is likely to encounter in a collision, and the capability of the struck vessel to absorb collision energy without cargo tank rupture. A decrease of this probability can be achieved by means of a more crashworthy side structure.

The consequence C of cargo spillage resulting from cargo tank rupture is expressed as an affected area around the struck vessel.

9.3.4.2.3 The procedure according to 9.3.4.3 shows how tank rupture probabilities shall be calculated as well as how the collision energy absorbing capacity of side structure and a consequence increase shall be determined.

9.3.4.3 Calculation procedure

9.3.4.3.1 The calculation procedure shall follow 13 basic steps. Steps 2 through 10 shall be carried out for both the alternative design and the reference design. The following table shows the calculation of the weighted probability of cargo tank rupture:

9.3.4.3.1.1 *Step 1*

Besides the alternative design, which is used for cargo tanks exceeding the maximum allowable capacity or a reduced distance between the side wall and the cargo tank as well as a more crashworthy side structure, a reference design with at least the same dimensions (length, width, depth, displacement) shall be drawn up. This reference design shall fulfil the requirements specified in section 9.3.1 (Type G), 9.3.2 (Type C) or 9.3.3 (Type N) and shall comply with the minimum requirements of a recognised classification society.

9.3.4.3.1.2 *Step 2*

9.3.4.3.1.2.1 The relevant typical collision locations $i=1$ through n shall be determined. The table in 9.3.4.3.1 depicts the general case where there are 'n' typical collision locations.

The number of typical collision locations depends on the vessel design. The choice of the collision locations shall be accepted by the recognised classification society.

9.3.4.3.1.2.2 *Vertical collision locations*

9.3.4.3.1.2.2.1 *Tank vessel type C and N*

9.3.4.3.1.2.2.1.1 The determination of the collision locations in the vertical direction depends on the draught differences between striking and struck vessel, which is limited by the maximum and minimum draughts of both vessels and the construction of the struck vessel. This can be depicted graphically through a rectangular area which is enclosed by the values of the maximum and minimum draught of both striking and struck vessel (see following figure).

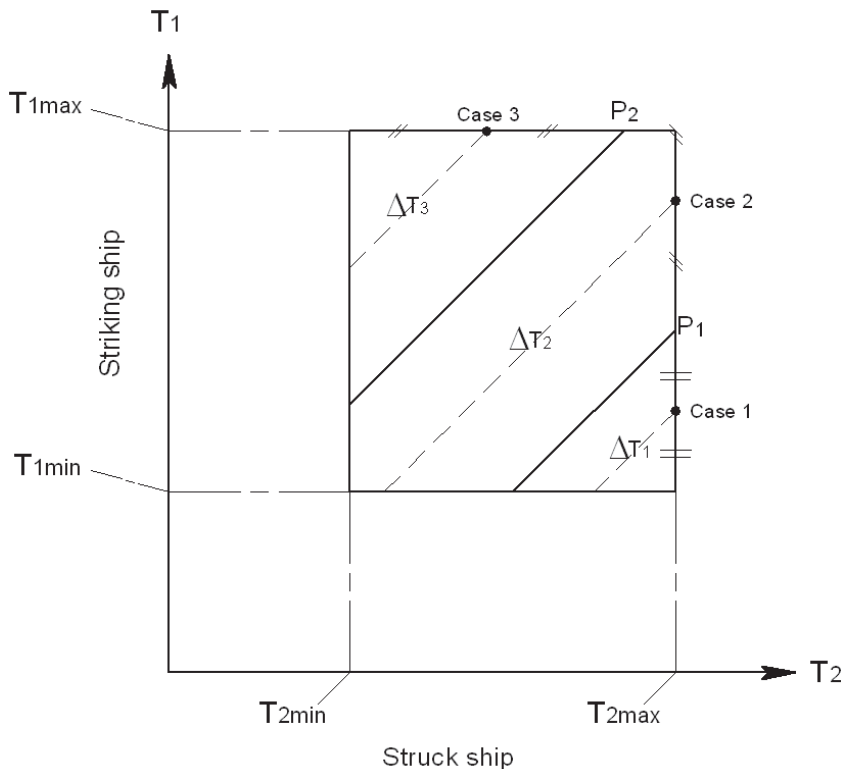

Definition of vertical striking locations

9.3.4.3.1.2.2.1.2 Each point in this area represents a possible draught combination. T_{1max} is the maximum draught and T_{1min} is the minimum draught of the striking vessel, while T_{2max} and T_{2min} are

the corresponding minimum and maximum draughts of the struck vessel. Each draught combination has an equal probability of occurrence.

9.3.4.3.1.2.2.1.3 Points on each inclined line in the figure in 9.3.4.3.1.2.2.1.1 indicate the same draught difference. Each of these lines reflects a vertical collision location. In the example in the figure in 9.3.4.3.1.2.2.1.1 three vertical collision locations are defined, depicted by three areas. Point P_1 is the point where the lower edge of the vertical part of the push barge or V-bow strikes at deck level of the struck vessel. The triangular area for collision case 1 is bordered by point P_1 . This corresponds to the vertical collision location “collision at deck level”. The triangular upper left area of the rectangle corresponds to the vertical collision location “collision below deck”. The draught difference ΔT_i , $i=1,2,3$ shall be used in the collision calculations (see following figure).

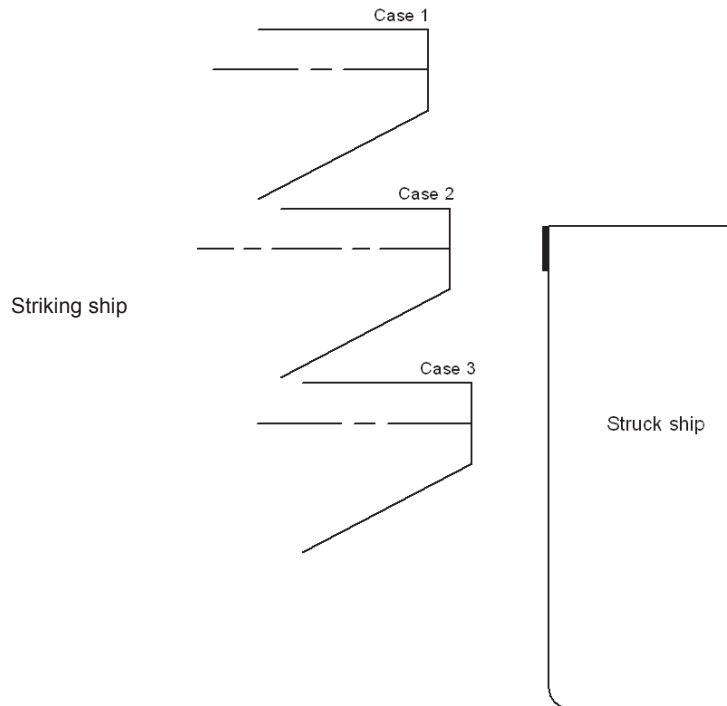

Example of vertical collision locations

9.3.4.3.1.2.2.1.4 For the calculation of the collision energies the maximum masses of both striking vessel and struck vessel must be used (highest point on each respective diagonal ΔT_i).

9.3.4.3.1.2.2.1.5 Depending on the vessel design, the recognised classification society may require additional collision locations.

9.3.4.3.1.2.2.2 *Tank vessel type G*

For a tank vessel type G a collision at half tank height shall be assumed. The recognised classification society may require additional collision locations at other heights. This shall be agreed with the recognised classification society.

9.3.4.3.1.2.3 *Longitudinal collision location*

9.3.4.3.1.2.3.1 *Tank vessels type C and N*

At least the following three typical collision locations shall be considered:

- at bulkhead,

- between webs and
- at web.

9.3.4.3.1.2.3.2 *Tank vessel type G*

For a tank vessel type G at least the following three typical collision locations shall be considered:

- at cargo tank end,
- between webs and
- at web.

9.3.4.3.1.2.4 *Number of collision locations*

9.3.4.3.1.2.4.1 *Tank vessel type C and N*

The combination of vertical and longitudinal collision locations in the example mentioned in 9.3.4.3.1.2.2.1.3 and 9.3.4.3.1.2.3.1 results in $3 \cdot 3 = 9$ collision locations.

9.3.4.3.1.2.4.2 *Tank vessel type G*

The combination of vertical and longitudinal collision locations in the example mentioned in 9.3.4.3.1.2.2.2 and 9.3.4.3.1.2.3.2 results in $1 \cdot 3 = 3$ collision locations.

9.3.4.3.1.2.4.3 *Additional examinations for tank vessels type G, C and N with independent cargo tanks*

As proof that the tank seatings and the buoyancy restraints do not cause any premature tank rupture, additional calculations shall be carried out. The additional collision locations for this purpose shall be agreed with the recognised classification society.

9.3.4.3.1.3 *Step 3*

9.3.4.3.1.3.1

For each typical collision location a weighting factor which indicates the relative probability that such a typical collision location will be struck shall be determined. In the table in 9.3.4.3.1 these factors are named $wf_{loc(i)}$ (column J). The assumptions shall be agreed with the recognised classification society.

The weighting factor for each collision location is the product of the factor for the vertical collision location by the factor for the longitudinal collision location.

9.3.4.3.1.3.2 *Vertical collision locations*

9.3.4.3.1.3.2.1 *Tank vessel type C and N*

The weighting factors for the various vertical collision locations are in each case defined by the ratio between the partial area for the corresponding collision case and the total area of the rectangle shown in the Figure in 9.3.4.3.1.2.2.1.1.

For example, for collision case 1 (see figure in 9.3.4.3.1.2.2.1.3) the weighting factor equals the ratio between the triangular lower right area of the rectangle, and the area of the rectangle between minimum and maximum draughts of striking and struck vessels.

9.3.4.3.1.3.2.2 *Tank vessel type G*

The weighting factor for the vertical collision location has the value 1.0, if only one collision location is assumed. When the recognised classification society requires additional collision locations, the weighting factor shall be determined analogous to the procedure for tank vessels type C and N.

9.3.4.3.1.3.3 *Longitudinal collision locations*

9.3.4.3.1.3.3.1 *Tank vessel type C and N*

The weighting factor for each longitudinal collision location is the ratio between the “calculational span length” and the tank length.

The calculational span length shall be calculated as follows:

(a) collision on bulkhead:

0.2 • distance between web frame and bulkhead, but not larger than 450 mm,

(b) collision on web frame:

sum of 0.2 • web frame spacing forward of the web frame, but not larger than 450 mm, and 0.2 • web frame spacing aft of the web frame, but not larger than 450 mm, and

(c) collision between web frames:

cargo tank length minus the length “collision at bulkhead” and minus the length “collision at web frame”.

9.3.4.3.1.3.3.2 *Tank vessel type G*

The weighting factor for each longitudinal collision location is the ratio between the “calculational span length” and the length of the hold space.

The calculational span length shall be calculated as follows:

(a) collision at cargo tank end:

distance between bulkhead and the start of the cylindrical part of the cargo tank,

(b) collision on web frame:

sum of 0.2 • web frame spacing forward of the web frame, but not larger than 450 mm, and 0.2 • web frame spacing aft of the web frame, but not larger than 450 mm, and

(c) collision between web frames:

cargo tank length minus the length “collision at cargo tank end” and minus the length “collision at web frame”.

9.3.4.3.1.4 *Step 4*

9.3.4.3.1.4.1 For each collision location the collision energy absorbing capacity shall be calculated. For that matter the collision energy absorbing capacity is the amount of collision energy absorbed by the vessel structure up to initial rupture of the cargo tank (see the table in 9.3.4.3.1, column D: $E_{loc(i)}$). For this purpose a finite element analysis in accordance with 9.3.4.4.2 shall be used.

9.3.4.3.1.4.2 These calculations shall be done for two collision scenarios according to the following table. Collision scenario I shall be analysed under the assumption of a push barge bow shape. Collision scenario II shall be analysed under the assumption of a V-shaped bow.

These bow shapes are defined in 9.3.4.4.8.

Table : Speed reduction factors for scenario I or scenario II with weighting factors

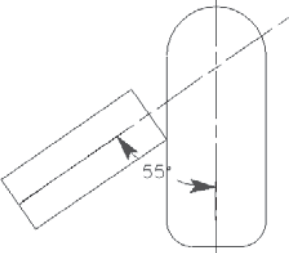
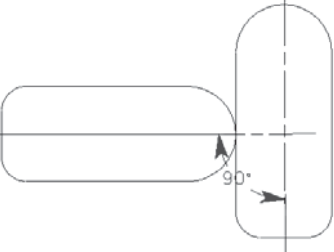
Worst case scenarios		Causes				
		Communication error and poor visibility	Technical error	Human error		
		0,50	0,20	0,30		
I		Push barge-bow, striking angle 55°	0,80	0,66	0,50	1,00
		V-shaped-bow, striking angle 90°	0,20	0,30		1,00

9.3.4.3.1.5 Step 5

9.3.4.3.1.5.1 For each collision energy absorption capacity $E_{loc(i)}$, the associated probability of exceedance is to be calculated, i.e. the probability of cargo tank rupture. For this purpose, the formula for the cumulative probability density functions (CPDF) below shall be used. The appropriate coefficients shall be selected from the Table in 9.3.4.3.1.5.6 for the effective mass of the struck vessel.

$$P_{x\%} = C_1(E_{loc(i)})^3 + C_2(E_{loc(i)})^2 + C_3E_{loc(i)} + C_4$$

with: $P_{x\%}$ probability of tank rupture,
 C_{1-4} coefficients from table in 9.3.4.3.1.5.6,
 $E_{loc(i)}$ collision energy absorbing capacity.

9.3.4.3.1.5.2 The effective mass shall be equal to the maximum displacement of the vessel multiplied by a factor of 1.4. Both collision scenarios (9.3.4.3.1.4.2) shall be considered.

9.3.4.3.1.5.3 In the case of collision scenario I (push barge bow at 55°), three CPDF formulas shall be used:

- CPDF 50% (velocity $0.5 V_{max}$),
- CPDF 66% (velocity $2/3 V_{max}$) and
- CPDF 100% (velocity V_{max}).

9.3.4.3.1.5.4 In the case of scenario II (V-shaped bow at 90°), the following two CPDF formulas shall be used:

CPDF 30% (velocity $0.3 V_{max}$) and
 CPDF 100% (velocity V_{max}).

9.3.4.3.1.5.5 In the table in 9.3.4.3.1, column F, these probabilities are called *P50%*, *P66%*, *P100%* and *P30%*, *P100%* respectively.

9.3.4.3.1.5.6 Table: Coefficients for the CPDF formulas

Effective mass of struck vessel in tonnes	velocity = $1 \times V_{max}$				range
	coefficients				
	C_1	C_2	C_3	C_4	
14000	4.106E-05	-2.507E-03	9.727E-03	9.983E-01	$4 < E_{loc} < 39$
12000	4.609E-05	-2.761E-03	1.215E-02	9.926E-01	$4 < E_{loc} < 36$
10000	5.327E-05	-3.125E-03	1.569E-02	9.839E-01	$4 < E_{loc} < 33$
8000	6.458E-05	-3.691E-03	2.108E-02	9.715E-01	$4 < E_{loc} < 31$
6000	7.902E-05	-4.431E-03	2.719E-02	9.590E-01	$4 < E_{loc} < 27$
4500	8.823E-05	-5.152E-03	3.285E-02	9.482E-01	$4 < E_{loc} < 24$
3000	2.144E-05	-4.607E-03	2.921E-02	9.555E-01	$2 < E_{loc} < 19$
1500	-2.071E-03	2.704E-02	-1.245E-01	1.169E+00	$2 < E_{loc} < 12$

Effective mass of struck vessel in tonnes	velocity = $0.66 \times V_{max}$				range
	coefficients				
	C_1	C_2	C_3	C_4	
14000	4.638E-04	-1.254E-02	2.041E-02	1.000E+00	$2 < E_{loc} < 17$
12000	5.377E-04	-1.427E-02	2.897E-02	9.908E-01	$2 < E_{loc} < 17$
10000	6.262E-04	-1.631E-02	3.849E-02	9.805E-01	$2 < E_{loc} < 15$
8000	7.363E-04	-1.861E-02	4.646E-02	9.729E-01	$2 < E_{loc} < 13$
6000	9.115E-04	-2.269E-02	6.285E-02	9.573E-01	$2 < E_{loc} < 12$
4500	1.071E-03	-2.705E-02	7.738E-02	9.455E-01	$1 < E_{loc} < 11$
3000	-1.709E-05	-1.952E-02	5.123E-02	9.682E-01	$1 < E_{loc} < 8$
1500	-2.479E-02	1.500E-01	-3.218E-01	1.204E+00	$1 < E_{loc} < 5$

Effective mass of struck vessel in tonnes	velocity = $0.5 \times V_{max}$				range
	coefficients				
	C_1	C_2	C_3	C_4	
14000	2.621E-03	-3.978E-02	3.363E-02	1.000E+00	$1 < E_{loc} < 10$
12000	2.947E-03	-4.404E-02	4.759E-02	9.932E-01	$1 < E_{loc} < 9$
10000	3.317E-03	-4.873E-02	5.843E-02	9.878E-01	$2 < E_{loc} < 8$
8000	3.963E-03	-5.723E-02	7.945E-02	9.739E-01	$2 < E_{loc} < 7$
6000	5.349E-03	-7.407E-02	1.186E-01	9.517E-01	$1 < E_{loc} < 6$
4500	6.303E-03	-8.713E-02	1.393E-01	9.440E-01	$1 < E_{loc} < 6$
3000	2.628E-03	-8.504E-02	1.447E-01	9.408E-01	$1 < E_{loc} < 5$
1500	-1.566E-01	5.419E-01	-6.348E-01	1.209E+00	$1 < E_{loc} < 3$

Effective mass of struck vessel in tonnes	velocity = 0.3 x V _{max}				
	coefficients				
	C ₁	C ₂	C ₃	C ₄	range
14000	5.628E-02	-3.081E-01	1.036E-01	9.991E-01	1<E _{loc} <3
12000	5.997E-02	-3.212E-01	1.029E-01	1.002E+00	1<E _{loc} <3
10000	7.477E-02	-3.949E-01	1.875E-01	9.816E-01	1<E _{loc} <3
8000	1.021E-02	-5.143E-01	2.983E-01	9.593E-01	1<E _{loc} <2
6000	9.145E-02	-4.814E-01	2.421E-01	9.694E-01	1<E _{loc} <2
4500	1.180E-01	-6.267E-01	3.542E-01	9.521E-01	1<E _{loc} <2
3000	7.902E-02	-7.546E-01	5.079E-01	9.218E-01	1<E _{loc} <2
1500	-1.031E+00	2.214E-01	1.891E-01	9.554E-01	0.5<E _{loc} <1

The range where the formula is valid is given in column 6. In case of an E_{loc} value below the range the probability equals P_{x%} = 1.0. In case of a value above the range P_{x%} equals 0.

9.3.4.3.1.6 Step 6

The weighted probabilities of cargo tank rupture P_{wx%} (table in 9.3.4.3.1, column H) shall be calculated by multiplying each cargo tank rupture probability P_{x%} (table in 9.3.4.3.1, column F) by the weighting factors wf_{x%} according to the following table:

Table: Weighting factors for each characteristic collision speed

			weighting factor
Scenario I	CPDF 50%	wf50%	0.2
	CPDF 66%	wf66%	0.5
	CPDF 100%	wf100%	0.3
Scenario II	CPDF 30%	wf30%	0.7
	CPDF 100%	wf100%	0.3

9.3.4.3.1.7 Step 7

The total probabilities of cargo tank rupture P_{loc(i)} (table in 9.3.4.3.1, column I) resulting from 9.3.4.3.1.6 (step 6) shall be calculated as the sum of all weighted cargo tank rupture probabilities P_{wx%} (table in 9.3.4.3.1, column H) for each collision location considered.

9.3.4.3.1.8 Step 8

For both collision scenarios the weighted total probabilities of cargo tank rupture P_{wloc(i)} shall, in each case, be calculated by multiplying the total tank probabilities of cargo tank rupture P_{loc(i)} for each collision location, by the weighting factors wf_{loc(i)} corresponding to the respective collision location (see 9.3.4.3.1.3 (step 3) and table in 9.3.4.3.1, column J).

9.3.4.3.1.9 Step 9

Through the addition of the weighted total probabilities of cargo tank rupture P_{wloc(i)}, the scenario specific total probabilities of cargo tank rupture P_{scenI} and P_{scenII} (table in 9.3.4.3.1, column L) shall be calculated, for each collision scenario I and II separately.

9.3.4.3.1.10 *Step 10*

Finally the weighted value of the overall total probability of cargo tank rupture P_w shall be calculated by the formula below (table in 9.3.4.3.1, column O):

$$P_w = 0.8 \cdot P_{scenI} + 0.2 \cdot P_{scenII}$$

9.3.4.3.1.11 *Step 11*

The overall total probability of cargo tank rupture P_w for the alternative design is called P_n . The overall total probability of cargo tank rupture P_w for the reference design is called P_r .

9.3.4.3.1.12 *Step 12*

9.3.4.3.1.12.1 The ratio (C_n/C_r) between the consequence (measure of damage) C_n of a cargo tank rupture of the alternative design and the consequence C_r of a cargo tank rupture of the reference design shall be determined with the following formula:

$$C_n/C_r = V_n / V_r$$

With C_n/C_r the ratio between the consequence related to the alternative design, and the consequence related to the reference design,

V_n maximum capacity of the largest cargo tank in the alternative design,

V_r maximum capacity of the largest cargo tank reference design.

9.3.4.3.1.12.2 This formula was derived for characteristic cargoes as listed in the following table.

Table: Characteristic cargoes

	UN No.	Description
Benzene	1114	Flammable liquid Packing group II Hazardous to health
Acrylonitrile Stabilised ACN	1093	Flammable liquid Packing group I Toxic, stabilised
n-Hexane	1208	Flammable liquid Packing group II
Nonane	1920	Flammable liquid Packing group III
Ammonia	1005	Toxic, corrosive gas Liquefied under pressure
Propane	1978	Flammable gas Liquefied under pressure

9.3.4.3.1.12.3 For cargo tanks with capacities between 380 m³ and 1000 m³ containing flammable, toxic and acid liquids or gases it shall be assumed that the effect increase relates linearly to the increased tank capacity (proportionality factor 1.0).

9.3.4.3.1.12.4 If substances are to be carried in tank vessels, which have been analysed according to this calculation procedure, where the proportionality factor between the total cargo tank capacity and the affected area is expected to be larger than 1.0, as assumed in the previous paragraph, the affected area shall be determined through a separate calculation. In this case the comparison as described in 9.3.4.3.1.13 (step 13) shall be carried out with this different value for the size of the affected area, t.

9.3.4.3.1.13 *Step 13*

Finally the ratio $\frac{P_r}{P_n}$ between the overall total probability of cargo tank rupture P_r for the reference design and the overall total probability of cargo tank rupture P_n for the alternative design shall be compared with the ratio $\frac{C_n}{C_r}$ between the consequence related to the alternative design, and the consequence related to the reference design.

When $\frac{C_n}{C_r} \leq \frac{P_r}{P_n}$ is fulfilled, the evidence according to 9.3.4.1.3 for the alternative design is provided.

9.3.4.4 *Determination of the collision energy absorbing capacity*

9.3.4.4.1 *General*

9.3.4.4.1.1 The determination of the collision energy absorbing capacity shall be carried out by means of a finite element analysis (FEA). The analysis shall be carried out using a customary finite element code (e.g. LS-DYNA², PAM-CRASH³, ABAQUS⁴ etc.) capable of dealing with both geometrical and material non-linear effects. The code shall also be able to simulate rupture realistically.

9.3.4.4.1.2 The program actually used and the level of detail of the calculations shall be agreed upon with a recognised classification society.

9.3.4.4.2 *Creating the finite element models (FE models)*

9.3.4.4.2.1 First of all, FE models for the more crashworthy design and one for the reference design shall be generated. Each FE model shall describe all plastic deformations relevant for all collision cases considered. The section of the cargo area to be modelled shall be agreed upon with a recognised classification society.

9.3.4.4.2.2 At both ends of the section to be modelled all three translational degrees of freedom are to be restrained. Because in most collision cases the global horizontal hull girder bending of the vessel is not of significant relevance for the evaluation of plastic deformation energy it is sufficient that only half beam of the vessel needs to be considered. In these cases the transverse displacements at the centre line (CL) shall be constrained. After generating the FE model, a trial collision calculation shall be carried out to ensure that there is no occurrence of plastic deformations near the constraint boundaries. Otherwise the FE modelled area has to be extended.

9.3.4.4.2.3 Structural areas affected during collisions shall be sufficiently finely idealized, while other parts may be modelled more coarsely. The fineness of the element mesh shall be suitable for an adequate description of local folding deformations and for determination of realistic rupture of elements.

² LSTC, 7374 Las Positas Rd, Livermore, CA 94551, USA Tel : +1 925 245-4500.

³ ESI Group, 8, Rue Christophe Colomb, 75008 Paris, France
Tel: +33 (0)1 53 65 14 14, Fax: +33 (0)1 53 65 14 12, E-mail: info@esi-group.com.

⁴ SIMULIA, Rising Sun Mills, 166 Valley Street, Providence, RI 02909-2499 USA
Tel: +1 401 276-4400, Fax: +1 401 276-4408, E-mail: info@simulia.com.

- 9.3.4.4.2.4 The calculation of rupture initiation must be based on fracture criteria which are suitable for the elements used. The maximum element size shall be less than 200 mm in the collision areas. The ratio between the longer and the shorter shell element edge shall not exceed the value of three. The element length L for a shell element is defined as the longer length of both sides of the element. The ratio between element length and element thickness shall be larger than five. Other values shall be agreed upon with the recognised classification society.
- 9.3.4.4.2.5 Plate structures, such as shell, inner hull (tank shell in the case of gas tanks), webs as well as stringers can be modelled as shell elements and stiffeners as beam elements. While modelling, cut outs and manholes in collision areas shall be taken into account.
- 9.3.4.4.2.6 In the FE calculation the 'node on segment penalty' method shall be used for the contact option. For this purpose the following options shall be activated in the codes mentioned:
- “contact_automatic_single_surface” in LS-DYNA,
 - “self impacting” in PAMCRASH, and
 - similar contact types in other FE-programs.

9.3.4.4.3 *Material properties*

- 9.3.4.4.3.1 Because of the extreme behaviour of material and structure during a collision, with both geometrical and material non-linear effects, true stress-strain relations shall be used:

$$\sigma = C \cdot \varepsilon^n,$$

where

$$n = \ln(1 + A_g),$$

$$C = R_m \cdot \left(\frac{e}{n}\right)^n,$$

A_g = the maximum uniform strain related to the ultimate tensile stress R_m and
 e = the natural logarithmic constant.

- 9.3.4.4.3.2 The values A_g and R_m shall be determined through tensile tests.
- 9.3.4.4.3.3 If only the ultimate tensile stress R_m is available, for shipbuilding steel with a yield stress R_{eH} of not more than 355 N/mm² the following approximation shall be used in order to obtain the A_g value from a known R_m [N/mm²] value:

$$A_g = \frac{1}{0.24 + 0.01395 \cdot R_m}$$

- 9.3.4.4.3.4 If the material properties from tensile tests are not available when starting the calculations, minimum values of A_g and R_m , as defined in the rules of the recognised classification society, shall be used instead. For shipbuilding steel with a yield stress higher than 355 N/mm² or materials other than shipbuilding steel, material properties shall be agreed upon with a recognised classification society.

9.3.4.4.4 *Rupture criteria*

9.3.4.4.4.1 The first rupture of an element in a FEA is defined by the failure strain value. If the calculated strain, such as plastic effective strain, principal strain or, for shell elements, the strain in the thickness direction of this element exceeds its defined failure strain value, the element shall be deleted from the FE model and the deformation energy in this element will no longer change in the following calculation steps.

9.3.4.4.4.2 The following formula shall be used for the calculation of rupture strain:

$$\varepsilon_f(l_e) = \varepsilon_g + \varepsilon_e \cdot \frac{t}{l_e}$$

where

ε_g = uniform strain

ε_e = necking

t = plate thickness

l_e = individual element length.

9.3.4.4.4.3 The values of uniform strain and the necking for shipbuilding steel with a yield stress R_{eH} of not more than 355 N/mm² shall be taken from the following table:

Table

stress states	1-D	2-D
ε_g	0.079	0.056
ε_e	0.76	0.54
element type	truss beam	shell plate

9.3.4.4.4.4 Other ε_g and ε_e values taken from thickness measurements of exemplary damage cases and experiments may be used in agreement with the recognised classification society.

9.3.4.4.4.5 Other rupture criteria may be accepted by the recognised classification society if proof from adequate tests is provided.

9.3.4.4.4.6 *Tank vessel type G*

For a tank vessel type G the rupture criterion for the pressure tank shall be based on equivalent plastic strain. The value to be used while applying the rupture criterion shall be agreed upon with the recognised classification society. Equivalent plastic strains associated with compressions shall be ignored.

9.3.4.4.5 *Calculation of the collision energy absorbing capacity*

9.3.4.4.5.1 The collision energy absorbing capacity is the summation of internal energy (energy associated with deformation of structural elements) and friction energy.

The friction coefficient μ_c is defined as:

$$\mu_c = FD + (FS - FD) \cdot e^{-DC|v_{rel}|}$$

with $FD = 0.1$,

$$\begin{aligned} \text{FS} &= 0.3, \\ \text{DC} &= 0.01 \\ |v_{rel}| &= \text{relative friction velocity.} \end{aligned}$$

NOTE: Values are default for shipbuilding steel.

9.3.4.4.5.2 The force penetration curves resulting from the FE model calculation shall be submitted to the recognised classification society.

9.3.4.4.5.3 *Tank vessel type G*

9.3.4.4.5.3.1 In order to obtain the total energy absorbing capacity of a tank vessel type G the energy absorbed through compression of the vapour during the collision shall be calculated.

9.3.4.4.5.3.2 The energy E absorbed by the vapour shall be calculated as follows:

$$E = \frac{p_1 \cdot V_1 - p_0 \cdot V_0}{1 - \gamma}$$

with:

$$\gamma = 1.4$$

(Note: The value 1.4 is the default value c_p/c_v with, in principle:

c_p = specific heat at constant pressure [J/(kgK)]

c_v = specific heat at constant volume [J/(kgK)]

p_0 = pressure at start of compression [Pa]

p_1 = pressure at end of compression [Pa]

V_0 = volume at start of compression [m³]

V_1 = volume at end of compression [m³]

9.3.4.4.6 *Definition of striking vessel and striking bow*

9.3.4.4.6.1 At least two types of bow shapes of the striking vessel shall be used for calculating the collision energy absorbing capacities:

- bow shape I: push barge bow (see 9.3.4.4.8),
- bow shape II: V-shape bow without bulb (see 9.3.4.4.8).

9.3.4.4.6.2 Because in most collision cases the bow of the striking vessel shows only slight deformations compared to the side structure of the struck vessel, a striking bow will be defined as rigid. Only for special situations, where the struck vessel has an extremely strong side structure compared to the striking bow and the structural behaviour of the struck vessel is influenced by the plastic deformation of the striking bow, the striking bow shall be considered as deformable. In this case the structure of the striking bow should also be modelled. This shall be agreed upon with the recognised classification society.

9.3.4.4.7 *Assumptions for collision cases*

For the collision cases the following shall be assumed:

- (a) As collision angle between striking and struck vessel 90° shall be taken in case of a V-shaped bow and 55° in case of a push barge bow; and
- (b) The struck vessel has zero speed, while the striking vessel runs into the side of the struck ship with a constant speed of 10 m/s.

The collision velocity of 10 m/s is an assumed value to be used in the FE analysis.

9.3.4.4.8 *Types of bow shapes*

9.3.4.4.8.1 Push barge bow

Characteristic dimensions shall be taken from the table below:

fr	half breadths		
	Knuckle 1	Knuckle 2	deck
145	4.173	5.730	5.730
146	4.100	5.730	5.730
147	4.028	5.730	5.730
148	3.955	5.711	5.711
149	3.883	5.653	5.653
150	3.810	5.555	5.555
151	3.738	5.415	5.415
152	3.665	5.230	5.230
transom	3.600	4.642	4.642

stem	heights		
	Knuckle 1	Knuckle 2	deck
0.769	1.773	2.882	5.084
0.993	2.022	3.074	5.116
1.255	2.289	3.266	5.149
1.559	2.576	3.449	5.181
1.932	2.883	3.621	5.214
2.435	3.212	3.797	5.246
3.043	3.536	3.987	5.278
3.652	3.939	4.185	5.315
4.200	4.300	4.351	5.340

The following figures are intended to provide illustration.

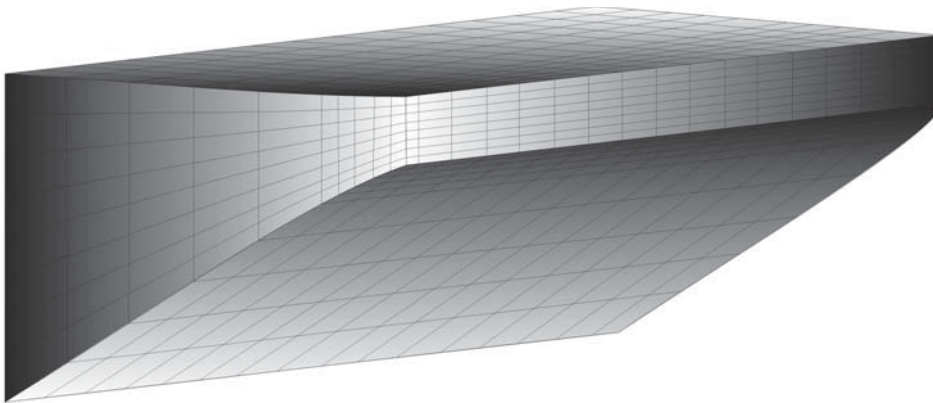

9.3.4.4.8.2 V-bow

Characteristic dimensions shall be taken from the table below:

Reference number	x	y	z
1	0.000	3.923	4.459
2	0.000	3.923	4.852
11	0.000	3.000	2.596
12	0.652	3.000	3.507
13	1.296	3.000	4.535
14	1.296	3.000	4.910
21	0.000	2.000	0.947
22	1.197	2.000	2.498
23	2.346	2.000	4.589
24	2.346	2.000	4.955
31	0.000	1.000	0.085
32	0.420	1.000	0.255
33	0.777	1.000	0.509
34	1.894	1.000	1.997
35	3.123	1.000	4.624
36	3.123	1.000	4.986
41	1.765	0.053	0.424
42	2.131	0.120	1.005
43	2.471	0.272	1.997
44	2.618	0.357	2.493
45	2.895	0.588	3.503
46	3.159	0.949	4.629
47	3.159	0.949	4.991
51	0.000	0.000	0.000
52	0.795	0.000	0.000
53	2.212	0.000	1.005
54	3.481	0.000	4.651
55	3.485	0.000	5.004

The following figures are intended to provide illustration.

