

# GTB Proposals to amend Regulations Nos. 7 and 48 to introduce Interdependent Lamp Systems

(ECE/TRANS/WP.29/GRE/2009/62 and ECE/TRANS/WP.29/GRE/2009/63Rev1)

## Additional Explanation

(to complement the justification included with the GTB proposals)

***Revised 03 December 2009***

***to coincide with the submission of an improved version of GRE/2009/63 by GTB***

# **Proposal for Interdependent Lamp System consisting of two or three Interdependent Lamps**

- New Lamp Category
- Characteristics differ from those of “D” Lamps. The complete system is type approved as a “single lamp” with a single applicant
- Up to three separate interdependent lamps assembled and type approved together as a “single lamp”
- May be mounted on fixed or moving components
- All light sources are switched on and off simultaneously.
- Photometric and geometric visibility requirements may be satisfied by one, or a combination of two or three of the interdependent lamps as specified by the applicant.
- Some of the interdependent lamps may not meet any photometric or geometric visibility requirement when operated alone but may be operated to provide an improved visual signal or improved appearance of the complete interdependent lamp system when installed on the vehicle
- Existing safety provisions of Regulations 7 and 48 are maintained.

**A summary of the possible installations related to the proposed provisions to be introduced into Regulations 7 and 48 is shown in the following charts:**

# Summary of Main Provisions introduced for Interdependent Lamps

## Reference Documents:

GRE/2009/62 (Regulation 07)

GRE/2009/63Rev1 (Regulation 48)

## ALL Interdependent Lamps (“Y” Lamps) Mounted on the Fixed Component

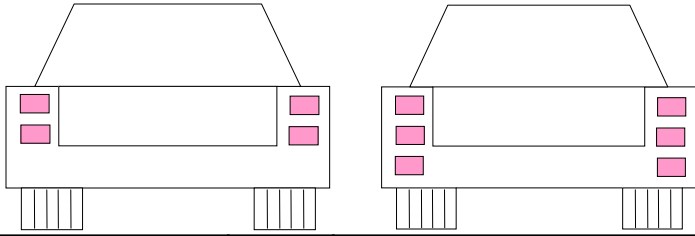

- All Interdependent lamps operate together and are type approved as a “single lamp” (New Paragraph 2.7.30)
- No issues associated with lamps on movable components
- All existing requirements in R48 and R07 apply

Position	R48	Existing requirements unchanged
Photometry	R07	Existing requirements unchanged
Geometric Visibility	R48	Para 2.13 Revised to only contain definitions. Requirements moved to a new paragraph 5.28 Para.5.28 (In the case of an interdependent lamp system, the above requirements shall be fulfilled when all its Interdependent lamps are operated together.) Para5.18 (Revised ) Para5.21 (existing)
Failure Provisions	R07	Para 6.1 (a) all light sources which are connected in series are considered to be one light source; (b) the lamp shall comply with the minimum intensity required when any one light source has failed. However, for lamps designed for only two light sources, 50 per cent of the minimum intensity in the axis of reference of the lamp shall be considered sufficient, provided that a note in the communication form states that the lamp is only for use on a vehicle fitted with an operating tell-tale which indicates when any one of these two light sources has failed;
Single Lamp Definitions and Requirements	R48	Para 2.16.1.d added to ensure that the distance between adjacent apparent surfaces does not exceed 75 mm when measured perpendicularly to the reference axis. This replaces the existing provisions with a more stringent requirement that is achievable with an interdependent lamp system to provide an improved lit appearance. Para. 5.7.2.2 amended Para 5.18 amended
Electrical Connections	R48 R07	Para 2.7.30.1 (New definition) Para 5.11.2 amended Para 6.5.7 amended Para 5.9 added

## ALL Interdependent Lamps (“Y” Lamps) Mounted on Moving Component(s)

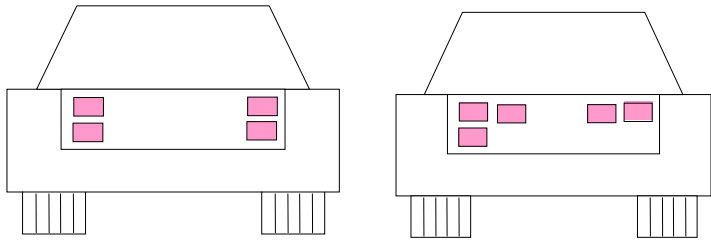

- All Interdependent lamps operate together and are type approved as a “single lamp” (New Paragraph 2.7.30)
- All existing requirements in R48 and R07 apply including special provisions for lamps mounted on movable components

Position	R48	Existing requirements unchanged
Photometry	R07	Existing requirements unchanged
Geometric Visibility	R48	<p>Para 2.13 Revised to only contain definitions. Requirements moved to a new paragraph 5.28</p> <p>Para.5.28 (In the case of an interdependent lamp system, the above requirements shall be fulfilled when all its Interdependent lamps are operated together.)</p> <p>Para5.18 (Revised ) and 5.18.4 (a) added to assure adequate geometric visibility is maintained when the moving component is in its fixed open position.</p> <p>Para5.21 (existing)</p>
Failure Provisions	R07	<p>Para 6.1</p> <p>(a) all light sources which are connected in series are considered to be one light source;</p> <p>(b) the lamp shall comply with the minimum intensity required when any one light source has failed. However, for lamps designed for only two light sources, 50 per cent of the minimum intensity in the axis of reference of the lamp shall be considered sufficient, provided that a note in the communication form states that the lamp is only for use on a vehicle fitted with an operating tell-tale which indicates when any one of these two light sources has failed;</p>
Single Lamp Definitions and Requirements	R48	<p>Para 2.16.1.d added to ensure that the distance between adjacent apparent surfaces does not exceed 75 mm when measured perpendicularly to the reference axis. This replaces the existing provisions with a more stringent requirement that is achievable with an interdependent lamp system to provide an improved lit appearance.</p> <p>Para. 5.7.2.2 amended</p> <p>Para 5.18 amended</p>
Electrical Connections	R48 R07	<p>Para 2.7.30.1 (New definition)</p> <p>Para 5.11.2 amended</p> <p>Para 6.5.7 amended</p> <p>Para 5.9 added</p>

# Interdependent Lamps (“Y” Lamps) Mounted on Fixed and Moving Component(s)

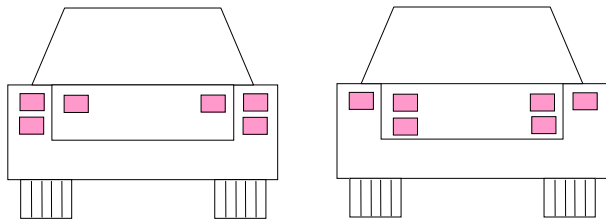

- All Interdependent lamps operate together and are type approved as a “single lamp” (New Paragraph 2.7.30)
- All existing requirements in R48 and R07 apply including special provisions for lamps mounted on movable components
- The Applicant shall specify the interdependent lamp or the combination of interdependent lamps that fulfil the photometric requirements. The Geometric Visibility requirements are fulfilled when all interdependent lamps are operated together and the moving parts are in their fixed closed position. When the moving parts are in their fixed open position the geometric visibility is assured within the angles defined by the photometric test points according to the provisions of new Para.5.18.4.

Position	R48	Existing requirements unchanged
Photometry	R07	Existing requirements unchanged
Geometric Visibility	R48	<p>Para 2.13 Revised to only contain definitions. Requirements moved to a new paragraph 5.28</p> <p>Para.5.28 (In the case of an interdependent lamp system, the above requirements shall be fulfilled when all its Interdependent lamps are operated together.)</p> <p>Para5.18 (Revised ) and 5.18.4 (b) added to assure adequate geometric visibility is maintained when the moving component is in its fixed open position.<b>(5.18.4(b): “The inboard geometric visibility requirement is deemed to be satisfied if this(these) interdependent lamp(s) still conform(s) to the photometric values prescribed in the field of light distribution for the approval of the device, at all fixed positions of the movable component(s).”</b>)</p> <p>Para5.21 (existing)</p>
Failure Provisions	R07	<p>Para 6.1</p> <p>(a) all light sources which are connected in series are considered to be one light source;</p> <p>(b) the lamp shall comply with the minimum intensity required when any one light source has failed. However, for lamps designed for only two light sources, 50 per cent of the minimum intensity in the axis of reference of the lamp shall be considered sufficient, provided that a note in the communication form states that the lamp is only for use on a vehicle fitted with an operating tell-tale which indicates when any one of these two light sources has failed;</p>
Single Lamp Definitions and Requirements	R48	<p>Para 2.16.1.d added to ensure that the distance between adjacent apparent surfaces does not exceed 75 mm when measured perpendicularly to the reference axis. This replaces the existing provisions with a more stringent requirement that is achievable with an interdependent lamp system to provide an improved lit appearance.</p> <p>Para. 5.7.2.2 amended</p> <p>Para 5.18 amended</p>
Electrical Connections	R48  R07	<p>Para 2.7.30.1 (New definition)</p> <p>Para 5.11.4 amended</p> <p>Para 6.5.7 amended</p> <p>Para 5.9 added</p>

# Supporting Rationale

# Changing Requirements Influencing Rear Signal lamp Design

Style is an important factor for vehicle sales and competitiveness

Good lit appearance by increasing lamp size and larger illuminated areas leads to increased safety

Vehicle owners require a wide rear door or trunk entrance. Leads to less space to mount lamps on the fixed part of the vehicle.

CO2 reduction objectives. Aerodynamics for Fuel efficiency lead to greater rear-end curvature



Please note: These images are for illustration purposes only and do not relate to specific installations



# Wide Tail-gate or Trunk Opening – Implications and Solutions

## Narrow lamp mounted on fender

“Wrap-around” curvature makes it difficult to achieve 45° inboard geometric visibility

Inboard Geometric Visibility assured to 20° due to the requirement to comply with the photometric grid



**Tail gate or Trunk in open position**

---

## Additional lamp mounted on the tail-gate or trunk lid

Provides 45° inboard geometric visibility

Provides enlarged illuminated area and improved appearance when operated in conjunction with the fender mounted lamp.



**Tail gate or Trunk in closed position**

**Please note: These images are for illustration purposes only and do not relate to specific installations**

# Provisions to Assure Adequate Geometric Visibility when the Moving Component is in its Fixed Open Position

## Introduction of Paragraph 5.18.4

"5.18.4 In the case where the functions referred to in paragraph 5.18 are obtained by an interdependent lamp system either of the following conditions shall apply:

Should the complete interdependent lamp system be mounted on the moving component(s), the requirements of paragraph 5.18.1 shall be satisfied. However, additional lamps for the above functions may be activated, when the movable component is in any fixed open position, provided that these additional independent lamps satisfy all the position, geometric visibility and photometric requirements applicable to the lamps installed on the movable component.

or

b) Should the interdependent lamp system be partly mounted on the fixed component and partly mounted on a movable component, the interdependent lamp(s) specified by the Applicant during the lamp approval procedure shall meet all the position, outboard geometric visibility and photometric requirements for those lamps, at all fixed positions of the movable component(s). The inboard geometric visibility requirement is deemed to be satisfied if this(these) interdependent lamp(s) still conform(s) to the photometric values prescribed in the field of light distribution for the approval of the device, at all fixed positions of the movable component(s)."

*From the technical and safety point of view, these changes mean that the interdependent lamp indicated by the manufacturer will guarantee the outboard geometric visibility up to the prescribed value (for example 80° for position lamps) and the inboard geometric visibility up to at least 20° (limit of the photometric grid). The difference in the perception distance between the required (for position lamps) 45° and the 20° provided by the photometric grid is around 1.6 m for a vehicle of normal width ( See the explanation on the next page). This difference of 1.6 metres is not detrimental for safety.*

*To satisfy the inboard geometric visibility requirements, currently specified in Reg. 48, the lamp shall fulfil the photometric values prescribed for the field outside the photometric grid and up to the limits of the geometric visibility field. This is what certain technical solutions (already on the market) are not able to fulfil without the complement of a second lamp normally not able to comply with the whole photometry requirements. The interdependent lamps are introduced mainly for this reason.*

# Wide Tail-gate or Trunk Opening – Geometric Visibility Implications



**Tail gate or Trunk in normal closed position**

All interdependent lamps satisfy the photometric requirements. Geometric visibility assured to 45° inboard



**Tail gate or Trunk in fixed open position**

The interdependent lamp mounted on the fixed component satisfies photometric requirements. Geometric visibility assured within the photometric grid (20° inboard)

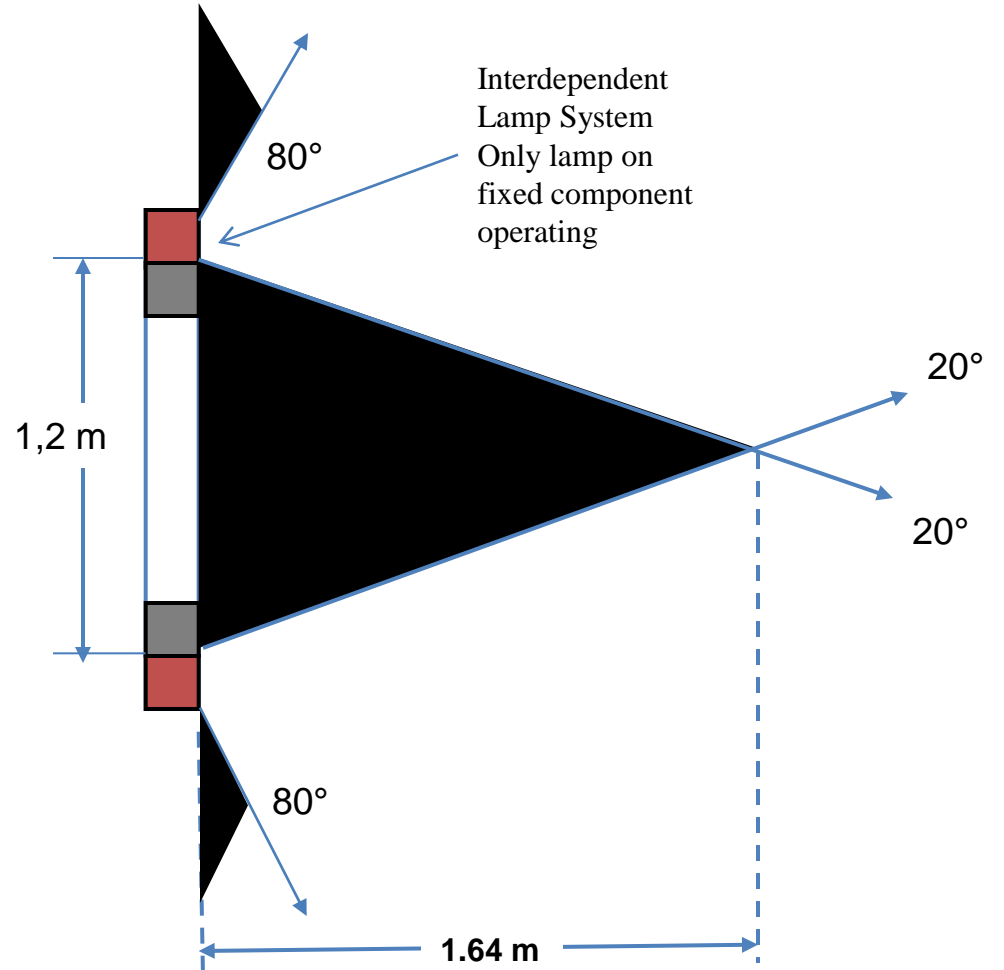
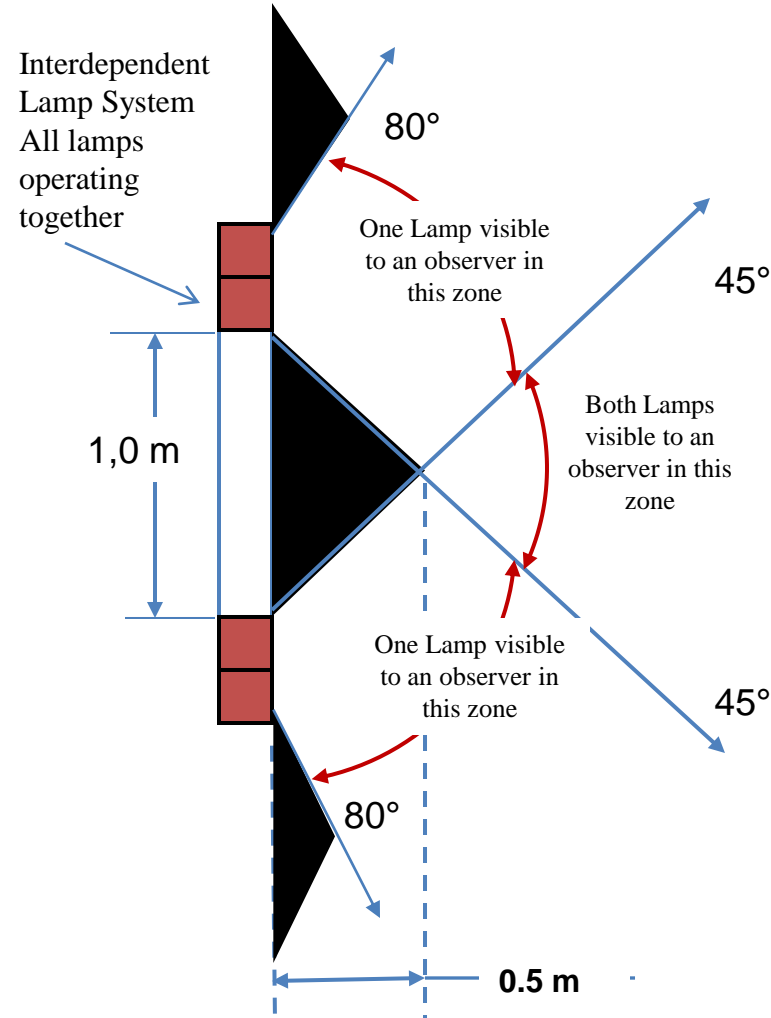

Please note: These images are for illustration purposes only and do not relate to specific installations

# Decision to Specify Maximum Separation of the Apparent Surfaces

A study commissioned for the AFS Eureka project 1403<sup>\*/</sup> concluded that 2 lamps having a separation of 150 mm are still close enough to be interpreted as one signal.

The 75mm maximum separation has been chosen to ensure a good lit appearance taking into account the two methods allowed to determine the apparent surface in Regulation 48 paragraph 2.10.

The effect of the 75mm separation limit is shown on the following diagram.

<sup>\*/</sup> *Soardo, Rossi, Iacomussi, Recognition distance and appearance, IENGF, Milano, 1999*

# Insertion of Paragraph 2.16.1(d) into Regulation 48

Provisions in Regulation 48, paragraph 2.16.1(b) relate to the special conditions applicable to “D” Lamps and provide for the installation of two independent lamps.

“D” lamps are

- not necessarily identical
- may be individually type approved
- may be produced by different manufacturers.

Provisions have been introduced into Regulation 48, paragraph 2.16.1(d) for the installation of an interdependent lamp system comprising of two or three interdependent lamps providing the same function.

Interdependent Lamps “Y Lamps” are:

- specifically designed and produced by one manufacturer
- effectively one continuous (single) lamp divided into two or three parts to facilitate installation onto the vehicle.
- capable of providing improved signalling and visual appearance by controlling, more precisely, the separation of the apparent surfaces.

For these reasons, instead of allowing the use of the “60% rule” a maximum separation of 75mm between adjacent apparent surfaces is prescribed.

# Distance Between Adjacent Apparent Surfaces

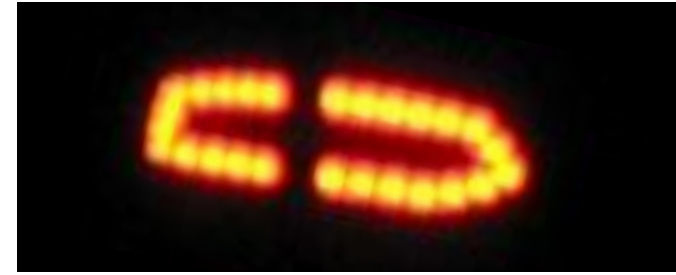

Edges of adjacent  
apparent surfaces

Although the two lamps are installed with a minimum  
gap the apparent surfaces are separated due to the  
physical limitations of the lamp construction

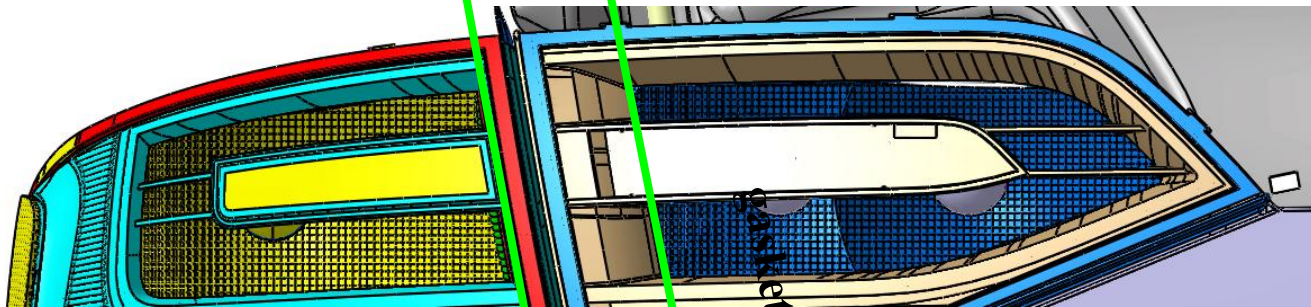

Vehicle bodywork and sealing  
gaskets prevent light emitting  
surfaces in this zone

75mm Maximum Proposed

$S_a 1$  = Apparent surface of lamp 1  
 $S_a 2$  = Apparent surface of lamp 2  
 $Q$  = smallest circumscribing quadrilateral

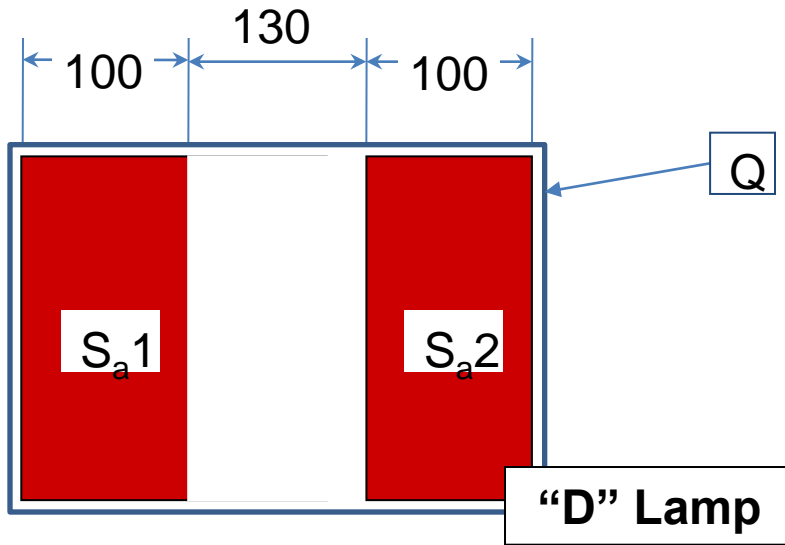

## Effect of the Proposed Para. 2.16.1(d)

A Comparison of the effects of the "60%" Rule and the 75mm Separation

Para. 2.16.1(b)

"the projection of their apparent surfaces in the direction of the reference axis occupies not less than 60 per cent of the smallest quadrilateral circumscribing the projections of the said apparent surfaces in the direction of the reference axis"

$$\text{i.e. } \frac{S_1 + S_2}{Q} \geq 60\%$$

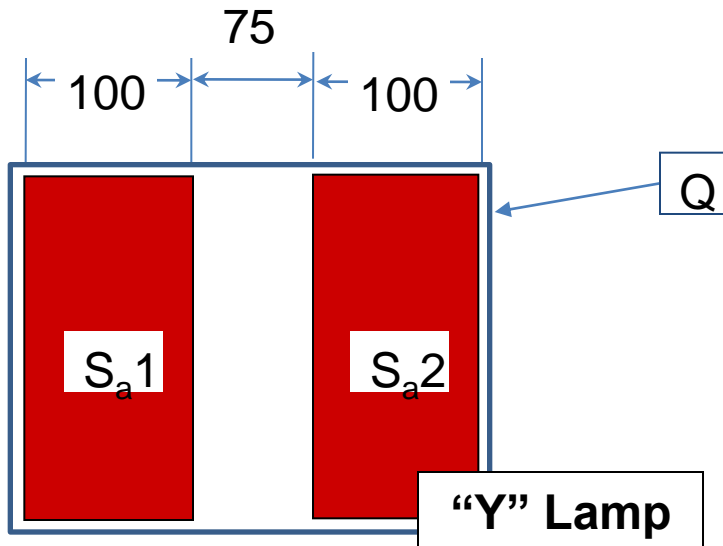

Para. 2.16.1(d)

"Any interdependent lamps ("Y" Lamps) in an interdependent lamp system having the same function, approved together as type "Y" and installed so that the distance between adjacent apparent surfaces does not exceed 75 mm when measured perpendicularly to the reference axis"