

Distr.: Restricted
9 February 2012

English only

Working Party on Inland Water Transport

**Working Party on the Standardization of Technical
and Safety Requirements in Inland Navigation**

Fortieth session

Geneva, 15–17 February 2012

Item 8 of the provisional agenda

Resolution No. 59, “Guidelines for Waterway Signs and Markings”

Appendix 1

**Sketches with minimal dimensions of the signs from
Annex 7 and 8 of the CEVNI**

Submitted by Sava Commission

CEVNI Annex 7

A.1

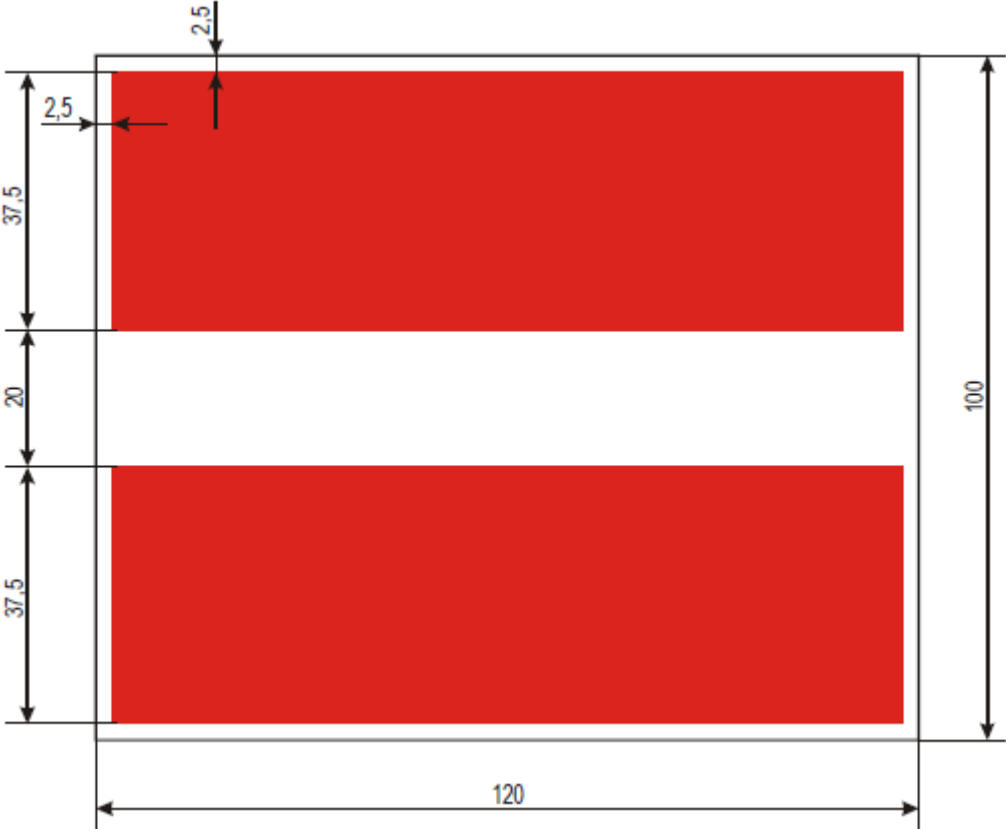

A.2

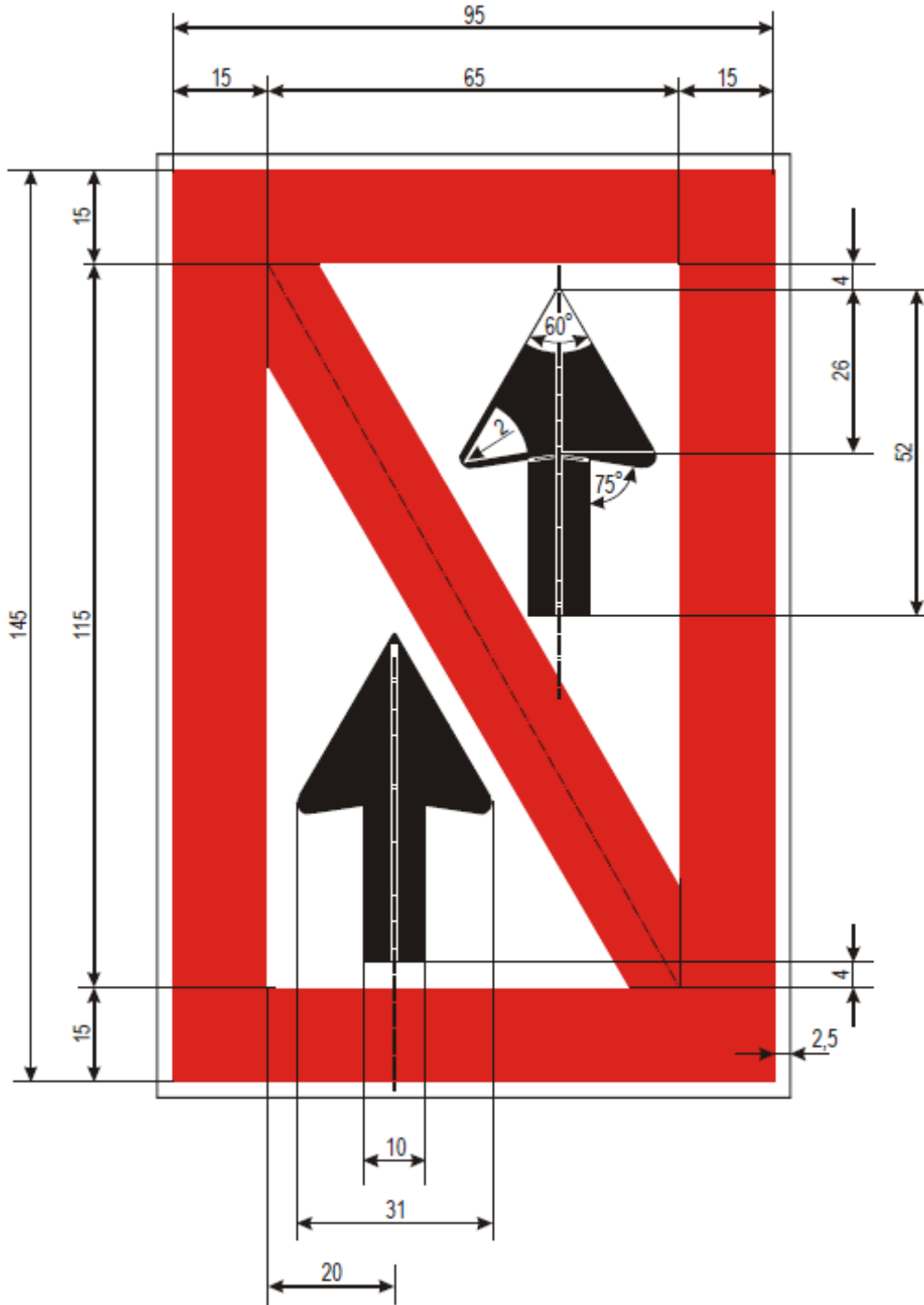

A.3

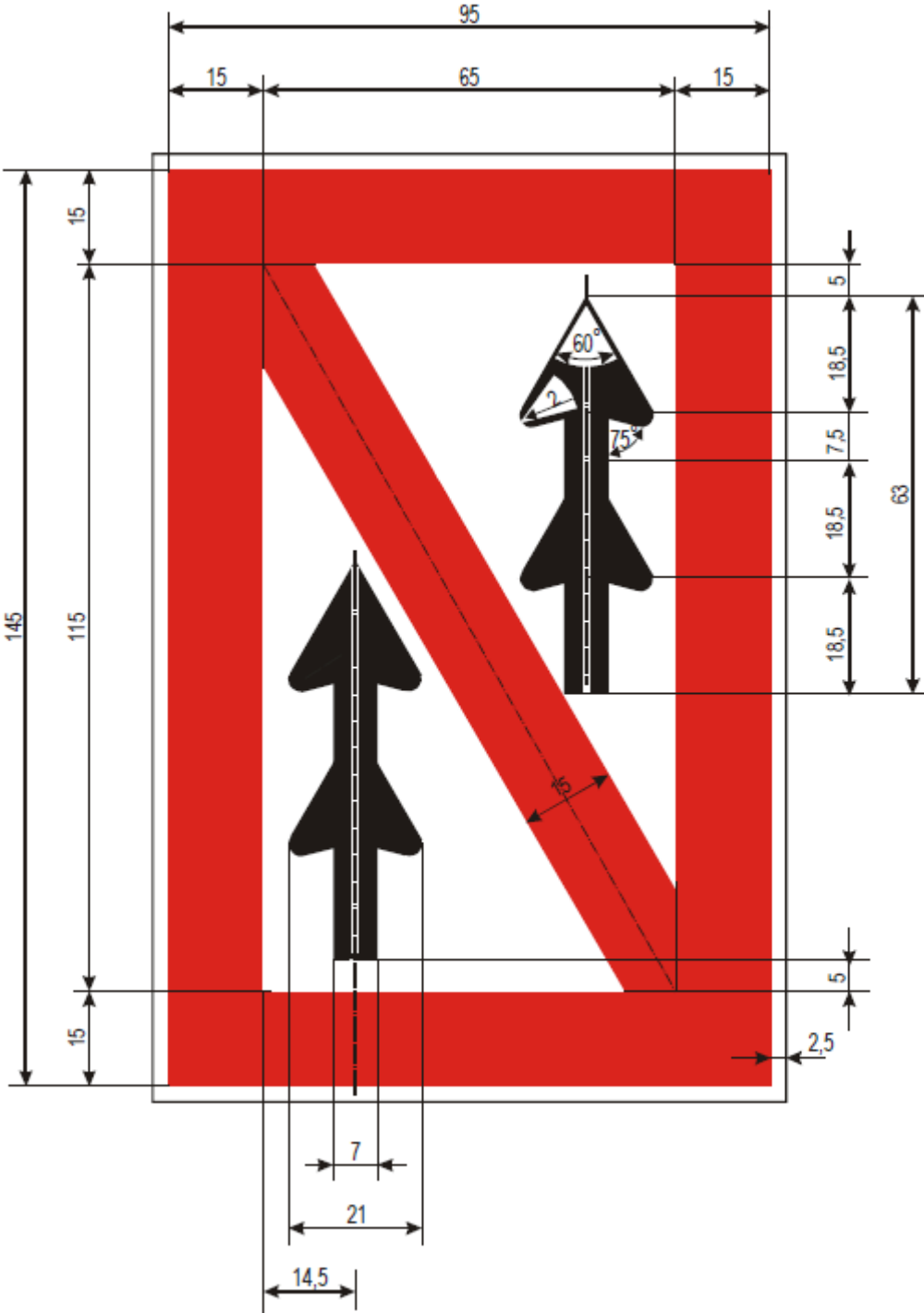

A.4

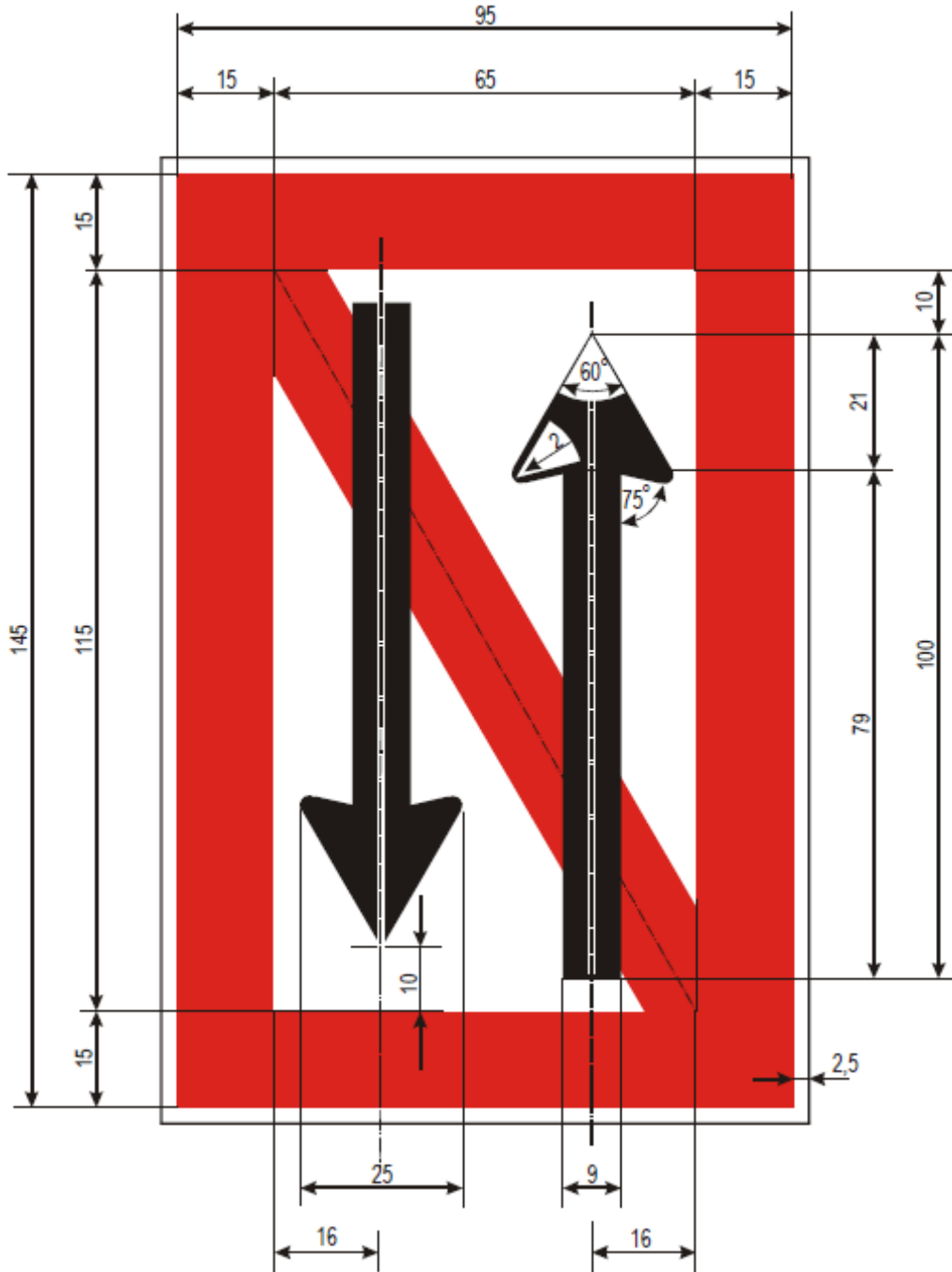

A.4.1

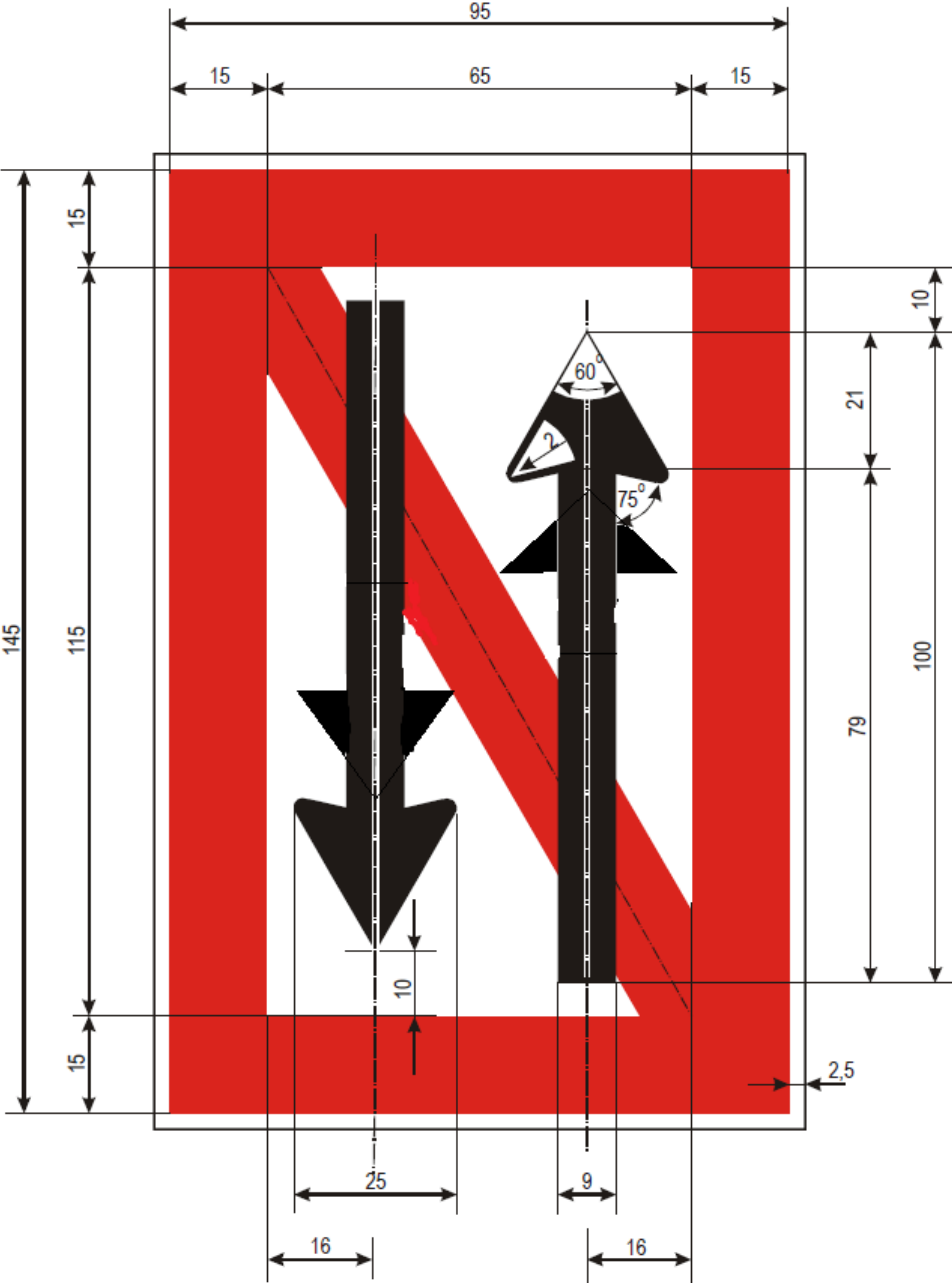

A.5

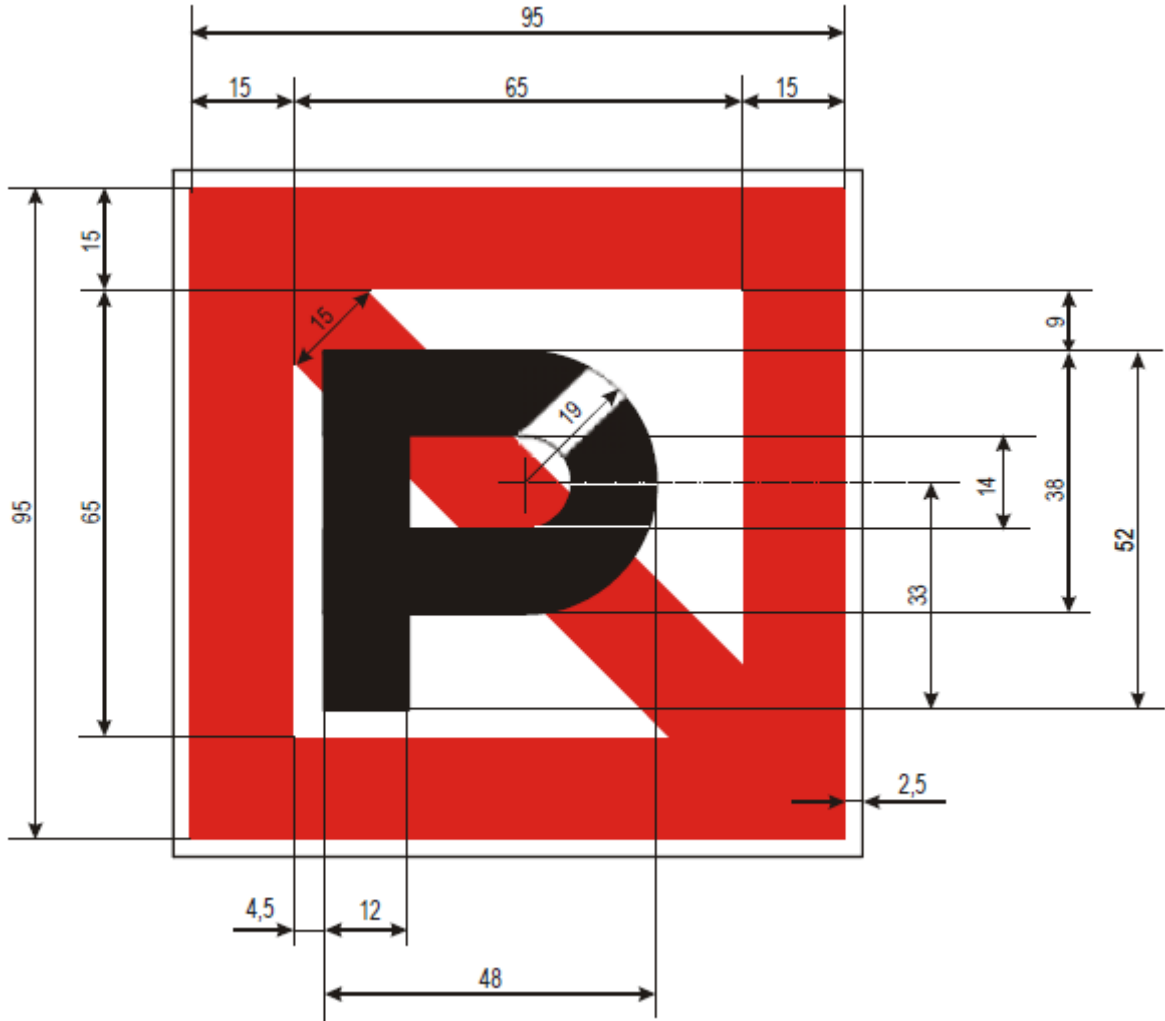

A.5.1

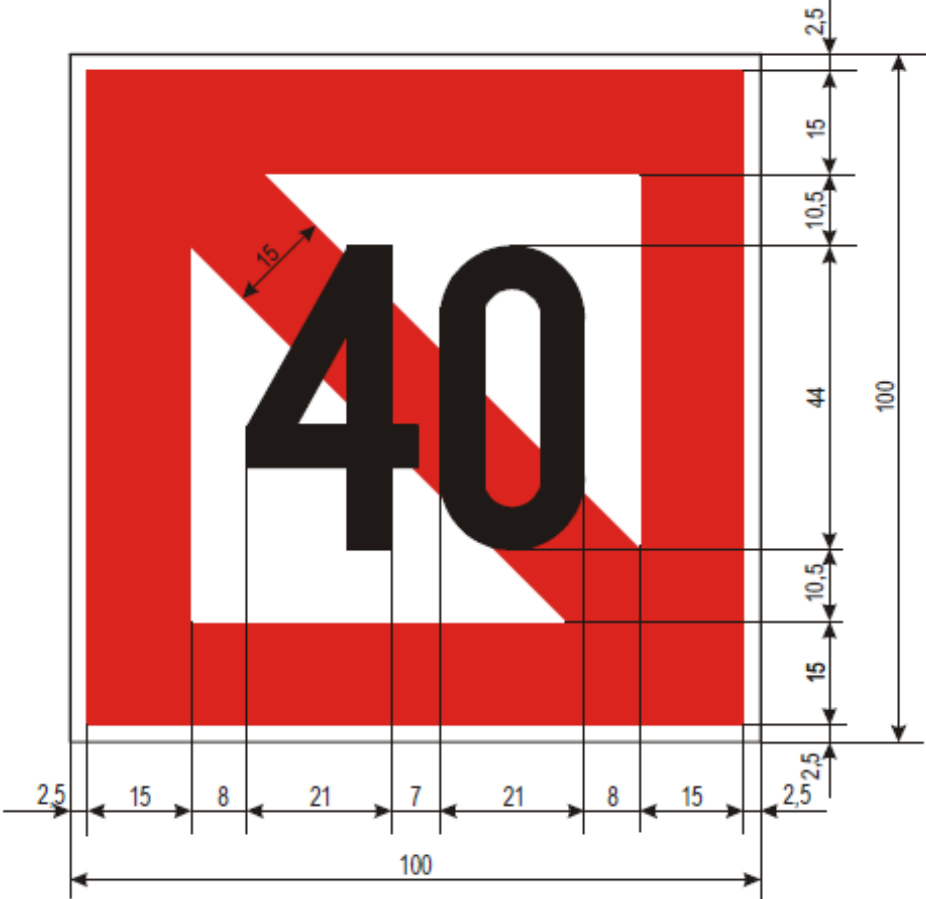

A.6

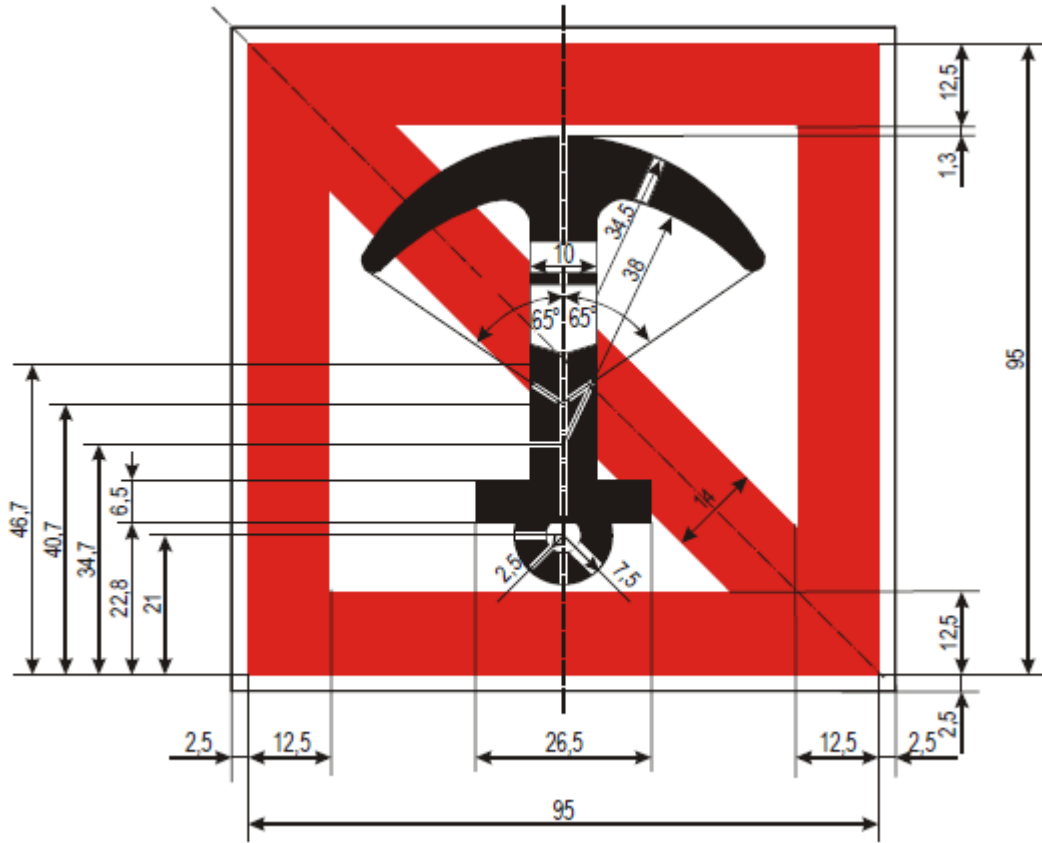

A.8

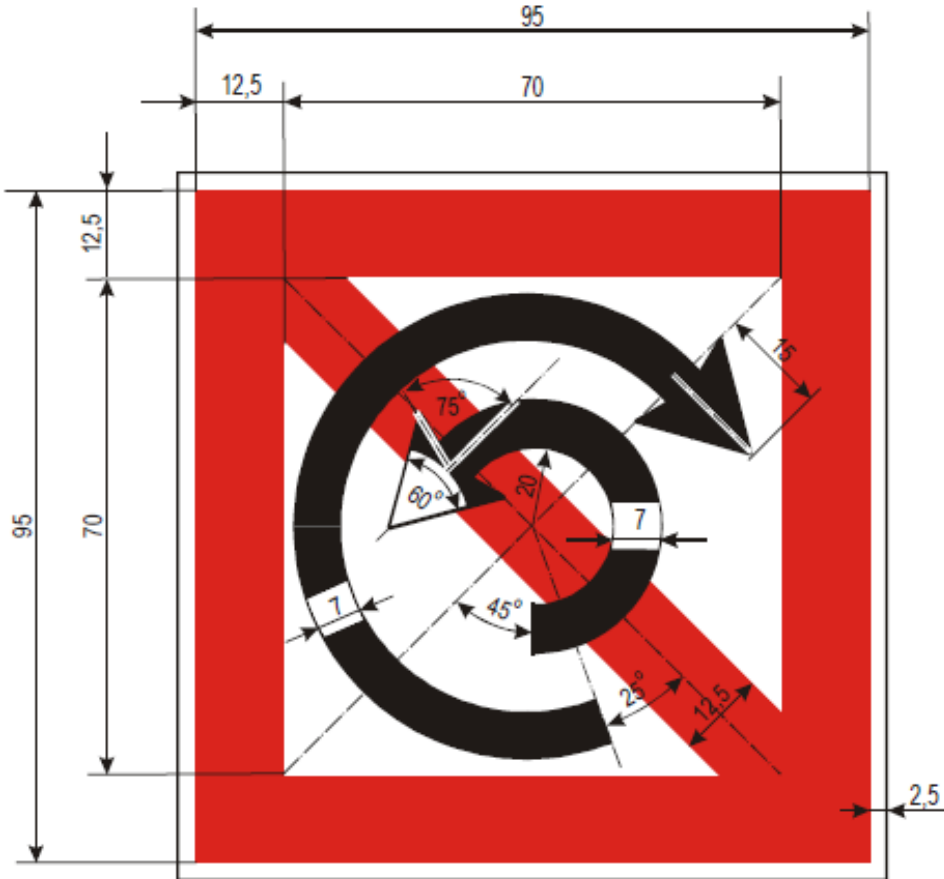

A.10

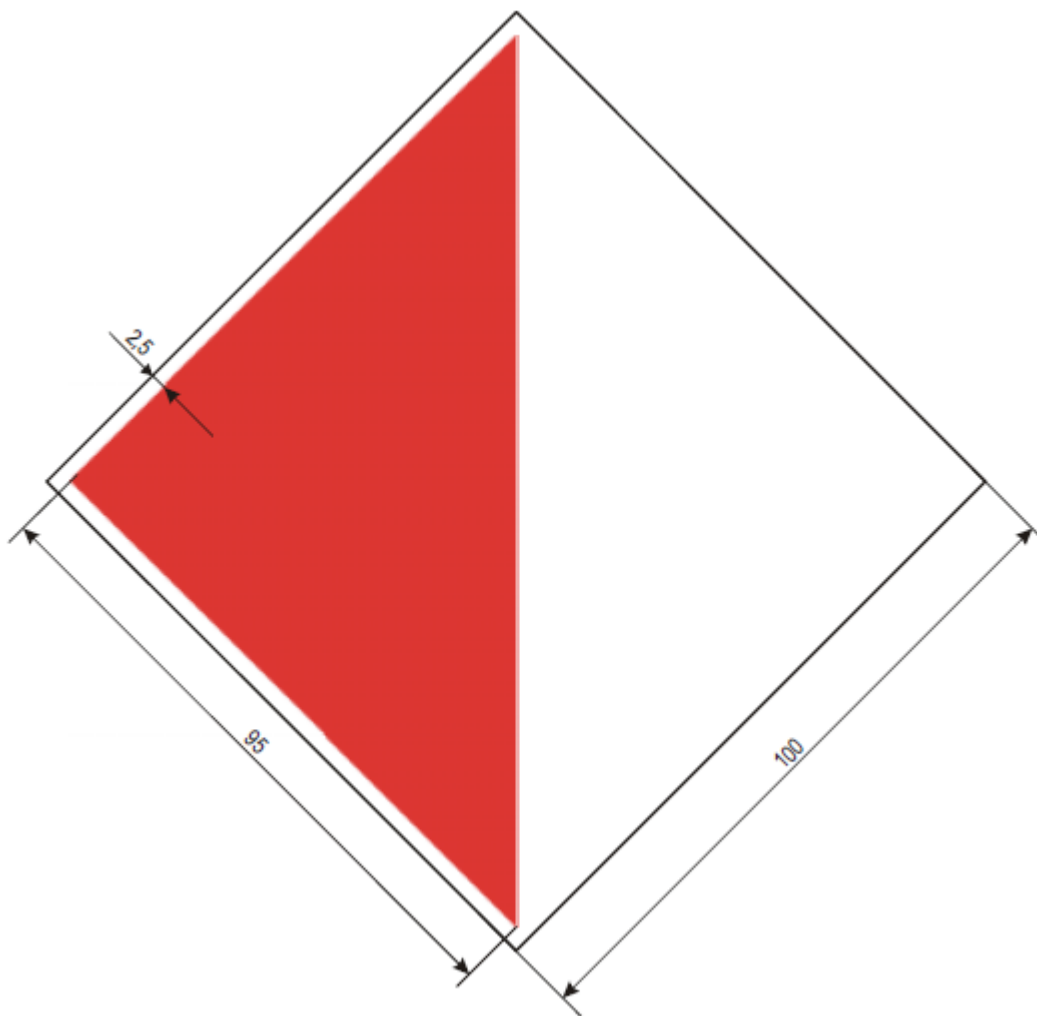

A.13

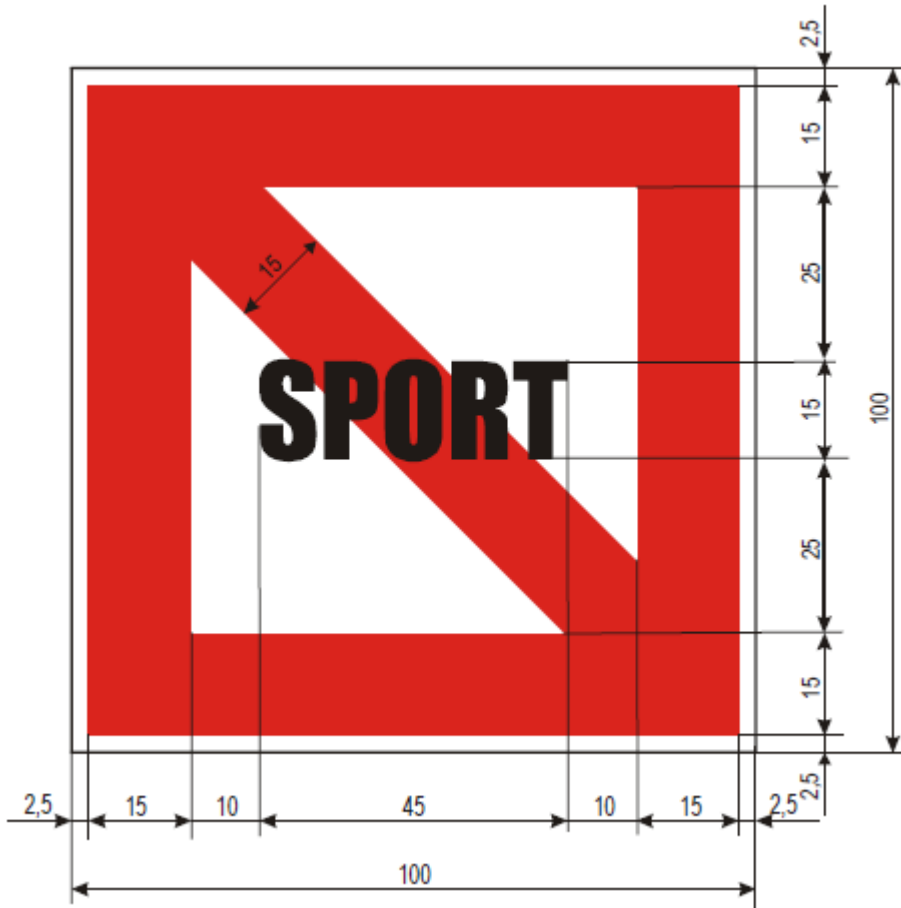

A.14

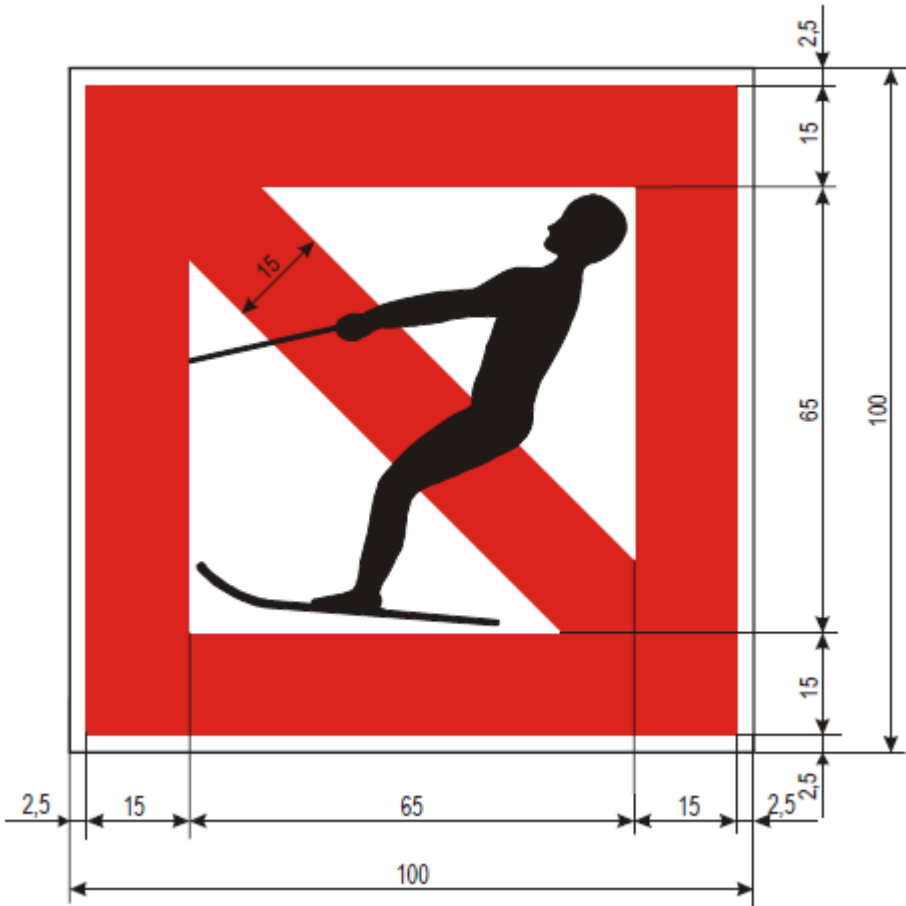

A.15

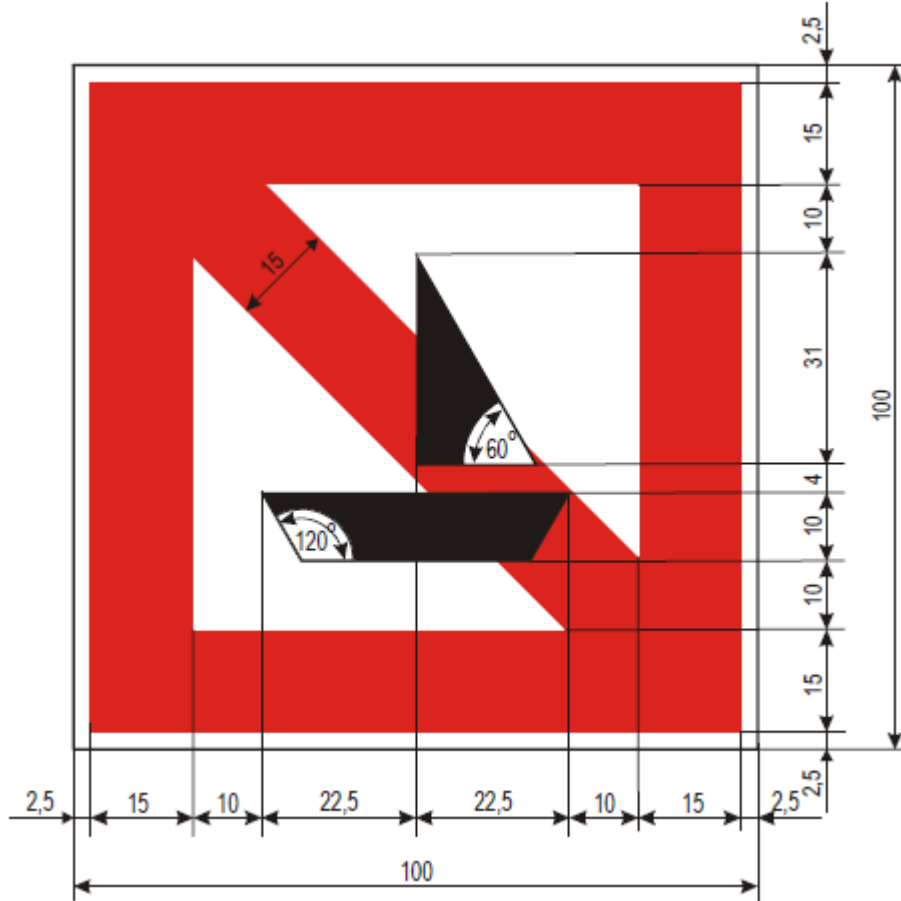

A.16

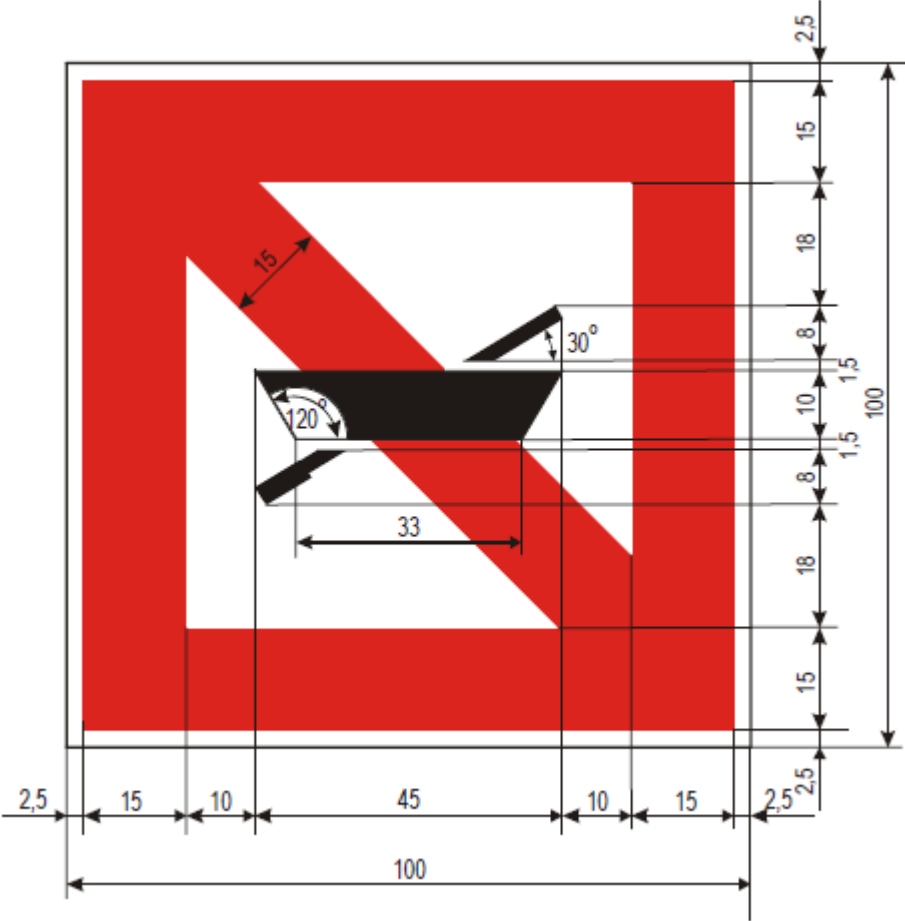

A.17

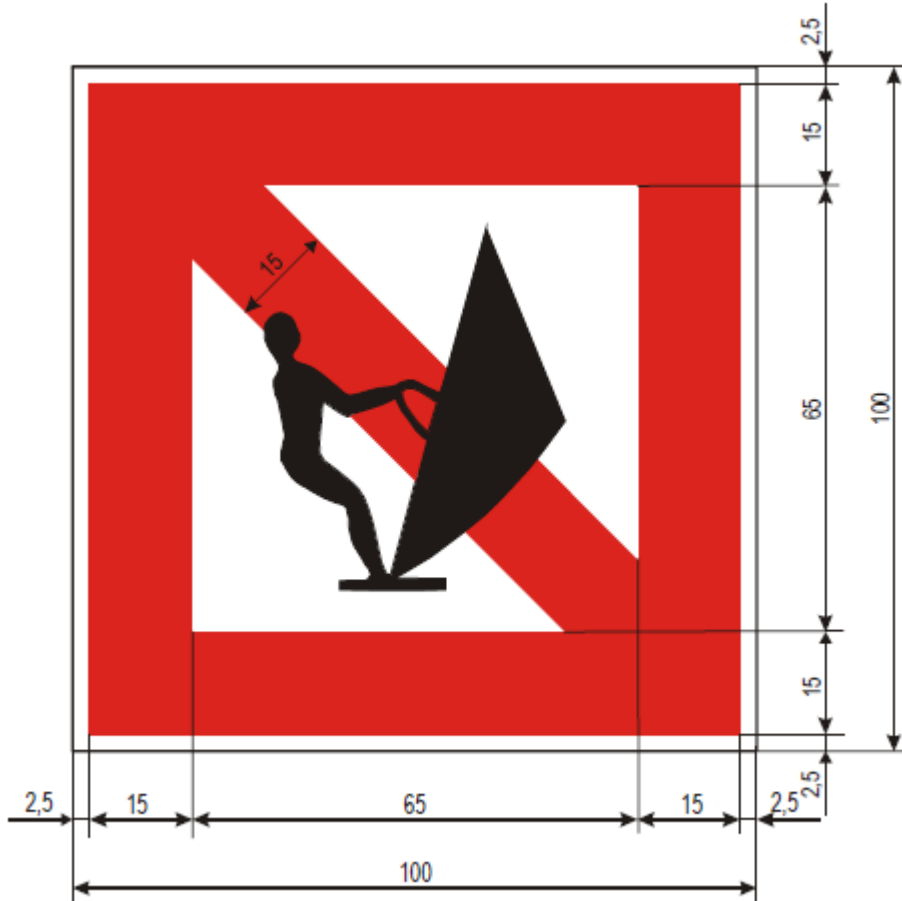

A.18

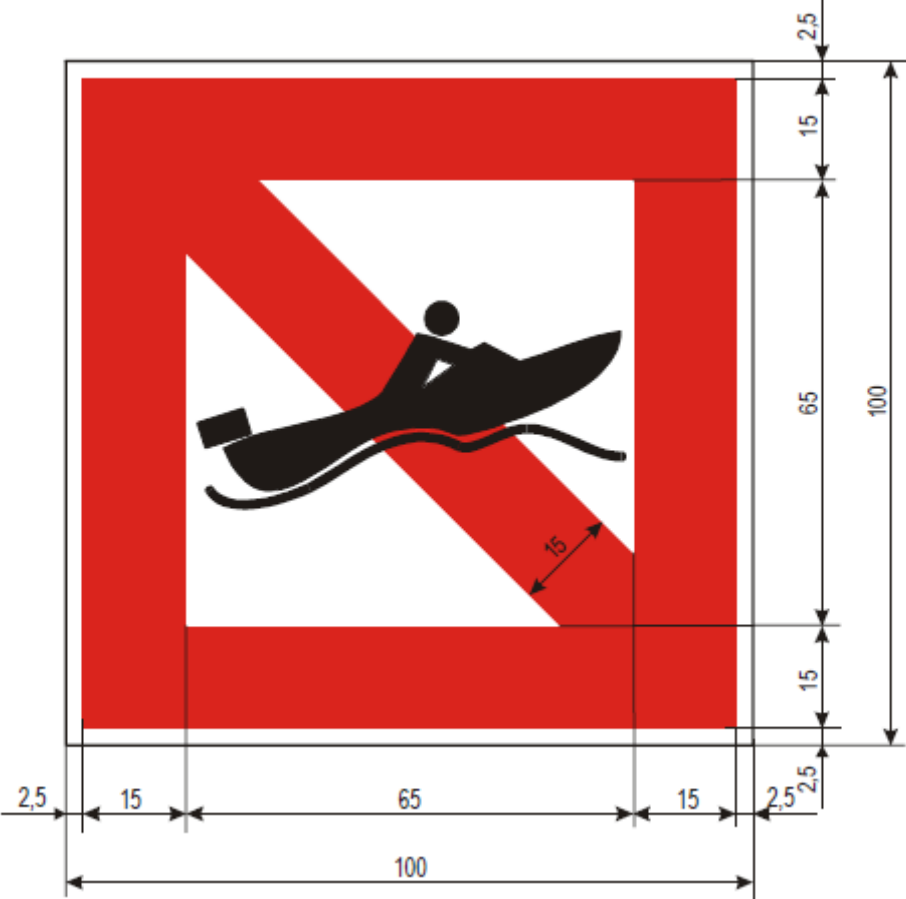

A.19

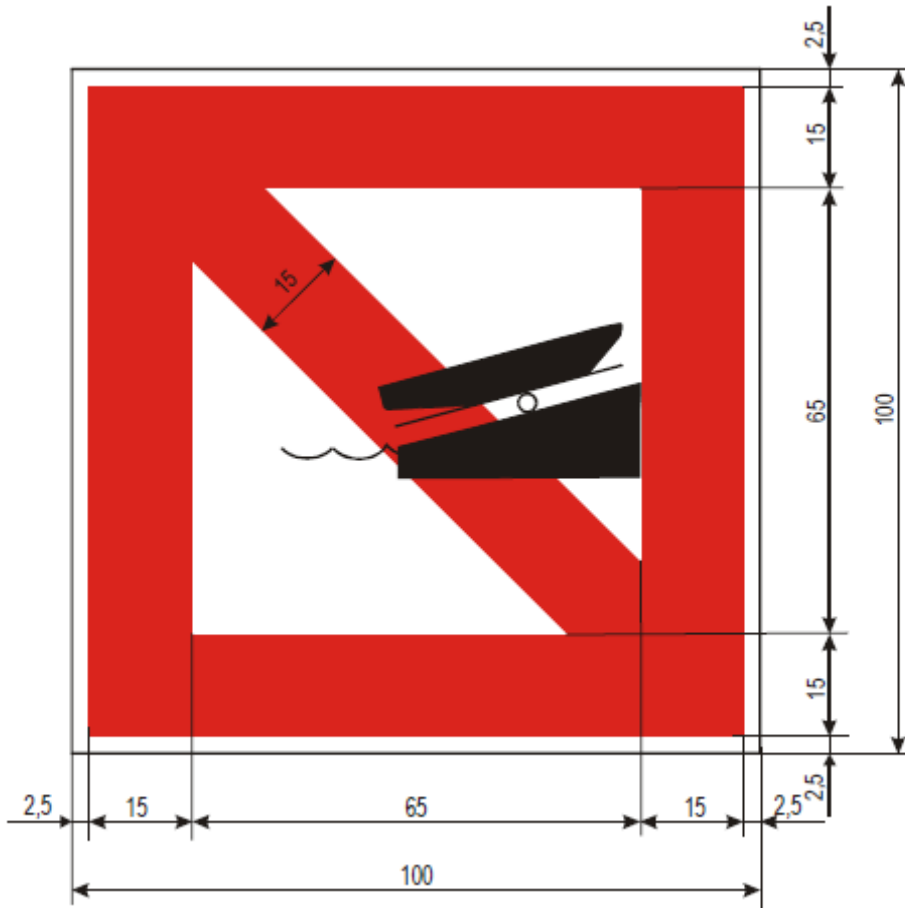

A.20

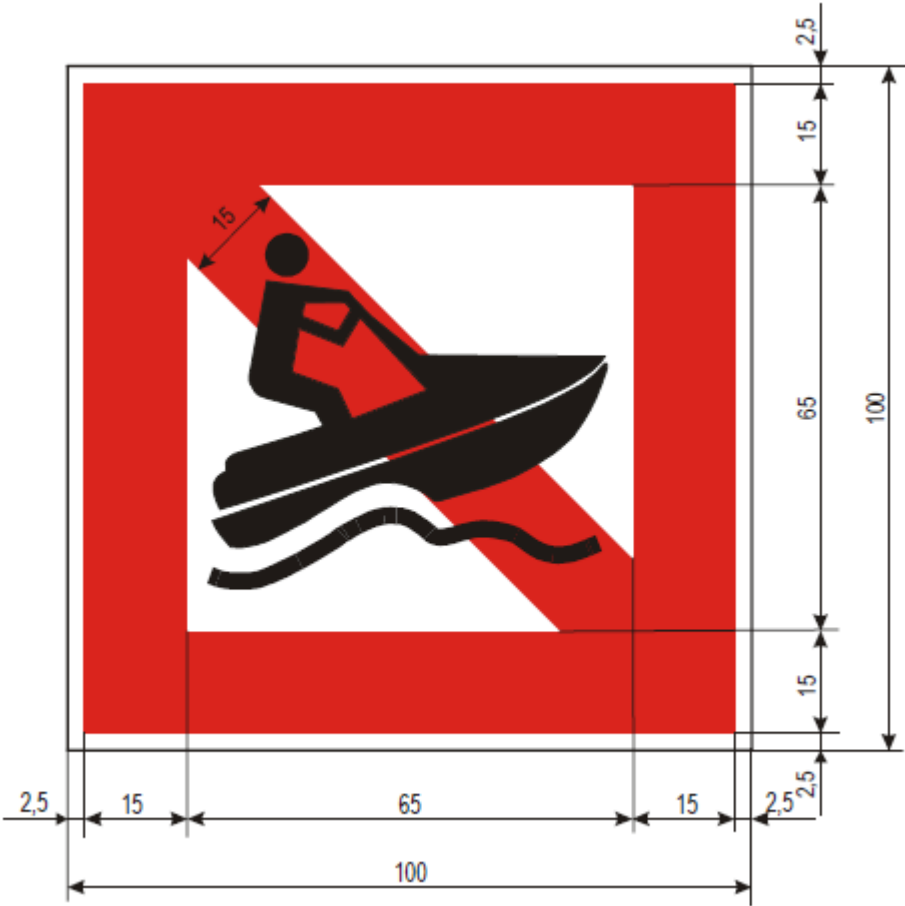

B.1

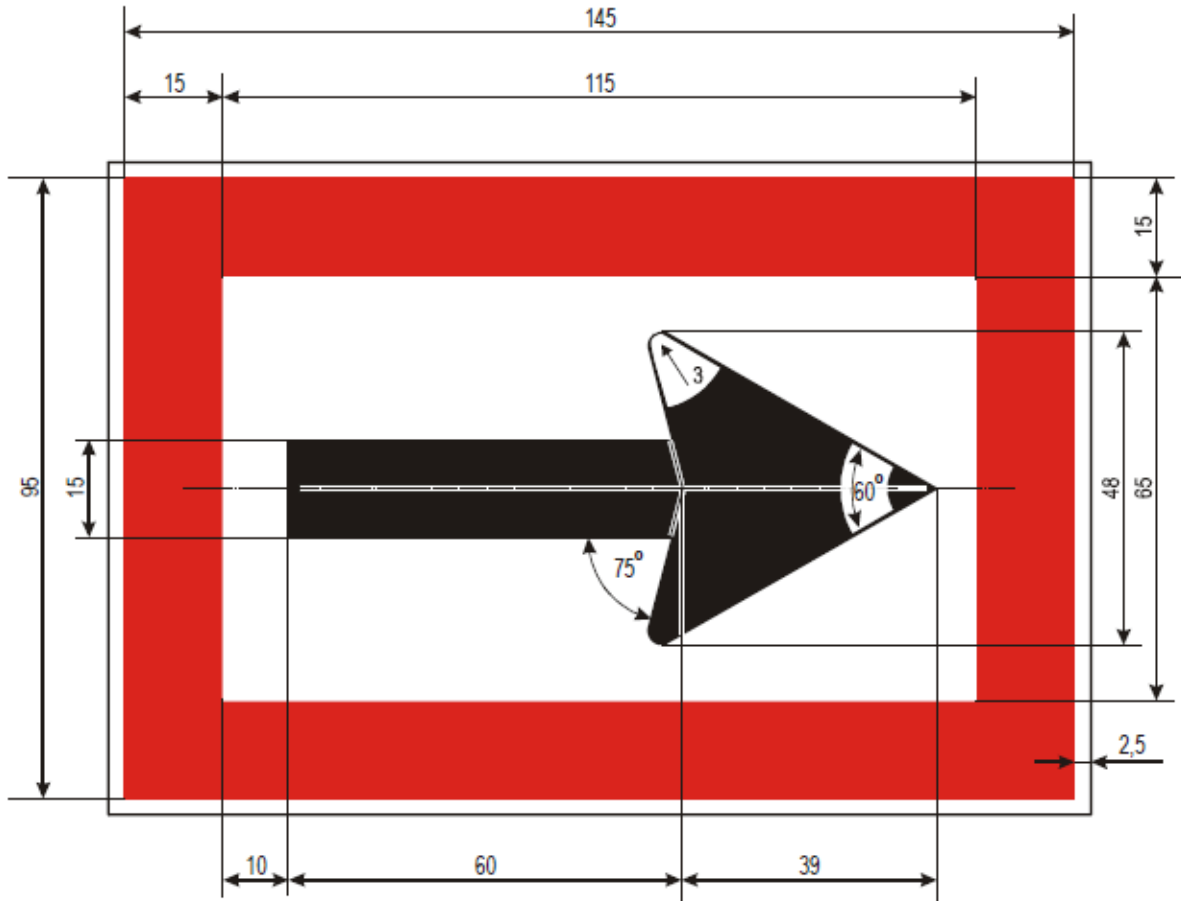

B.2a

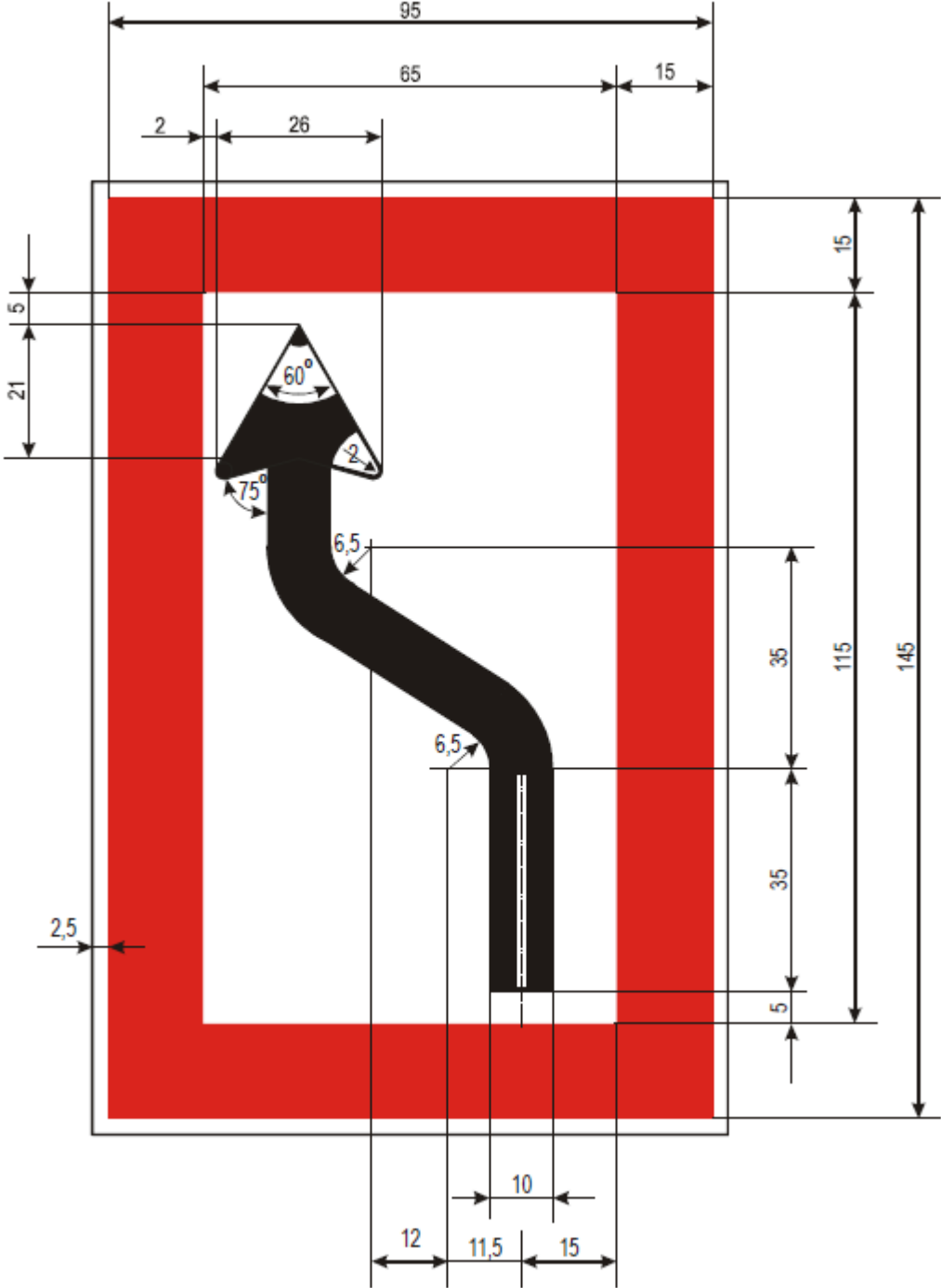

B.2b

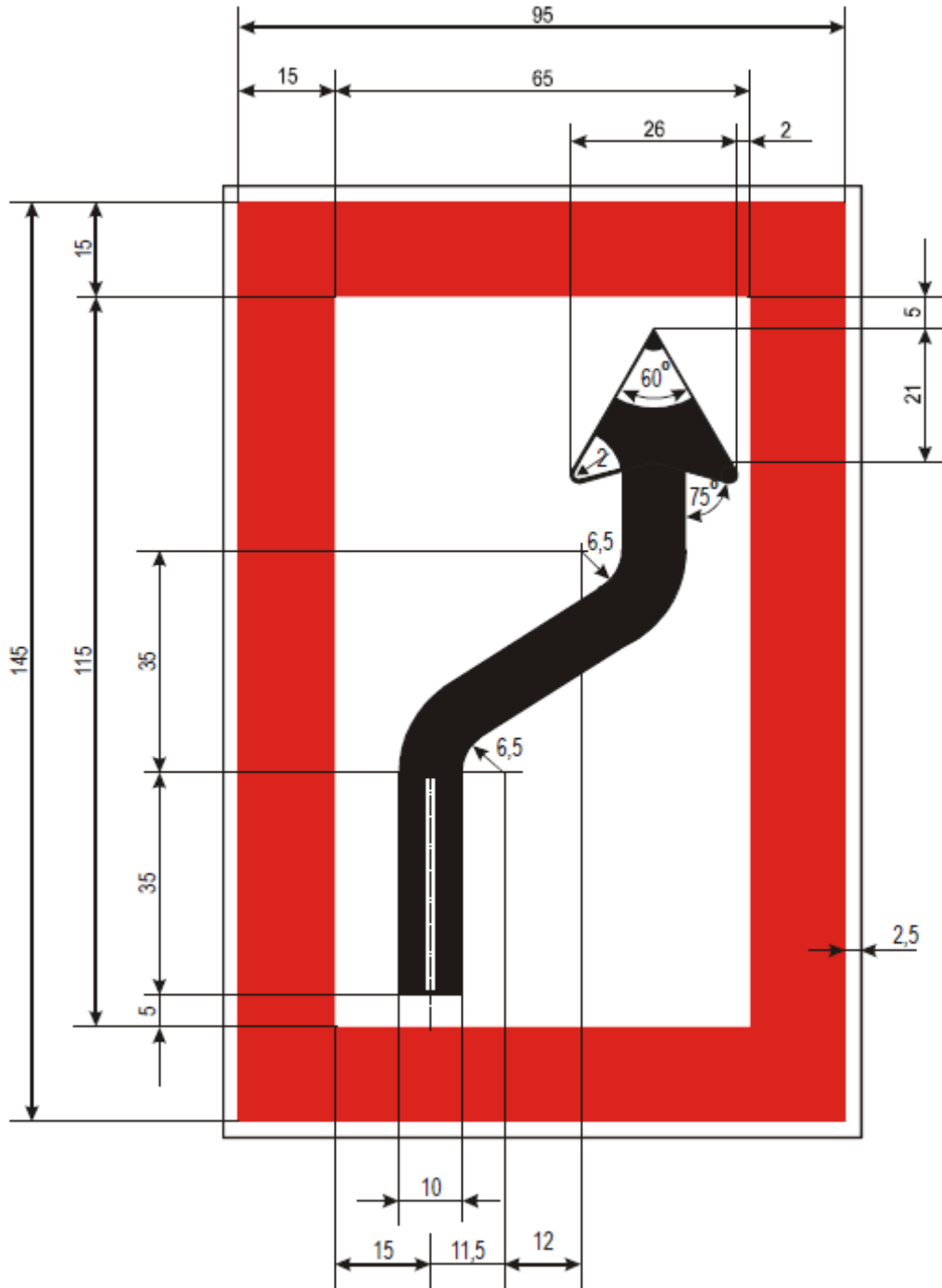

B.3a

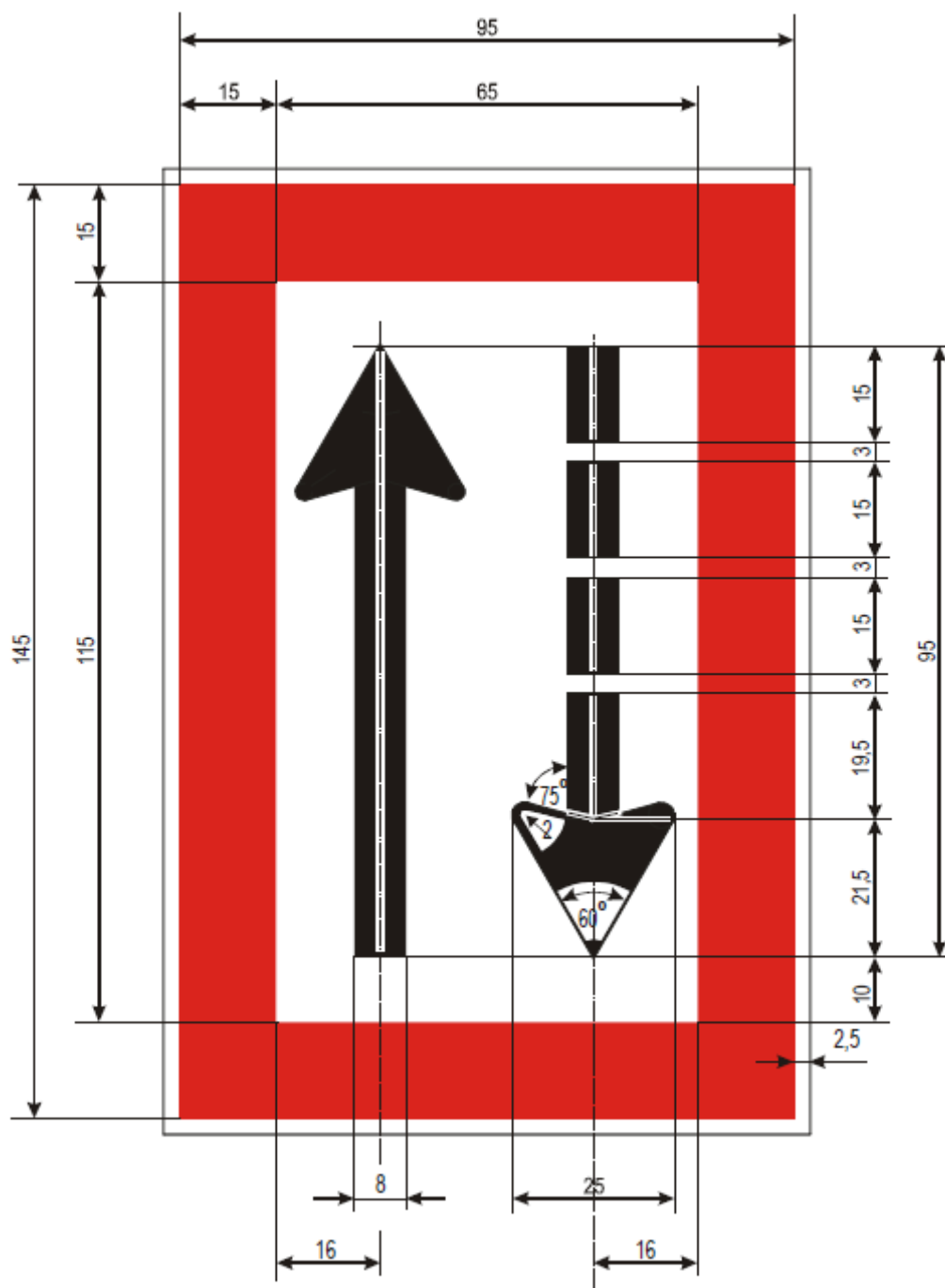

B.3b

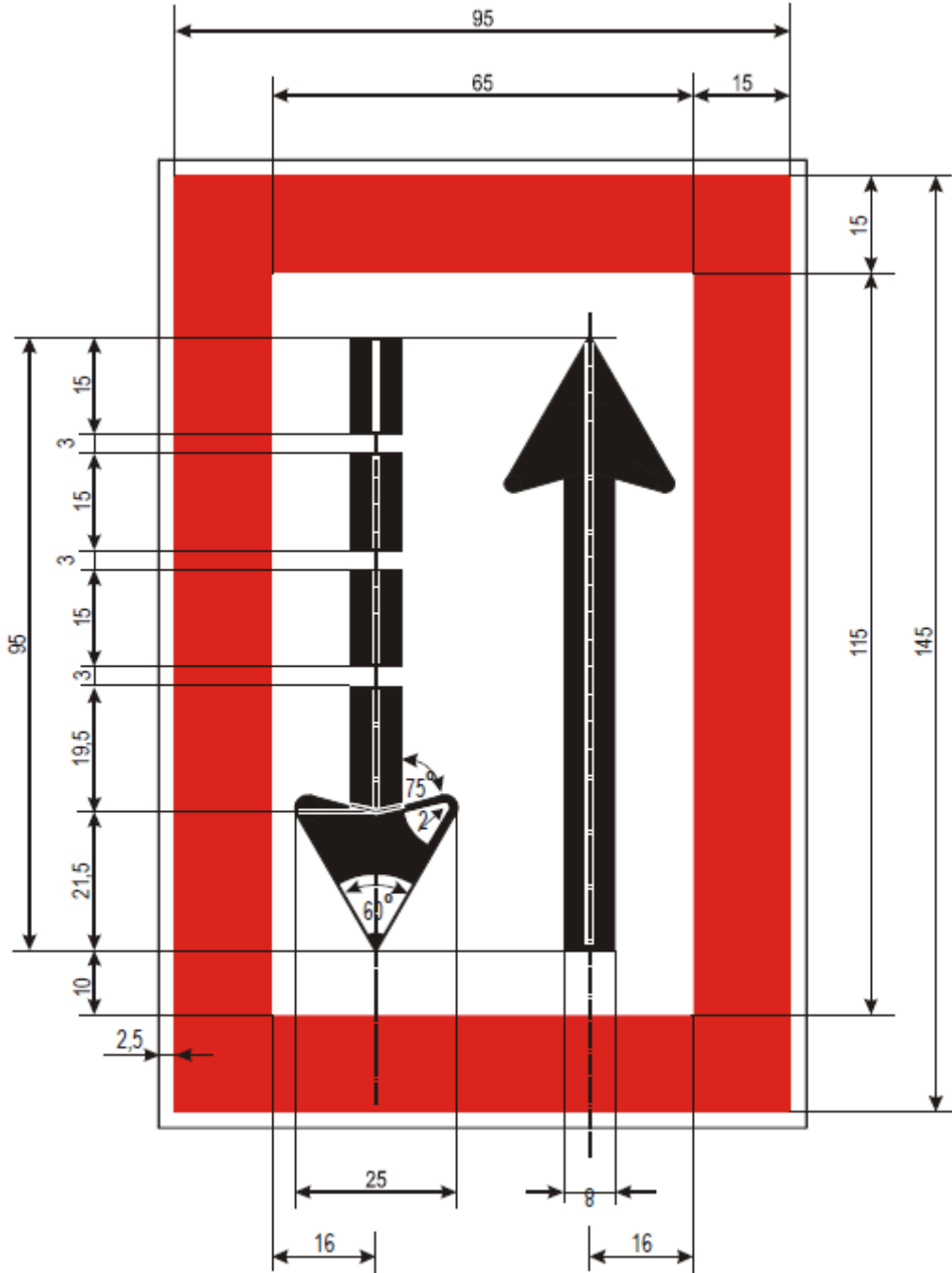

B.4a

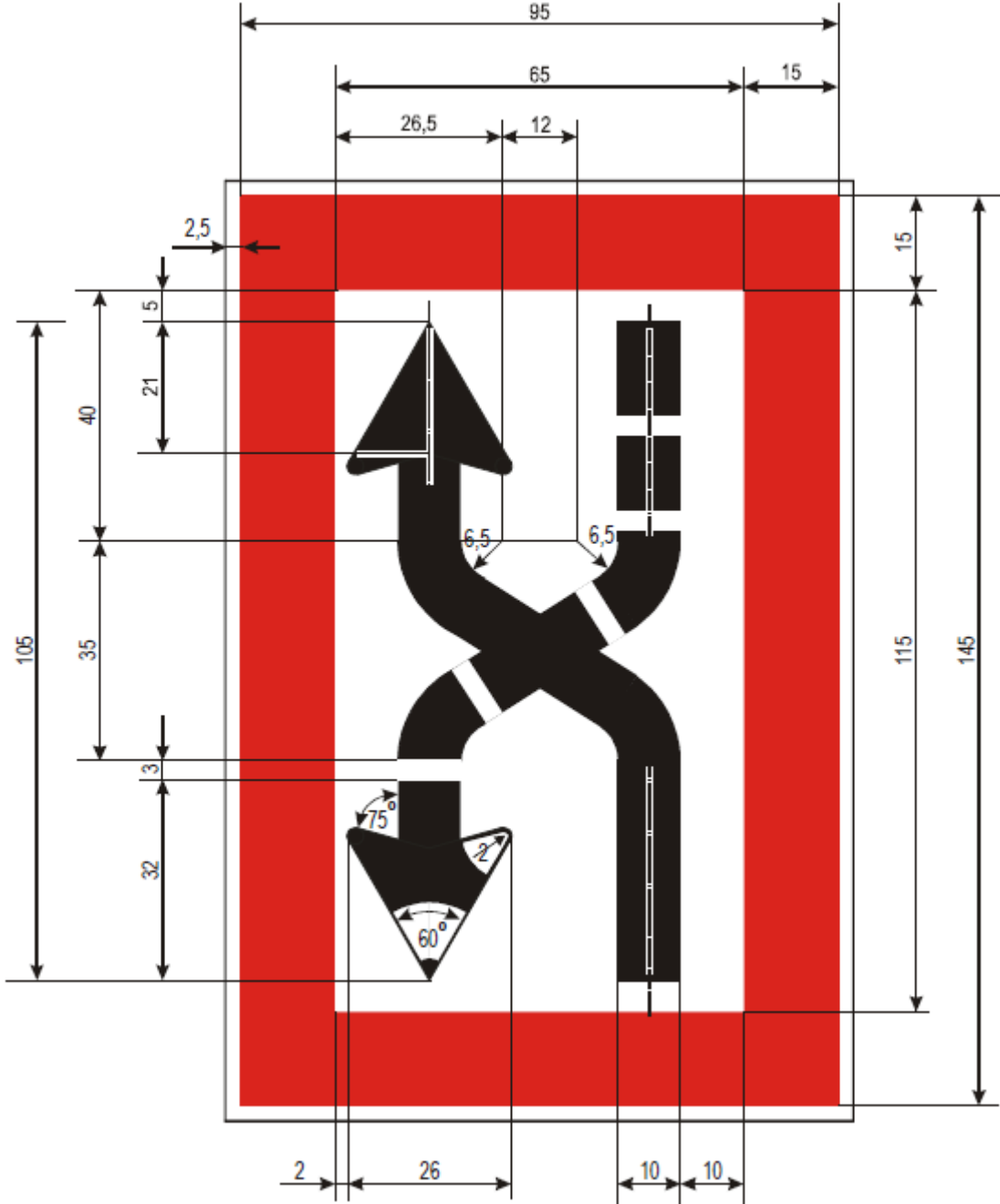

B.4b

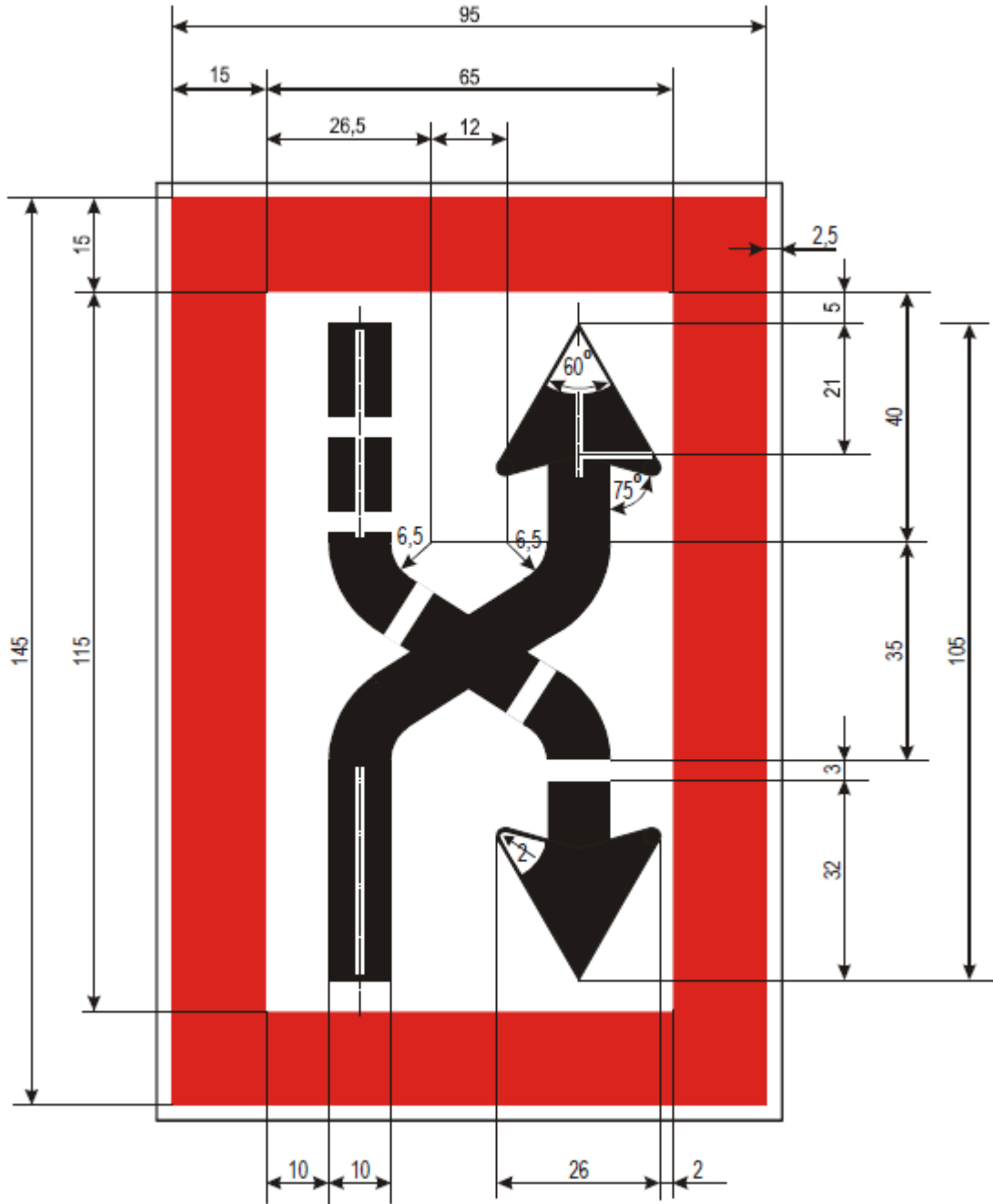

B.5

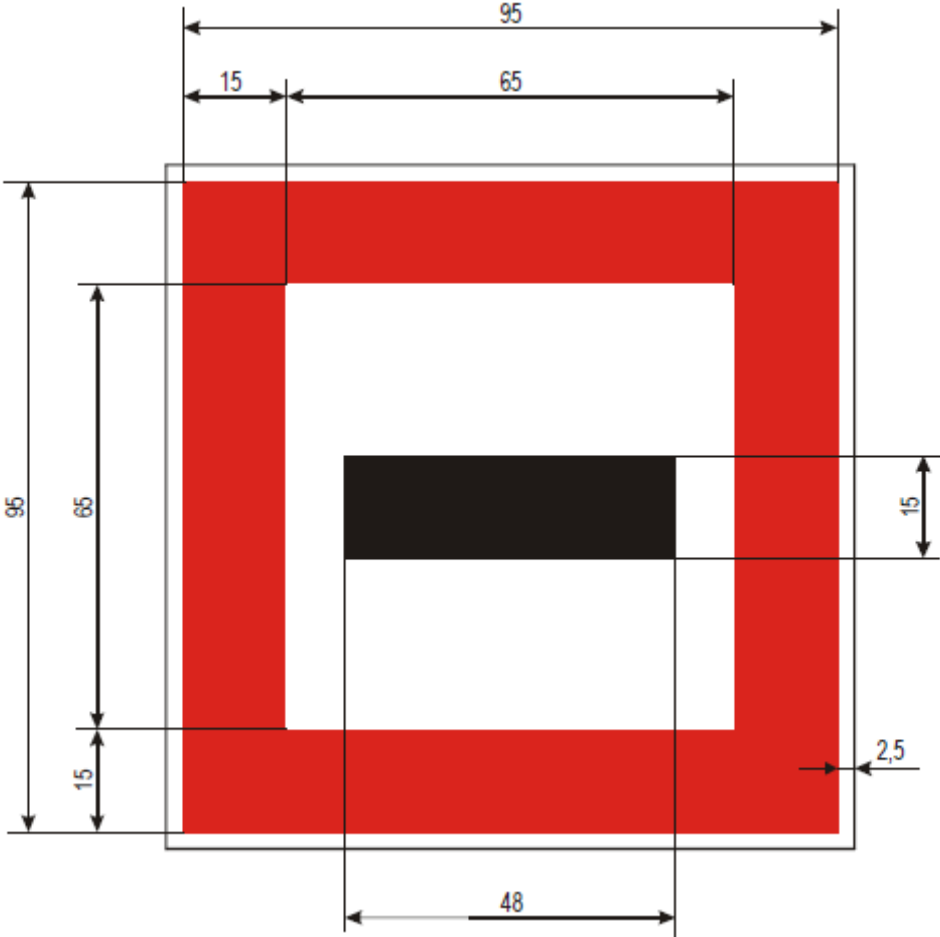

B.6

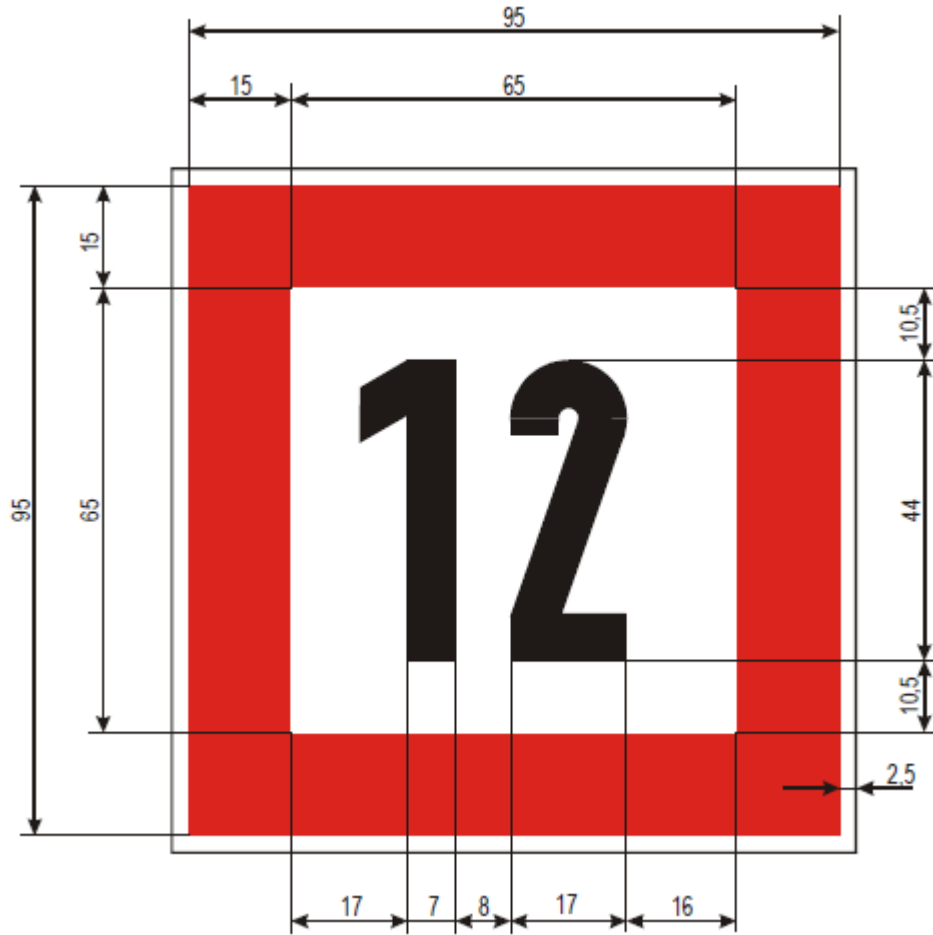

B.7

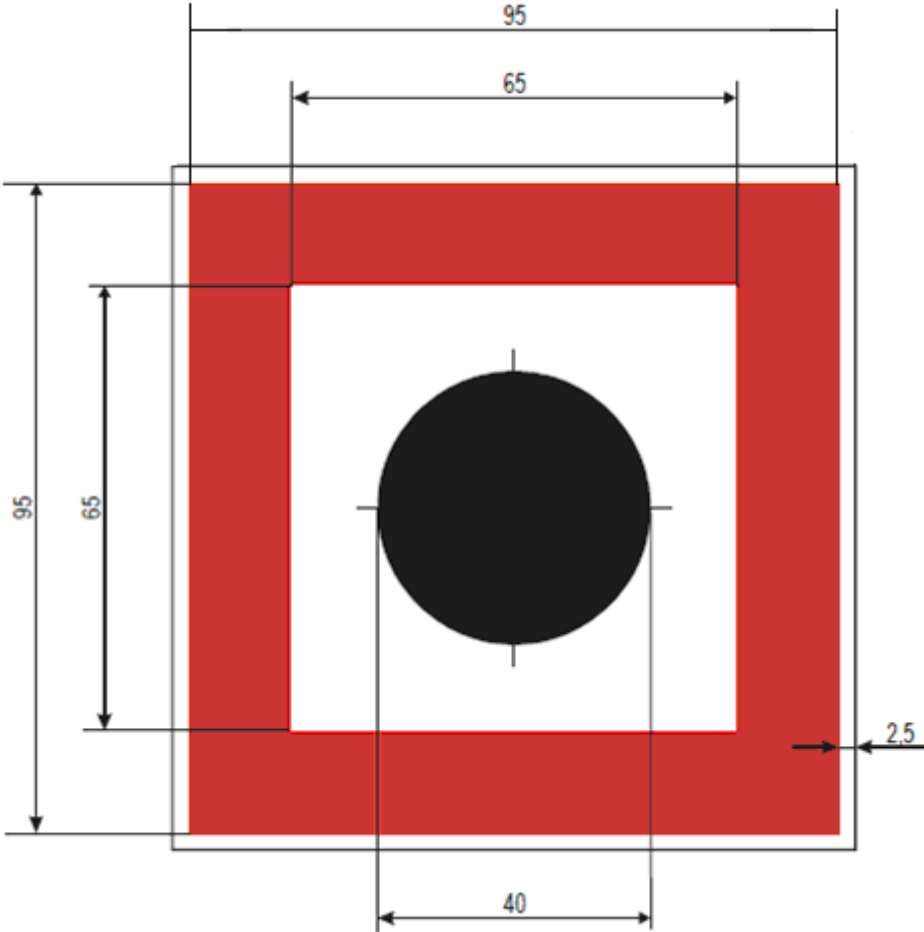

B.8

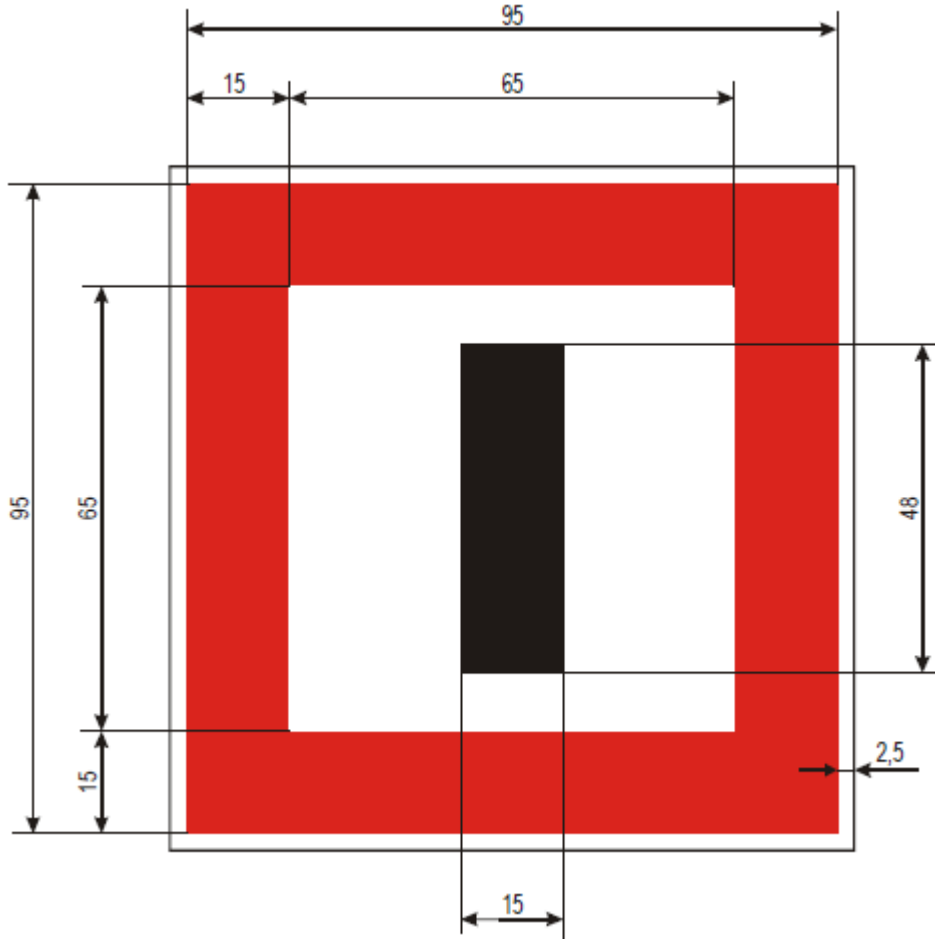

B.9a

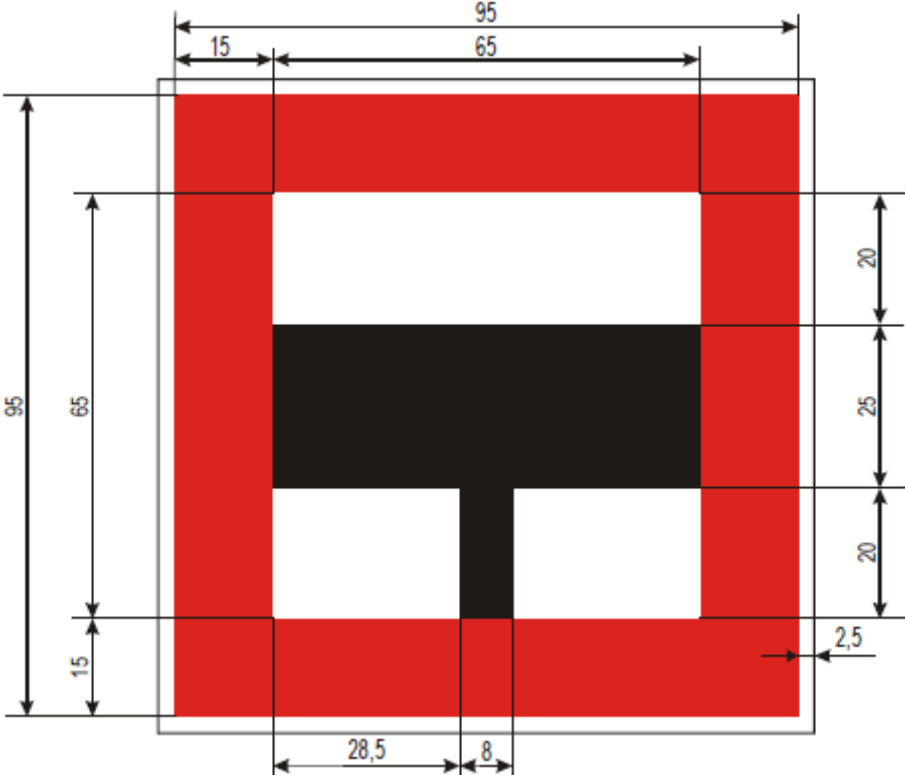

B.9b

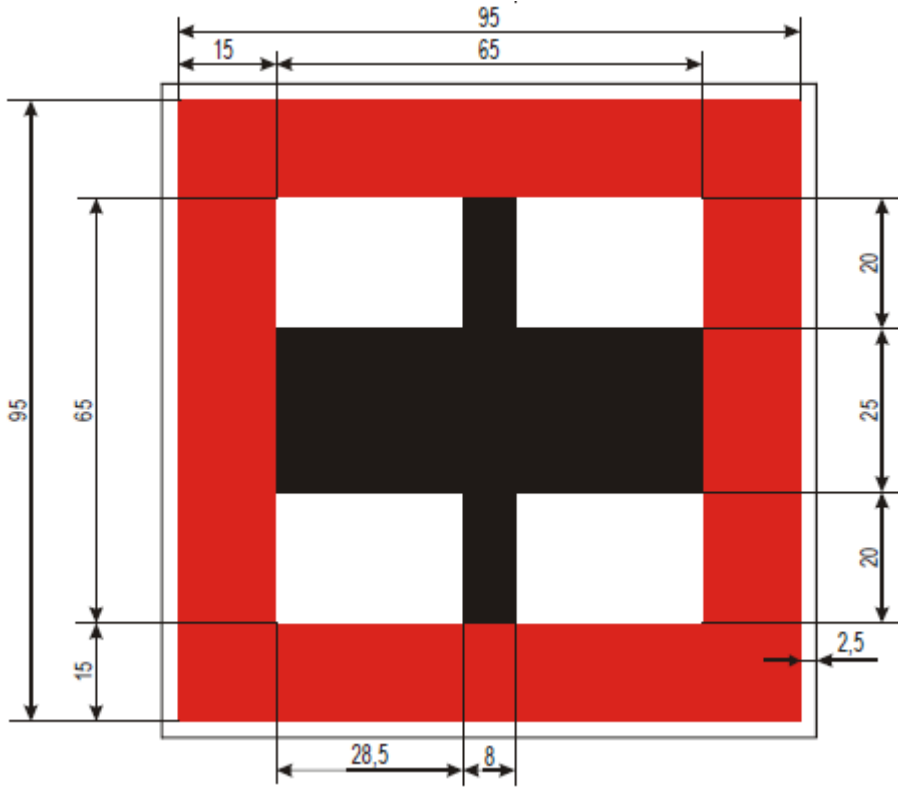

B.11a

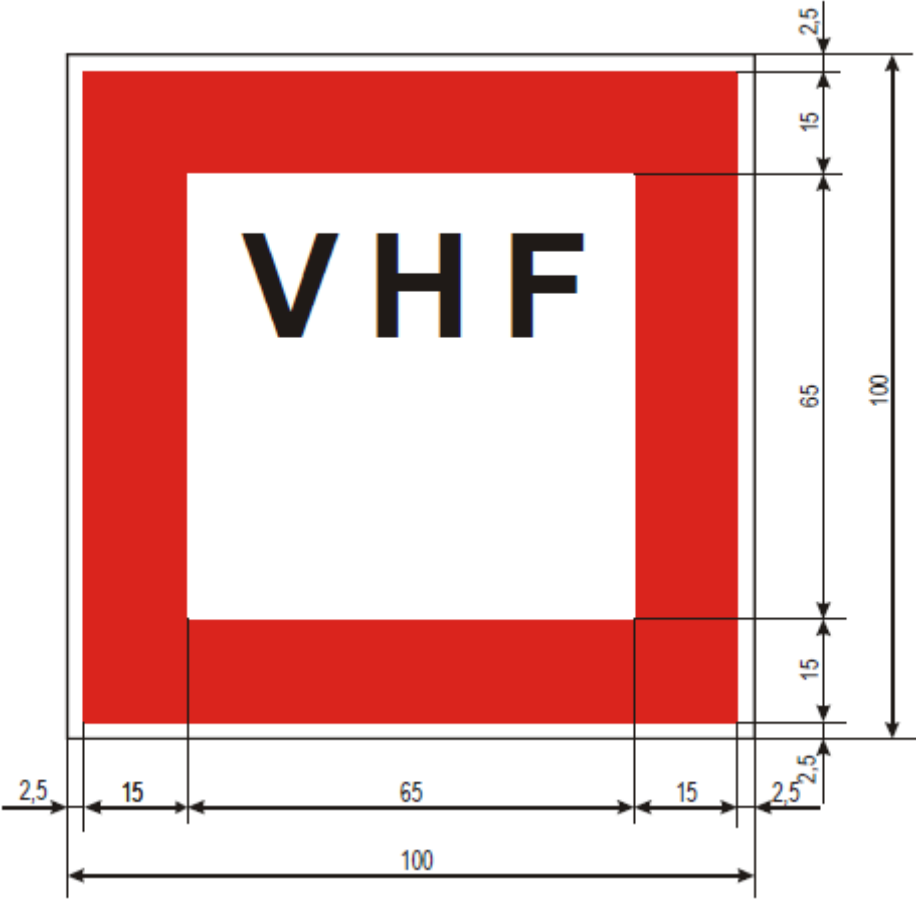

B.11b

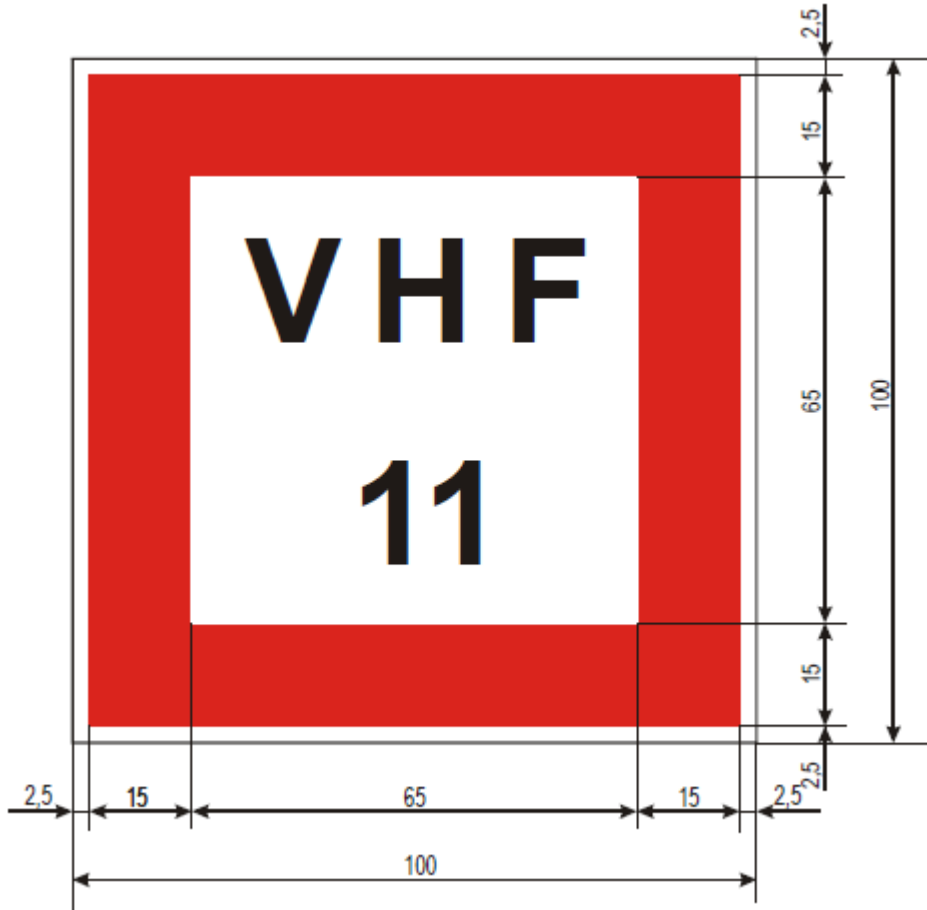

C.1a

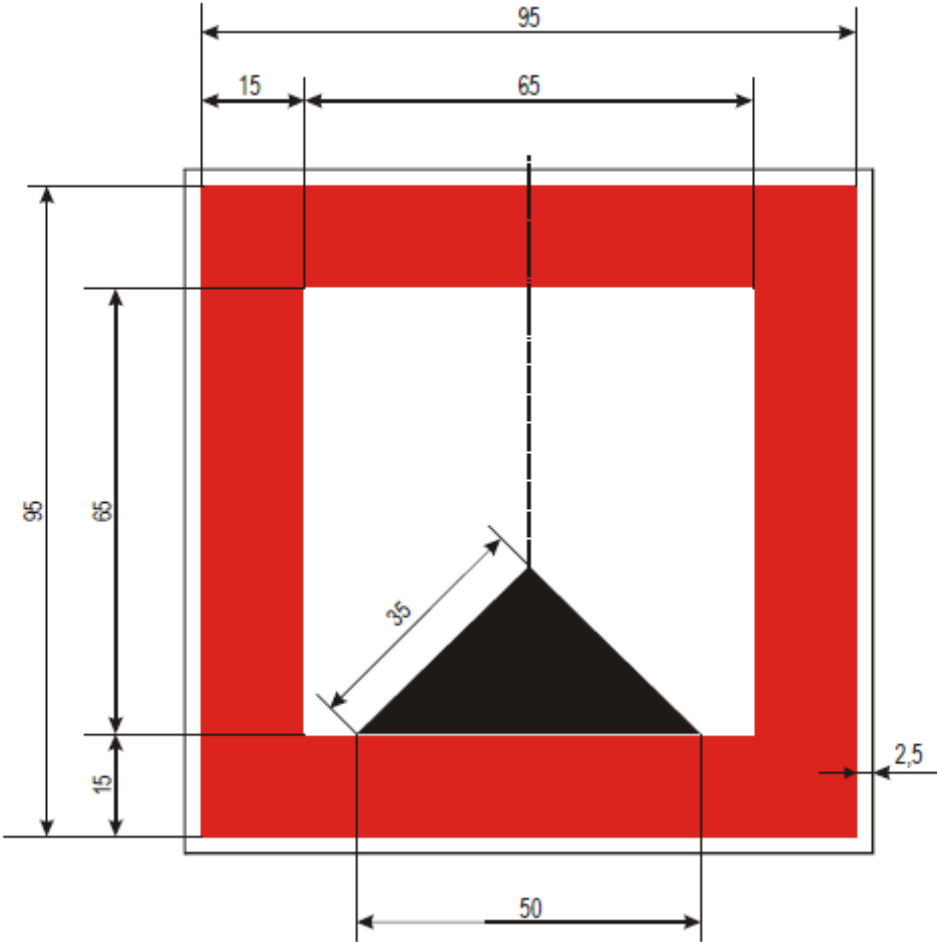

C.1b

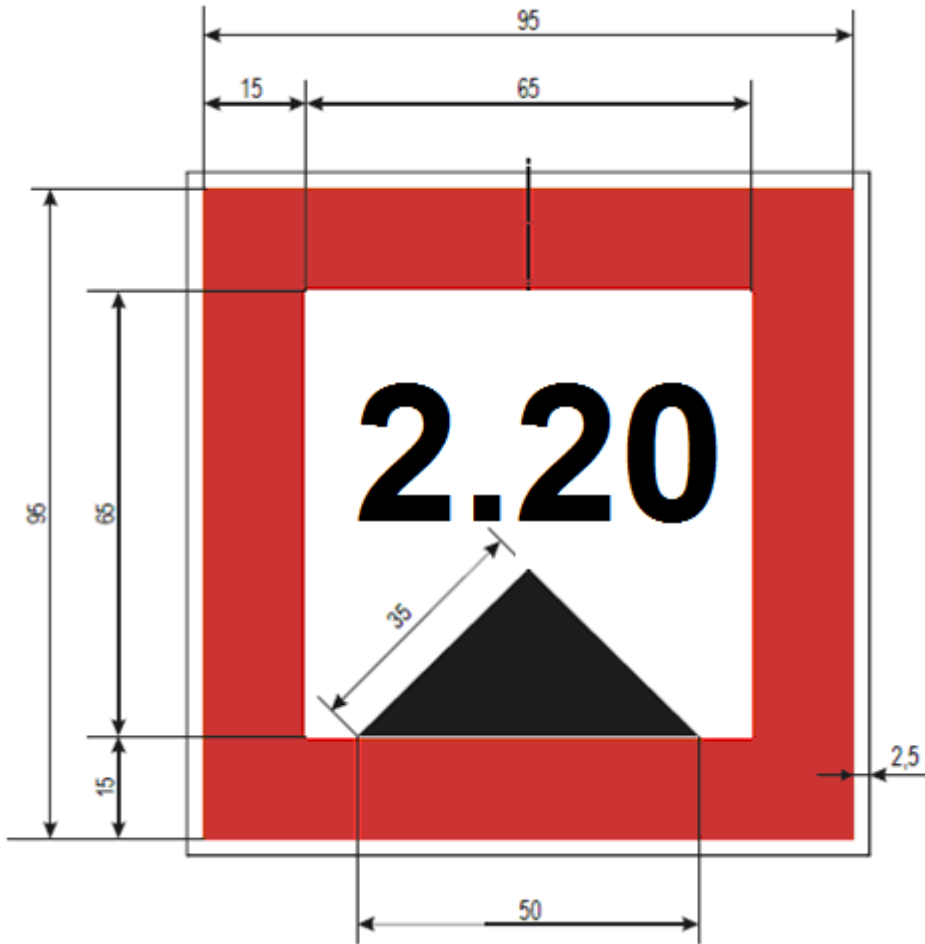

C.2a

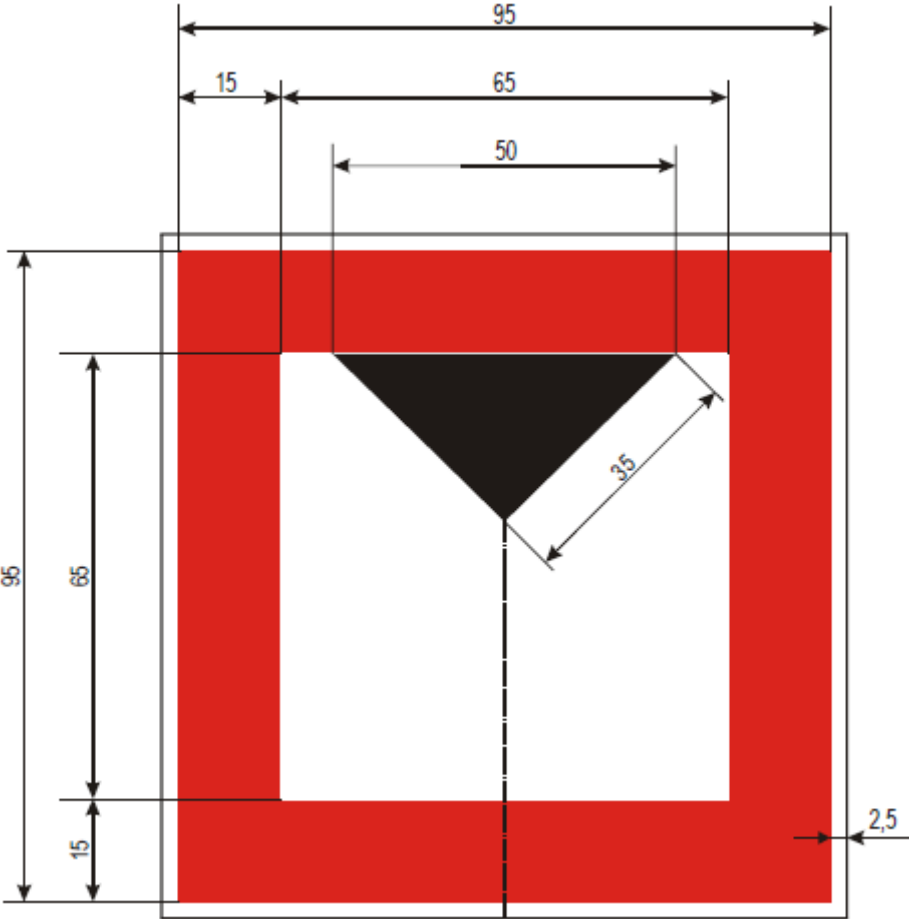

C.2b

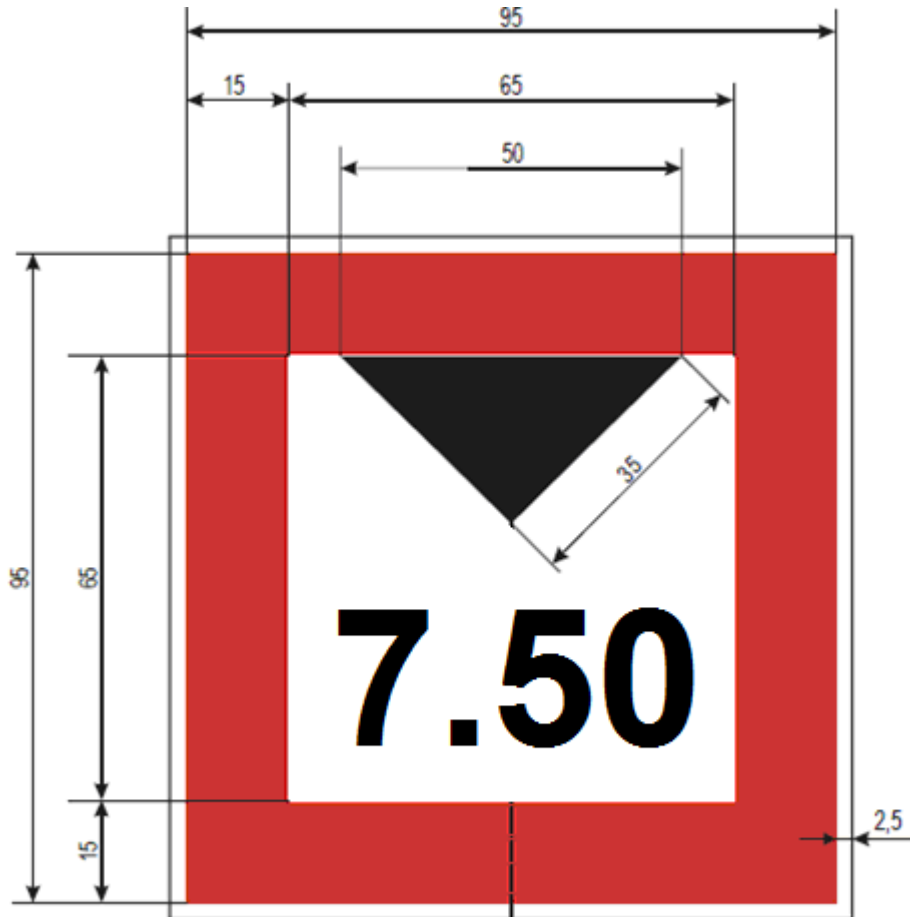

C.3a

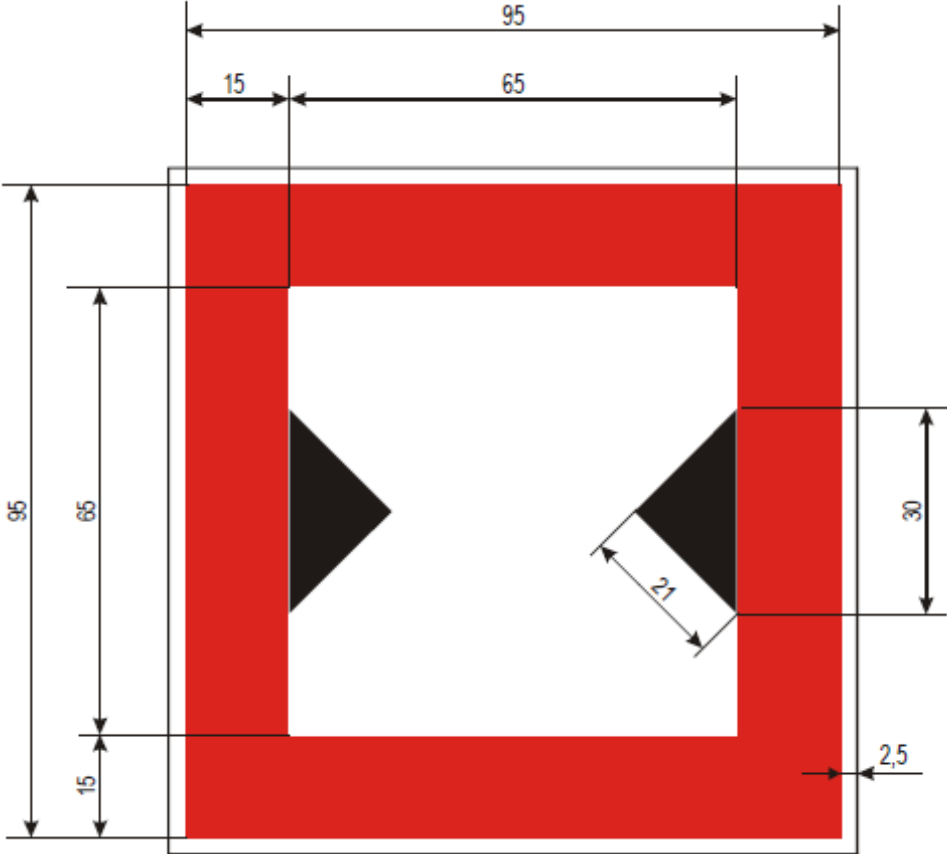

C.3b

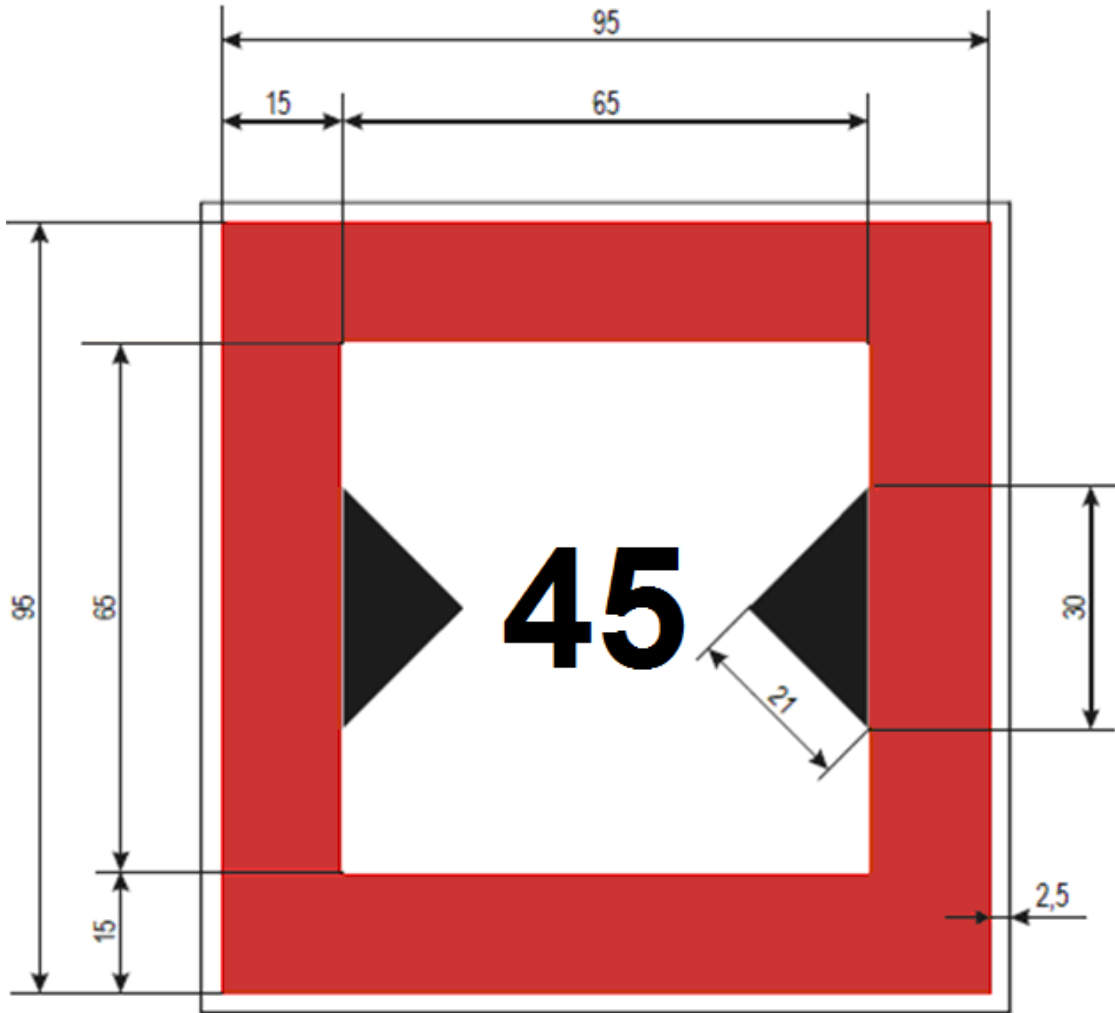

C.4

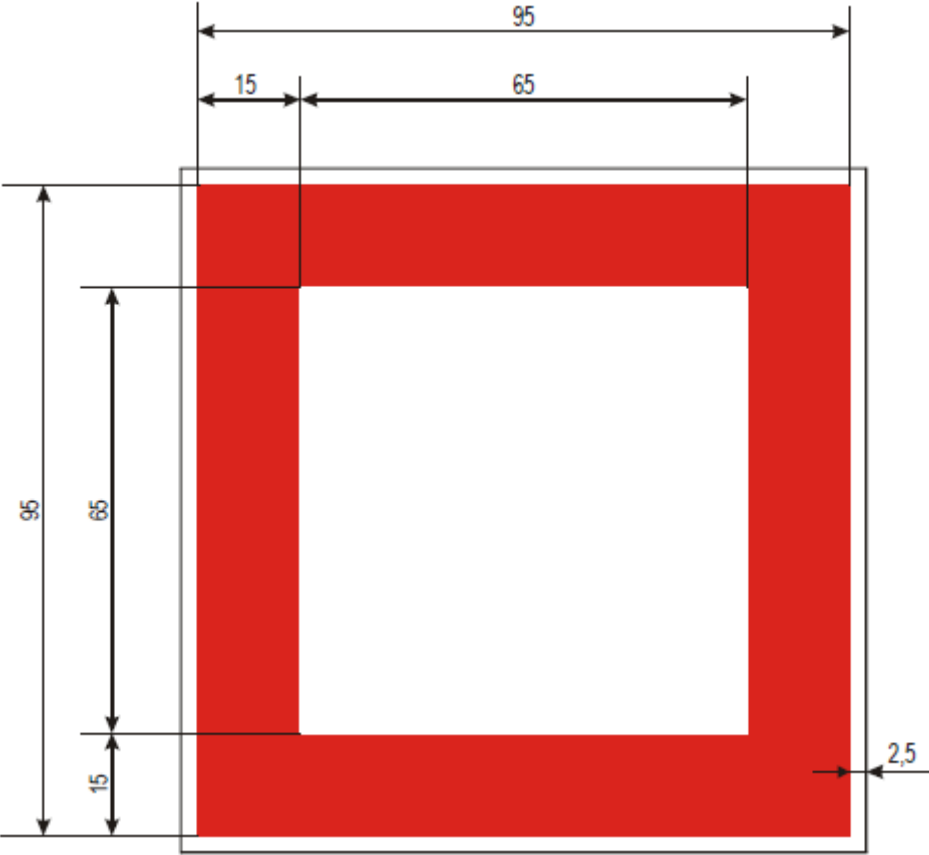

C.5

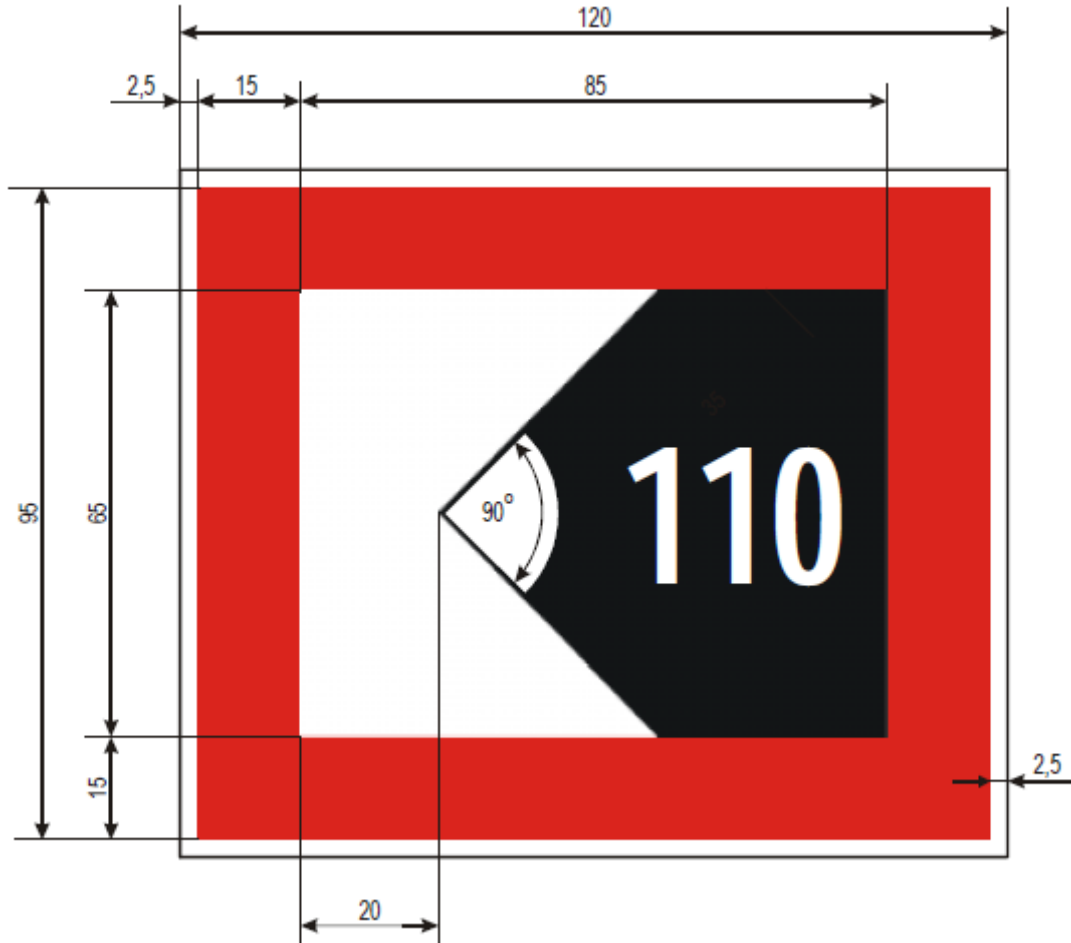

D.1a

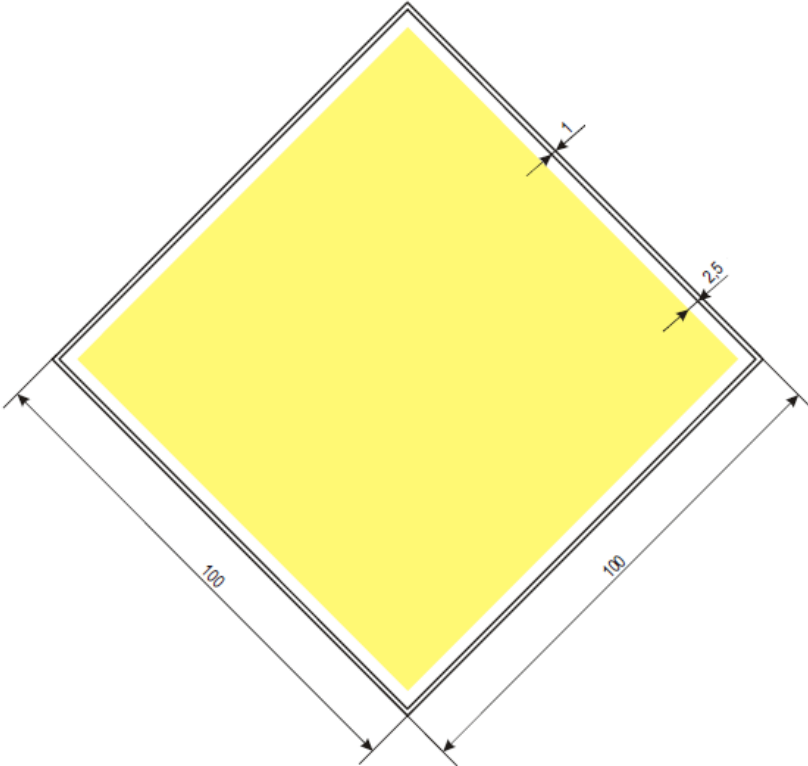

D.1c

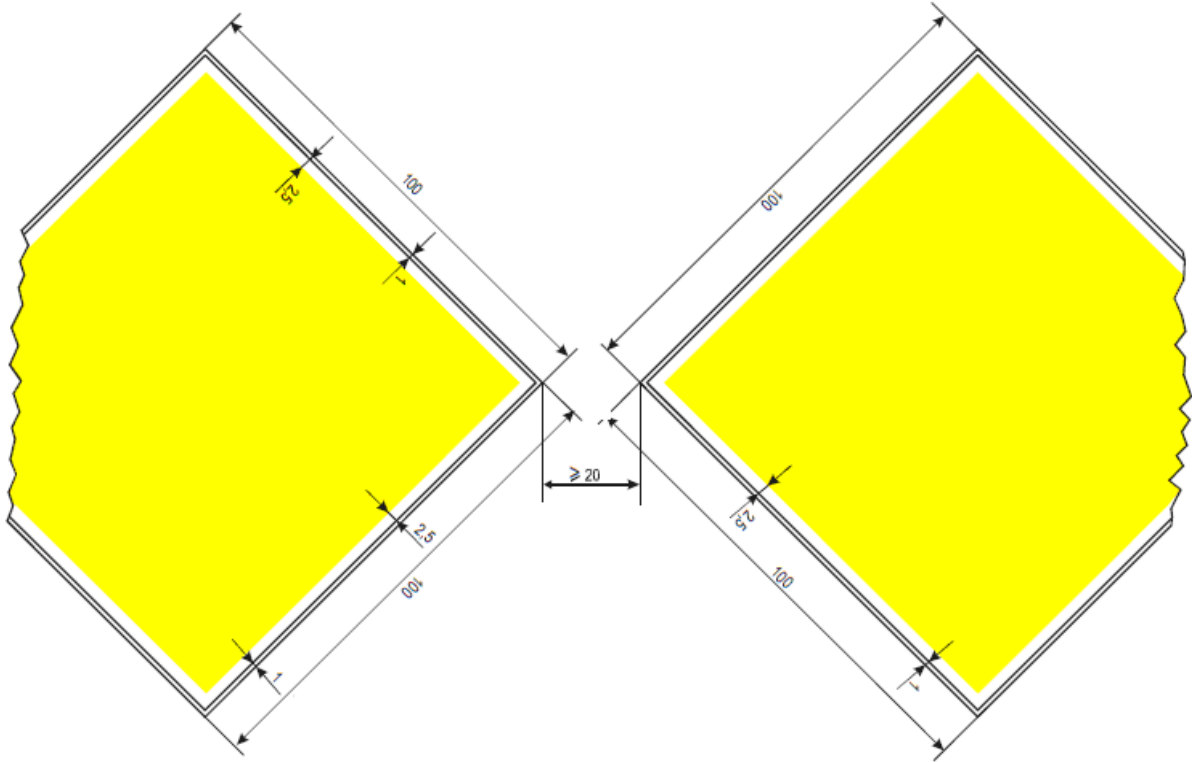

D.1d

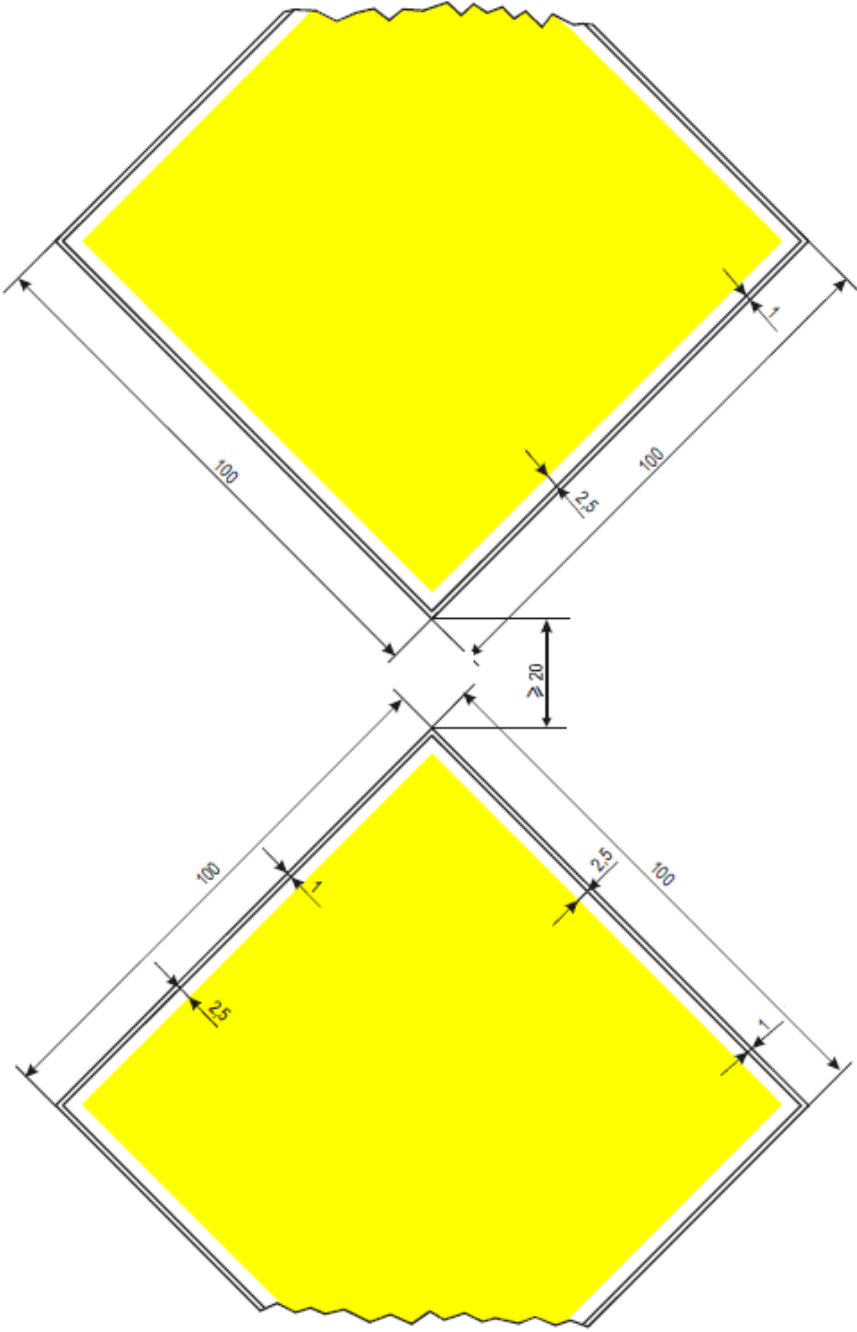

D.2a

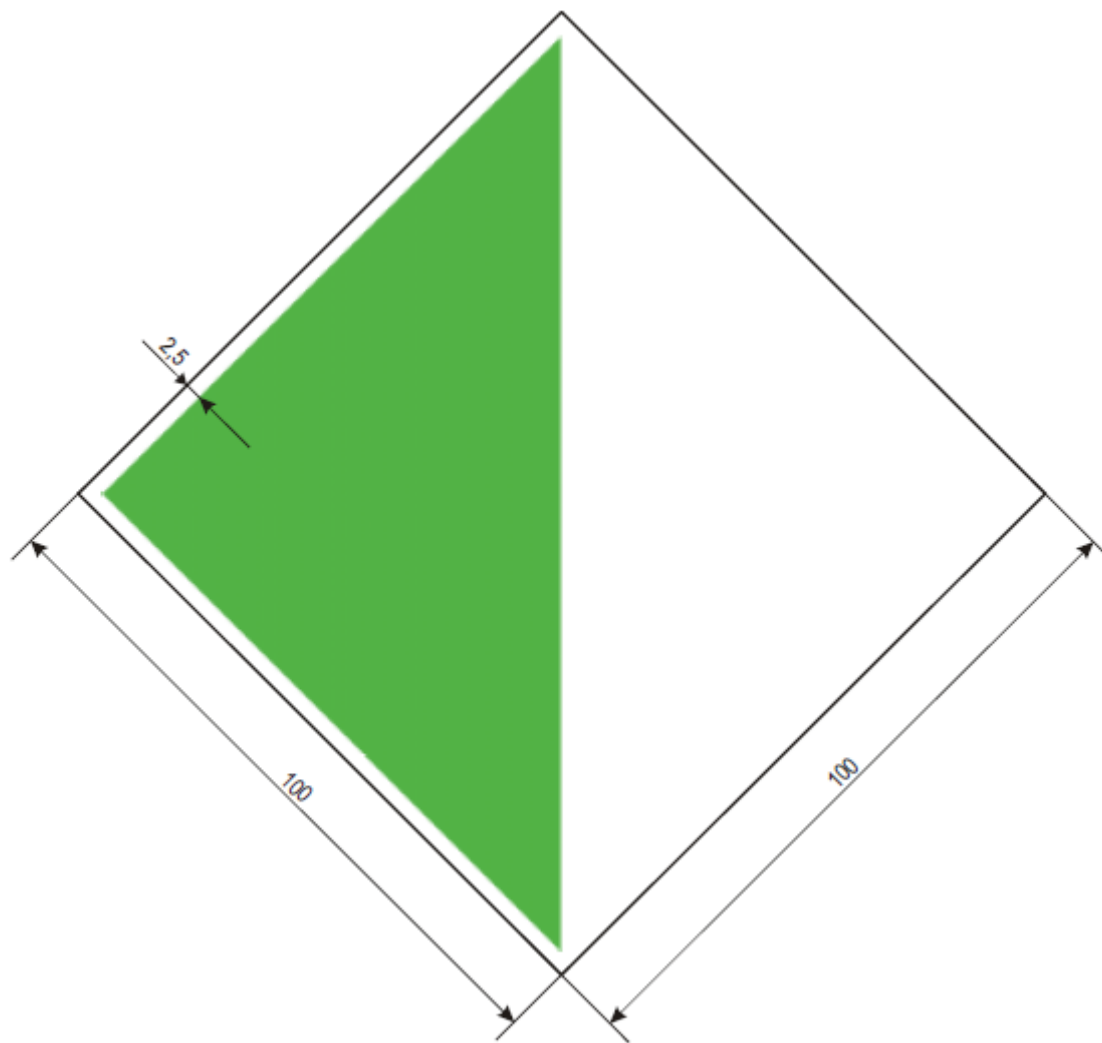

D.3a

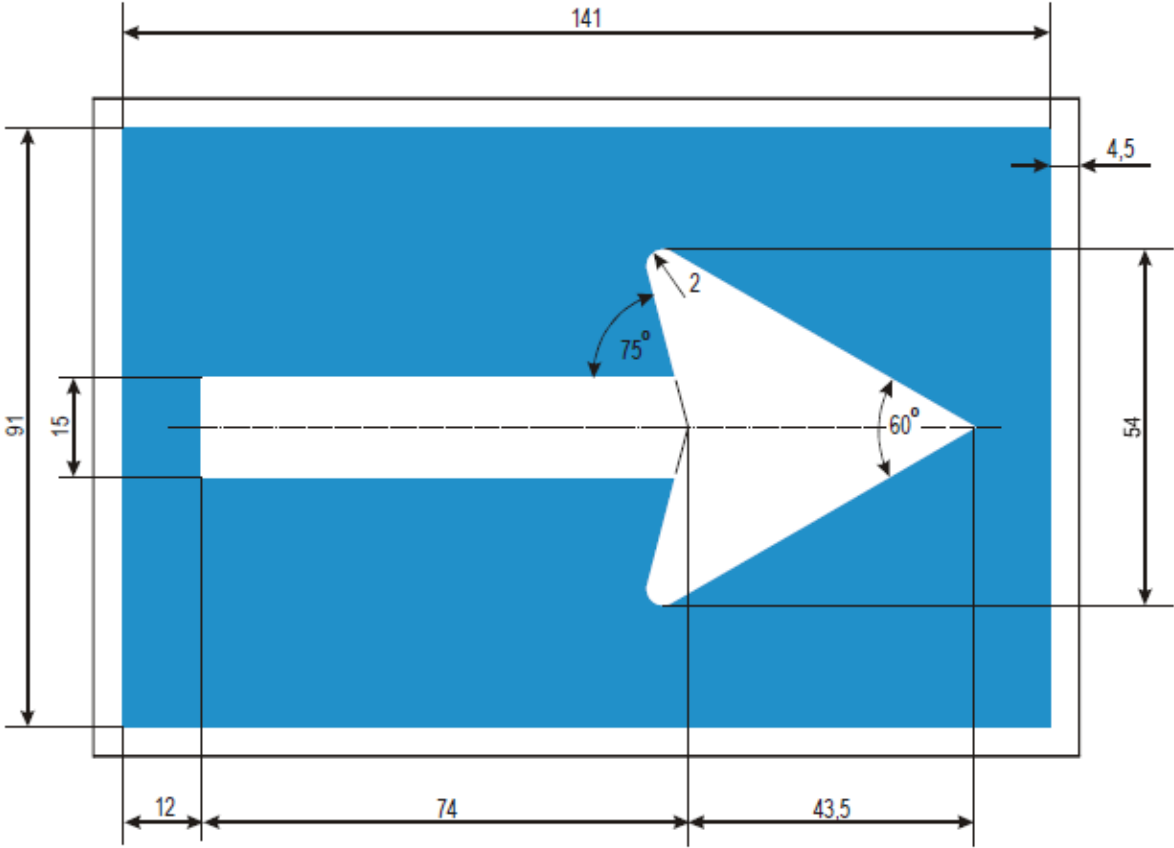

E.1a

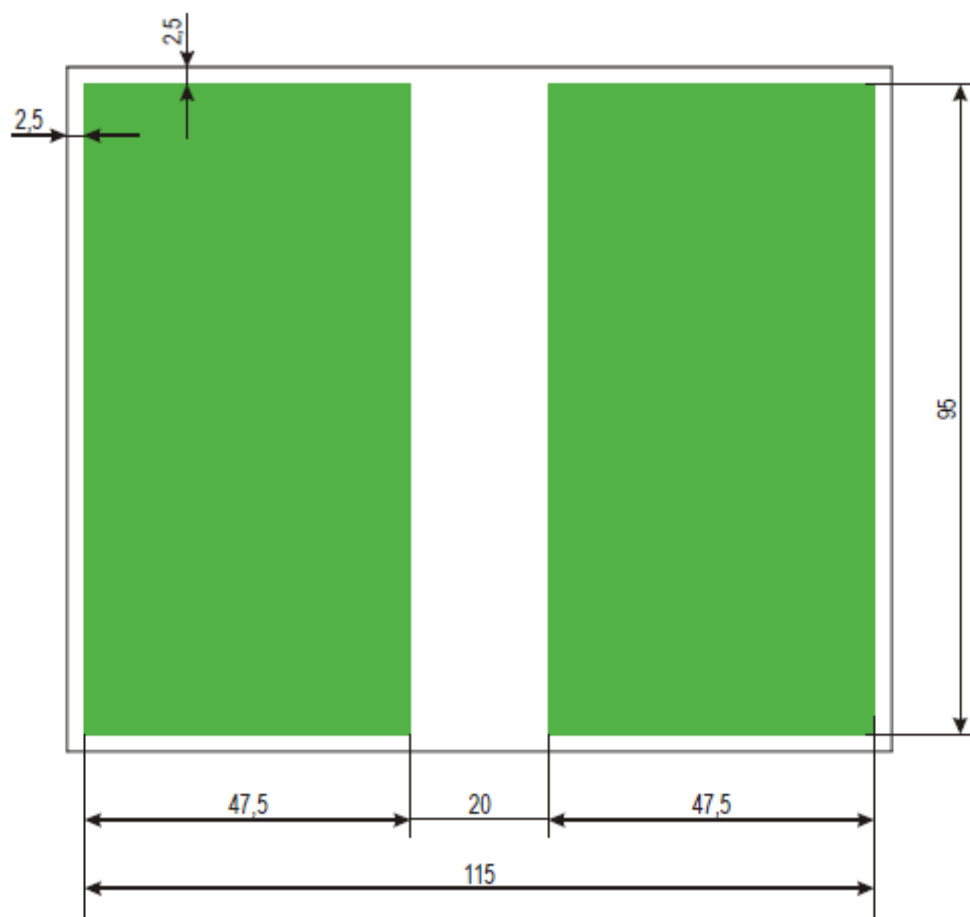

E.2

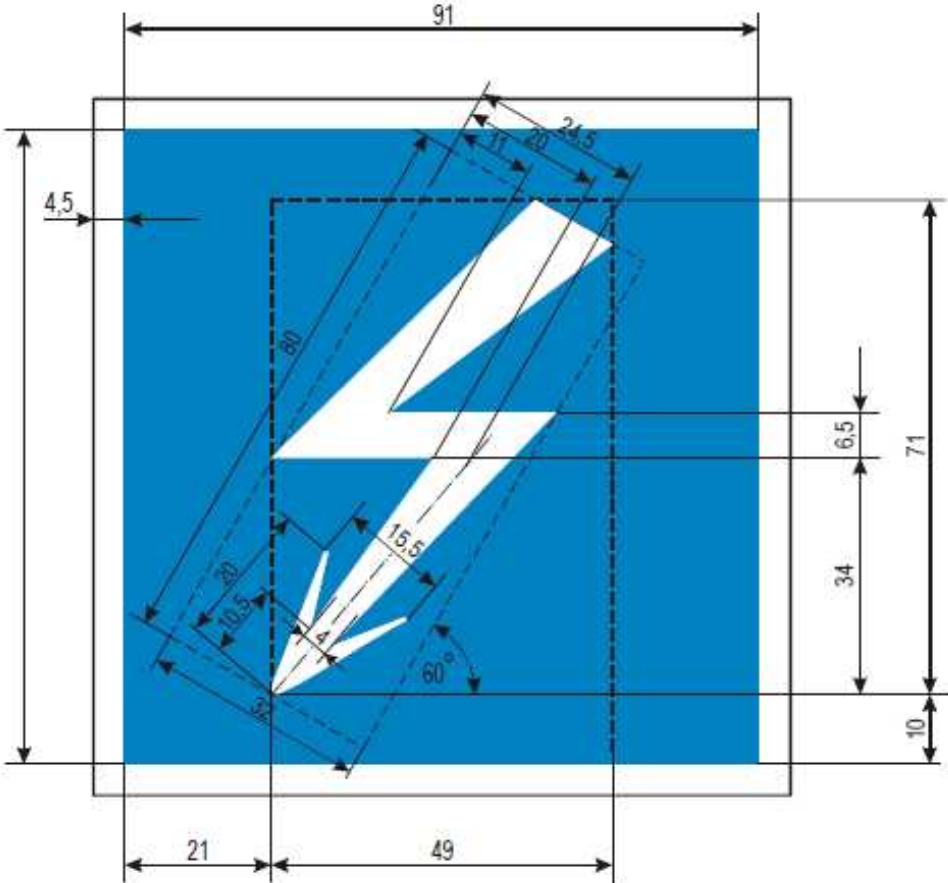

E.3

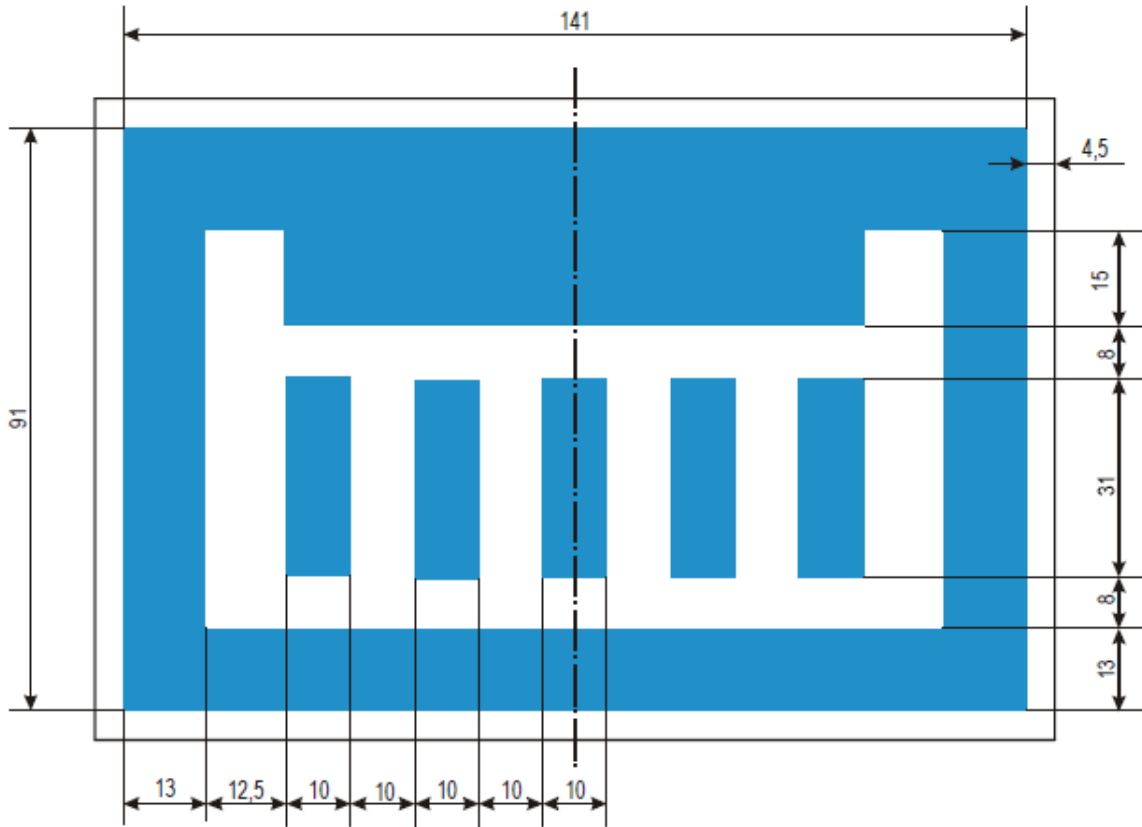

E.4a

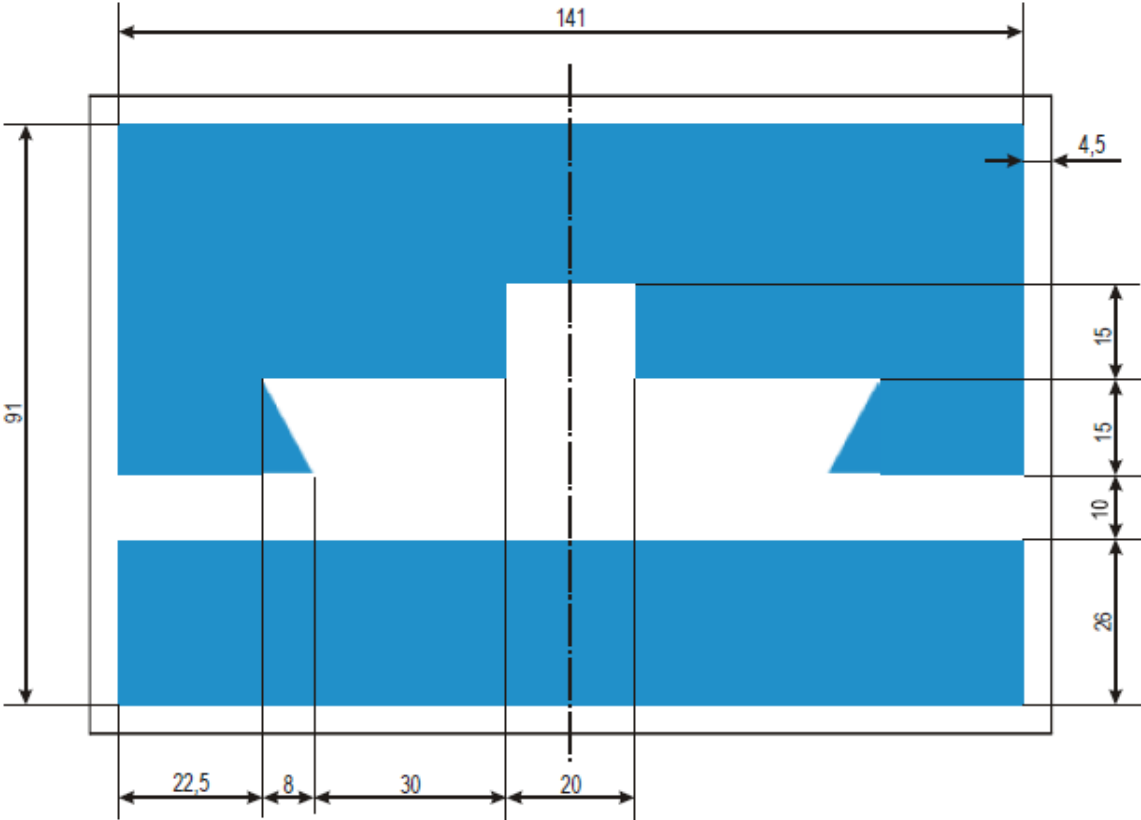

E.4b

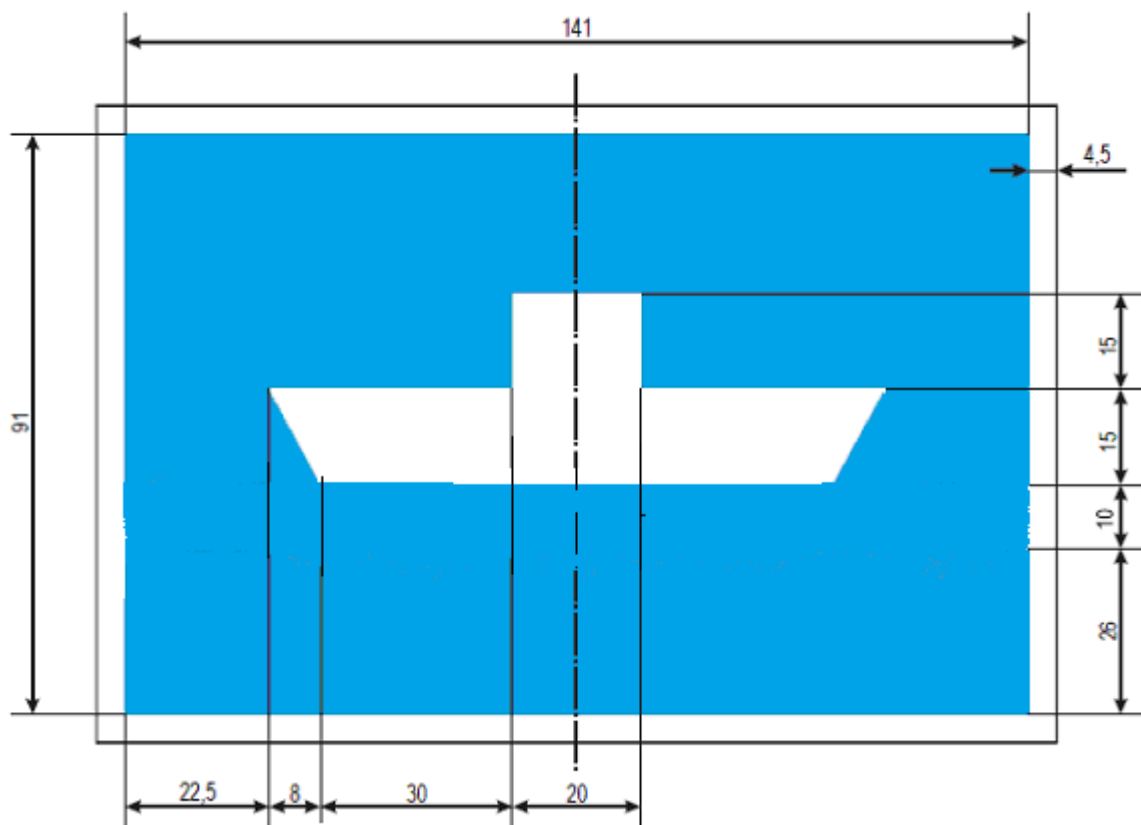

E.5

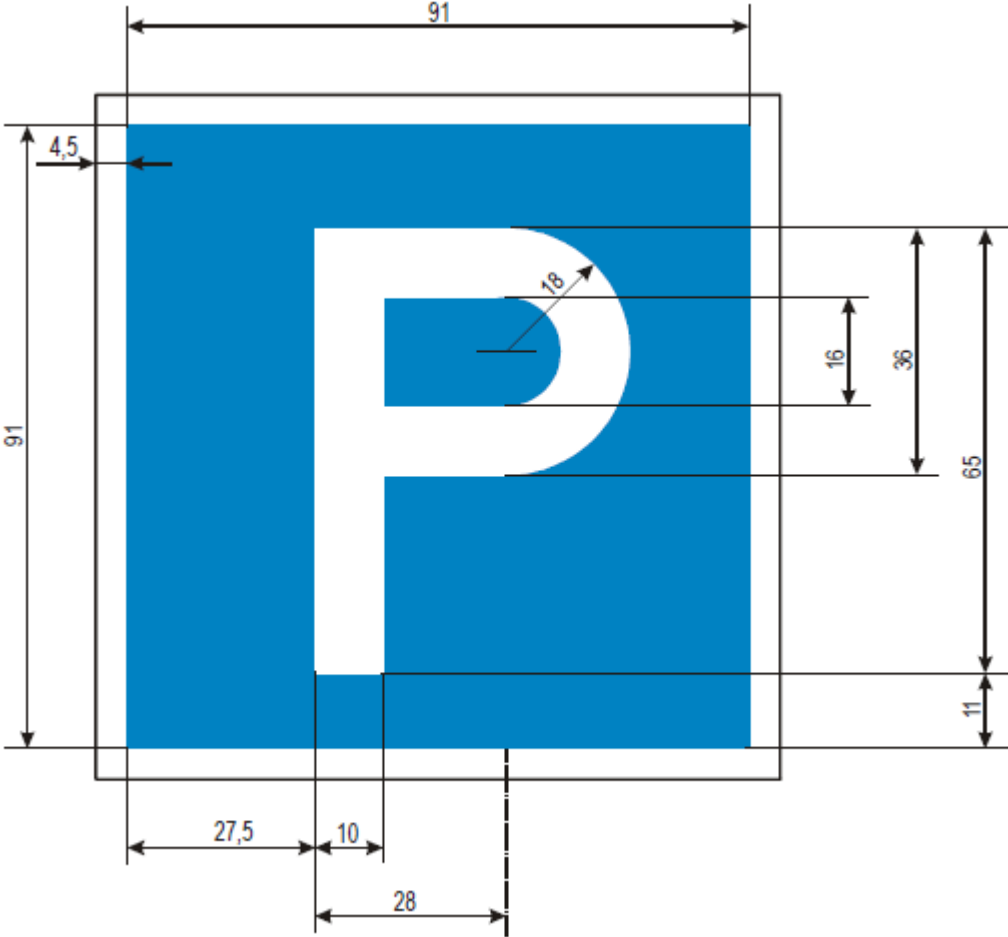

E.5.1

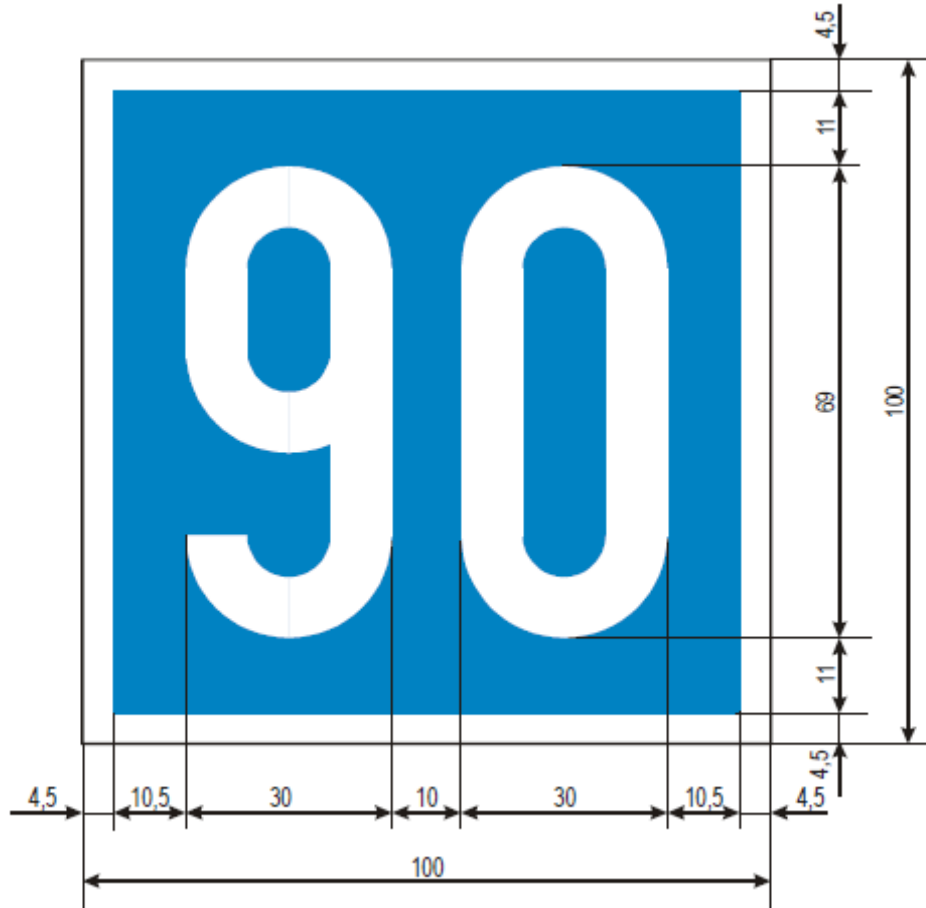

E.5.2

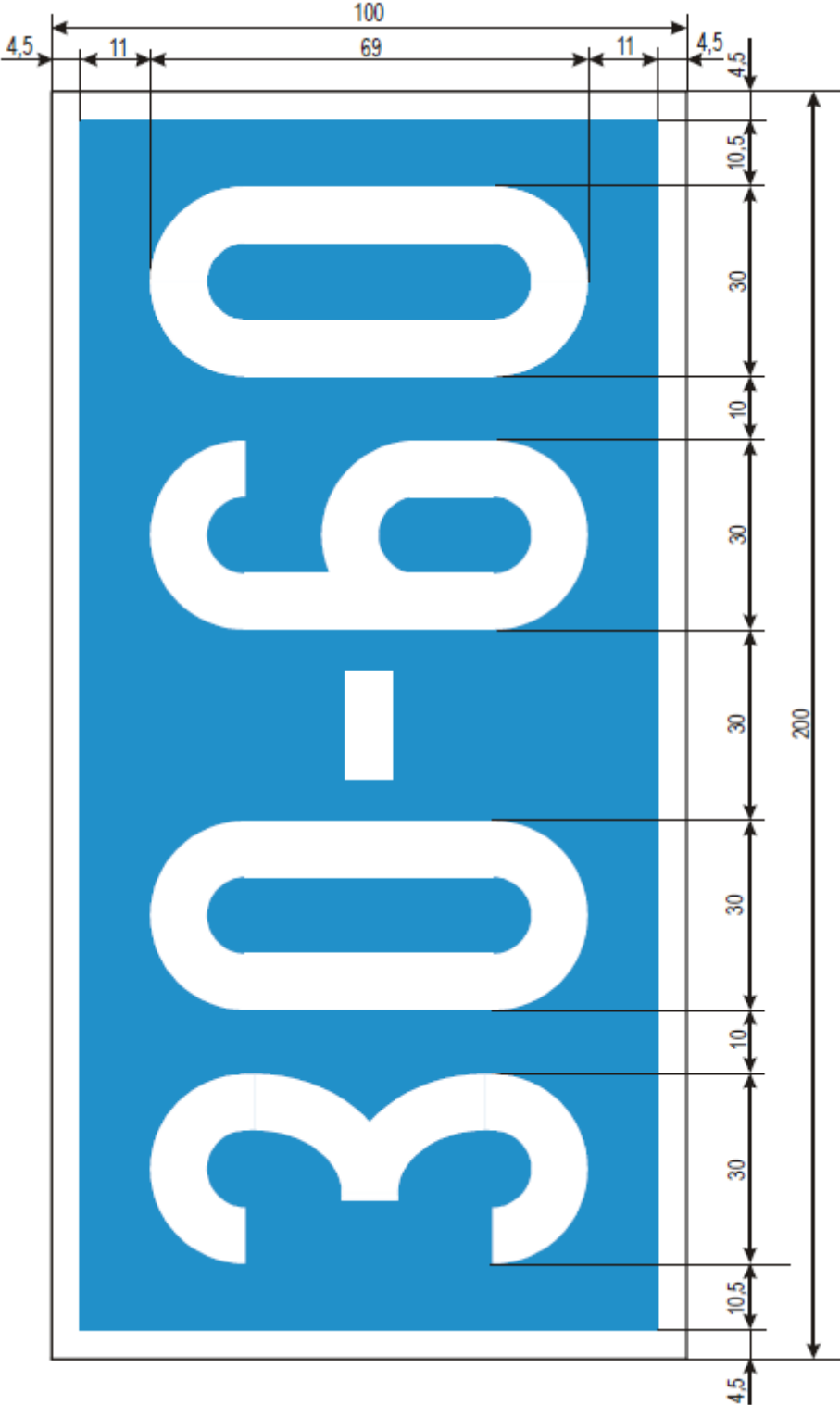

E.5.3

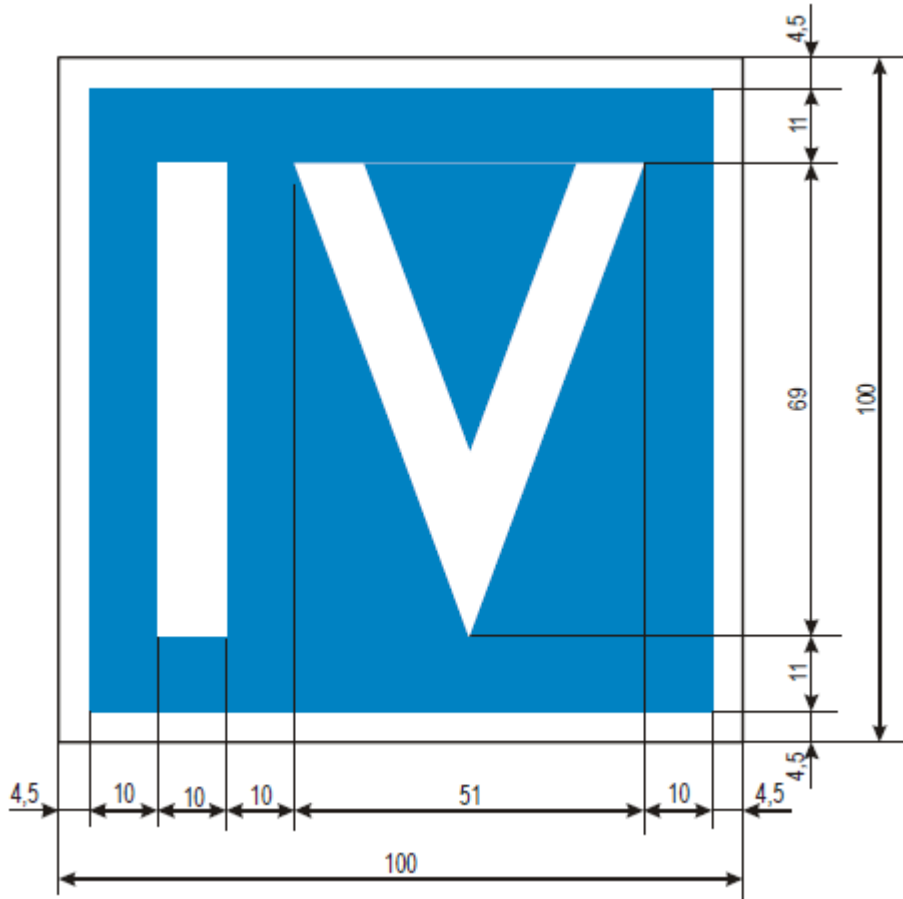

E.5.4

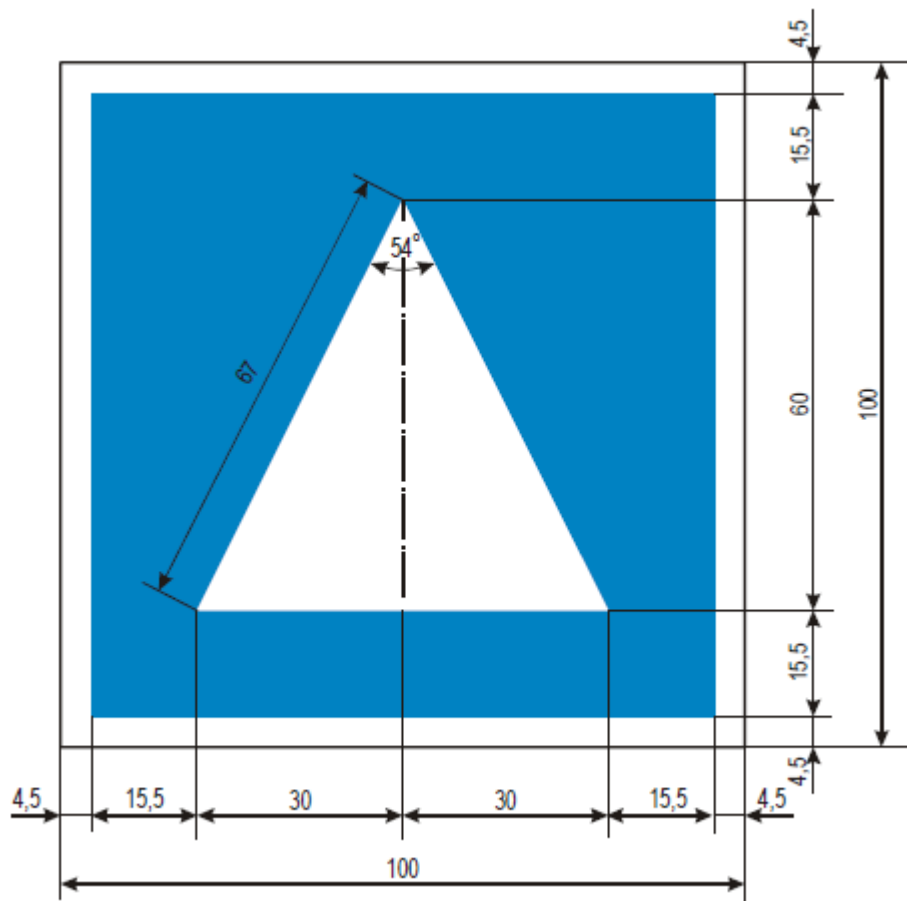

E.5.5

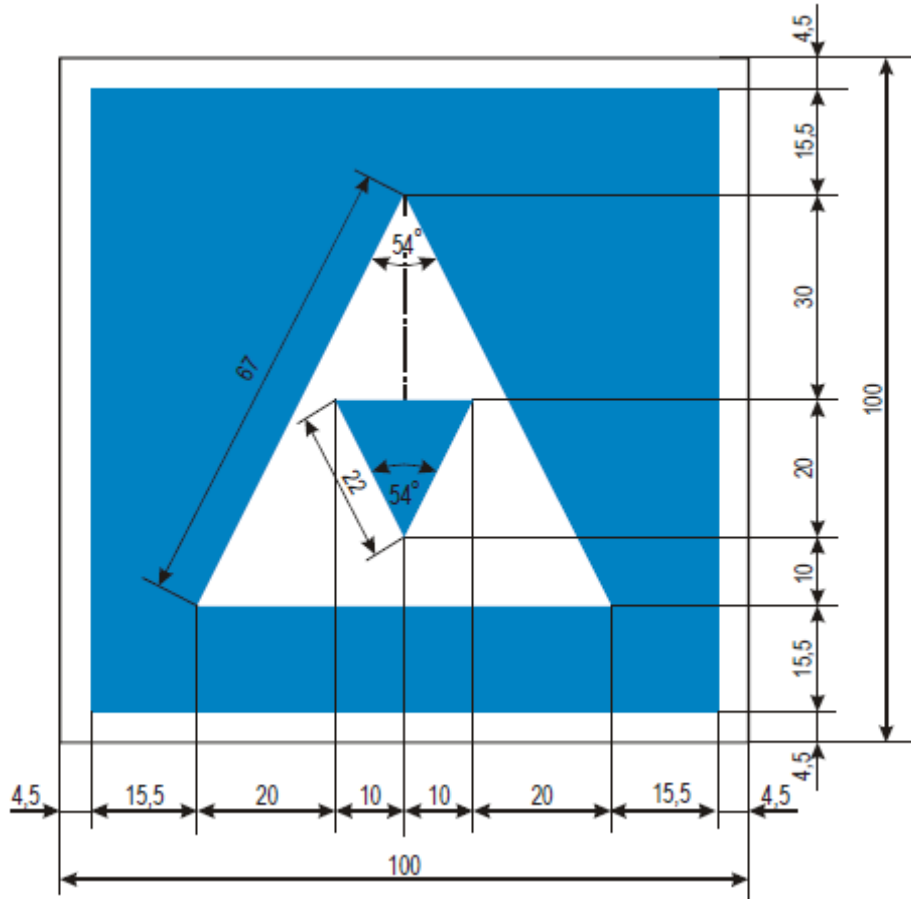

E.5.6

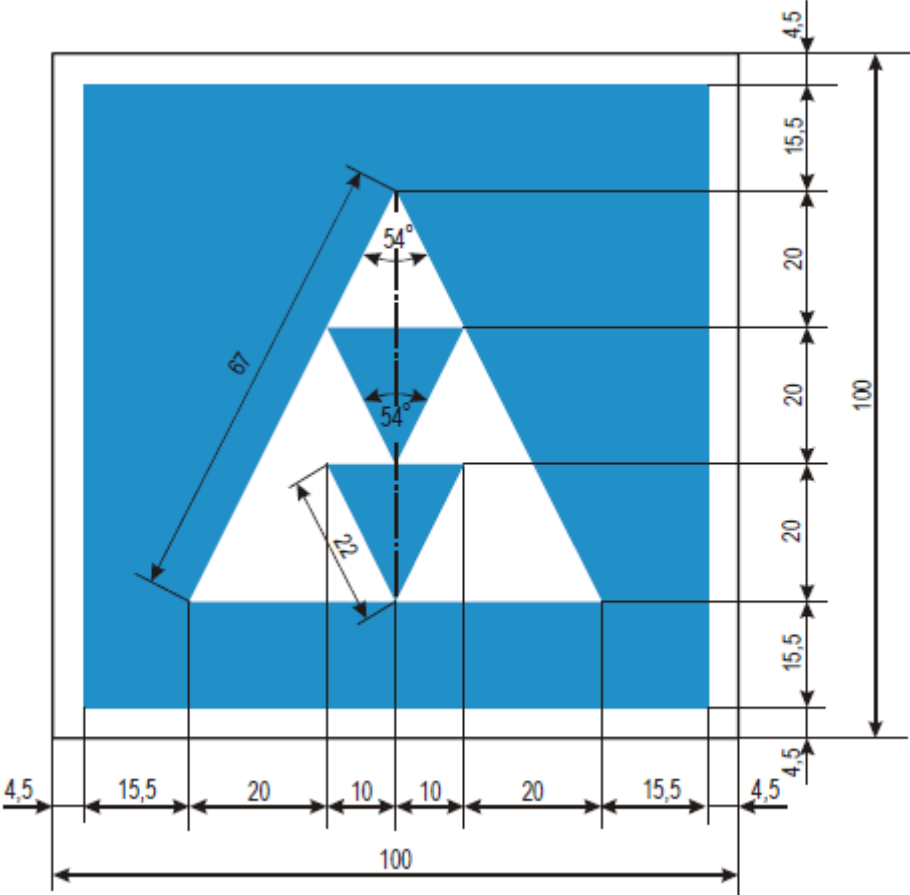

E.5.7

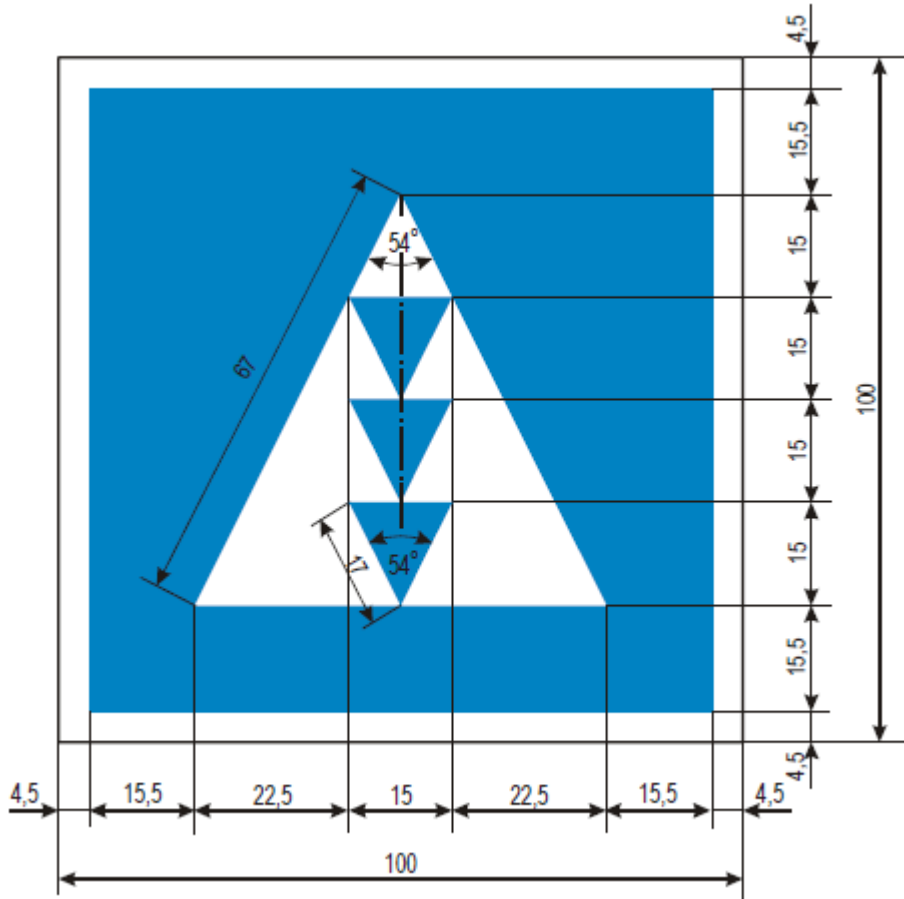

E.5.8

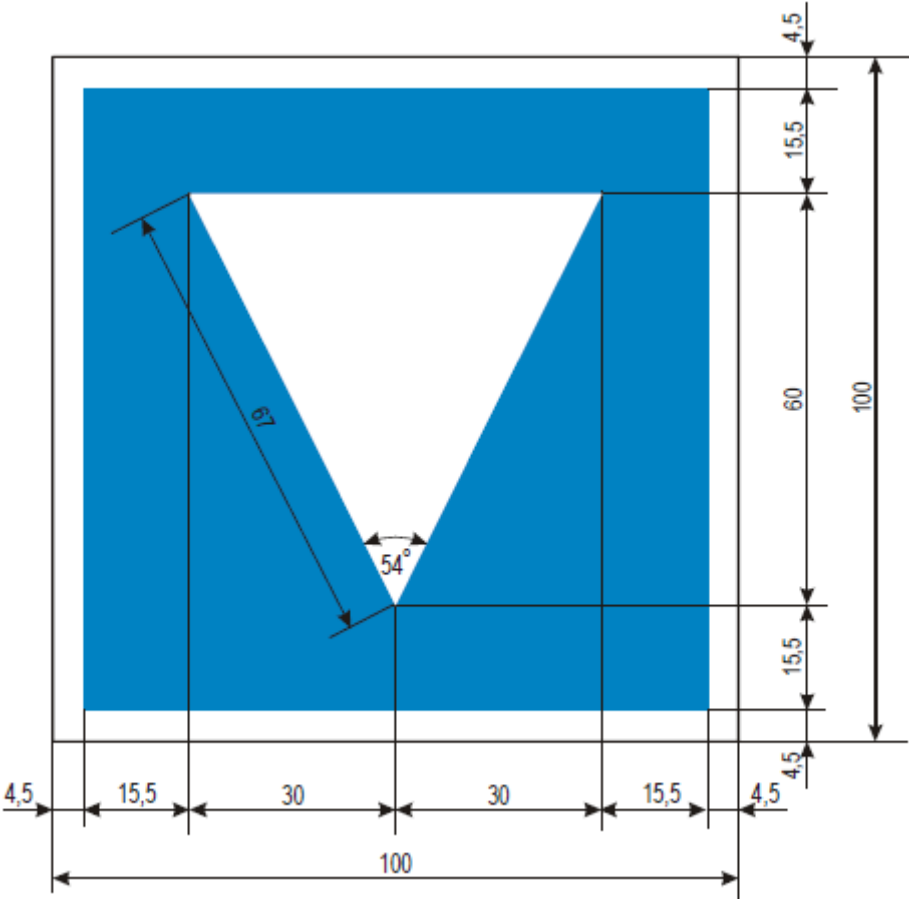

E.5.9

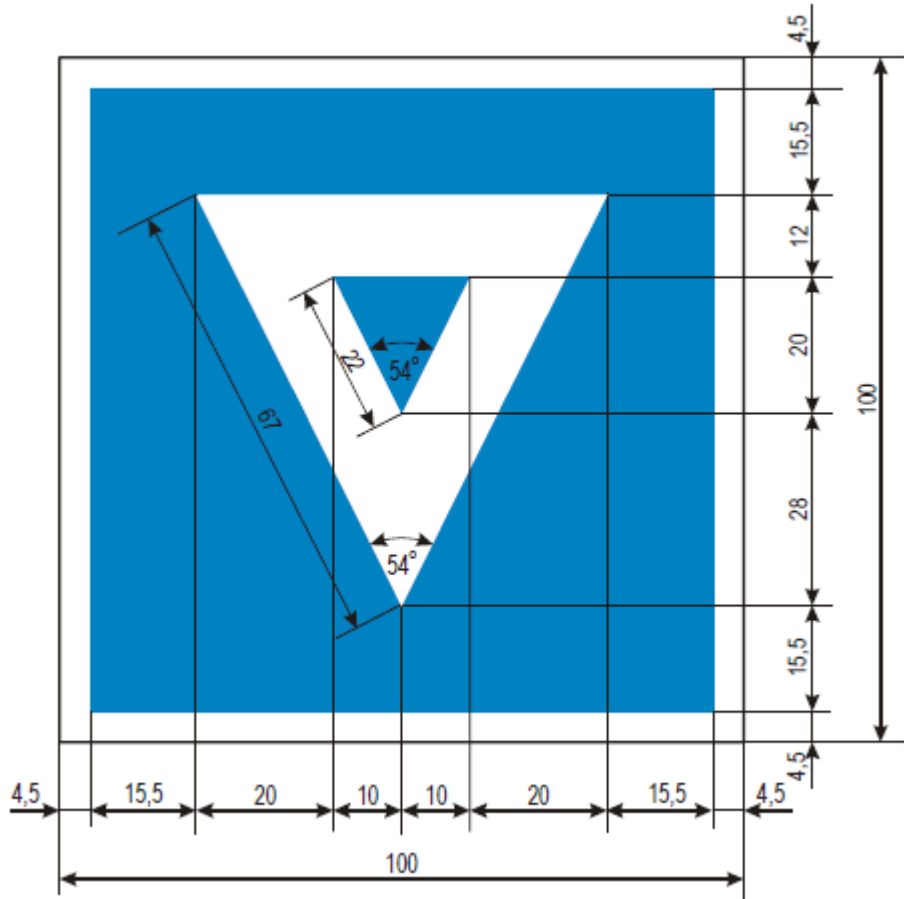

E.5.10

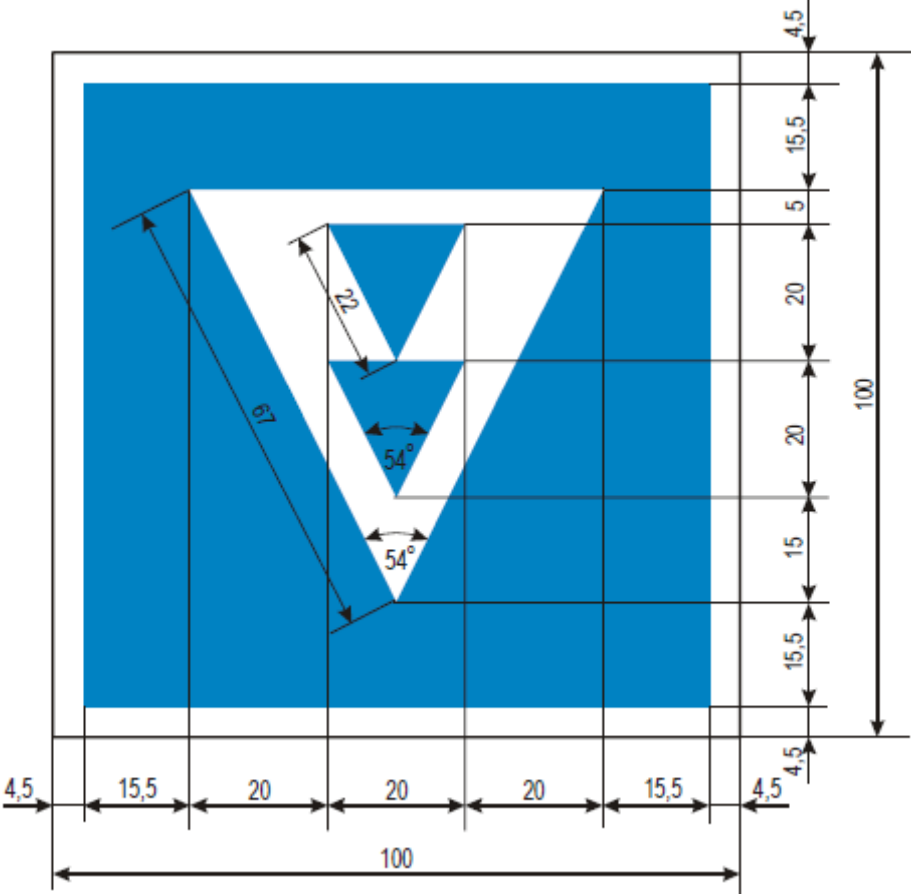

E.5.11

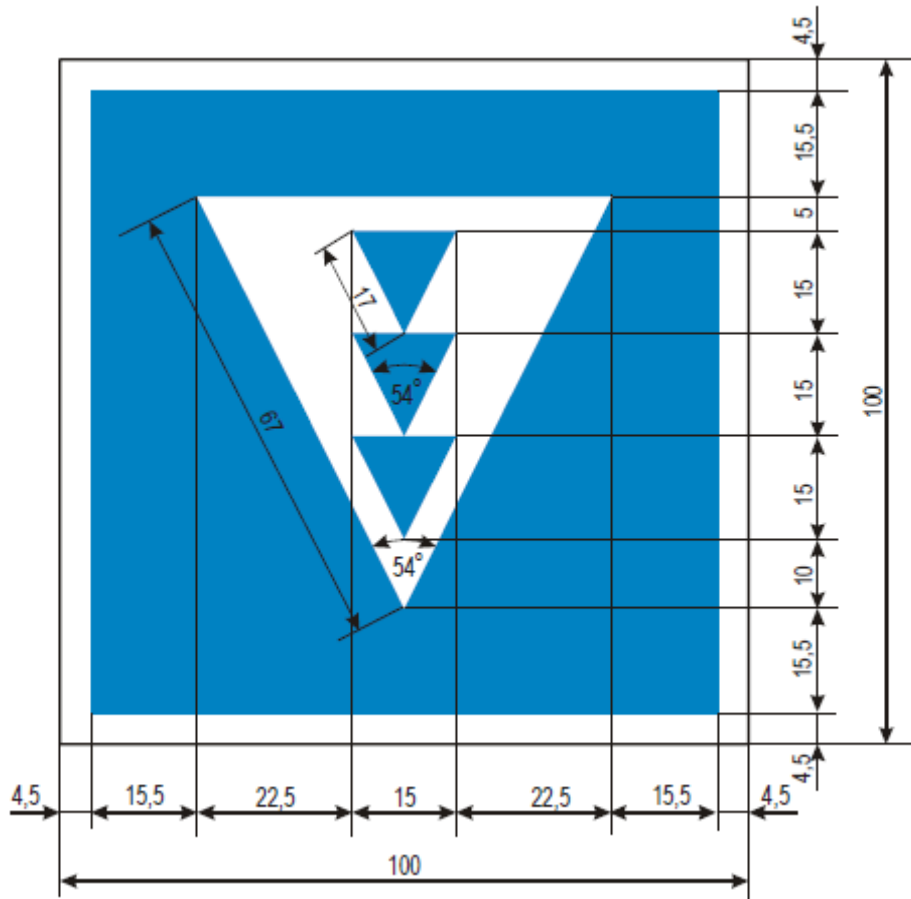

E.5.12

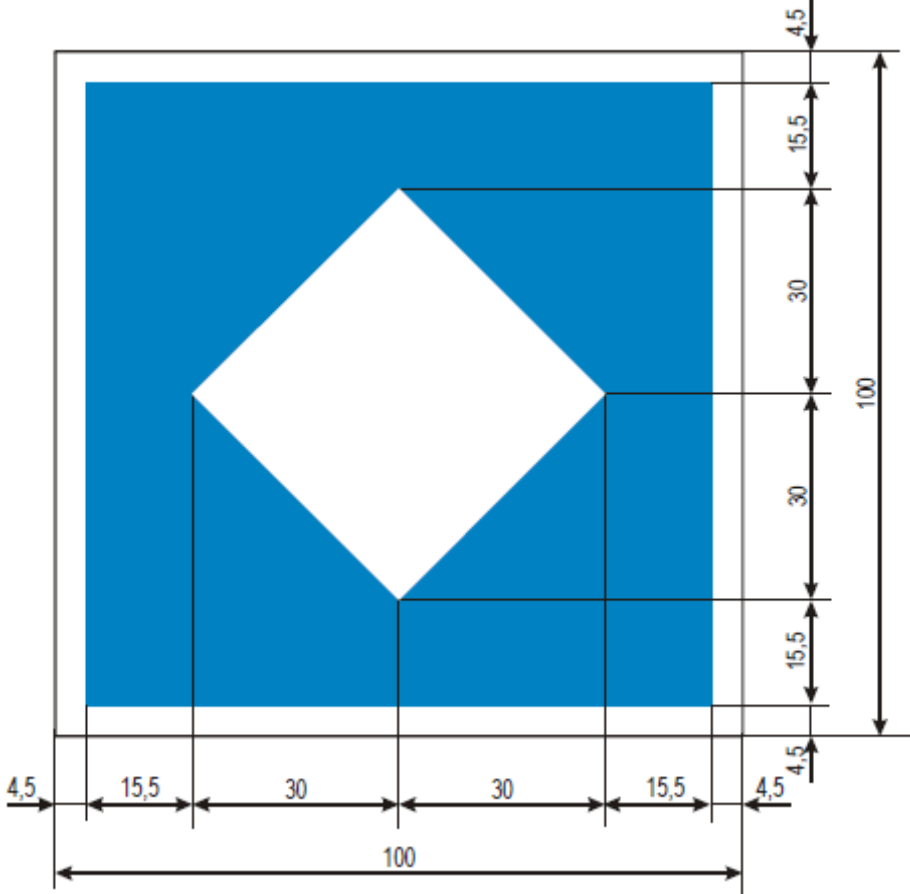

E.5.13

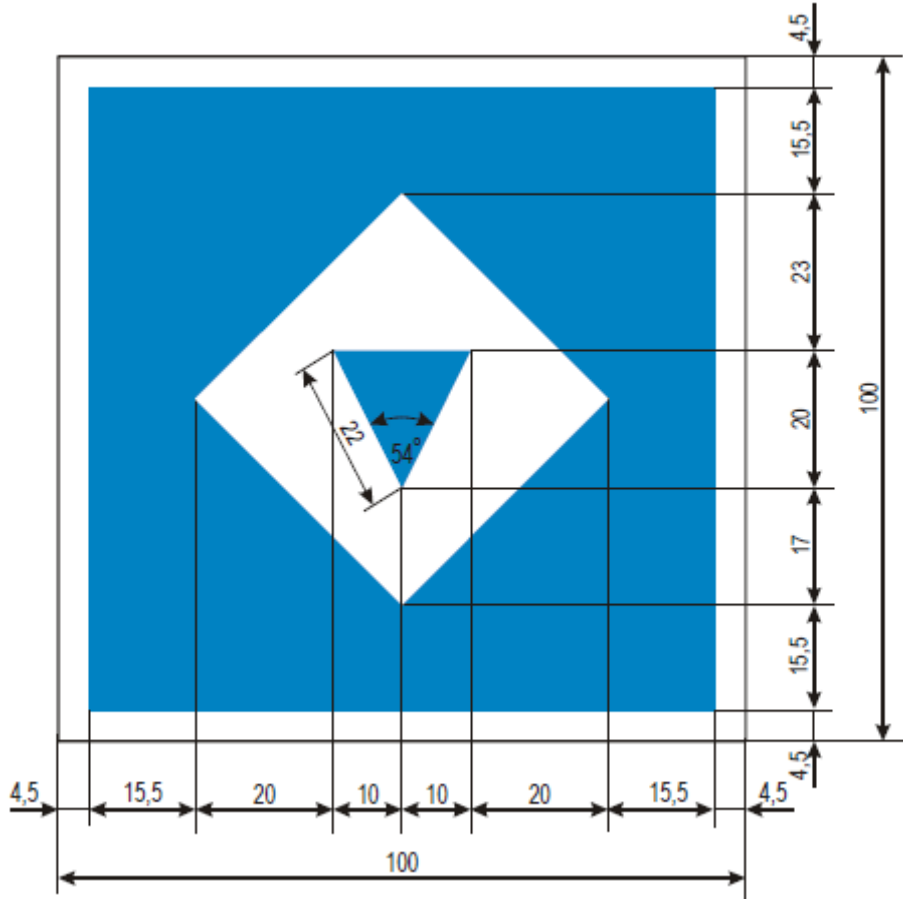

E.5.14

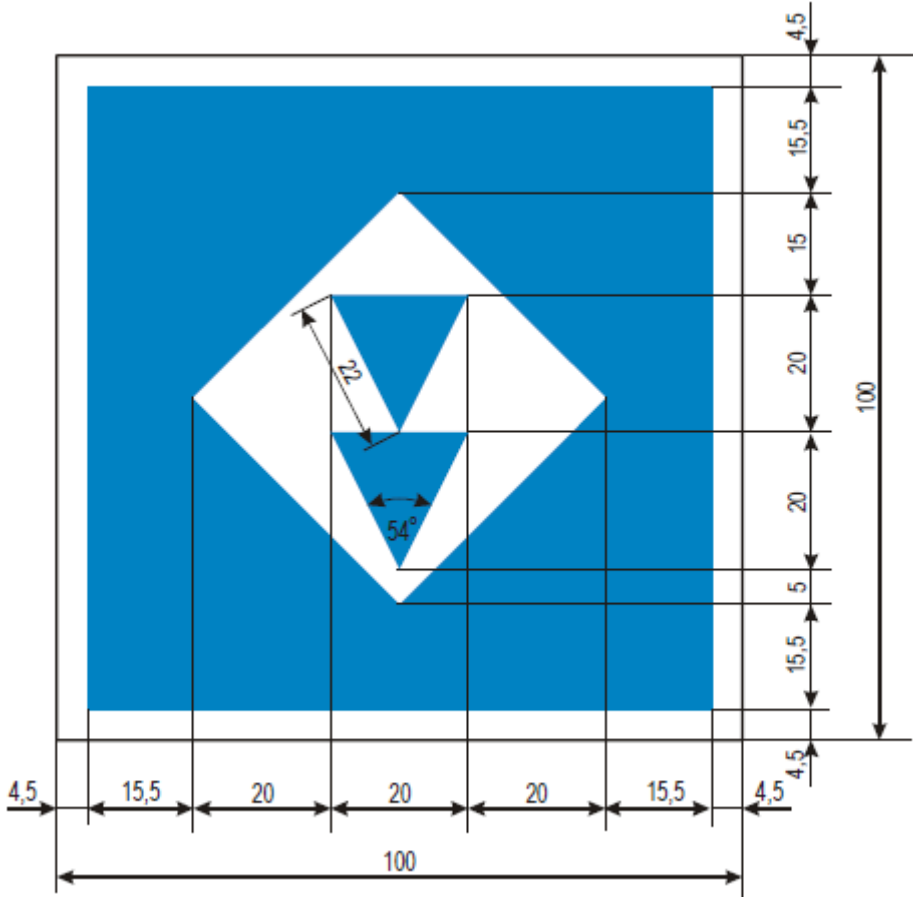

E.5.15

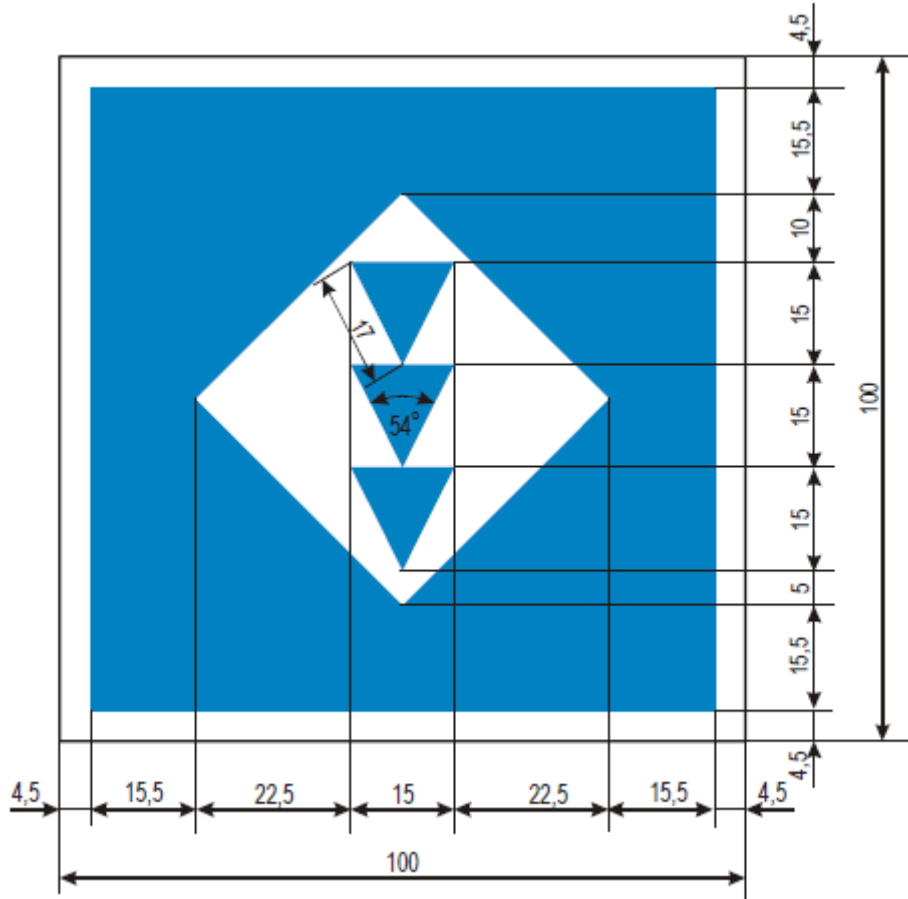

E.6

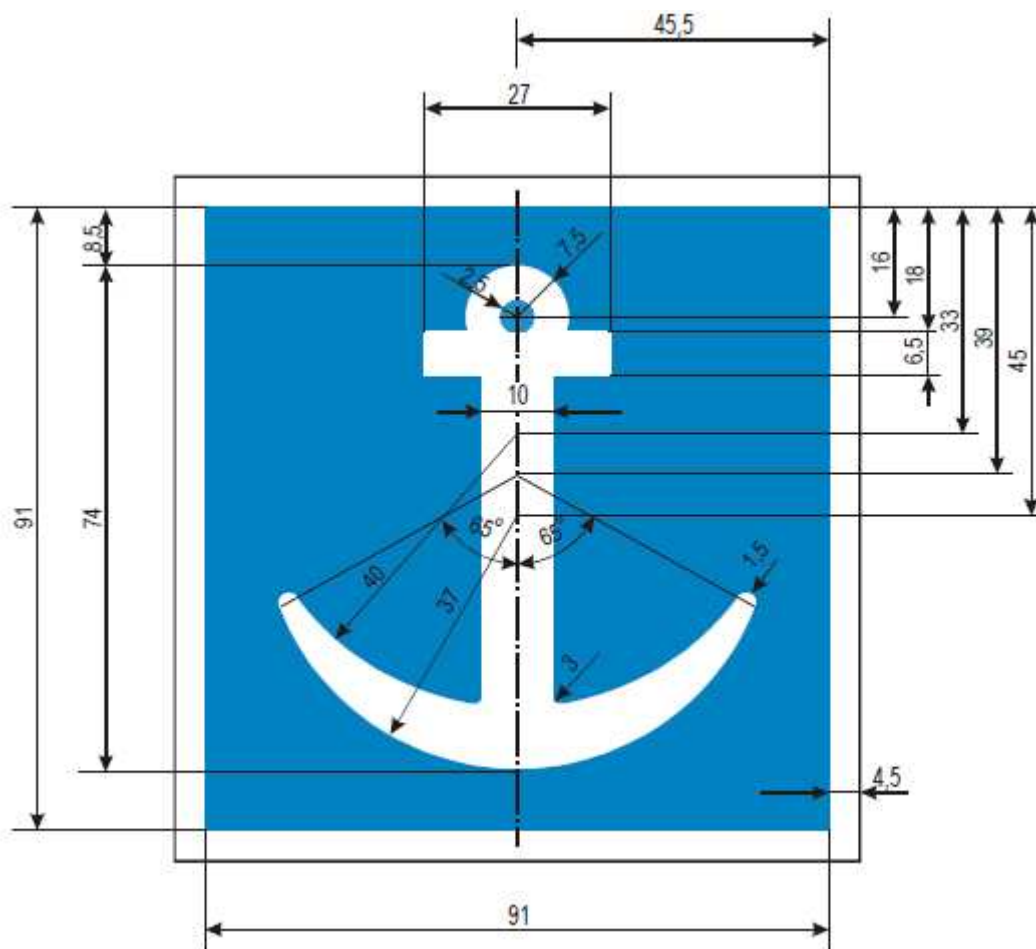

E.7

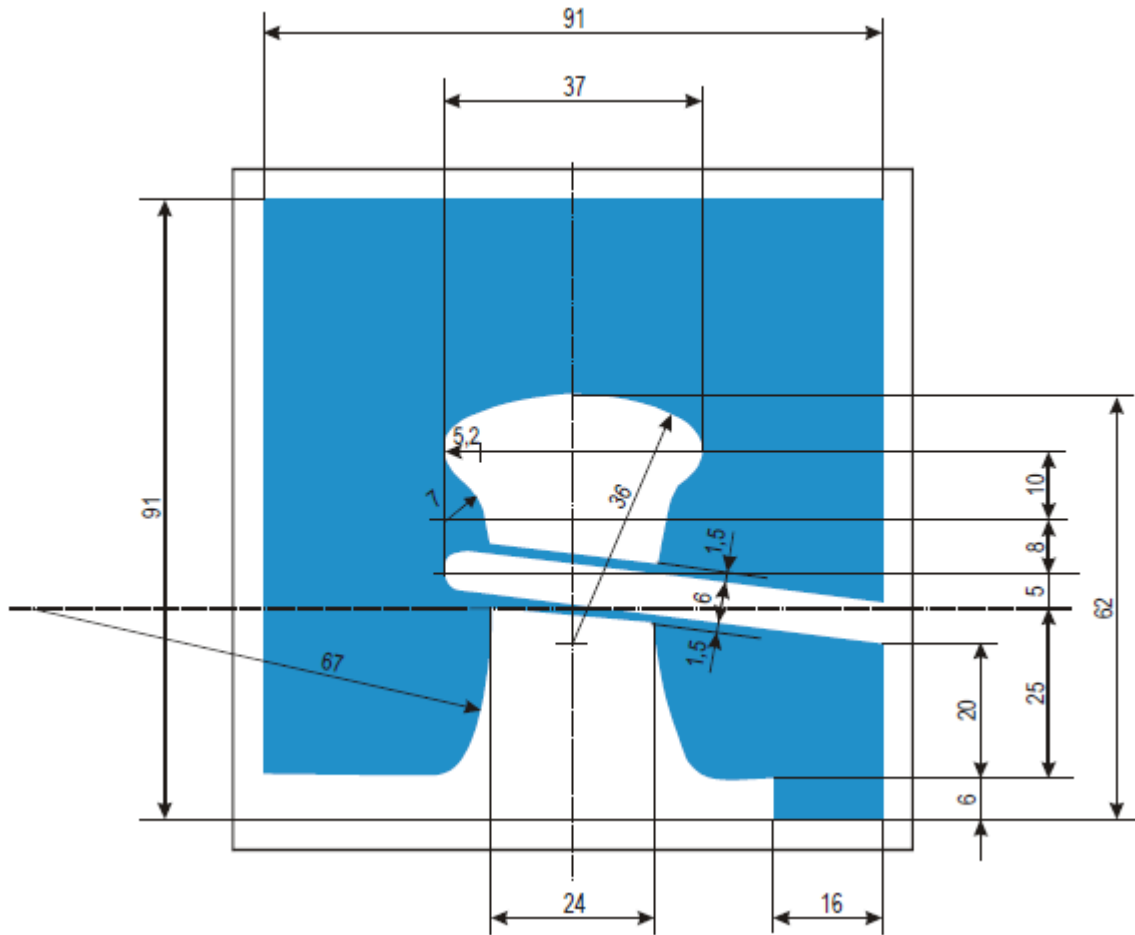

E.7.1

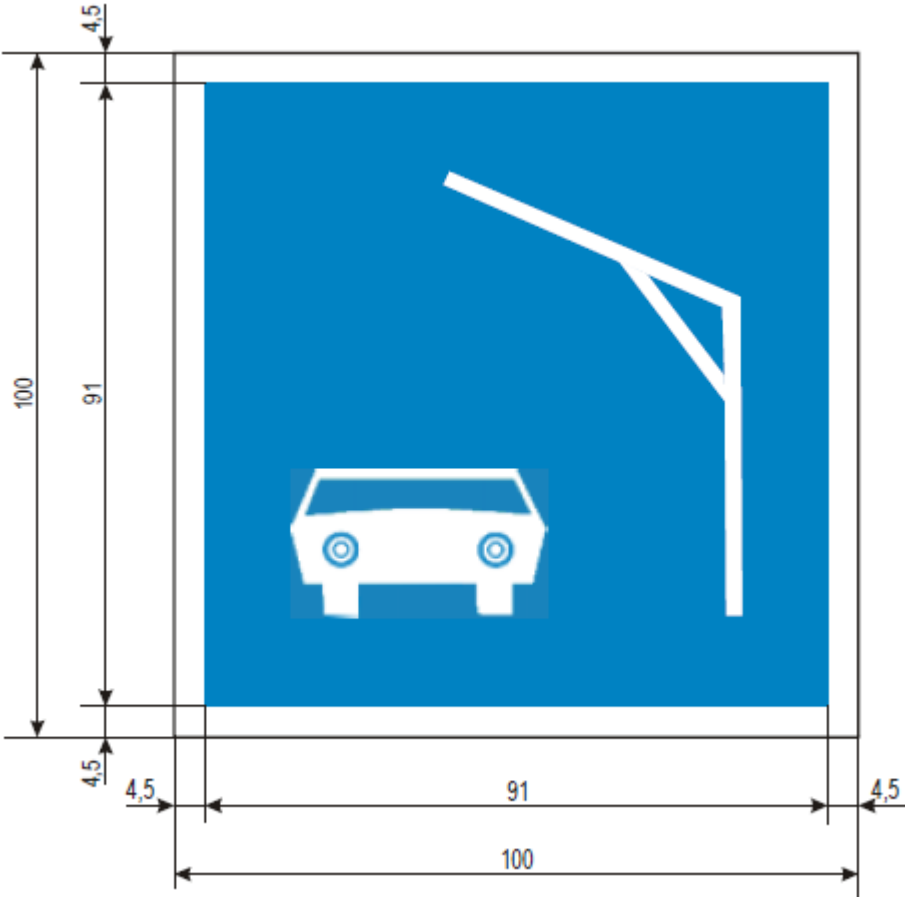

E.8

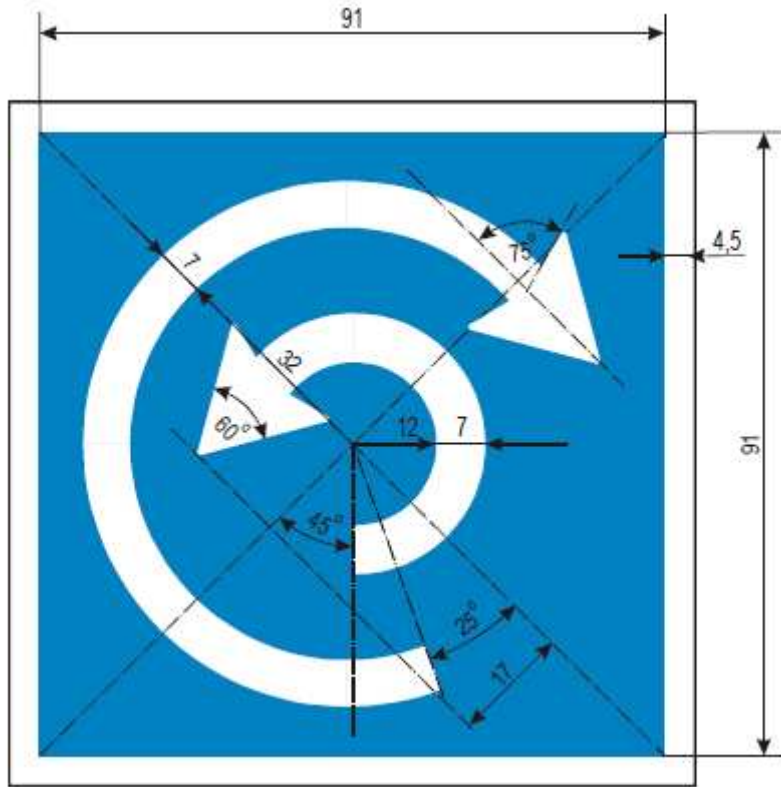

E.9a

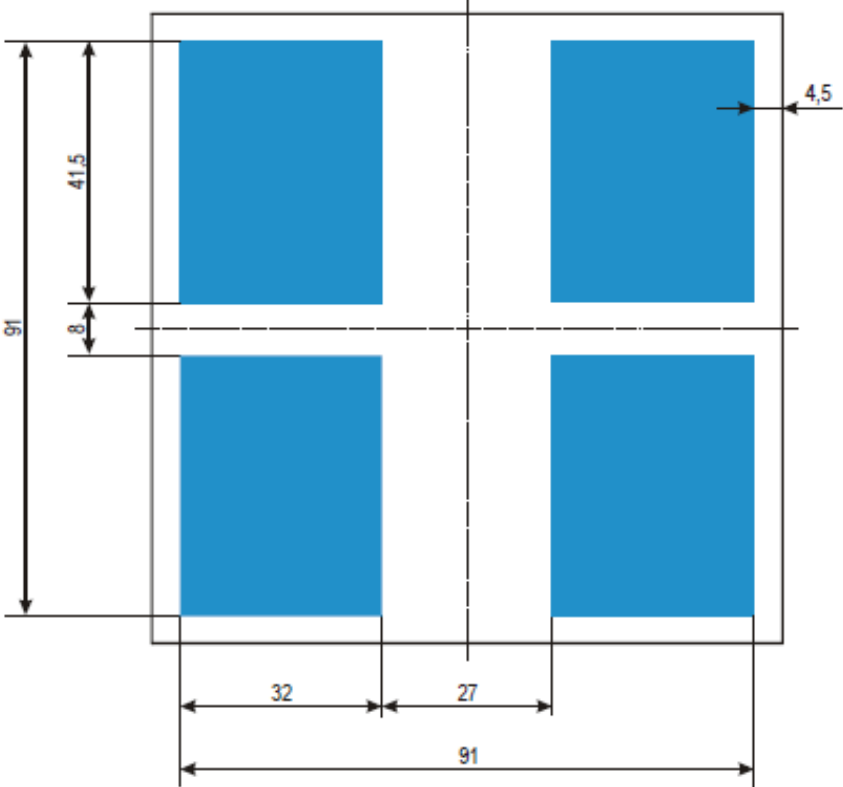

E.9b

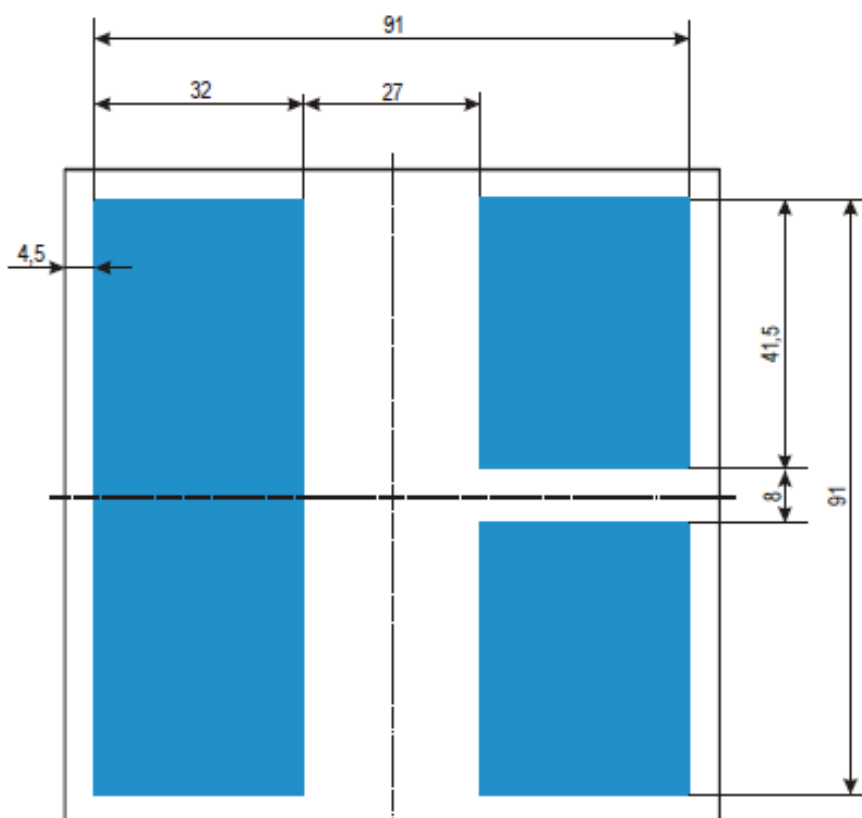

E.10a

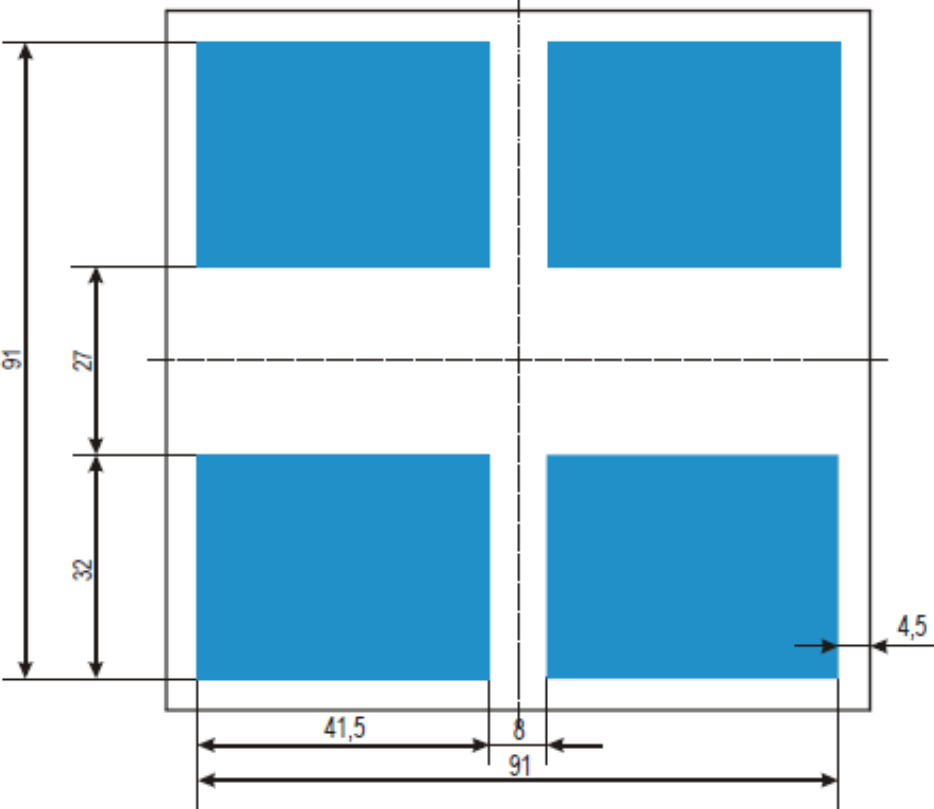

E.10b

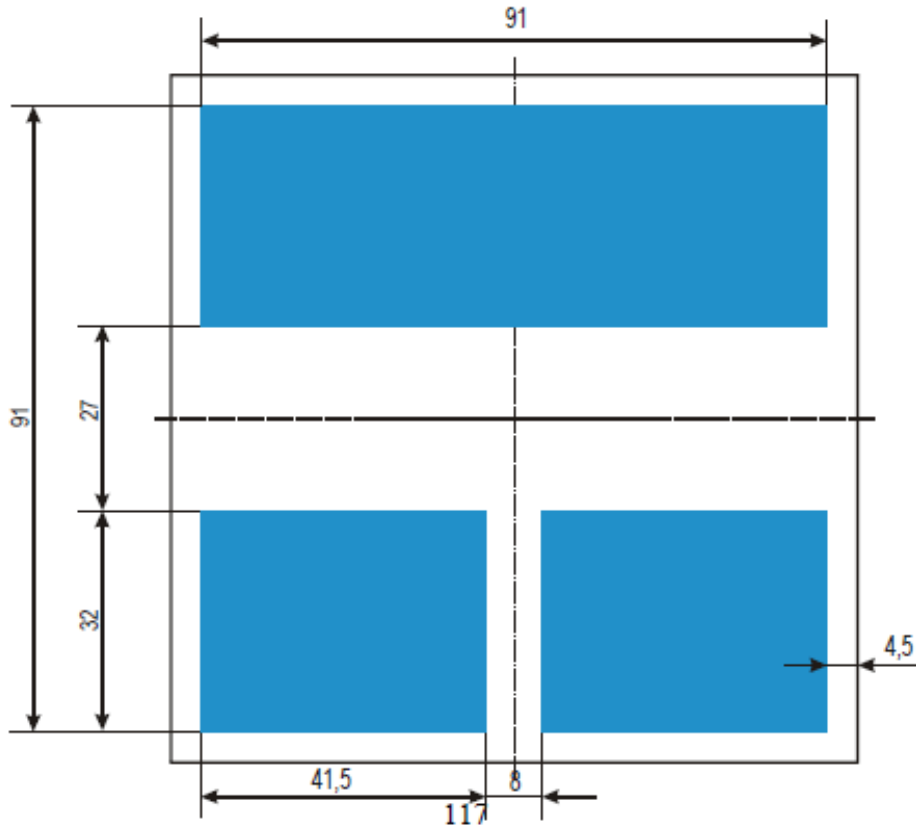

E.11a

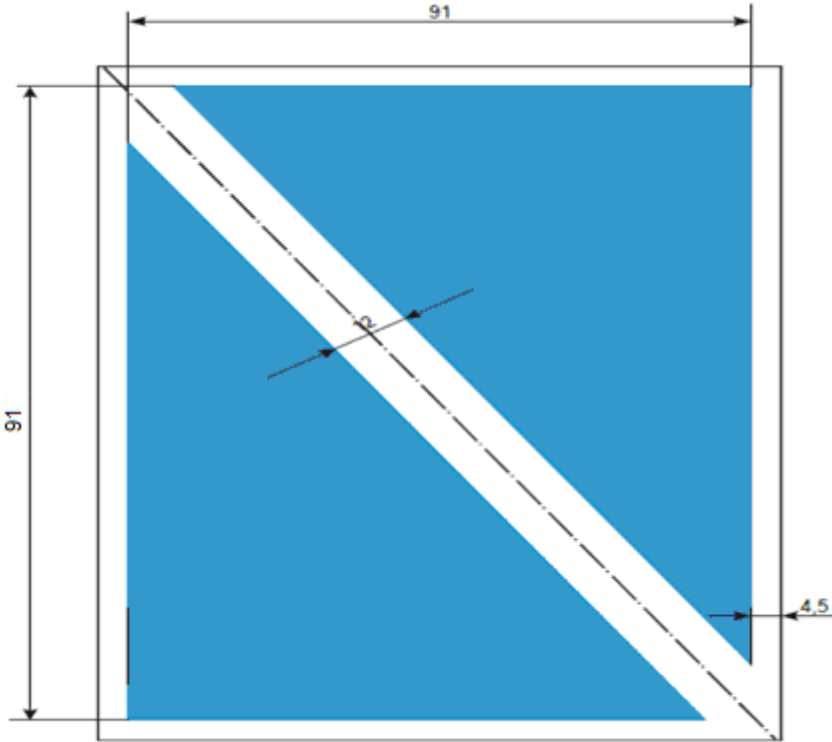

E.11b

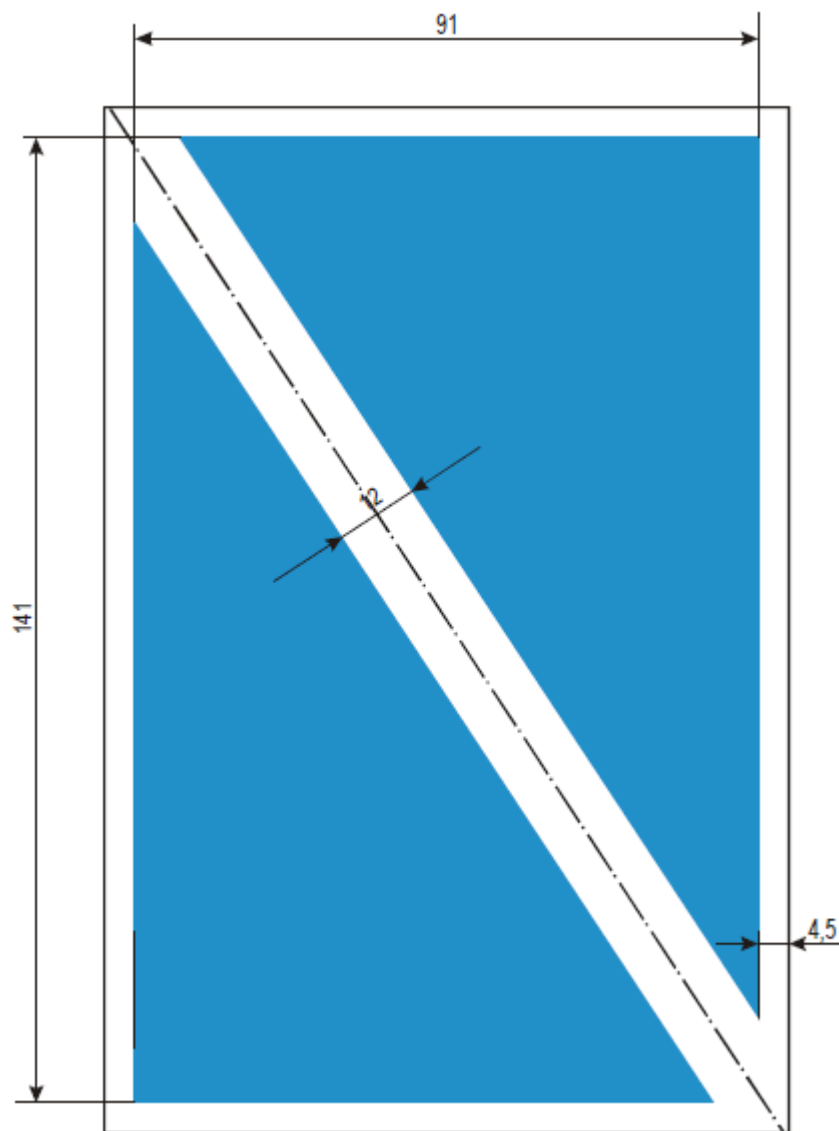

E.13

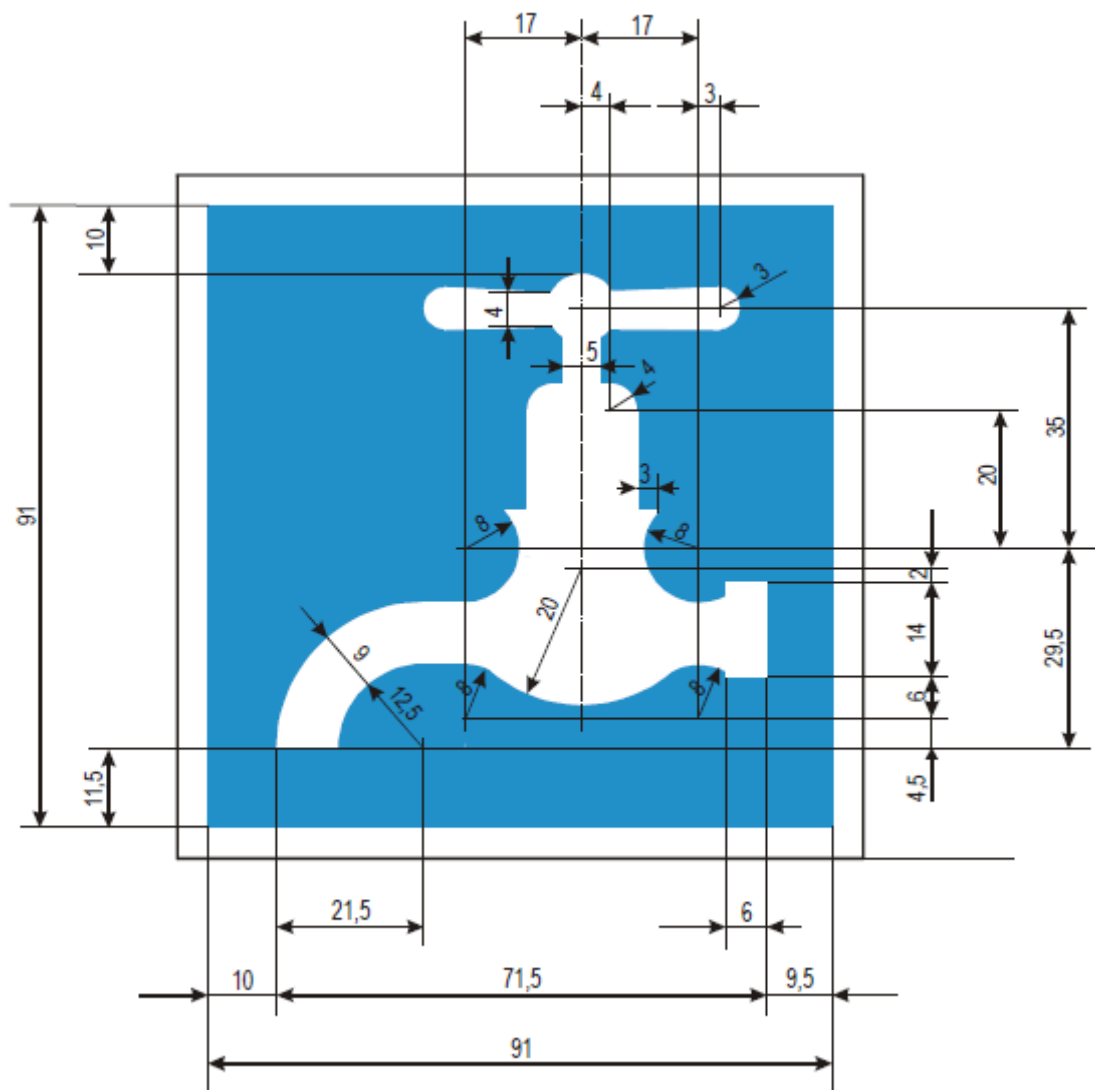

E.14

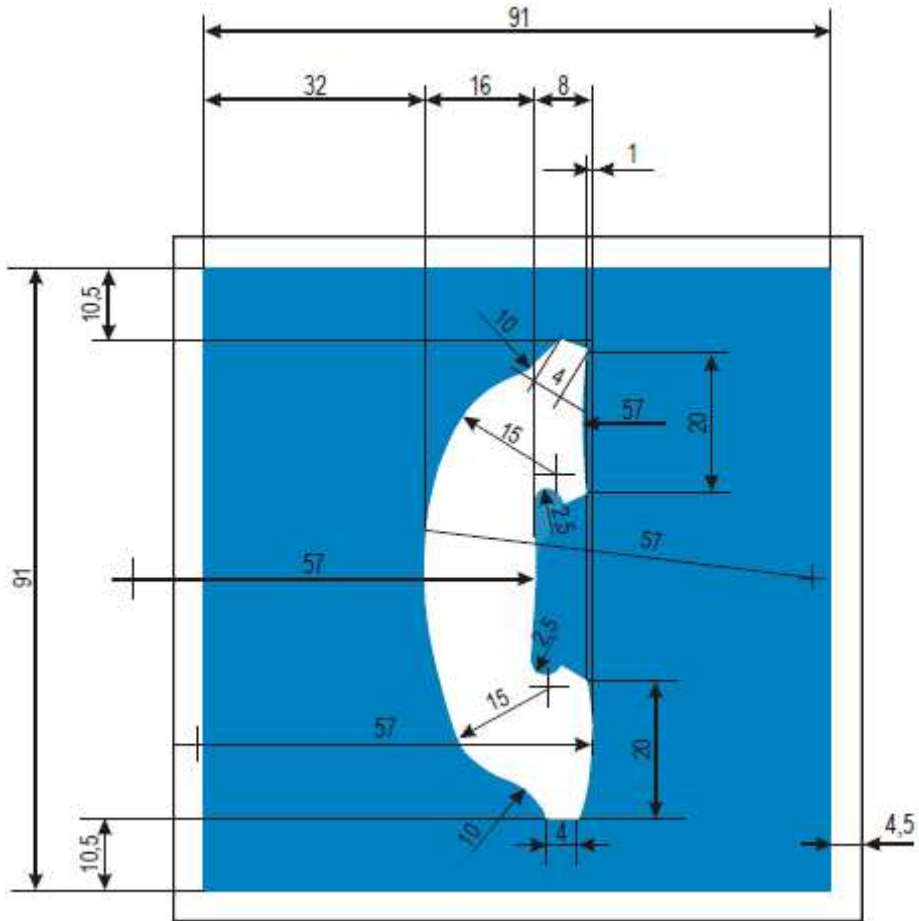

E.15

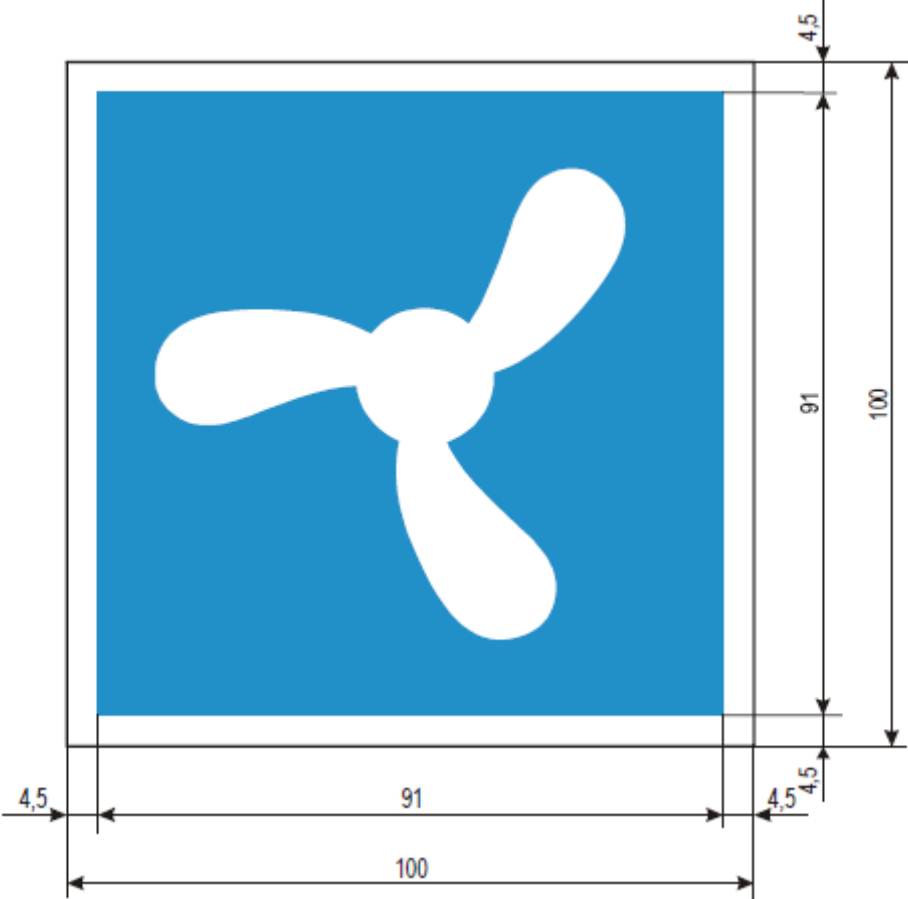

E.16

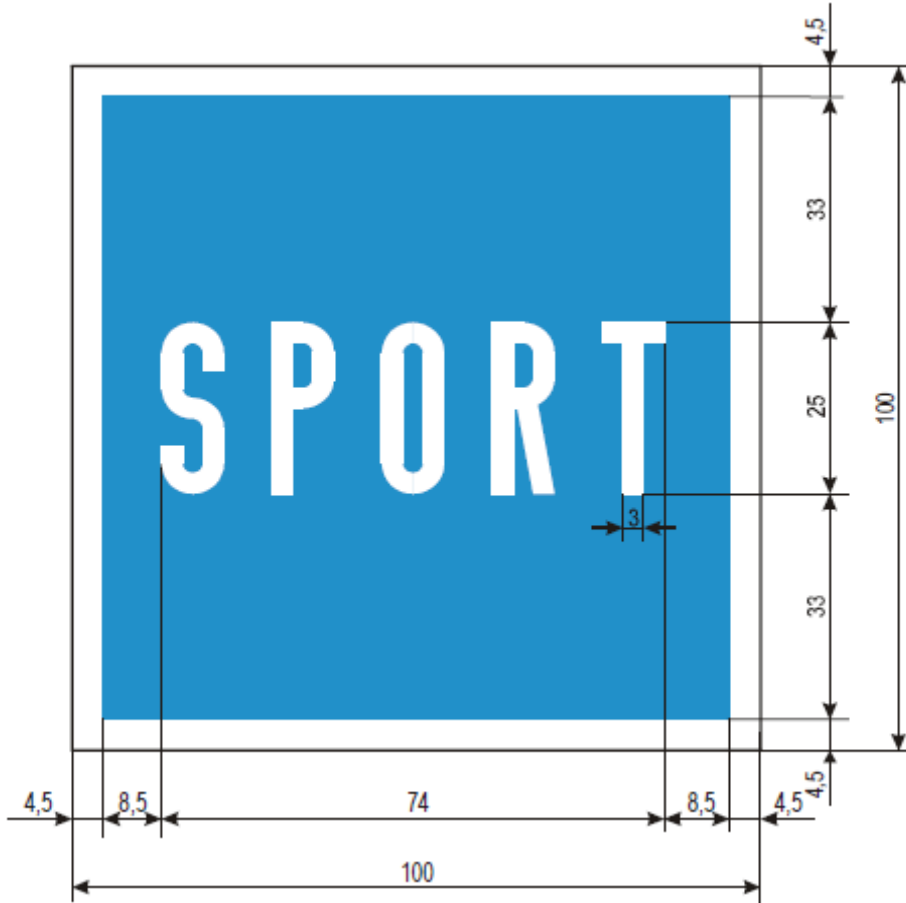

E.17

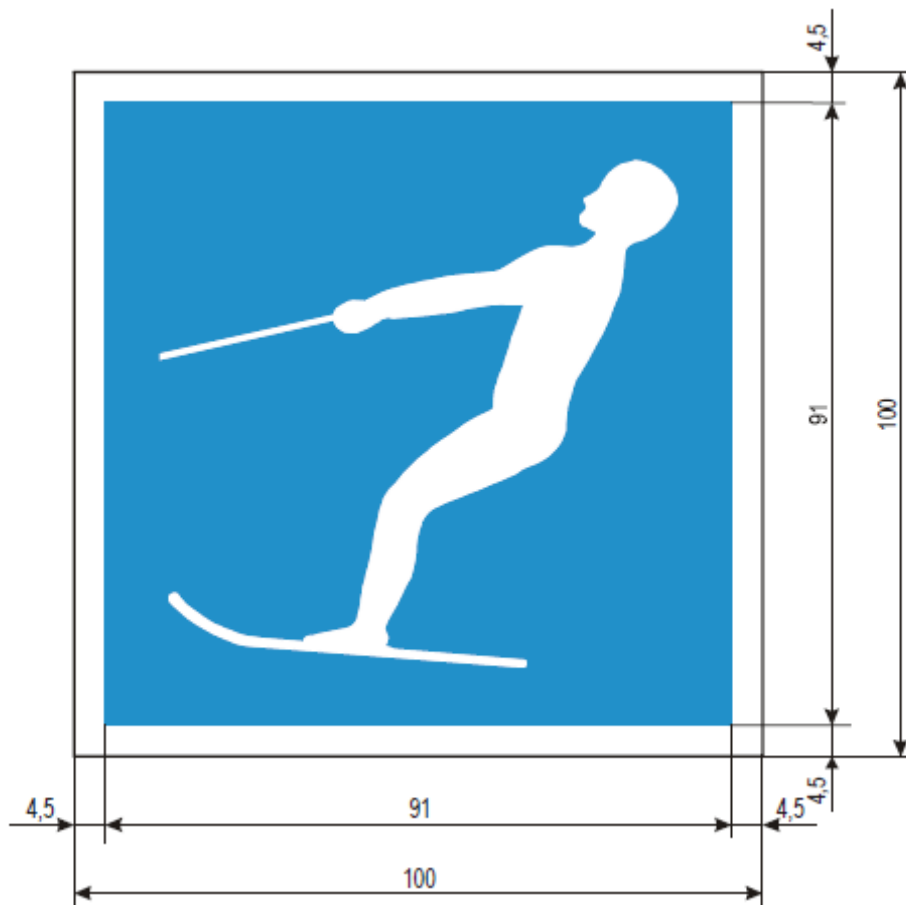

E.18

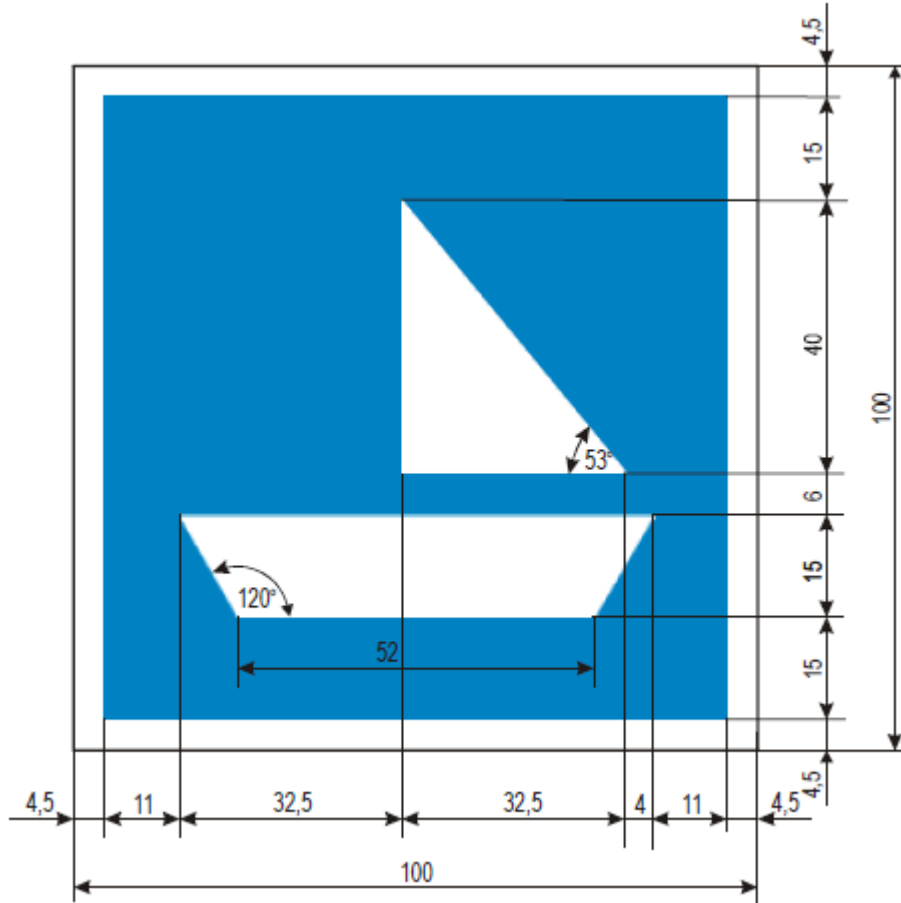

E.19

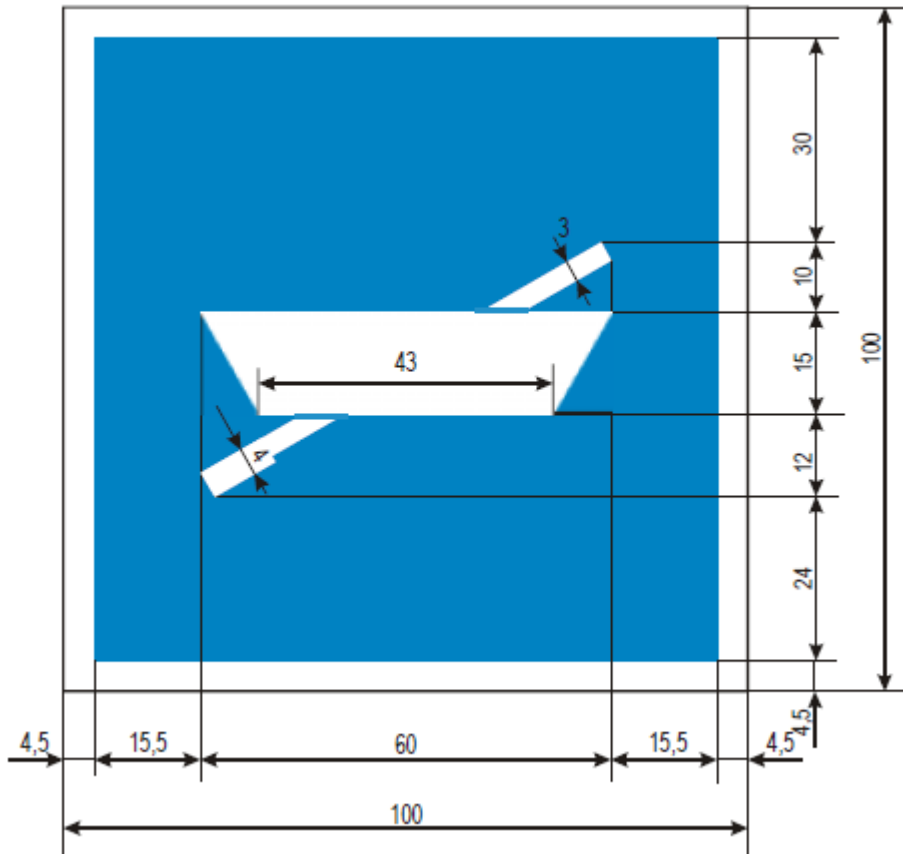

E.20

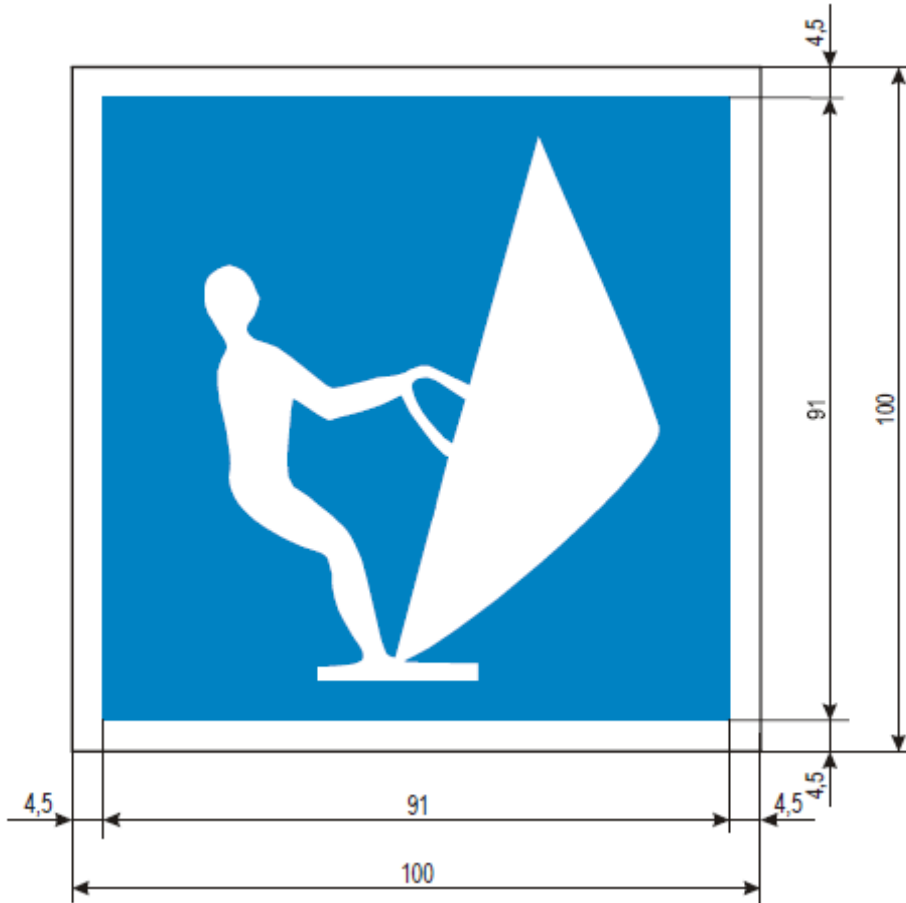

E.21

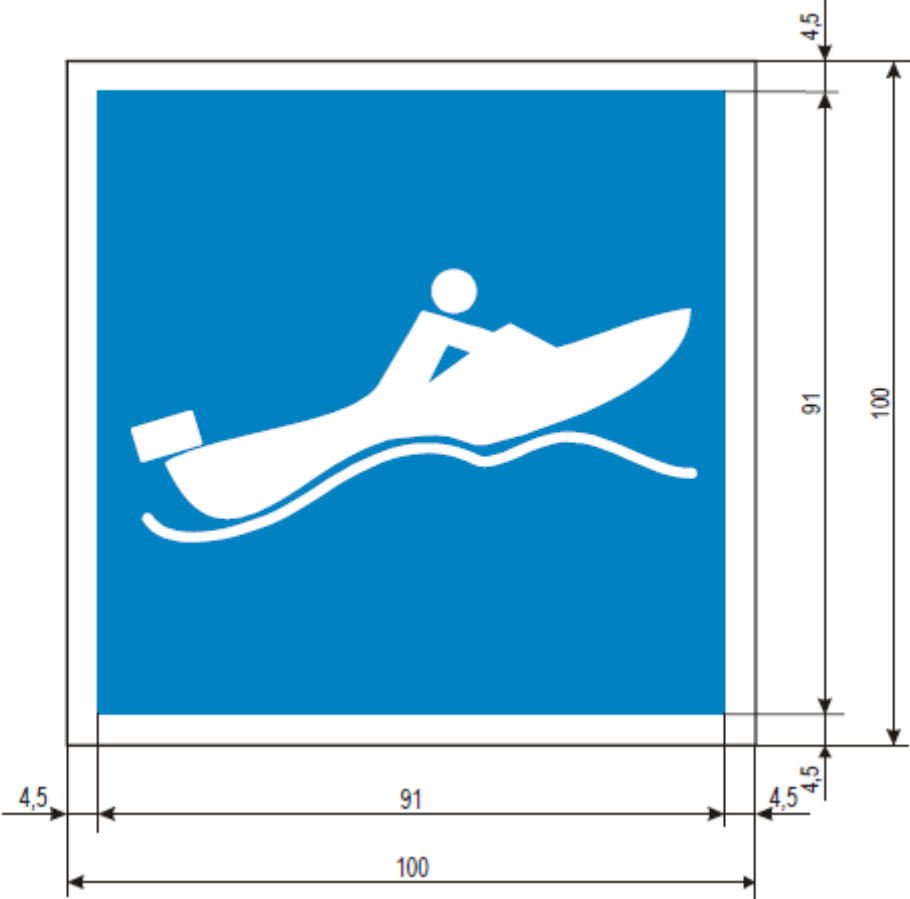

E.22

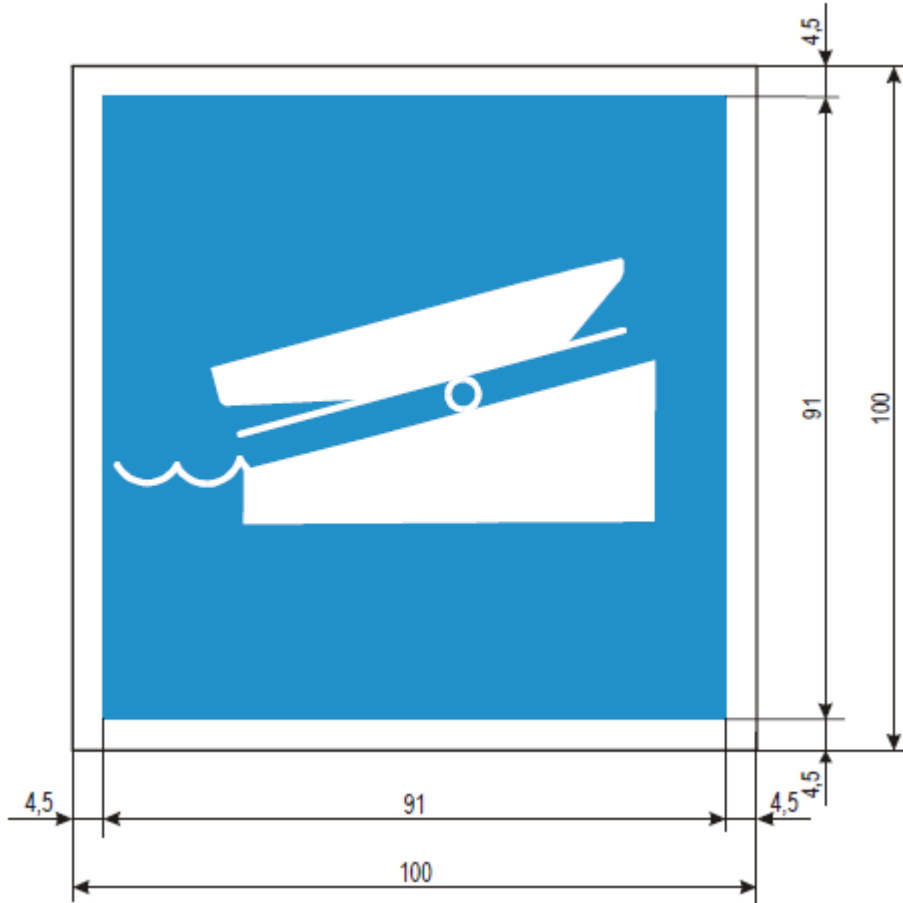

E.23

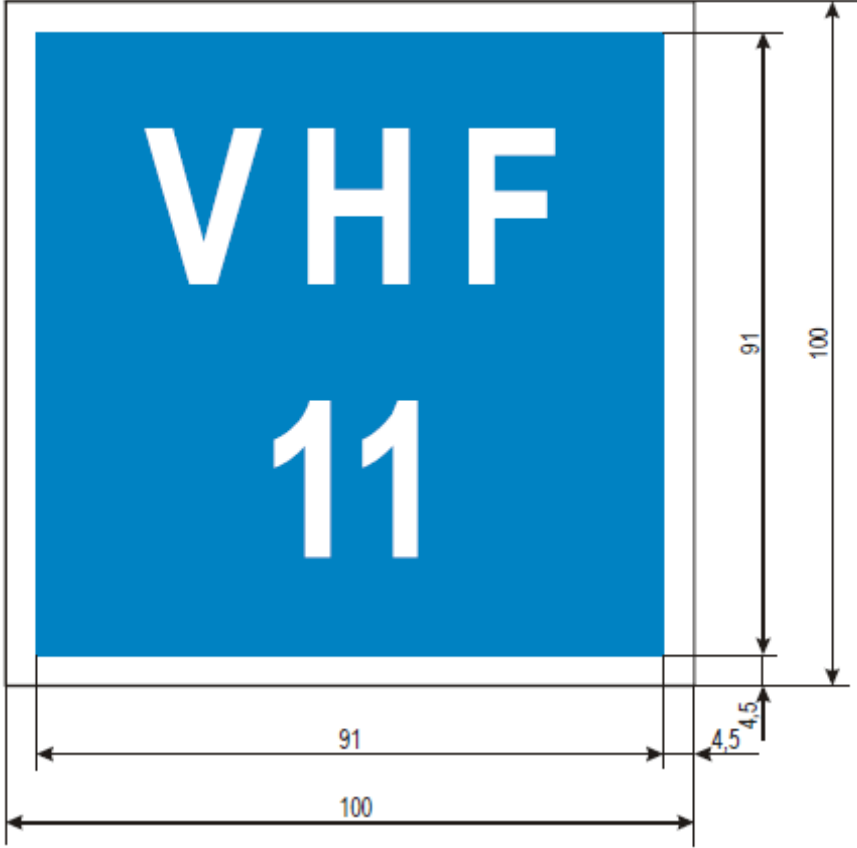

E.24

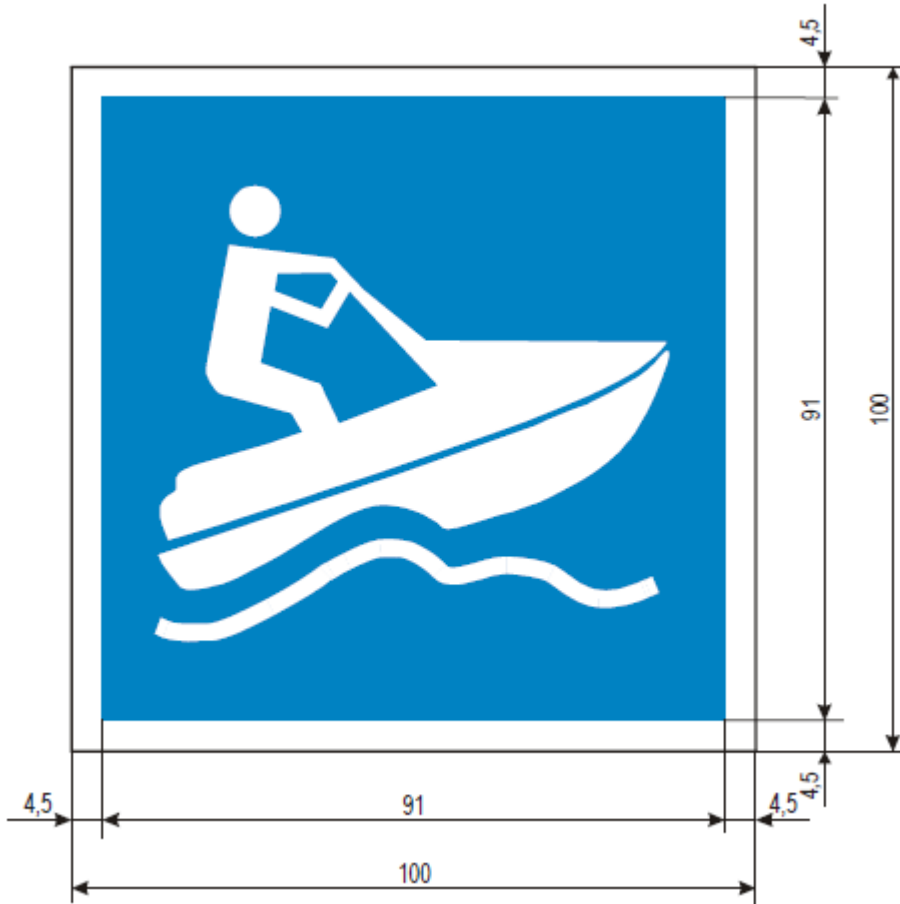

Section II.1

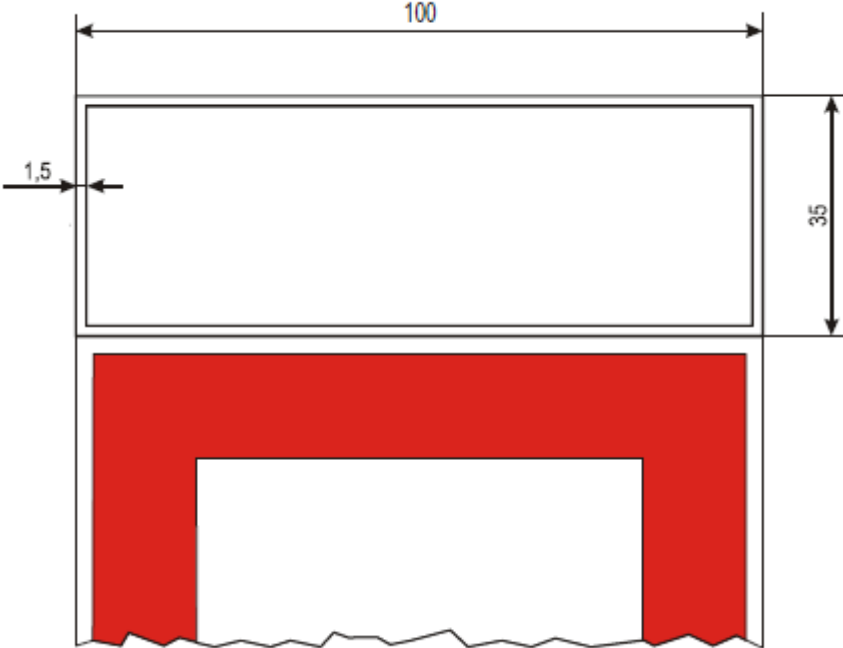

Section II.1

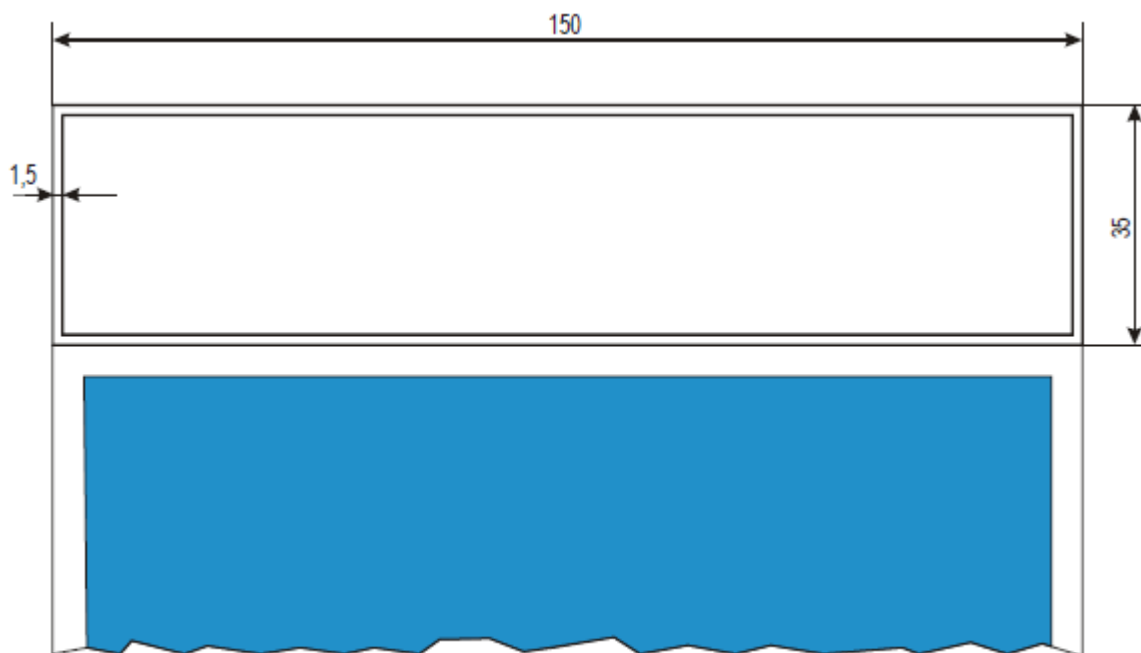

Section II.3

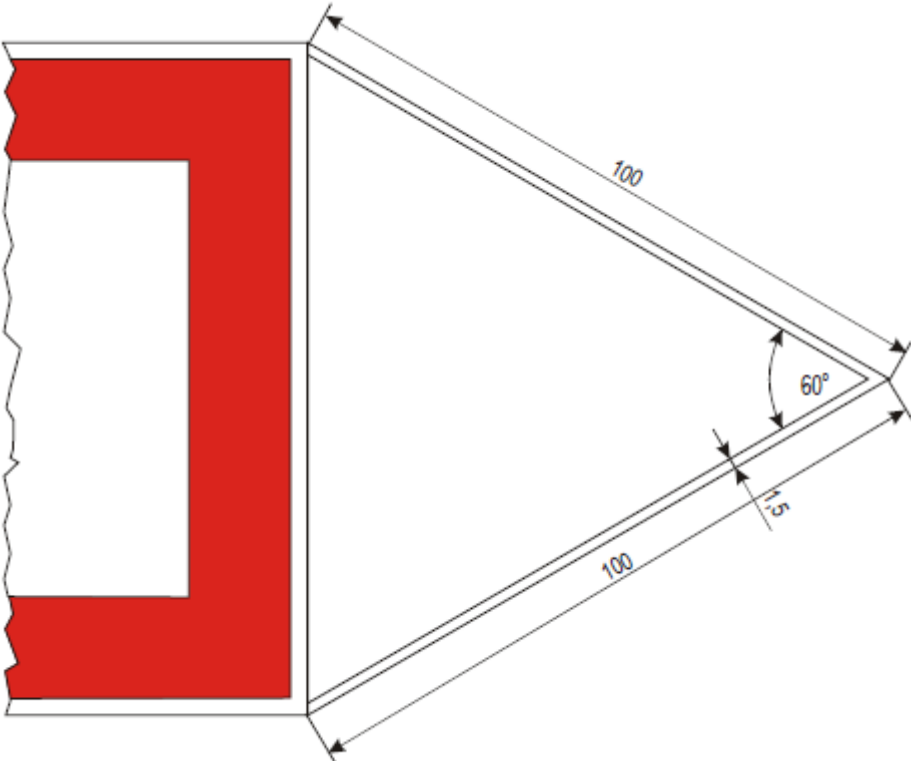

Section II.4

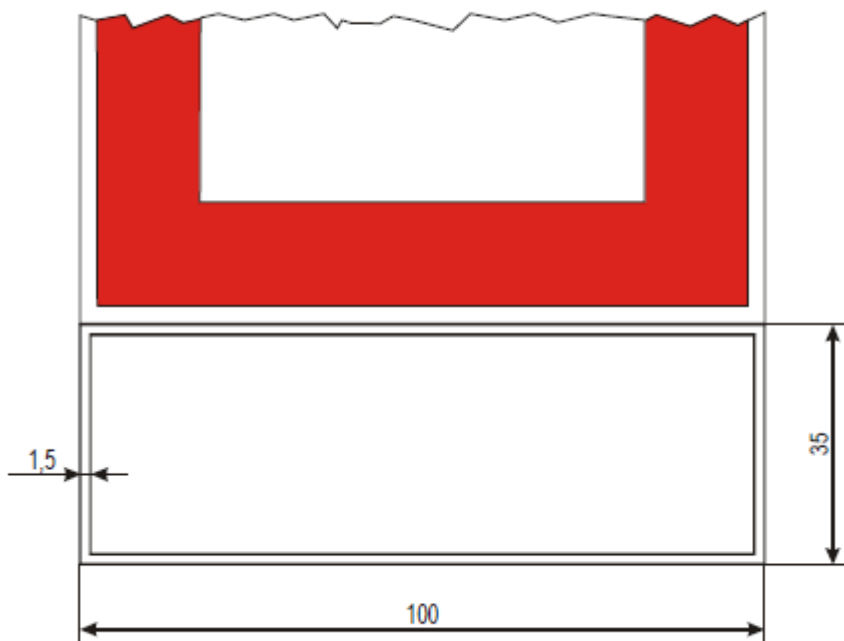

CEVNI Annex 8

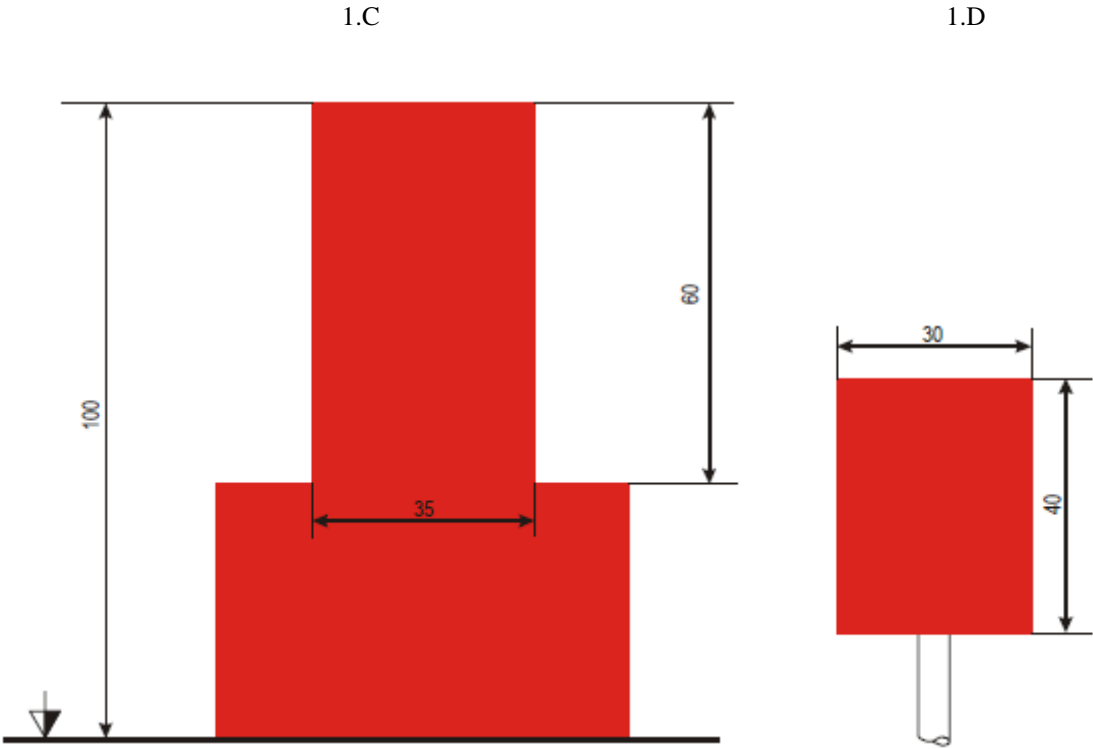

2.C

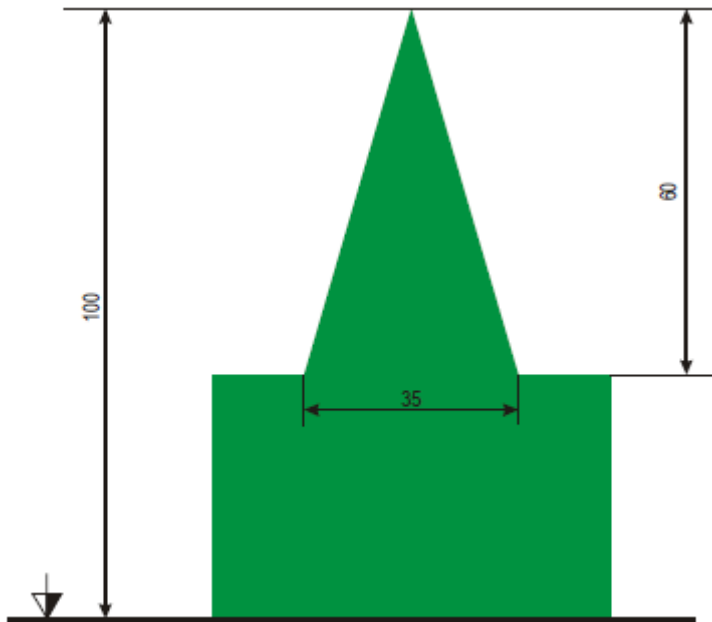

2.D

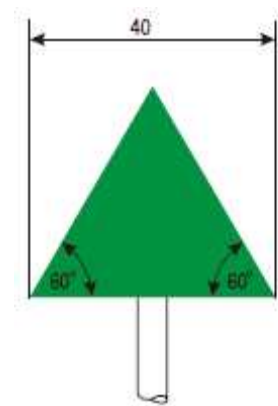

3.C

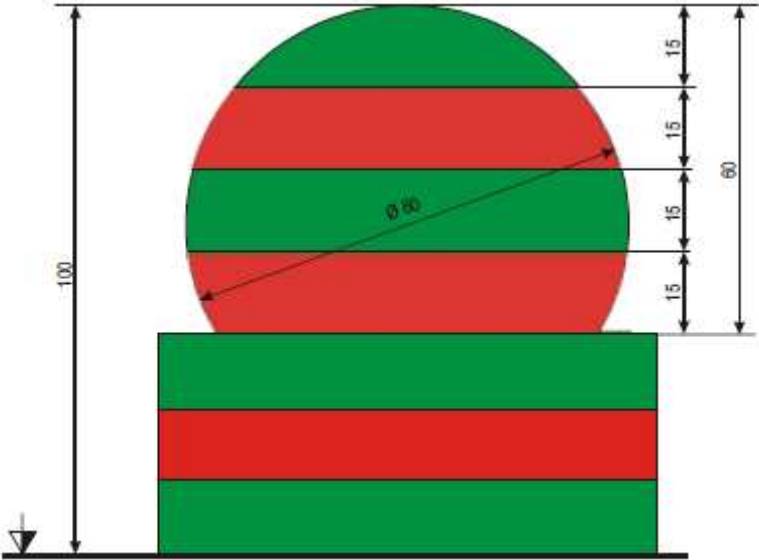

3.D

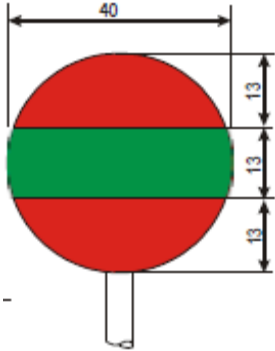

4.B

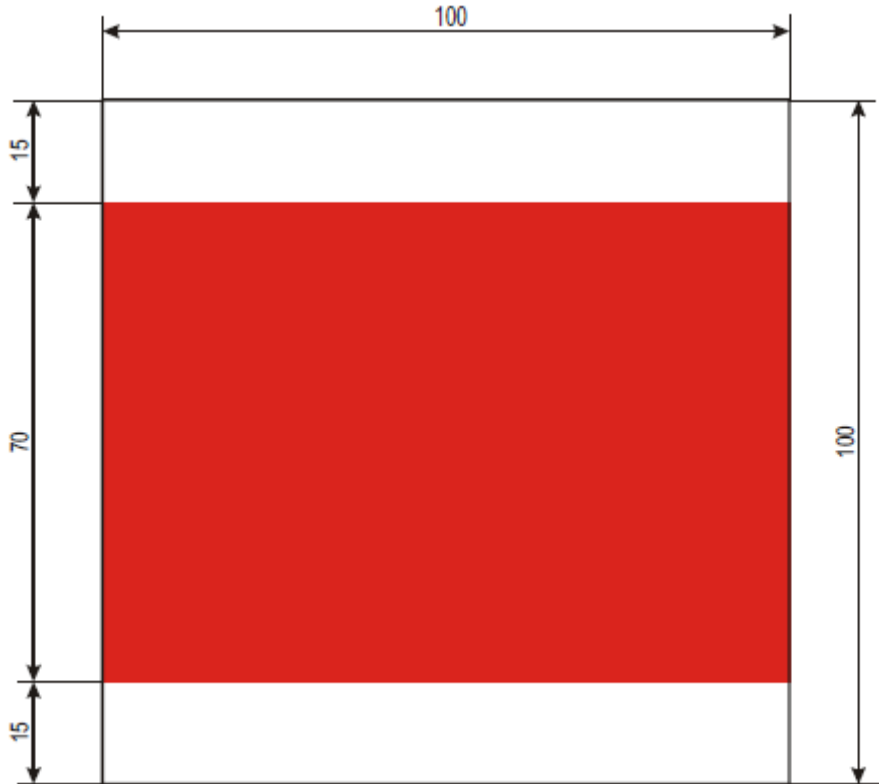

5.B

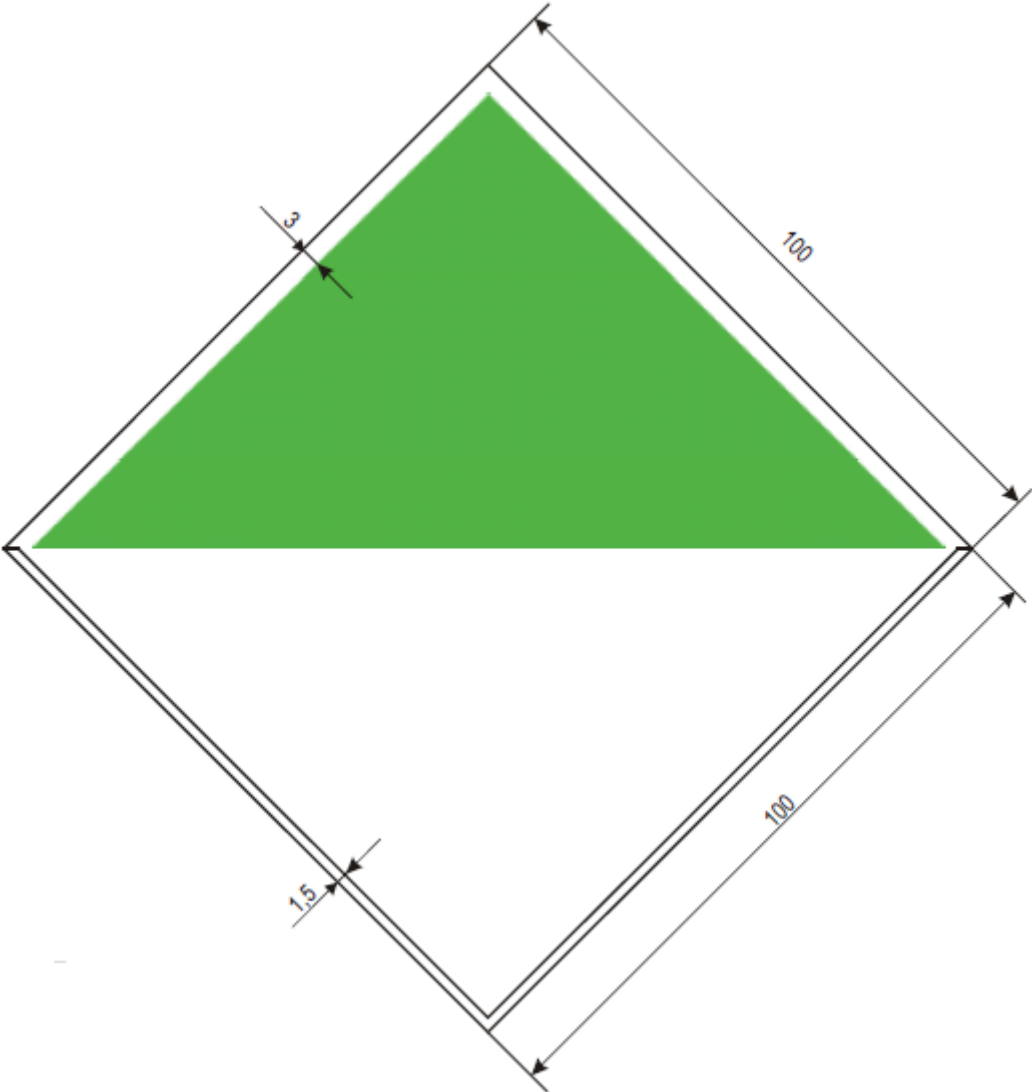

4.D

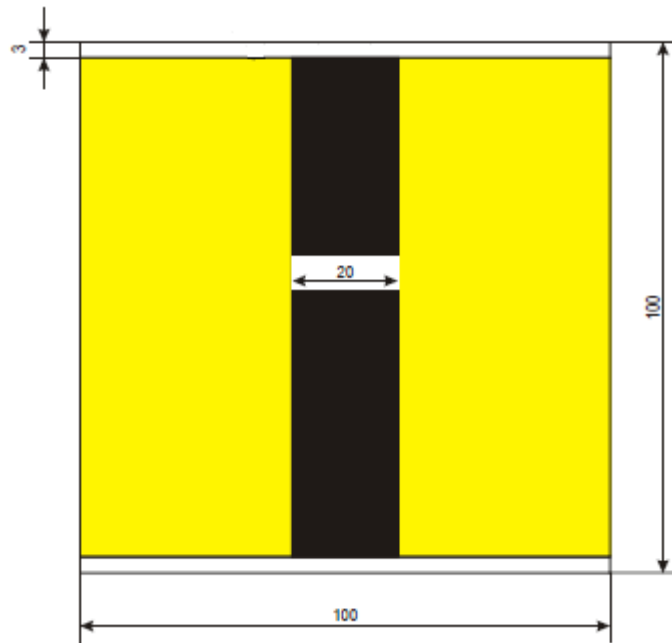

5.D

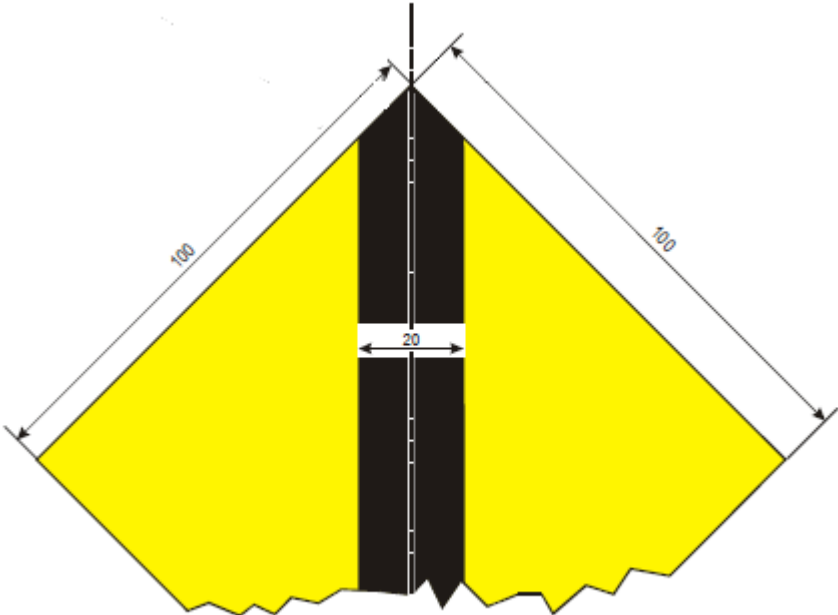

Annex 8 – 3.2

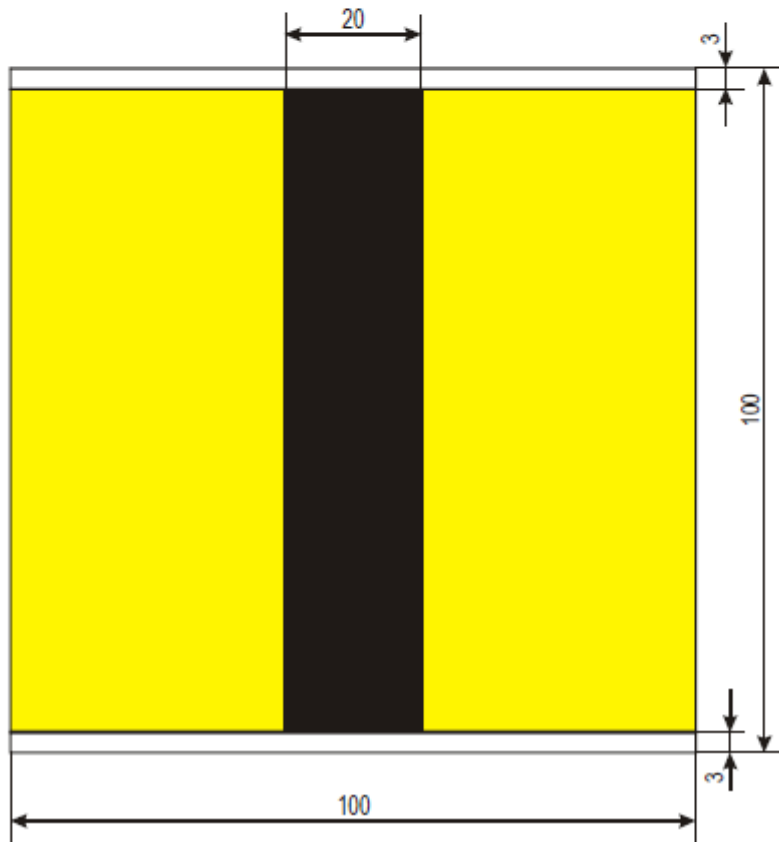
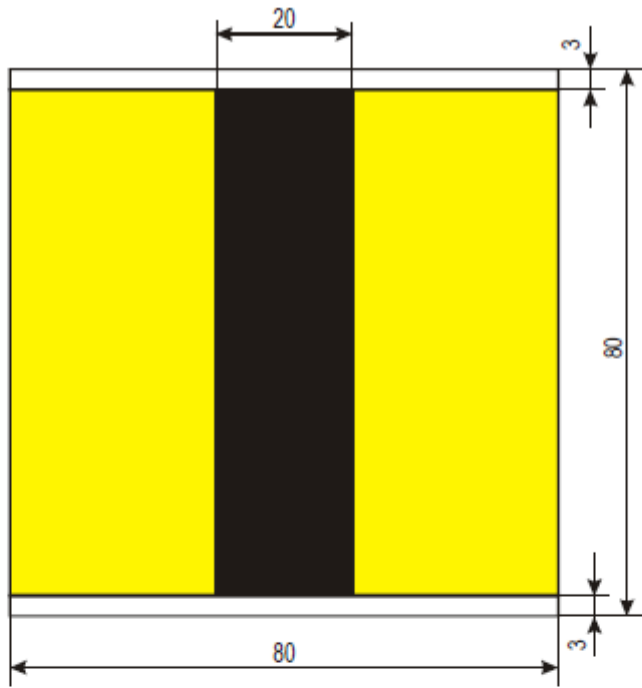

Annex 8 – 3.2

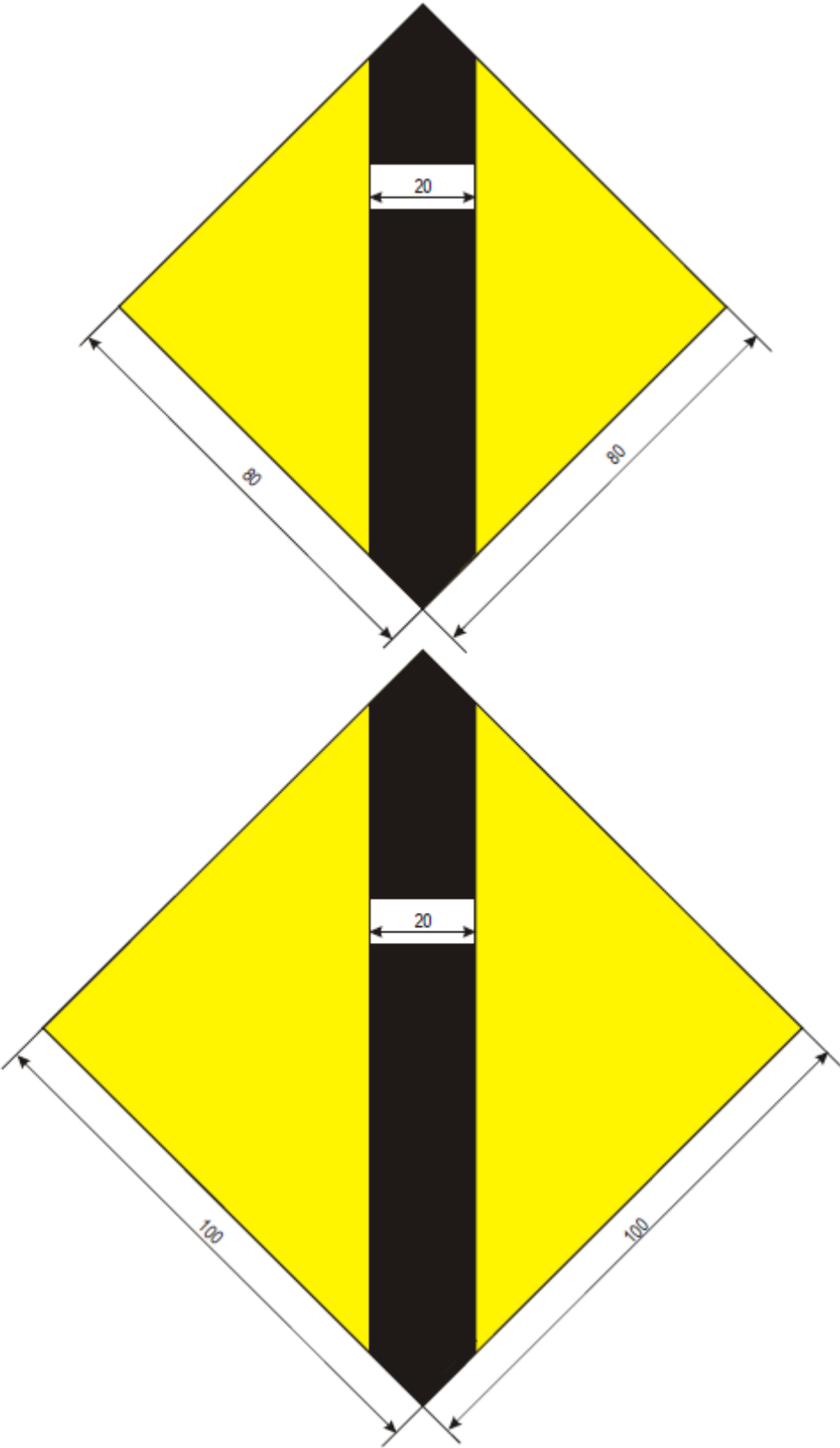

4.F

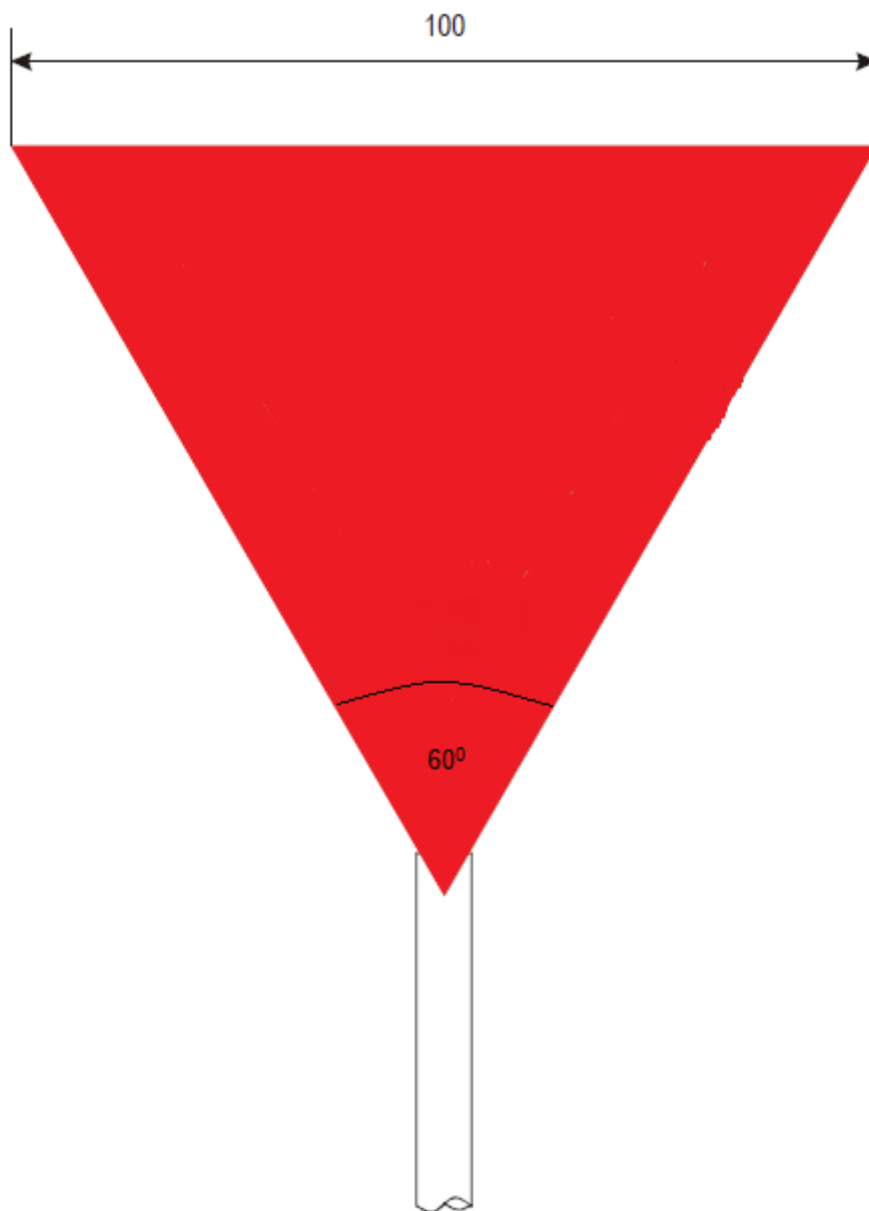

5.F

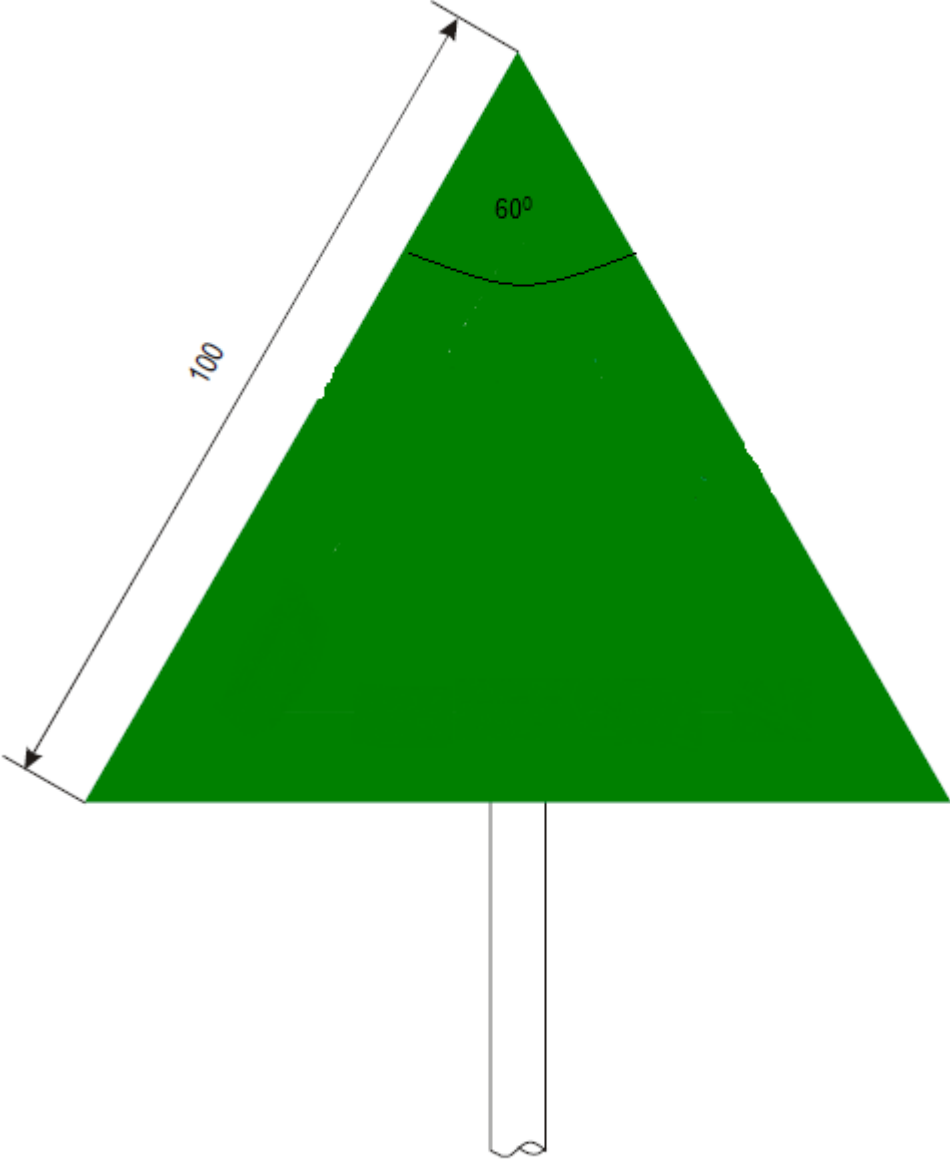

6.B

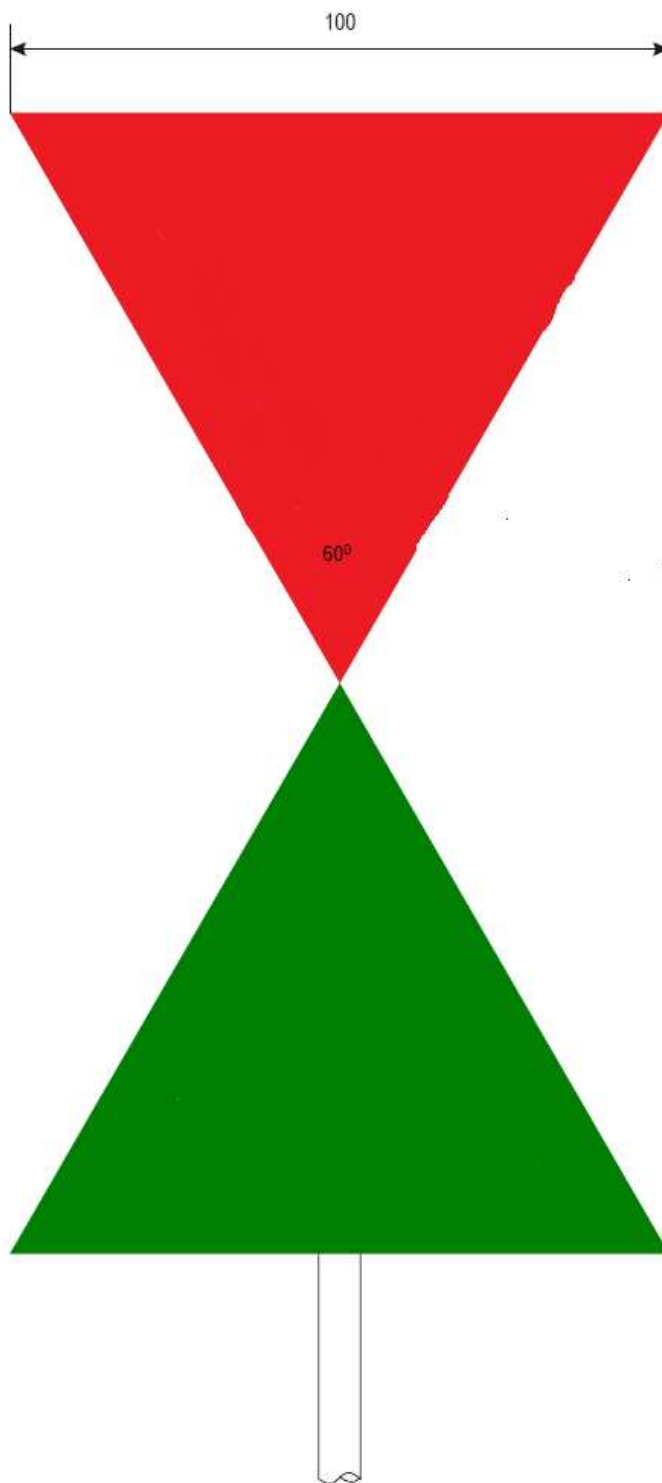

Radar reflector on bridges (Art. 6.4)

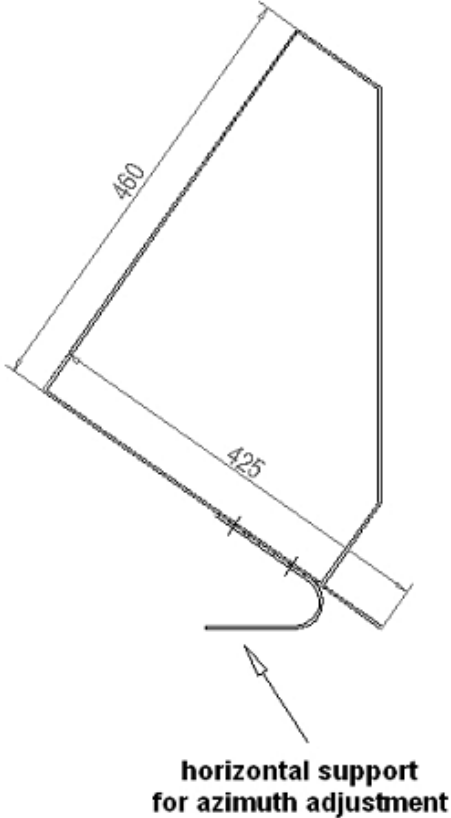
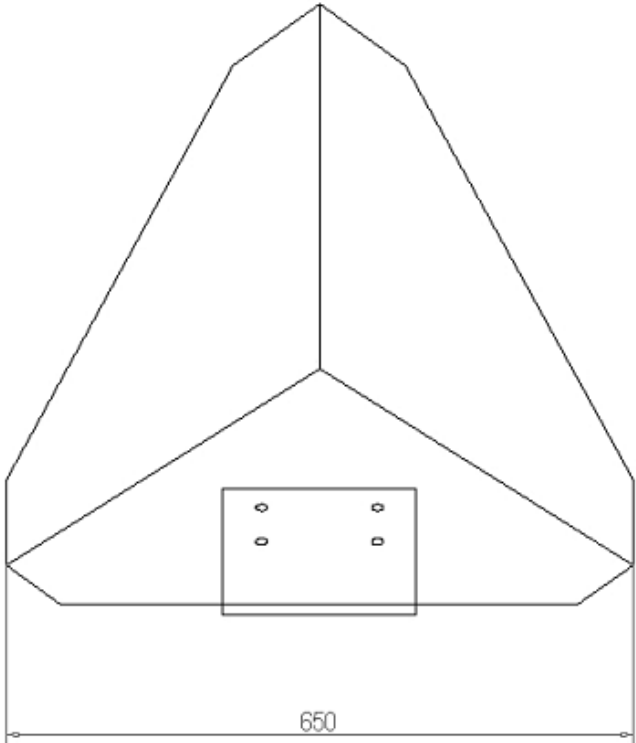

Radar reflector on buoys and markers (Art. 6.9 and 6.10)

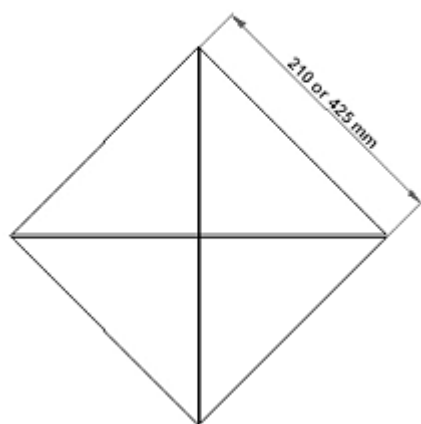
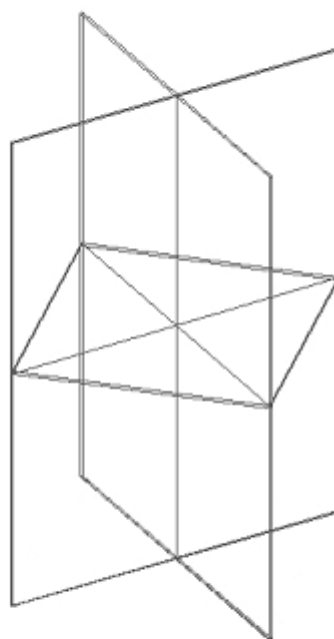
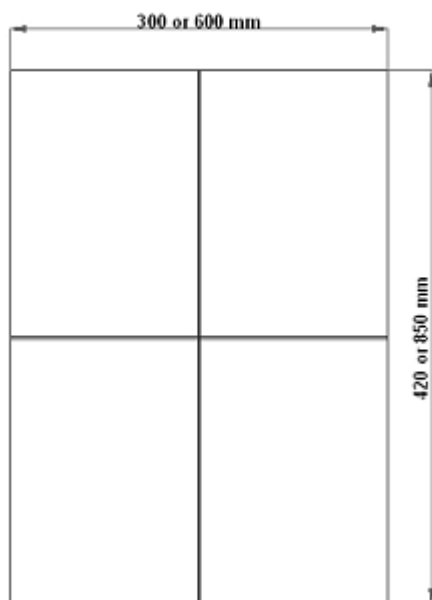

Appendix 2

Examples of the new Image Display Techniques

Light guide technology

Light guide technology, is mostly familiar from the matrix signalling devices positioned above roads. The images are displayed on lens arrays, linked by means of fibre optics (glass or plastic cable) to an optical device with, usually, a main and a back-up light. Every image is controlled from one or more optical devices. By switching the different optical devices on and off, different images, and therefore variable information, can be displayed.

Advantages

- (a) no mechanical/moving parts;
- (b) low maintenance;
- (c) high luminous intensity (adjustable);
- (d) high-fidelity imaging;
- (e) all-weather;
- (f) socket can be located accessibly.

Disadvantages

- (a) relatively costly;
- (b) limited number of images.

Light emitting diode (LED)

A LED is a small low voltage light source. Its visibility is limited by its angular aperture and the luminance of the LEDs. Images are made up of a large number of LEDs, each controlled separately. In other respects its properties are very similar to those of light guide technology.

Advantages

- (a) no mechanical/moving parts;
- (b) low maintenance;
- (c) simple control;
- (d) high-fidelity imaging.

Disadvantages

- (a) limited range of display colours;
- (b) light output affected by ambient temperature.

Electromagnetic segmented display

Any desired image can be displayed by reversing electromagnetic segments, one side of which is light and the other dark in colour. The angular aperture on these displays is wide, both horizontally and vertically.

Advantages

- (a) presentational flexibility;
- (b) displays in all colours;
- (c) easy to read;
- (d) low energy usage;
- (e) continues to display last image if power fails.

Disadvantages

- (a) displays must normally be kept in a conditioned cabinet because of moving parts;
- (b) lighting required when dark.

Rotary drum display

Rotary drum displays are suitable for displaying regularly changing configurations.

Advantages

- (a) Inland Waterways Police Regulations (IWPR) configuration can be accurately reproduced;
- (b) displays in all colours;
- (c) good visibility.

Disadvantages

- (a) mechanical parts, so maintenance facilities are necessary;
- (b) number of images limited;
- (c) lighting required when dark.

Moving screens

Moving screens can consist of a display with a large number of light dots (LED or bipolar segments), switched so as to form the arbitrary texts or diagrams. The text can also move, allowing a message of virtually unlimited length to be displayed.

Advantages

- (a) flexible, unlimited displays;
- (b) no moving parts;
- (c) all-weather.

Disadvantages

- (a) monochrome;
- (b) relatively expensive.

Application: information on waiting times, operating times, etc.
