

Status of NHTSA's Evaluation of WorldSID ATDs

October 2011

WorldSID 50th Male

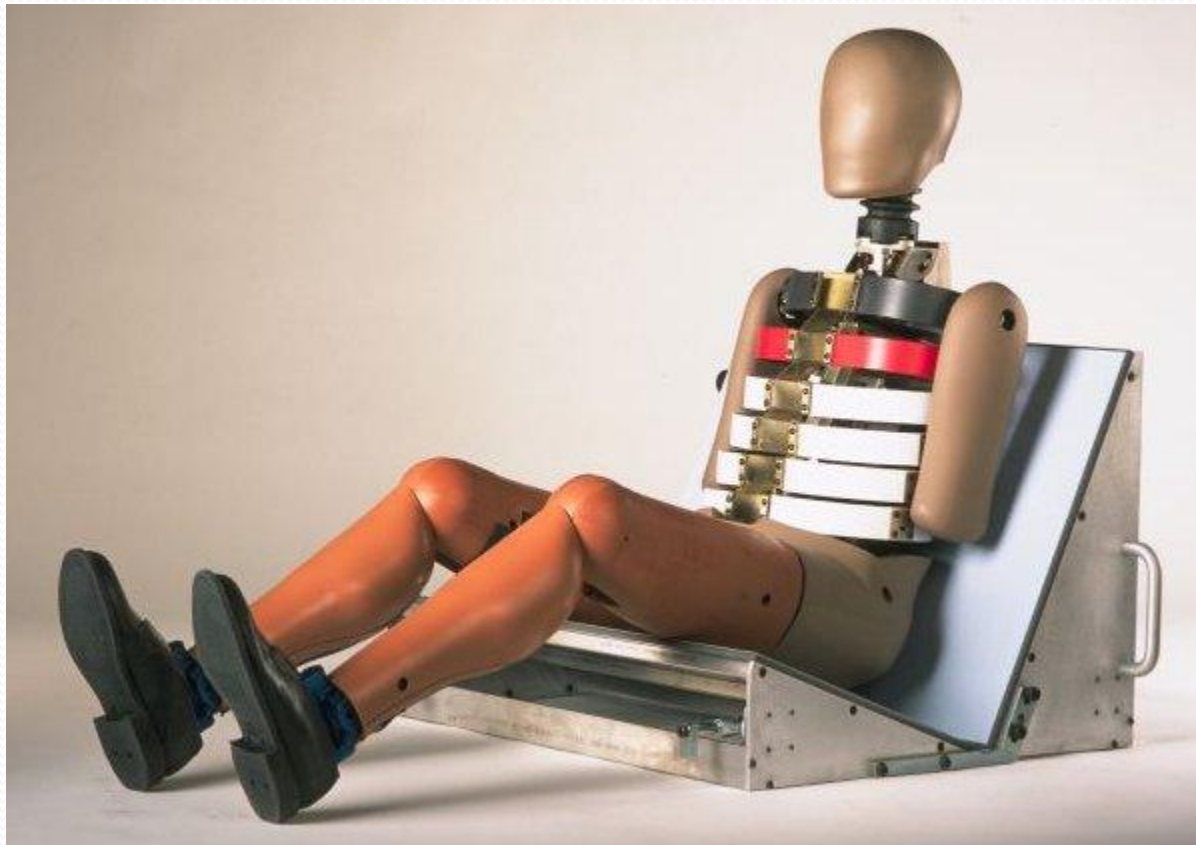

50th Male Status

- Dummy Testing Complete
 - Biofidelity
 - Certification
 - R&R
 - Durability

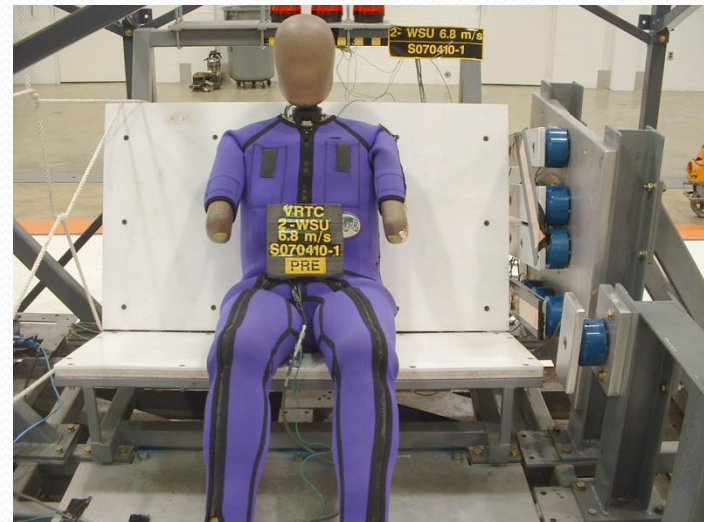

50th Male Status

- Planned Activities
 - Complete documentation necessary
 - Final Reports
 - User's Manual (PADI)
 - Drawing Package
 - Generic DAS Specification

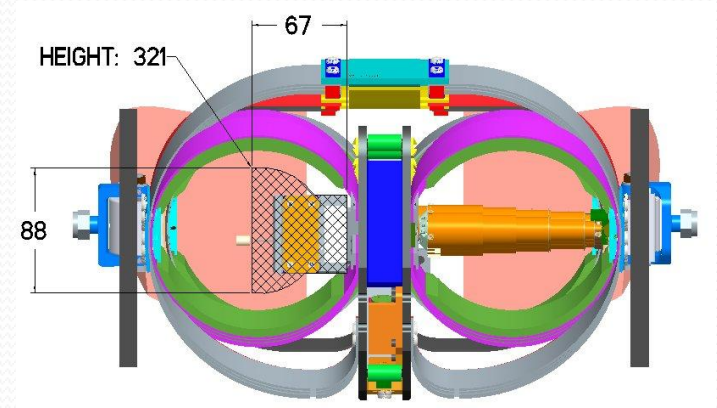
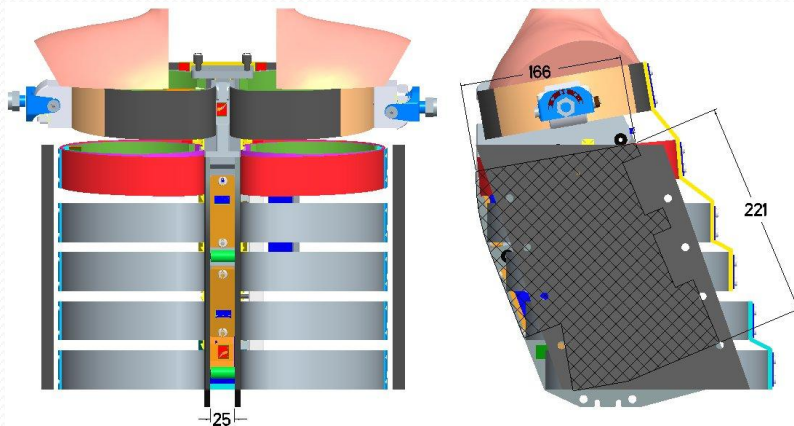

50th Male Status

- Potential Issues
 - Pelvis and head materials must be replaced

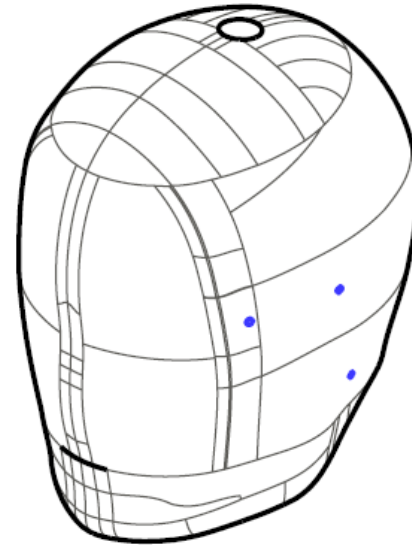
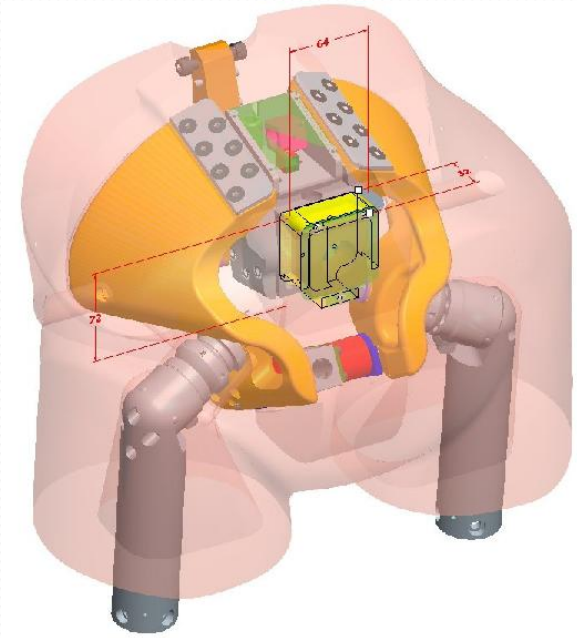

50th Male Status

- Potential Issues (cont'd)
 - Interference between lower abdominal rib and pelvis flesh

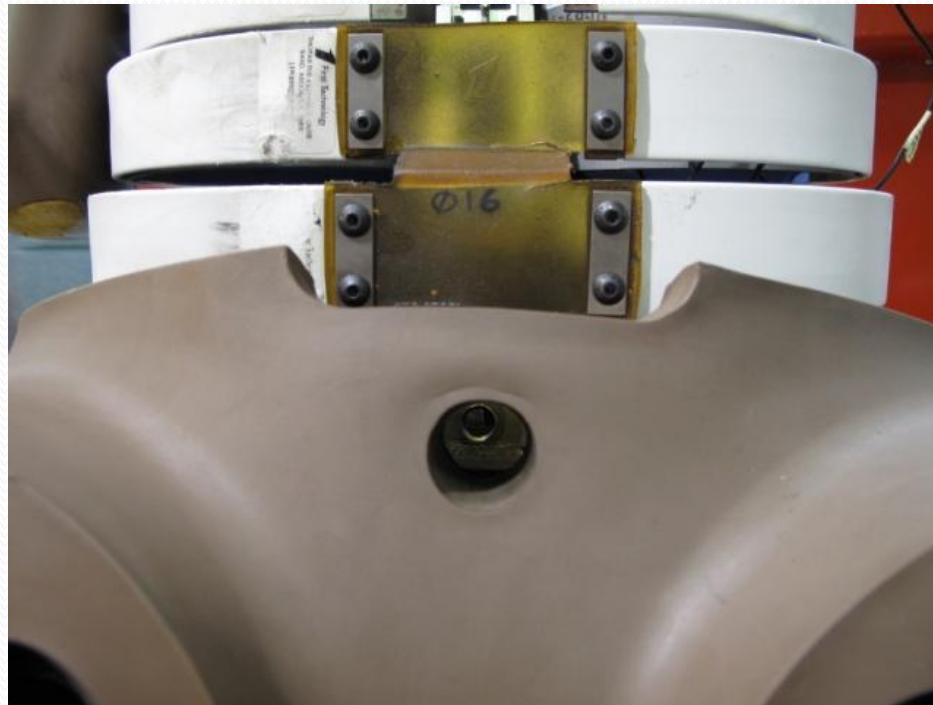

WorldSID 5th Female



5th Female Status

- Preliminary Inspections
 - Mass
 - External Dimensions
- Certification Tests
 - Conduct repeats tests
 - Right and left side
 - Assess R&R
 - 80% complete
- Biofidelity Assessment



5th Female Status

- Design Issues
 - Interference between lower abdominal rib and pelvis flesh (same as 50th male)

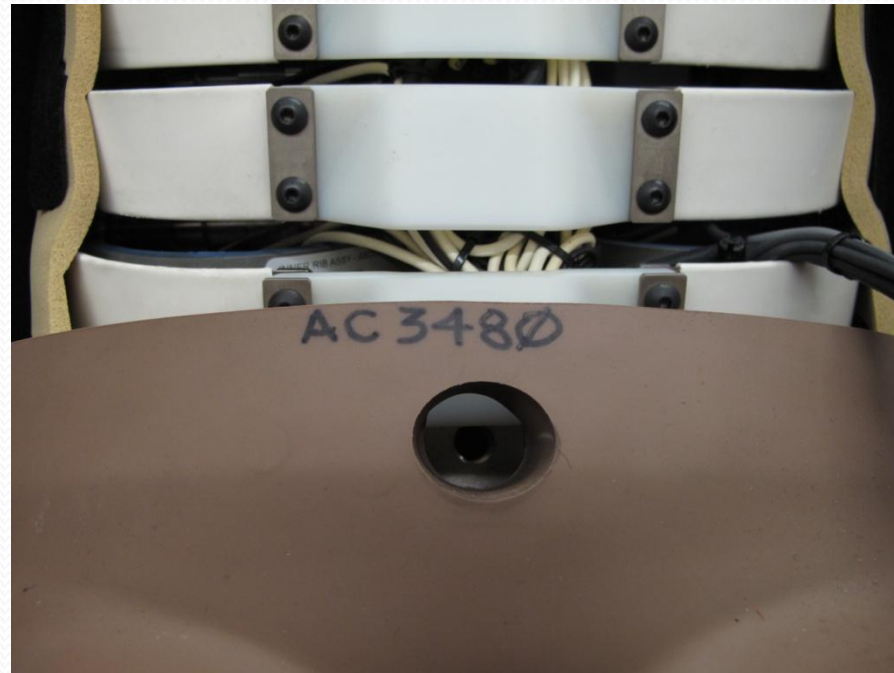

5th Female Status

- Design Issues (cont'd)
 - Pelvis contacts lower spine bracket

