

**Economic and Social Council**Distr.: General  
20 June 2016

Original: English

---

**Economic Commission for Europe****Inland Transport Committee****World Forum for Harmonization of Vehicle Regulations****Working Party on Noise****Sixty-fourth session**

Geneva, 5–7 September 2016

Item 8 of the provisional agenda

**Collective amendments****Proposal for Supplement 3 to Regulation No. 9****Submitted by the expert from the European Commission\***

The text reproduced below was prepared by the expert from the European Commission in accordance with a decision at the sixty-third session of the Working Party on Noise (GRB) (ECE/TRANS/WP.29/GRB/61, para. 14) to consider updating the provisions of Regulation No. 9 to a level at least equivalent to the corresponding provisions in the European Union legislation. The text below is based on Informal document GRB-63-08 and takes into account comments provided at the sixty-third session of GRB as well as comments communicated to the European Commission after the session. It proposes improved terminology and definitions, including new ones, improved sound emission testing conditions and procedures. It also introduces sound emission measurement through new testing of in use vehicles in motion. The proposed amendments to the current Regulation are incorporated into the consolidated text and marked in bold for new or strikethrough for deleted characters.

---

\* In accordance with the programme of work of the Inland Transport Committee for 2014–2018 (ECE/TRANS/240, para. 105 and ECE/TRANS/2014/26, programme activity 02.4), the World Forum will develop, harmonize and update Regulations in order to enhance the performance of vehicles. The present document is submitted in conformity with that mandate.



## I. Proposal

Regulation No. 9, amend to read:

### **"Uniform provisions concerning the approval of category L<sub>2</sub>, L<sub>4</sub> and L<sub>5</sub> vehicles with regard to noise sound emission"**

#### Contents

Regulation	Page**
1. Scope .....	
2. Definitions.....	
3. Application for approval .....	
4. Markings .....	
5. Approval .....	
6. Specifications .....	
7. Modification and extension of approval of a vehicle type or a type of exhaust or silencing system(s) .....	
8. Conformity of production.....	
9. Penalties for non-conformity of production .....	
10. Production definitively discontinued.....	
11. Transitional provisions .....	
12. Names and addresses of Technical Services responsible for conducting approval tests, and of Type Approval Authorities.....	
<b>Annexes</b>	
1. Communication .....	
2. Arrangements of the approval mark .....	
3. Methods and instruments for measuring the <b>noise sound</b> made by motor vehicles .....	
4. Maximum sound level limits (new vehicles).....	
5. Specifications for the test site.....	

---

\*\* Page numbers will be added at a later stage.

## 1. Scope

This Regulation applies to vehicles of category L<sub>2</sub>, L<sub>4</sub> and L<sub>5</sub><sup>1</sup> with regard to ~~noise~~ **sound emission**.

## 2. Definitions

For the purposes of this Regulation,

- 2.1. "*Approval of a vehicle*" means the approval of a vehicle type with regard to the ~~noise~~ **sound** level and the original exhaust system as a technical unit **of a vehicle type, falling under the scope of this Regulation**.
- 2.2. "*Vehicle type*" means a category of motor vehicles which do not differ in such essential respects as:
- 2.2.1. The lines and constituent materials of the body (more particularly the engine compartment and its soundproofing);
- 2.2.2. The length and width of the vehicle;
- 2.2.3. The type of engine (positive ignition or compression ignition; reciprocating or rotary piston; number and capacity of cylinders; number and type of carburettors or injection systems, arrangement of valves; rated maximum net power and rated engine speed).
- For rotary piston engines, the cubic capacity should be taken to be double of the volume of the chamber.
- 2.2.4. **The electric motor in case of a hybrid electric vehicle.**
- ~~2.2.4.2.2.5.~~ ~~Number and ratios of gears.~~ **Drive train, in particular the number and ratios of the gears of the transmission and the final ratio.**
- ~~2.2.5.2.2.6.~~ The number, type and arrangement of exhaust systems.
- 2.3. "*Rated maximum net power*" **of the combustion engine** means the rated engine power as defined in ISO 4106:2004**2012**.
- The symbol  $P_n$  denotes the numerical value of the rated maximum net power expressed in kW.**
- 2.4. "*Rated engine speed*" **of the combustion engine** means the engine speed at which the engine develops its rated maximum net power as stated by the manufacturer.<sup>2</sup>
- The symbol  $n_{rated}$  denotes the rated engine speed expressed in  $\text{min}^{-1}$ .**
- ~~2.3.~~ 2.5. "*Exhaust or silencing system(s)*" means a complete set of components necessary for limiting the ~~noise made~~ **sound emitted** by a motor vehicle and its exhaust.

<sup>1</sup> As defined in the Consolidated resolution on the Construction of vehicles (R.E.3), document ECE/TRANS/WP.29/78/Rev.4, para.2.

<sup>2</sup> If the rated maximum net power is reached at several engine speeds, the rated engine speed is used in this Regulation as the highest engine speed at which the rated maximum net power is reached.

~~2.35.1.~~ "Original exhaust or silencing system" means a system of the type with which the vehicle is equipped on acceptance or extension of acceptance. It may be part of the original equipment or a replacement.

~~2.4.2.6.~~ "Exhaust or silencing systems of different types" means exhaust or silencing systems which differ in such essential respects as:

~~2.4.1. 2.6.1.~~ That their components bear different trade names or marks;

~~2.4.2. 2.6.2.~~ That the characteristics of the materials constituting a component are different or that the components differ in shape or size;

~~2.4.3. 2.6.3.~~ That the operating principles of at least one component are different;

~~2.4.4. 2.6.4.~~ That their components are assembled differently.

~~2.5. 2.7.~~ "Exhaust or silencing system component" means one of the individual constituent parts whose assembly constitutes the exhaust or silencing system.<sup>3</sup>

**If the engine is fitted with an intake device (air filter and/or an intake sound absorber essential in order to ensure conformity with sound level limits), this device shall be considered to be a component of the same importance as the exhaust system proper, and be included in the list referred to in paragraph 3.2.2. below and carry the markings prescribed in paragraph 4.1. below.**

~~2.6.2.8.~~ "~~Kerb~~ Reference mass" (as defined in section 4.1.2 of ISO 6726: 1988) means the mass of the vehicle ready for normal operation and fitted with the following equipment:

- (a) Full electrical equipment including the lighting and signalling devices supplied by the manufacturer;
- (b) All instruments and fittings required by any legislation in respect of which a measurement of the vehicle dry mass is being made;
- (c) Full complement of liquids to ensure the correct functioning of every part of the vehicle and the fuel tank filled at least to 90 per cent of the capacity specified by the manufacturer;
- (d) Auxiliary equipment usually supplied by the manufacturer in addition to that necessary for normal operation (tool-kit, carrier(s), windscreen(s), protective equipment, etc.),
- (e) **the mass of the propulsion battery, if applicable.**

**The symbol  $m_{ref}$  denotes the reference mass expressed in kg.**

Notes:

- 1. In the case of a vehicle which operates on a fuel/oil mixture:
  - 1.1. Where the fuel and oil are premixed, the word "fuel" is interpreted as including such a pre-mixture of fuel and oil;

<sup>3</sup> These components are, in particular, the exhaust manifold, the exhaust piping, the expansion chamber, the silencer proper, etc. If the engine intake is equipped with an air filter and the filter's presence is essential to ensure observance of the prescribed sound-level limits, the filter must be regarded as a component of the "exhaust or silencing system(s)" and bear the marking prescribed in paragraphs 3.2.2. and 4.1.

- 1.2. Where the fuel and oil are separately measured, the word "fuel" is interpreted as including only the petrol. The "oil", in this case, is already included in subparagraph (c) of this paragraph.

## 2.9 "Test mass"

**The test mass is the reference mass plus the combined mass of the driver and test equipment.**

**The combined mass of the driver and test equipment used on the vehicle shall not be more than 90 kg nor less than 70 kg. Weights shall be placed on the vehicle, if the 70 kg minimum is not reached.**

**The symbol  $m_t$  denotes the test mass expressed in kg.**

- 2.710. "*Maximum vehicle speed*" means the maximum vehicle **design** speed as defined in ISO 7117:1995 measured according to ISO 7116:2011 for L<sub>2</sub> category vehicles and according to ISO 7117:2010 for L<sub>4</sub> and L<sub>5</sub> category vehicles.

**The symbol  $v_{max}$  denotes the maximum vehicle speed expressed in km/h.**

## 3. Application for approval

- 3.1. The application for approval of a vehicle type with regard to ~~noise~~ **sound** shall be submitted by its manufacturer or by his duly accredited representative.
- 3.2. It shall be accompanied by the under mentioned documents in triplicate and the following particulars:
- 3.2.1. A description of the vehicle type with regard to the items mentioned in paragraph 2.2. above. The numbers and/or symbols identifying the engine type and the vehicle type shall be specified;
- 3.2.2. A list of the components, duly identified, constituting the exhaust or silencing system;
- 3.2.3. A drawing of the assembled exhaust or silencing system and an indication of its position on the vehicle;
- 3.2.4. Detailed drawings of each component to enable it to be easily located and identified, and a specification of the materials used.
- 3.3. At the request of the Technical Service conducting approval tests, the vehicle manufacturer shall, in addition, submit a sample of the exhaust or silencing system.
- 3.4. A vehicle representative of the vehicle type to be approved shall be submitted to the Technical Service conducting approval tests.

## 4. Markings

- 4.1. The components of the exhaust or silencing system shall bear at least the following identifications marks:
- 4.1.1. The trade name or mark of the manufacturer of the exhaust or silencing system and of its components;
- 4.1.2. The trade description given by the manufacturer;

- 4.1.3. The identifying part numbers;
- 4.1.4. For all original silencers, the "E" mark followed by the identification of the country which granted the component type approval.<sup>4</sup>
- 4.1.5. Any packing of original replacement exhaust or silencing systems shall be marked legibly with the words "original part" and the make and type references integrated together with the "E" mark and also the reference of the country of origin.
- 4.1.6. Such markings shall be indelible, clearly legible and also visible, in the position at which it is to be fitted to the vehicle.

## **5. Approval**

- 5.1. If the vehicle type submitted for approval pursuant to this Regulation meets the requirements of paragraphs 6. and 7. below, approval of that vehicle type shall be granted.
- 5.2. An approval number shall be assigned to each type approved. Its first two digits (at present 07 corresponding to the 07 series of amendments which entered into force on 3 November 2013) shall indicate the series of amendments incorporating the most recent major technical amendments made to the Regulation at the time of issue of the approval. The same Contracting Party shall not assign the same number to the same vehicle type equipped with another type of exhaust or silencing system or to another vehicle type.
- 5.3. Notice of approval or of extension or refusal of approval of a vehicle type pursuant to this Regulation shall be communicated to the Parties to the Agreement which apply this Regulation by means of a form conforming to the model shown in Annex 1 to this Regulation and of drawings of the exhaust or silencing system (supplied by the applicant for approval) in a format not exceeding A4 (210 x 297 mm), or folded to that format, and on an appropriate scale.
- 5.4. There shall be affixed, conspicuously and in a readily accessible place specified on the approval form, to every vehicle conforming to a vehicle type approved under this Regulation an international approval mark consisting of:
  - 5.4.1. A circle surrounding the letter "E" followed by the distinguishing number of the country which has granted approval;<sup>4</sup> and
  - 5.4.2. The number of this Regulation, followed by the letter "R", a dash and the approval number, to the right of the circle prescribed in paragraph 5.4.1. above.
- 5.5. If the vehicle conforms to a vehicle type approved, under one or more other Regulations annexed to the 1958 Agreement, in the country which has granted approval under this Regulation, the symbol prescribed in paragraph 5.4.1. above need not be repeated; in such a case the additional numbers and symbols of all the Regulations under which approval has been granted in the country which has granted approval under this Regulation shall

---

<sup>4</sup> The distinguish numbers of the Contracting Parties to the 1958 Agreement are reproduced in Annex 3 to the Consolidated Resolution on the Construction of Vehicles (R.E.3), document ECE/TRANS/WP.29/78/Rev.4.

be placed in vertical columns to the right of the symbol prescribed in paragraph 5.4.1. above.

- 5.6. The approval mark shall be clearly legible and be indelible.
- 5.7. The approval mark shall be placed close to or on the vehicle data plate.
- 5.8. Annex 2 to this Regulation gives examples of arrangements of approval marks.

## 6. Specifications

- 6.1. General specifications
  - 6.1.1. The vehicle, its engine and its exhaust or silencing system shall be so designed, constructed and assembled as to enable the vehicle, in normal use, despite the vibration to which it may be subjected, to comply with the provisions of this Regulation.
  - 6.1.2. The exhaust or silencing system shall be so designed, constructed and assembled as to be able to resist the corrosive action to which it is exposed.
  - 6.1.3. The following information shall be provided on the motor vehicle in an easily accessible but not necessarily immediately visible location:
    - (a) The manufacturer's name;
    - (b) The target engine speed and the final result of the stationary test as defined in paragraph 3.2.4. of Annex 3.

### 6.2. Specifications regarding sound levels

- 6.2.1. Methods of measurement
  - 6.2.1.1. The ~~noise made~~ **sound emitted** by the vehicle type submitted for approval shall be measured by the ~~two~~ method(s) described in Annex 3 to this Regulation for the vehicle in motion and for the vehicle when stationary;<sup>5</sup> in the case of a vehicle ~~where~~ **with an electric motor or with** an internal combustion engine **that** does not operate when the vehicle is stationary, the emitted ~~noise sound~~ shall only be measured when the vehicle is in motion.

**If the vehicle has user selectable software programs or modes which affect the sound emission of the vehicle, all these modes shall be in compliance with the requirements in this paragraph. Testing shall be based on the worst case scenario.**

**For hybrid electric vehicles, the tests shall be performed twice under the following conditions:**

- (a) **condition A: The batteries shall be at their maximum state of charge; if more than one 'hybrid mode' is available, the most electric hybrid mode shall be selected for the test;**
- (b) **condition B: The batteries shall be at their minimum state of charge; if more than one 'hybrid mode' is available, the most fuel-consuming hybrid mode shall be selected for the test.**

**The final result is the highest of the test results for conditions A and B.**

---

<sup>5</sup> A test is made on a stationary vehicle in order to provide a reference value for administrations which use this method to check vehicles in use.

- 6.2.1.2. The ~~two~~ value(s) measured in accordance with the provisions of paragraph 6.2.1.1. above shall be entered in the test report and on a form conforming to the model in Annex 1 to this Regulation.
- 6.2.1.3. ~~The sound level measured by the method described in paragraph 3.1. of Annex 3 to this Regulation, when the vehicle is in motion, shall not exceed (for new vehicles and new exhaust or silencing system(s)) 80 dB(A) for categories L<sub>4</sub> and L<sub>5</sub> and 76 dB(A) for category L<sub>2</sub>. The sound level determined by the method described in paragraph 3.1. of Annex 3 to this Regulation when the vehicle is in motion shall not exceed the limits prescribed (for new vehicles and new exhaust or silencing systems) in Annex 4 to this Regulation for the category to which the vehicle belongs.~~
- 6.3. Additional ~~requirements~~ **prescriptions related to tamperability and manually adjustable multi-mode exhaust or silencing systems**
- 6.3.1. **Tampering protection provisions**
- All exhaust or silencing systems shall be constructed in a way that does not ~~easily~~ permit removal of baffles, exit-cones and other parts whose primary function is as part of the silencing/expansion chambers. Where incorporation of such a part is unavoidable, its method of attachment shall be such that removal is not facilitated ~~easily~~ (e.g. with conventional threaded fixings) and ~~should~~ **shall** also be attached such that removal causes permanent/irrecoverable damage to the assembly.
- 6.3.2. **Multi-mode exhaust or silencing systems**
- Exhaust or silencing systems with multiple, manually **or electronically** adjustable, **rider selectable** operating modes shall meet all requirements in all operating modes. The reported ~~noise sound~~ levels shall be those resulting from the mode with the highest ~~noise sound~~ levels.
- 6.3.3. **Prohibition of defeat devices**
- The vehicle manufacturer shall not intentionally alter, adjust or introduce any device or procedure solely for the purpose of fulfilling the ~~noise sound~~ emission requirements of this Regulation, which will not be operational during typical on-road operation.

## 7. **Modification and extension of approval of a vehicle type or a type of exhaust or silencing system(s)**

- 7.1. Every modification of the vehicle type or of the exhaust or silencing system shall be notified to the Type Approval Authority which approved the vehicle type. The said Authority may then either:
- 7.1.1. Consider that the modifications made are unlikely to have an appreciable adverse effect; or
- 7.1.2. Require a further test report from the Technical ~~Testing-Service~~ **responsible for conducting the tests.**
- 7.2. Confirmation or refusal of approval, specifying the alterations, shall be communicated to the Parties to the Agreement applying this Regulation in accordance with the procedure specified in paragraph 5.3. above.
- 7.3. The Type Approval Authority issuing the extension of approval shall assign a series number for such an extension and inform thereof the other Contracting Parties to the 1958 Agreement applying this Regulation by means of a



communication form conforming to the model given in Annex 1 to this Regulation.

## **8. Conformity of production**

The conformity of production procedures shall comply with those set out in the Agreement, Appendix 2 (E/ECE/324-E/ECE/TRANS/505/Rev.2), with the following requirements:

- 8.1. Every vehicle bearing an approval mark as prescribed under this Regulation shall conform to the vehicle type approved, be fitted with the exhaust or silencing system(s) with which it was approved and satisfy the requirements of paragraph 6. above.
- 8.2. In order to verify conformity as prescribed in paragraph 8.1. above, a vehicle, bearing the approval mark required by this Regulation, shall be taken from the series. Production shall be deemed to conform to the requirements of this Regulation if the levels measured using the method described in Annex 3 do not exceed by more than 3 dB(A) the value measured on acceptance, nor by more than 1 dB(A) the limits prescribed in paragraph 6.2.1.3. above.

## **9. Penalties for non-conformity of production**

- 9.1. The approval granted in respect of a vehicle type pursuant to this Regulation may be withdrawn if the requirements laid down in paragraph 8. above are not complied with, or if the vehicle fails to pass the tests provided for in paragraph 8.2. above.
- 9.2. If a Party to the Agreement which applies this Regulation withdraws an approval it has previously granted, it shall forthwith so notify the other Contracting Parties applying this Regulation by means of a communication form conforming to the model given in Annex 1 to this Regulation.

## **10. Production definitively discontinued**

If the holder of the approval completely ceases to manufacture a vehicle or a exhaust or silencing system approved in accordance with this Regulation, he shall so inform the Type Approval Authority which had granted the approval. Upon receiving the relevant communication, that Authority shall inform thereof the other Parties to the Agreement applying this Regulation by means of a communication form conforming to the model given in Annex 1 to this Regulation.

## **11. Transitional provisions**

- 11.1. As from the official date of entry into force of the 07 series of amendments, no Contracting Party applying this Regulation shall refuse to grant or refuse to accept type approvals under this Regulation as amended by the 07 series of amendments.
- 11.2. As from 24 months after the date of entry into force of the 07 series of amendments, Contracting Parties applying this Regulation shall grant type approvals only if the vehicle type to be approved meets the requirements of this Regulation as amended by the 07 series of amendments.

- 11.3. Contracting Parties applying this Regulation shall not refuse to grant extensions of type approvals for existing types which have been granted according to the preceding series of amendments to this Regulation.
- 11.4. Until 24 months after the date of entry into force of the 07 series of amendments to this Regulation, no Contracting Party applying this Regulation shall refuse national or regional type approval of a vehicle type-approved to the preceding series of amendments to this Regulation.
- 11.5. As from 24 months after the date of entry into force of the 07 series of amendments to this Regulation, Contracting Parties applying this Regulation shall not be obliged to accept, for the purpose of national or regional type approval, a vehicle type approved to the preceding series of amendments to this Regulation.
- 11.6. Notwithstanding the transitional provisions above, Contracting Parties whose application of this Regulation comes into force after the date of entry into force of the most recent series of amendments are not obliged to accept type approvals which were granted in accordance with any of the preceding series of amendments to this Regulation are only obliged to accept type approval granted in accordance with the 07 series amendments.
- 11.7. As from the official date of entry into force of Supplement 1 to the 07 series of amendments, no Contracting Party applying this Regulation shall refuse to grant or refuse to accept type approval according to Supplement 1 to 07 series of amendments to the Regulation.**
- 11.8. As from 60 months after the date of entry into force of Supplement 1 to the 07 series of amendments to this Regulation, Contracting Parties applying this Regulation shall grant type approvals only if the vehicle type to be approved meets the requirements of this Regulation as amended by Supplement 1 to the 07 series of amendments to this Regulation.**

## **12. Names and addresses of Technical Services responsible for conducting approval tests, and of Type Approval Authorities**

The Parties to the Agreement which apply this Regulation shall communicate to the United Nations Secretariat the names and addresses of the Technical Services responsible for conducting approval tests and of the Type Approval Authorities which grant approval and to which forms certifying approval or extension or refusal or withdrawal of approval or production definitively discontinued, issued in other countries, are to be sent.

# Annex 1

## Communication

(maximum format: A4 (210 x 297 mm))

issued by: Name of administration:

.....  
 .....  
 .....

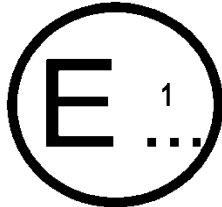

concerning:<sup>2</sup> Approval granted  
 Approval extended  
 Approval refused  
 Approval withdrawn  
 Production definitively discontinued

of a vehicle type with regard to its **noise sound** emission pursuant to Regulation No. 9

Approval No. .... Extension No. ....

- 1. Trade name or mark of the vehicle: .....
- 2. Vehicle type: .....
- 2.1. Variant(s) (as necessary): .....
- 2.2. Version(s) (as necessary): .....
- 3. Manufacturer's name and address: .....
- 4. If applicable, name and address of manufacturer's representative: .....
- 5. **Combustion engine**.....
- 5.1. **Engine manufacturer**.....
- 5.2. **Engine type**.....
- 5.3. Kind of engine: e.g., positive-ignition, compression ignition, etc.<sup>3</sup>.....
- ~~6- 5.4.~~ Cycles: two-stroke or four-stroke (if applicable)<sup>2</sup>.....
- ~~7- 5.5.~~ **Cylinder Engine** capacity (if applicable): ..... **cm<sup>3</sup>**
- ~~8- 5.6.~~ Rated maximum net power (method of measurement): ..... **kW**
- ~~9- 5.7.~~ Rated engine speed (~~min<sup>-1</sup>~~): ..... **min<sup>-1</sup>**
- 6. **Electric motor (if applicable)**

<sup>1</sup> Distinguishing number of the country which has granted/extended/refused/withdrawn approval (see approval provisions in the Regulation).

<sup>2</sup> Strike out what does not apply.

<sup>3</sup> If a non-conventional engine is used, this should be stated.

- 6.1. **Make**.....
- 6.2. **Type**.....
- 7. **Transmission**
- 7.1. **Make**.....
- 7.2. **Type (manual, automatic, CVT)** .....
- ~~10.~~ 7.3. Number of gears: .....
- ~~11.~~ 7.4. Gears used: .....
- ~~12.~~ 7.5. Final drive ratio(s): .....
- ~~13.~~ 8. Type and dimensions of tyres (by axle): .....
- ~~14.~~ 9. Maximum permissible weight including semi-trailer (where applicable): ... **kg**
- ~~15.~~ 10. Brief description of the original exhaust system:.....
- ~~15.1.~~ 11. Type(s) of original exhaust system(s):.....
- ~~15.2.~~ 12. Type(s) of intake system(s) (if necessary in order to observe the ~~noise~~ **sound** level limit): .....
- ~~16.~~ 13. Load conditions of vehicles during test: .....
- ~~17.~~ 14. For stationary vehicle test: location and orientation of the microphone (by reference to diagrams in Annex 3 to this Regulation - Appendix): .....
- ~~18.~~ 15. Sound levels:.....
- 15.1. Vehicle in motion ~~dB(A)~~ ..... at steady speed **dB(A)**
- 15.2. At steady vehicle speed (before acceleration) of ..... (km/h)
- 15.3. Vehicle stationary .....dB(A)
- 15.4. ~~with engine running~~ at **engine speed of** .....(min-1)
- 16. **In use compliance reference data**
- 16.1. **Gear (i) for vehicles with manual transmission:** .....
- 16.2. **Vehicle speed at the beginning of the period of acceleration (average of 3 runs) for gear (i):** ..... **km/h**
- 16.3. **Sound pressure level  $L_{(i)}$ :** ..... **dB(A)**
- ~~19.~~ ~~Deviations in calibration of sound level meter:~~ .....
- ~~20.~~ 17. Vehicle submitted for approval on: .....
- ~~21.~~ 18. Technical Service responsible for conducting approval tests: .....
- ~~22.~~ 19. Date of report issued by that Service: .....
- ~~23.~~ 20. Number of report issued by that Service: .....
- ~~24.~~ 21. Approval granted/extended/refused/withdrawn<sup>2</sup>
- ~~25.~~ 22. Position of approval mark on the vehicle: .....
- ~~26.~~ 23. Place: .....
- ~~27.~~ 24. Date: .....
- ~~28.~~ 25. Signature: .....

- ~~29.~~ **26.** The following documents, bearing the approval number shown above, are annexed to this communication:
- (a) Drawings, diagrams and plans of the engine and of the exhaust or silencing system;
  - (b) Photographs of the engine and of the exhaust or silencing system;
  - (c) List of components, duly identified constituting the exhaust or silencing system.

## Annex 2

### Arrangements of the approval mark

Model A

(See paragraph 5.4. of this Regulation)



The above approval mark affixed to a vehicle shows that the vehicle type concerned has, with regard to its ~~noise~~ **sound** emission, been approved in the Netherlands (E 4) pursuant to Regulation No. 9 under approval No. 072439. The approval number indicates that the approval was granted according to the requirements of Regulation No. 9 as amended by the 07 series of amendments.

Model B

(See paragraph 5.5. of this Regulation)

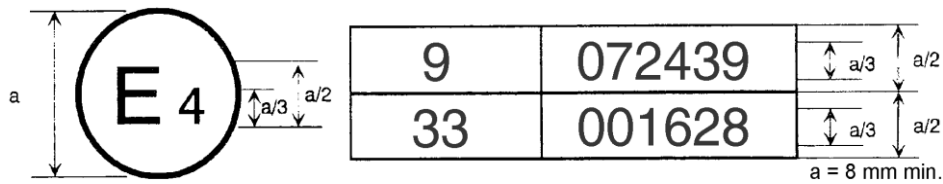

The above approval mark affixed to a vehicle shows that the vehicle type concerned has been approved in the Netherlands (E 4) pursuant to Regulations Nos. 9 and 33<sup>1</sup>. The approval numbers indicate that, at the date when the respective approvals were given, Regulation No. 9 included the 07 series of amendments and Regulation No. 33 was still in its original form.

<sup>1</sup> The second number is given merely as an example.

## Annex 3

### **Methods and instruments for measuring the noise made sound emitted by motor $L_2$ , $L_4$ and $L_5$ category vehicles**

1. Measuring instruments
  - 1.1. General

The apparatus used for measuring the sound pressure level shall be a sound level meter or equivalent measuring system meeting the requirements of Class 1 instruments (inclusive of the recommended windscreen, if used). These requirements are described in IEC 61672 1:2002. Measurements shall be carried out using the time weighting "F" of the acoustic measuring instrument and the "A" frequency weighting curve also described in IEC 61672-1:2002. When using a system that includes periodic monitoring of the A-weighted sound pressure level, a reading should be made at a time interval not greater than 30 ms. The instruments shall be maintained and calibrated in accordance with the instructions of the instrument manufacturer.
  - 1.2. Calibration

At the beginning and at the end of every measurement session, the entire acoustic measuring system shall be checked by means of a sound calibrator that fulfils the requirements of Class 1 sound calibrators according to IEC 60942:2003. Without any further adjustment, the difference between the readings shall be less than or equal to 0.5 dB(A). If this value is exceeded, the results of the measurements obtained after the previous satisfactory check shall be discarded.
  - 1.3. Compliance with requirements

Compliance of the sound calibrator with the requirements of IEC 60942:2003 shall be verified once a year. Compliance of the instrumentation system with the requirements of IEC 61672-1:2002 shall be verified at least every 2 years. All compliance testing shall be conducted by a laboratory which is authorized to perform calibrations traceable to the appropriate standards.
  - 1.4. Instrumentation for speed measurements

The rotational speed of the engine shall be measured with an instrument meeting specification limits of at least  $\pm 2$  per cent or better at the engine speeds required for the measurements being performed.

The road speed of the vehicle shall be measured with instruments meeting specification limits of at least  $\pm 0.5$  km/h when using continuous measuring devices. If testing uses independent measurements of **vehicle** speed, this instrumentation shall meet specification limits of at least  $\pm 0.2$  km/h.<sup>1</sup>

---

<sup>1</sup> Independent measurements of speed are when two or more separate devices will determine the values of vAA' and vBB'. A continuous measuring device such as radar will determine all required speed information with one device.

1.5. Meteorological instrumentation

The meteorological instrumentation used to monitor the environmental conditions during the test shall meet the following specifications:

±1 °C or less for a temperature measuring device;

±1.0 m/s for a wind speed measuring device;

±5 hPa for a barometric pressure measuring device;

±5 per cent for a relative humidity measuring device.

2. Conditions of measurement

**2.1 Test site, weather conditions and background noise level correction**

**2.1.1 Test site**

**The test site shall consist of a central acceleration track surrounded by a substantially level test area. The test track shall be level; the track surface shall be dry and so designed that tyre sound remains low.**

**On the test site, free sound field conditions shall be maintained to within ±1 dB between the sound source placed in the middle of the acceleration section and the microphone. This condition shall be deemed to be met if there are no large sound-reflecting objects such as fences, rocks, bridges or buildings within 50 m of the centre of the acceleration section. The surface of the test track shall conform to the requirements of Annex 5 to this Regulation.**

**No obstacle likely to affect the sound field shall be close to the microphone and no one shall come between the microphone and the sound source. The observer taking the measurements shall take up position so as to avoid influencing the metre readings.**

**The surface of the test track shall conform to the requirements of Annex 5 to this Regulation or to ISO10844:2014. After the end of the period indicated in paragraph 11.8. of this Regulation only ISO 10844:2014 shall be used as reference.**

**2.1.2. Weather conditions and background noise correction**

**Measurements shall not be made in poor weather conditions. The tests shall not be carried out if the wind speed, including gusts, exceeds 5 m/s during the sound-measurement interval.**

**For measurement purposes, the weighted sound level (A) of sound sources other than on the test vehicle and the sound level produced by the effect of the wind shall be at least 10 dB(A) below the sound level produced by the vehicle. The microphone may be fitted with a suitable wind guard, provided that its influence on the sensitivity and directional characteristics of the microphone are taken into account.**

**If the difference between ambient noise and measured sound levels is between 10 and 15 dB(A), in order to calculate the test result, the appropriate correction shall be subtracted from the readings on the sound level meter, as given in Table 1.**



**Table 1. Correction applied to individual measured test value**

<i>Background sound pressure level difference to measured sound pressure level, in dB</i>	<i>10</i>	<i>11</i>	<i>12</i>	<i>13</i>	<i>14</i>	<i>≥ 15</i>
<b>Correction, in dB(A)</b>	<b>0.5</b>	<b>0.4</b>	<b>0.3</b>	<b>0.2</b>	<b>0.1</b>	<b>0.0</b>

2.42. Condition of the vehicle

2.42.1. General conditions

The vehicle shall be supplied as specified by the vehicle manufacturer.

Before the measurements are started, the vehicle shall be brought to its normal operating conditions as regards:

- **Temperatures;**
- **Tuning;**
- **Fuel;**
- **Sparking plugs, carburettor(s), etc., (as appropriate).**

If the vehicle is fitted with fans with an automatic actuating mechanism, this system shall not be interfered with during the sound measurements.

**If the vehicle is equipped with devices which are not necessary for its propulsion, but which are used whilst the vehicle is in normal service on the road, those devices shall be in operation in accordance with the specifications of the manufacturer.**

For vehicles having more than one driven wheel, only the drive provided for normal road operation may be used. If the vehicle is fitted with a trailer or a semi-trailer, this shall be removed for the purposes of the test.

~~The tests shall not be carried out if the wind speed, including gusts, exceeds 5 m/s during the sound measurement interval.~~

2.42.2. Test mass of the vehicle

**The vehicle shall be tested with its test mass as defined in paragraph 2.9. of this Regulation.**

~~Measurements shall be made on vehicles at the following test mass  $m_t$ , in kg, specified as:~~

$$\del m_t = m_{kerb} \pm 75 \pm 5 \text{ kg}$$

~~where:~~

~~75 ± 5 kg equates to mass of the driver and instrumentation~~

~~$m_{kerb}$  = kerb mass~~

2.42.3. Tyre selection and condition

The tyres shall be appropriate for the vehicle and shall be inflated to the pressure recommended by the vehicle manufacturer for the test mass of the vehicle.

The tyres shall be selected by the vehicle manufacturer, and correspond to one of the tyre sizes and types designated for the vehicle by the vehicle

manufacturer. The minimum tread depth shall be at least 80 per cent of the full tread depth.

~~2.2. The test site shall consist of a central acceleration track surrounded by a substantially level test area. The test track shall be level; the track surface shall be dry and so designed that tyre noise remains low.~~

~~On the test site, free sound field conditions shall be maintained to within  $\pm 1$  dB between the sound source placed in the middle of the acceleration section and the microphone. This condition shall be deemed to be met if there are no large sound reflecting objects such as fences, rocks, bridges or buildings within 50 m of the centre of the acceleration section. The surface of the test track shall conform to the requirements of Annex 4 to this Regulation.~~

~~No obstacle likely to affect the sound field shall be close to the microphone and no one shall come between the microphone and the sound source. The observer taking the measurements shall take up position so as to avoid influencing the metre readings.~~

~~2.3. Miscellaneous~~

~~Measurements shall not be made in poor weather conditions.~~

~~For measurement purposes, the weighted sound level (A) of sound sources other than on the test vehicle and the sound level produced by the effect of the wind shall be at least 10 dB(A) below the noise level produced by the vehicle. The microphone may be fitted with a suitable wind guard, provided that its influence on the sensitivity and directional characteristics of the microphone are taken into account.~~

~~If the difference between ambient and measured noise levels is between 10 and 15 dB(A), in order to calculate the test result the appropriate correction shall be subtracted from the readings on the sound level meter, as given in Table 1.~~

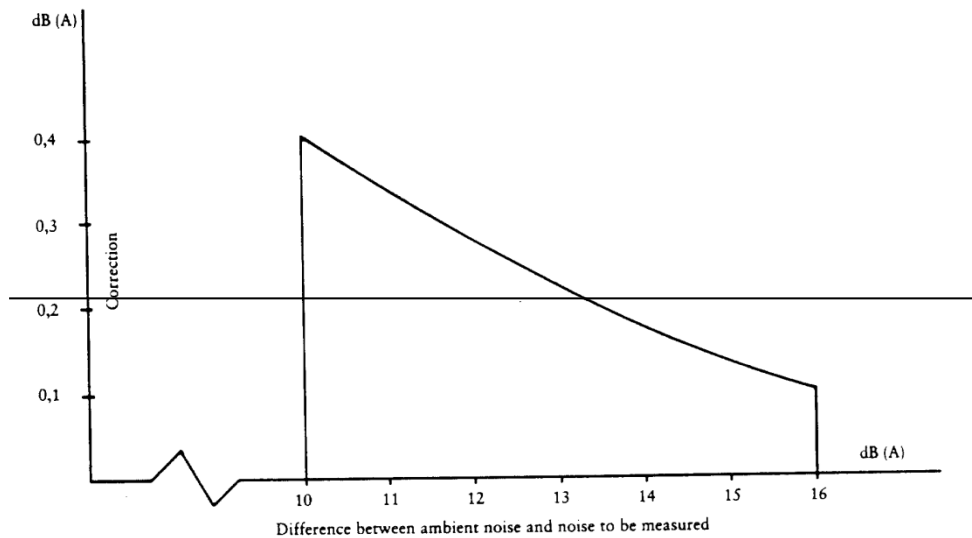

Table 1  
**Correction applied to individual measured test value**

<i>Background sound pressure level difference to measured sound pressure level, in dB</i>	<i>-10</i>	<i>-11</i>	<i>-12</i>	<i>-13</i>	<i>-14</i>	<i>≥ -15</i>
<b>Correction, in dB(A)</b>	<b>0.5</b>	<b>0.4</b>	<b>0.3</b>	<b>0.2</b>	<b>0.1</b>	<b>0.0</b>

3. Methods of measurement

3.1. Measurement of ~~noise~~ **the sound emission of the vehicles in motion**

3.1.1. **Test arrangement and microphone positions**

3.1.1.1. **The test arrangement is shown in figure 1.**

Two lines, AA' and BB', parallel to the microphone line PP' and situated respectively 10 m forward and 10 m rearward of that line shall be marked out on the test track.

3.1.1.2. **The distance of the microphone positions from the line CC', on the microphone line PP', perpendicular to the reference line CC' on the test track (see Figure 1), shall be  $7.5 \pm 0.05$  m.**

The microphones shall be located  $1.2 \pm 0.02$  m above the ground level. The reference direction for free-field conditions (see IEC 61672-1:2002) shall be horizontal and directed perpendicularly towards the path of the vehicle line CC'.

~~3.1.1.3. Two lines, AA' and BB', parallel to the microphone line PP' and situated respectively 10 m forward and 10 m rearward of that line shall be marked out on the test track.~~

3.1.2. **Acceleration test execution, approach vehicle speed and gear use**

3.1.2.1. **Acceleration test execution**

The vehicle shall approach line AA' at an initial steady vehicle speed  $v_{AA'}$  as specified below. When the front of the vehicle reaches line AA' the accelerator handle shall be fully opened as quickly as practically possible and kept in that position until the rear of the vehicle reaches the line BB'; the accelerator handle shall then be returned as quickly as possible to the idle position. The vehicle speed achieved, when the rear of the vehicle reaches the line BB' is called  $v_{BB'}$ .

The engine speeds corresponding to  $v_{AA'}$  and  $v_{BB'}$  in a specific test condition are called  $n_{AA'}$  and  $n_{BB'}$ .

In the case of articulated vehicles consisting of two non-separable units regarded as a single vehicle, the semi-trailer shall be disregarded in determining when line BB' is crossed.

For all measurements, the vehicle shall be driven in a straight line along the test track in such a way that the track of the median longitudinal plane of the vehicle is as close as possible to the line CC'.

Figure 1: Measuring positions for vehicles in motion

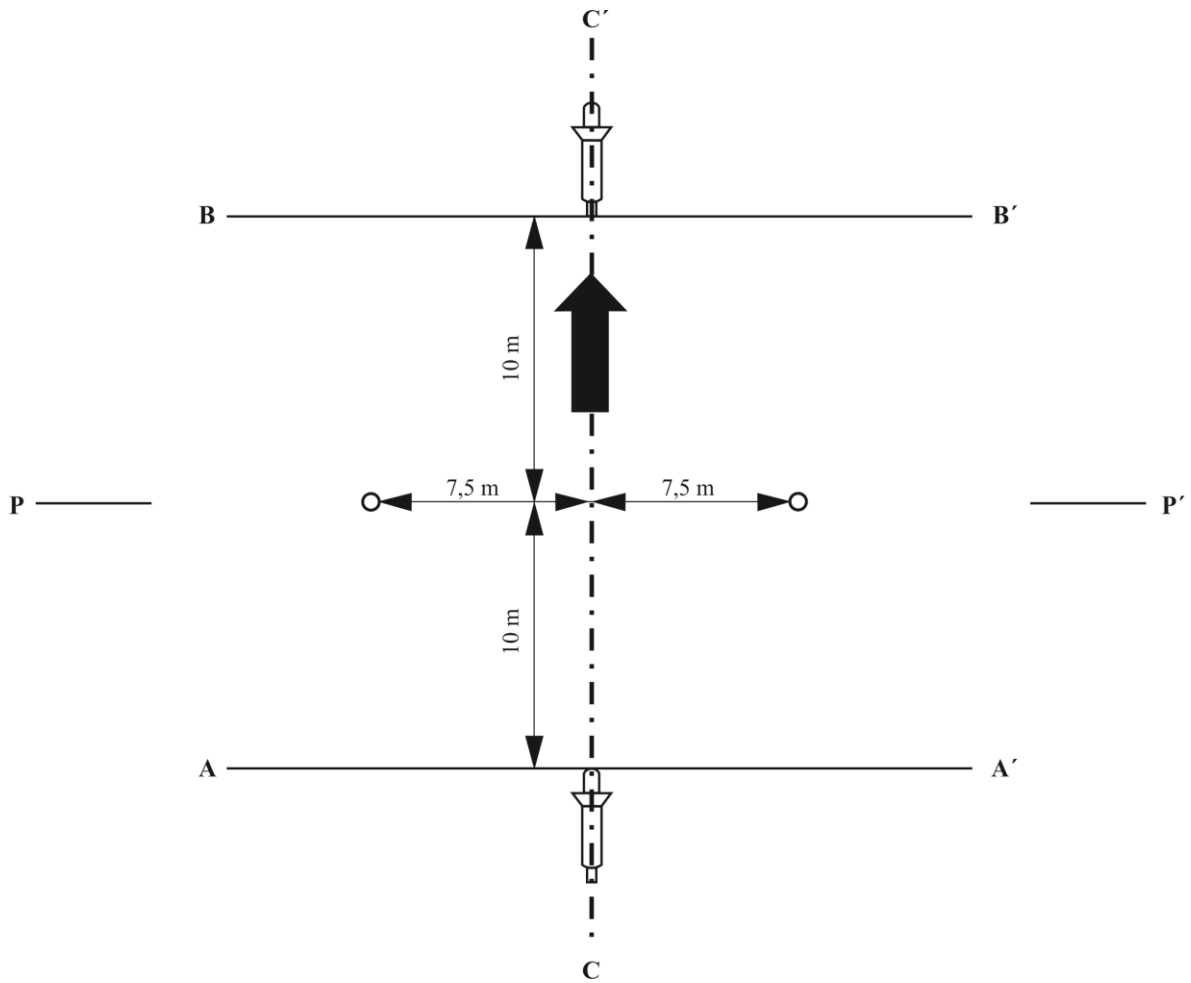

**3.1.2.2. Determination of the approach vehicle speed and the gear use**

**3.1.2.2.1. Vehicle with no gearbox**

The vehicle shall approach line AA' at a steady vehicle speed  $v_{AA'}$  corresponding either, in terms of engine speed, ( $\text{min}^{-1}$ ) to 75 per cent of the rated engine speed as defined in paragraph 2.4. of this Regulation, or to 75 per cent of the maximum engine speed permitted by the governor, or to 50 km/h, whichever is the lowest.

**3.1.2.2.2. ~~Vehicle with a manually operated gearbox~~ Vehicles with manual transmissions, automatic transmissions, or transmissions with continuously variable transmission ratios (CVT's) tested with locked gears**

If the vehicle is fitted with a dual mode transmission (e.g. low and high), the mode for normal on-road operation shall be selected.

If the vehicle is fitted with a gearbox with two or three or four forward gears or the same number of lockable gears in automatic transmission or

in CVT, the second gear shall be used. If the gearbox has more than four forward gears or the same number of lockable gears in automatic transmission or in CVT, the third gear shall be used.

The vehicle shall approach line AA' at a steady vehicle speed  $v_{AA'}$  corresponding either, in terms of engine speed, to 75 per cent of the rated engine speed as defined in paragraph 2.4. of this Regulation or to 75 per cent of the maximum engine speed permitted by the governor, or to 50 km/h, whichever is the lowest.

If, by following the above procedure, the engine speed  $n_{BB'}$ , achieved when the rear of the vehicle passes the line BB', exceeds the rated engine speed as defined in paragraph 2.4. of this Regulation, the first higher gear (or locked gear) which ensures that the rated engine speed is no longer exceeded up to the line BB' of the measurement area should be used instead of the second or third gear.

Auxiliary step-up ratios ("overdrive") shall not be engaged.

- 3.1.2.2.3. ~~Vehicle with an automatic transmission~~ Vehicles with automatic transmissions, adaptive transmissions or transmissions with variable transmission ratios tested with non-locked gears

The gear selector position for full automatic operation shall be used.

Where several full automatic operation modes are available (e.g. economic, sporty), that mode shall be selected which results in the highest average acceleration of the vehicle between lines AA' and BB'.

The test may then include a gear change to a lower gear and a higher acceleration. A gear change to a higher gear and a lower acceleration is not allowed. In any case, a gear change to a gear which is typically not used at the specified condition in urban traffic shall be avoided.

Therefore, it is permitted to establish and use electronic or mechanical devices, including alternative gear selector positions, to prevent a downshift to a gear which is typically not used at the specified test condition in urban traffic. The functionality of the devices shall be described in the communication form.

The vehicle shall approach the line AA' at a steady vehicle speed  $v_{AA'}$  of 50 km/h or at 75 per cent of its maximum vehicle speed as defined in paragraph 2.8. of this Regulation, whichever is the lower.

- 3.1.3. Sound level determination

The maximum sound level recorded at each side of the vehicle shall be reduced by 1 dB(A) to account for measurement inaccuracy and mathematically rounded to the nearest first decimal place (e.g. XX.X). These values constitute the results of the measurement.

The measurement will be invalid if an abnormal discrepancy is recorded between the peak value and the general sound level.

At least two measurements shall be made on each side of the vehicle.

The measurements shall be considered valid if the difference between the results of the two consecutive measurements on the same side of the vehicle is not more than 2 dB(A).

Preliminary measurements may be made for adjustment purposes, but shall be disregarded for the determination of the measurement results.

#### 3.1.4. Calculation of the final test result

The final test result is the average of the four test results rounded off to the nearest whole decibel. If the figure following the decimal point is between 0 and 4, the total is rounded down and if it is between 5 and 9, it is rounded up.

In case of hybrid electric vehicles, the final result is the highest of the test results for conditions A and B as described in paragraph 6.2.1.1. of this Regulation.

##### ~~3.1.1. Positions for the test~~

~~3.1.1.1. The maximum weighted sound level (A), expressed in decibels (dB), shall be measured as the vehicle is driven between lines AA' and BB' (Figure 1). The measurement shall be invalid if an abnormal discrepancy between the peak value and the general sound level is recorded.~~

~~At least two measurements shall be made on each side of the vehicle.~~

~~Preliminary measurements may be made for adjustment purposes, but shall be disregarded.~~

~~3.1.1.2. The distance of the microphone positions from the line CC', on the microphone line PP', perpendicular to the reference line CC' on the test track (Figure 1 of Appendix to this annex), shall be  $7.5 \pm 0.05$  m.~~

~~The microphones shall be located  $1.2 \pm 0.02$  m above the ground level. The reference direction for free field conditions (see IEC 61672 1:2002) shall be horizontal and directed perpendicularly towards the path of the vehicle line CC'.~~

~~3.1.1.3. Two lines, AA' and BB', parallel to line PP' and situated respectively 10 m forward and 10 m rearward of that line shall be marked out on the test runway. The vehicle shall approach line AA' at a steady speed as specified below. The throttle shall then be fully opened as rapidly as practicable and held in the fully opened position until the rear of the vehicle crosses line BB'; the throttle shall then be closed again as rapidly as possible.~~

~~3.1.1.4. In the case of articulated vehicles consisting of two non separable units regarded as a single vehicle, the semi trailer shall be disregarded in determining when line BB' is crossed.~~

~~3.1.1.5. The values, rounded off to the nearest whole decibel, shall be taken from the measuring apparatus. If the figure following the decimal point is between 0 and 4, the total is rounded down and if between 5 and 9, it is rounded up.~~

~~Only values which are obtained from two consecutive measurements on the same side of the vehicle, and do not differ by more than 2 dB(A), shall be accepted.~~

~~The result of the measurement shall be determined in accordance with paragraph 4. of this annex.~~

~~3.1.2. Determination of the steady speed~~

~~3.1.2.1. Vehicle with no gearbox~~

~~The vehicle shall approach line AA' at a steady speed corresponding either, in terms of engine speed, ( $\text{min}^{-1}$ ) to three quarters of the rated engine speed, or to three quarters of the maximum engine speed permitted by the governor, or to 50 km/h, whichever is the lowest.~~

~~3.1.2.2. Vehicle with a manually operated gearbox~~

~~If the vehicle is fitted with a two speed, a three speed or a four speed gearbox, the second gear shall be used. If the vehicle has more than four speeds, the third gear shall be used. If, by following the above procedure, the engine speed developed exceeds its maximum permissible regime, the first higher gear which ensures that this regime is no longer exceeded up to the line BB' of the measurement area should be used instead of the second or third gear. Auxiliary step up ratios ("overdrive") shall not be engaged. If the vehicle is fitted with a differential with two gear ratios, the ratio selected shall be that allowing the highest vehicle speed. The vehicle shall approach line AA' at a steady speed corresponding either, in terms of engine speed, to three quarters of the rated engine speed or to three quarters of the maximum engine speed permitted by the governor, or to 50 km/h, whichever is the lowest.~~

~~3.1.2.3. Vehicle with an automatic transmission~~

~~The vehicle shall approach the line AA' at a steady speed of 50 km/h or at three quarters of its maximum speed, whichever is the lower. Where several forward drive positions are available, that position shall be selected which results in the highest mean acceleration of the vehicle between lines AA' and BB'. The selector position which is used only for engine braking, parking or similar slow manoeuvres shall not be used.~~

3.2. Measurement of ~~noise~~ **the sound emitted by** ~~of~~ stationary vehicles (for testing of vehicles ~~in service in use~~)

3.2.1. ~~Acoustic~~ **Sound** pressure level close to **the outlet(s) of the exhaust system** ~~vehicles~~

In addition, so as to facilitate the subsequent testing of vehicles ~~in service in use~~, the ~~acoustic sound~~ **sound** pressure level shall be measured near the outlet of the exhaust system (silencing system), in conformity with the requirements set out below, and the result of the measurement shall be included in the test report prepared for the issuance of the document referred to in Annex 1 to this Regulation.

3.2.2. Measuring instruments

The measurements shall be made using a precision sound level meter in accordance with paragraph 1. of this annex.

3.2.3. Conditions for measurements

3.2.3.1. Condition of the vehicle

Before the measurements are started, the vehicle engine shall be brought to its normal operating temperature. If the vehicle is equipped with automatic fans, no adjustment shall be made to them during the measurement of the ~~noise~~ **sound** level.

While measurements are being made, the gear lever shall be in neutral. If the transmission cannot be disconnected, the drive wheel of the vehicle should be

allowed to run under no-load conditions by, for example, placing the vehicle on a support or on rollers.

3.2.3.2. Test site

Any area not subject to major acoustic perturbations may be used as a test site. Level areas covered with concrete, asphalt or some other hard material and are highly reflective are suitable; surfaces consisting of earth which has been tamped down shall not be used. The test site shall have at least the dimensions of a rectangle the sides of which shall be 3 m from the outline of the vehicle (excluding handlebars). No significant obstacle such as a person other than the observer and the driver shall be within this rectangle.

The vehicle shall be placed within the above-mentioned rectangle in such a way that the measuring microphone is at least one metre from any stone edging.

3.2.3.3. Miscellaneous

Instrument readings caused by ambient or wind noise shall be at least 10 dB(A) less than the ~~noise~~ **sound** level to be measured. The microphone may be fitted with a suitable wind-guard provided that its effect on microphone sensitivity is taken into account.

3.2.4. Method of measurement

3.2.4.1. Number of measurements

At least three measurements shall be made at each measurement point. The measurements shall be considered valid only if the difference between the results of three consecutive measurements is not more than 2 dB(A).

3.2.4.2. Positioning of the microphone (see Figure 2 ~~of Appendix to this annex~~)

The microphone shall be located at a distance of  $0.5 \pm 0.01$  m from the reference point of the exhaust pipe defined in Figure 3 ~~Figure 4 of Appendix to this annex~~ and at an angle of  $45 \pm 5^\circ$  to the vertical plane containing the flow axis of the pipe termination. The microphone shall be at the height of the reference point, but not less than 0.2 m from the ground surface. The reference axis of the microphone shall lie in a plane parallel to the ground surface and shall be directed towards the reference point on the exhaust outlet.



Figure 2: Microphone positions for the measurement of sound of the stationary vehicle

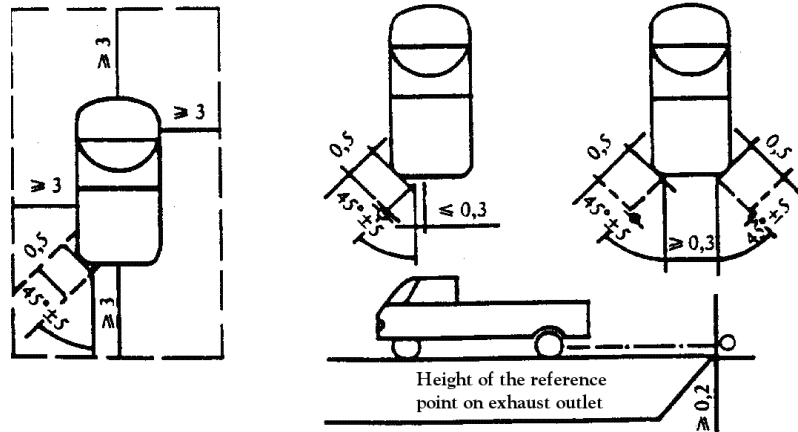
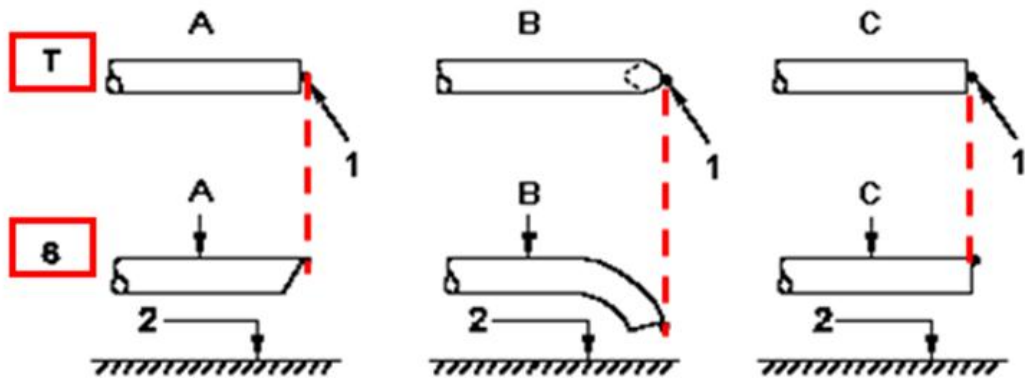

Figure 3: Reference point



**Key**

- T** top view
- S** side view

- 1** reference point
- 2** road surface

- A** mitered pipe
- B** bent down pipe
- C** straight pipe
- D** vertical pipe

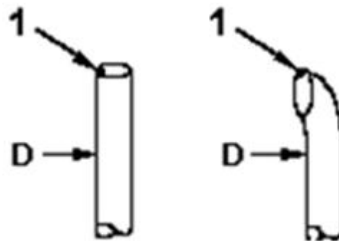

The reference point shall be the highest point satisfying the following conditions:

- (a) The reference point shall be at the end of the exhaust pipe,
- (b) The reference point shall be on the vertical plane containing the exhaust outlet centre and the flow axis of the exhaust pipe termination.

If two microphone positions are possible, the location farthest laterally from the vehicle longitudinal centreline shall be used.

If the flow axis of the exhaust outlet pipe is at  $90^\circ \pm 5^\circ$  to the vehicle longitudinal centreline, the microphone shall be located at the point that is the furthest from the engine.

If a vehicle has two or more exhaust outlets spaced less than 0.3 m apart and connected to a single silencer, only one measurement shall be made. The microphone shall be located relative to the outlet the farthest from the vehicle's longitudinal centreline, or, when such outlet does not exist, to the outlet that is highest above the ground.

For vehicles having an exhaust provided with outlets spaced more than 0.3 m apart, one measurement is made for each outlet as if it were the only one, and the highest sound pressure level shall be noted.

For the purpose of roadside checking, the reference point may be moved to the outer surface of the vehicle body.

For vehicles equipped with multiple exhaust outlets, the reported sound pressure level shall be for the outlet having the highest average sound pressure level.

#### 3.2.4.3. Operating conditions

The engine speed shall be held steady at one of the following values:

~~1/2~~ **50 per cent of  $n_{\text{rated}}$**  ~~if  $n_{\text{rated}}$  exceeds 5,000  $\text{min}^{-1}$~~

~~3/4~~ **75 per cent of  $n_{\text{rated}}$**  ~~if  $n_{\text{rated}}$  does not exceed 5,000  $\text{min}^{-1}$~~

Where  $n_{\text{rated}}$  is the rated engine speed **as defined in paragraph 2.4. of this Regulation. at which the engine produces its maximum power.**

For a vehicle which cannot reach, in a stationary test, the target engine speed defined above, 95 per cent of the maximum engine speed reachable in a stationary test shall be used instead as target engine speed.

The engine speed shall be gradually increased from idle to the target engine speed and held constant within a tolerance band of  $\pm 5$  per cent. Then the throttle control shall be rapidly released and the engine speed shall be returned to idle. The sound pressure level shall be measured during a period consisting of constant engine speed of at least 1 s and throughout the entire deceleration period. The maximum sound level meter reading shall be taken as the test value.

A measurement shall be regarded as valid only if the test engine speed did not deviate from the target engine speed by more than the specified tolerance of  $\pm 5$  per cent for at least 1 s.

#### 3.2.4.4. Measurements shall be made at the microphone location(s) prescribed above. The maximum A-weighted sound pressure level indicated during the test shall be noted, retaining one significant figure behind the decimal place (e.g. 92.45 shall be noted as to 92.5 while 92.44 shall be noted as to 92.4).

The test shall be repeated until three consecutive measurements that are within 2.0 dB(A) of each other are obtained at each outlet.

The **test** result for a given outlet is the arithmetic average of the three valid measurements, mathematically rounded to the nearest integer value (e.g. 92.5 shall be noted as to 93 while 92.4 shall be noted as to 92).

#### 3.2.4.5. Multi-mode exhaust system

- 3.2.4.5.1. Vehicles equipped with a multiple mode, manually adjustable exhaust system shall be tested in all modes.
- 3.2.4.5.2. For vehicles equipped with a multi-mode exhaust system and a manual exhaust mode control the reported sound pressure level shall be for the mode having the highest average sound pressure level.
- ~~4. Interpretation of results for vehicles in motion~~
- ~~The values taken shall be rounded off to the nearest whole decibel. If the figure following the decimal point is between 0 and 4, the total is rounded down and if between 5 and 9, it is rounded up.~~
- ~~Only the values of readings obtained from two consecutive measurements made on the same side of the vehicle and not differing by more than 2 dB(A) shall be accepted.~~
- ~~To allow for lack of precision in the readings, the result of each measurement shall be taken as equal to the value obtained, minus 1 dB(A).~~
- ~~If the average of the four readings does not exceed the maximum permissible level for the category to which the tested vehicle belongs, the limit specified in paragraph 6.2.1.3 of this Regulation shall be deemed as being complied with. This average value shall constitute the test result.~~
- 4. Sound from the vehicle in motion (data reported to facilitate testing of the vehicle in use).**
- 4.1. A test procedure for in use compliance tests may be defined by a Contracting Party, taking due account of any differences from the test conditions used at type-approval.**
- 4.2. In order to facilitate in use compliance test of vehicles, the following information relating to the sound-pressure level measurements carried out in accordance with paragraph 1. of Annex 3 for the vehicle in motion is referred to as in use compliance reference data:**
- (a) Gear (i) or, for vehicles tested with non-locked gear ratios, the position of the gear selector chosen for the test;
- (b) The vehicle speed  $v_{AA}$  in km/h at the beginning of the full throttle acceleration test in gear (i); and
- (c) The final test result in dB(A) as determined according to paragraph 3.1.4. of this annex.
- 4.3. The in use compliance reference data shall be entered in the communication form conforming to Annex 1.**
5. Original exhaust (silencing) system
- 5.1. Requirements for silencers containing absorbent fibrous materials
- 5.1.1. Fibrous absorbent material shall be asbestos-free and may be used in the construction of silencers only if suitable devices ensure that the fibrous absorbent material is kept in place for the whole time that the silencer is being used and the exhaust or silencing system meets the requirements of any one of paragraphs 5.1.2., 5.1.3. or 5.1.4. below.
- 5.1.2. After removal of the fibrous material, the sound-level shall conform to the requirements of paragraph 6.2.1.3. of this Regulation.

- 5.1.3. The fibrous absorbent material may not be placed in those parts of the silencer through which the exhaust gases pass and shall conform to the following requirements:
  - 5.1.3.1. The material shall be heated at a temperature of  $650 \pm 5$  °C for four hours in a furnace without reduction in the average length, diameter or bulk density of the fibre;
  - 5.1.3.2. After heating at  $650 \pm 5$  °C for one hour in a furnace, at least 98 per cent of the material shall be retained in a sieve of nominal aperture size 250 µm conforming to ISO standard 3310/1: ~~1999~~**2000** when tested in accordance with ISO standard 2559:~~2000~~**2011**.
  - 5.1.3.3. The loss in weight of the material shall not exceed 10.5 per cent after soaking for 24 h at  $90 \pm 5$  °C in a synthetic condensate of the following composition:
    - 1 N hydrobromic acid (HBr) 10 ml
    - 1 N sulphuric acid (H<sub>2</sub>SO<sub>4</sub>) 10 ml
    - Distilled water to make up to 1,000 ml

*Note:* The material must be washed in distilled water and dried for one hour at 105 °C before weighing.

5.1.4. Before the system is tested in accordance with paragraph 3. above, it shall be put into a normal state for road use by one of the following methods:

5.1.4.1. Conditioning by continuous road operation

5.1.4.1.1. Depending on the ~~category~~**engine capacity of the** vehicle, the minimum distances to be completed during conditioning shall be:

<i>Category of vehicle according to cylinder capacity in cm<sup>3</sup></i>	<i>Distance (km)</i>
1. ≤ 250	4 000
2. > 250 ≤ 500	6 000
3. > 500	8 000

5.1.4.1.2. 50 per cent ± 10 per cent of this conditioning cycle shall consist of town driving and the remainder of long-distance runs at high **vehicle** speed; the continuous road cycle may be replaced by a corresponding test-track programme;

5.1.4.1.3. The two **vehicle** speed regimes shall be alternated at least six times;

5.1.4.1.4. The complete test programme shall include a minimum of 10 breaks of at least 3 h duration in order to reproduce the effects of cooling and condensation.

5.1.4.2. Conditioning by pulsation

5.1.4.2.1. The exhaust system or components thereof shall be fitted to the vehicle or to the engine.

In the former case, the vehicle shall be mounted on a roller dynamometer. In the second case, the engine shall be mounted on a test bench.

The test apparatus, a detailed diagram of which is shown in Figure 3 4 of Appendix to this annex, shall be fitted at the outlet of the exhaust system. Any other apparatus providing equivalent results shall be acceptable.

Figure 4. Test apparatus for conditioning by pulsation

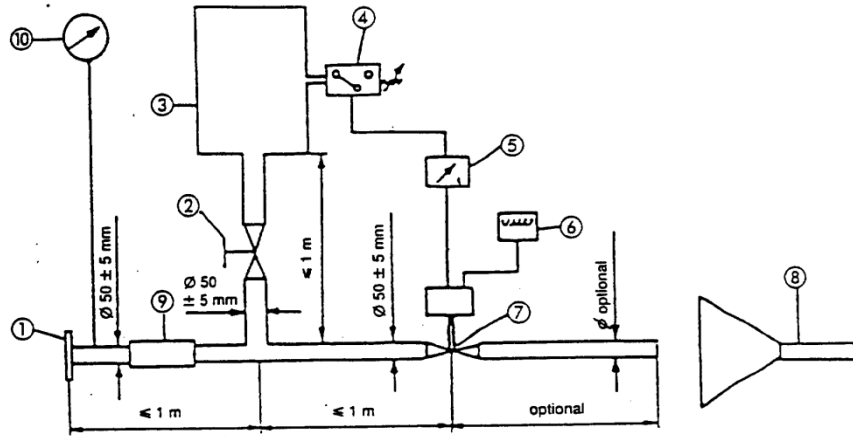

1. Inlet flange or sleeve for connection to the rear of the test exhaust system
2. Hand-operated regulating valve.
3. Compensating reservoir with a maximum capacity of 40 l and a filling time of not less than one second.
4. Pressure switch with an operating range of 5 to 250 kPa.
5. Time delay switch.
6. Pulse counter.
7. Quick-acting valve, such as exhaust brake valve 60 mm in diameter, operated by a pneumatic cylinder with an output of 120 N at 400 kPa. The response time, both when opening and closing, shall not exceed 0.5 seconds.
8. Exhaust gas evacuation.
9. Flexible pipe.
10. Pressure gauge.

5.1.4.2.2. The test equipment shall be adjusted so that the flow of exhaust gases is alternately interrupted and restored 2,500 times by a rapid-action valve.

5.1.4.2.3. The valve shall open when the exhaust gas back-pressure, measured at least 100 mm downstream of the intake flange, reaches a value of between 35 and 40 kPa. Should such a figure be unattainable because of the engine characteristics, the valve shall open when the gas back-pressure reaches a level equivalent to 90 per cent of the maximum that can be measured before the engine stops. It shall close when this pressure does not differ by more than 10 per cent from its stabilized value with the valve open.

5.1.4.2.4. The time-delay switch shall be set for the duration of exhaust gases calculated on the basis of the requirements of paragraph 5.1.4.2.3. above.

- 5.1.4.2.5. ~~Engine~~ **The engine** speed shall be 75 per cent of **the rated engine** speed **as defined in paragraph 2.4. of this Regulation.** ~~(S) at which the engine develops maximum power.~~
- 5.1.4.2.6. The power indicated by the dynamometer shall be 50 per cent of the full-throttle power measured at 75 per cent of the rated engine speed **as defined in paragraph 2.4. of this Regulation.** ~~(S).~~
- 5.1.4.2.7. Any drainage holes shall be closed off during the test.
- 5.1.4.2.8. The entire test shall be completed within 48 hours. If necessary, a cooling period shall be allowed after each hour.
- 5.1.4.3. Conditioning on a test bench
- 5.1.4.3.1. The exhaust system shall be fitted to an engine representative of the type fitted to the vehicle for which the system is designed, and mounted on a test bench.
- 5.1.4.3.2. Conditioning shall consist of the specified number of test bench cycles for the ~~category~~ **engine capacity class** of vehicle, for which the exhaust system was designed. The number of cycles for each vehicle ~~class category~~ **class** shall be:

<i>Category of vehicle according to cylinder capacity in cm<sup>3</sup></i>	<i>Number of cycles</i>
1. ≤ 250	6
2. > 250 ≤ 500	9
3. > 500	12

- 5.1.4.3.3. Each test-bench cycle shall be followed by a break of at least six hours in order to reproduce the effects of cooling and condensation.
- 5.1.4.3.4. Each test-bench cycle shall consist of six phases. The engine conditions for, and the duration of, each phase shall be:

<i>Phase</i>	<i>Conditions</i>	<i>Duration of phase</i>	
		<i>Engines of less than 250 cm<sup>3</sup></i>	<i>Engines of 250 cm<sup>3</sup> or more</i>
		<i>(min)</i>	<i>(min)</i>
1	Idling	6	6
2	25 % <del>per cent</del> load at 75 % <del>per cent of</del> <b>n<sub>rated</sub></b> <del>S</del>	40	50
3	50 % <del>per cent</del> load at 75 % <del>per cent of</del> <b>n<sub>rated</sub></b> <del>S</del>	40	50
4	100 % <del>per cent</del> load at 75 % <del>per cent of</del> <b>n<sub>rated</sub></b> <del>S</del>	30	10
5	50 % <del>per cent</del> load at 100 % <del>per cent of</del> <b>n<sub>rated</sub></b> <del>S</del>	12	12
6	25 % <del>per cent</del> load at 100 % <del>per cent of</del> <b>n<sub>rated</sub></b> <del>S</del>	22	22
	Total time	2 h 30 min	2 h 30 min

- 5.1.4.3.5. During this conditioning procedure, at the request of the manufacturer, the engine and the silencer may be cooled in order that the temperature recorded at a point not more than 100 mm from the exhaust gas outlet does not exceed that measured when the vehicle is running at 110 km/h or 75 per cent of **the rated engine speed as defined in paragraph 2.4. of this Regulation** ~~S~~ in top gear.

The engine and/or vehicle speeds shall be determined ~~to within~~ **with a tolerance of  $\pm 3$  per cent.**

5.2. Diagram and markings

5.2.1. The diagram and a dimensioned cross-section of the silencer shall be annexed to the document mentioned in Annex 1 to this Regulation.

5.2.2. **All original silencers shall bear at least the following:**

**(a) the 'E' mark followed by the reference to the country which granted the type-approval;**

**(b) the vehicle manufacturer's name or trademark; and**

**(c) the make and identifying part number.**

**This reference shall be legible, indelible and visible in the position at which it is to be fitted.**

~~All original silencing systems shall be marked with an "E" followed by the identification number of the approving country. This reference shall be clearly legible and indelible and shall also be visible after mounting.~~

5.2.3. Any packaging of original replacements for exhaust or silencing systems shall be marked legibly with the words "original part" and the make and type reference integrated together with the "E" mark and also the reference of the country of origin.

5.3. Intake silencers

If the engine intake has to be fitted with an air filter and/or intake silencer in order to comply with the permissible sound level, the filter and/or silencer shall be regarded as part of the silencer and the requirements of paragraphs 5.1. and 5.2. above shall also be applicable to them.

### Annex 3 – Appendix

Figure 1  
Positions for testing the vehicle in motion

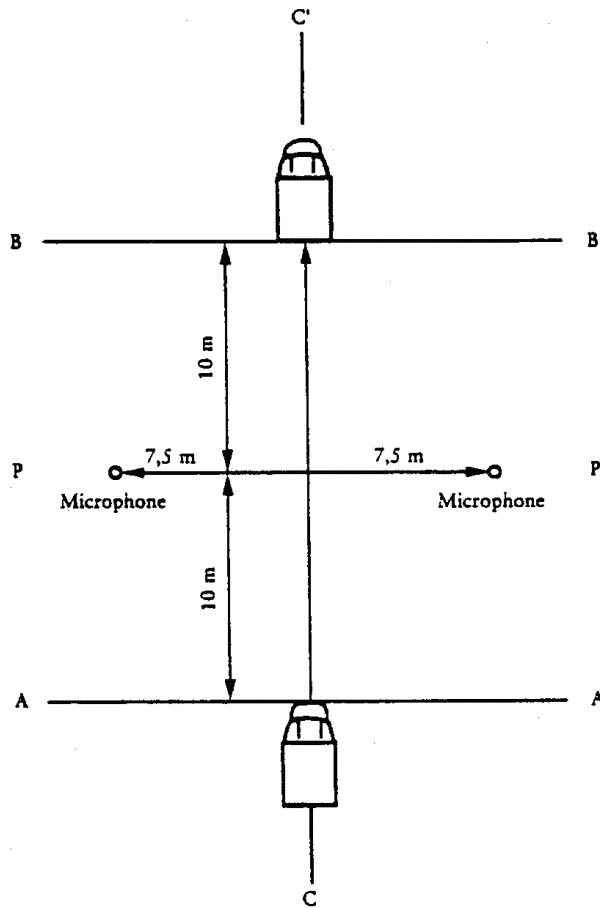

Figure 2  
Positions for testing the stationary vehicle

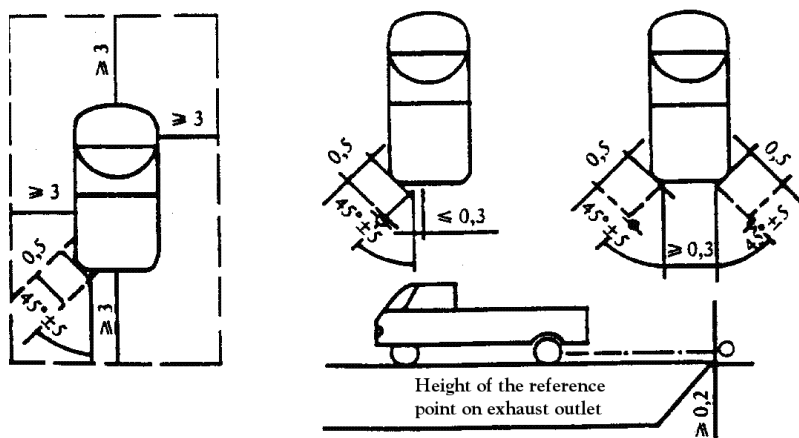
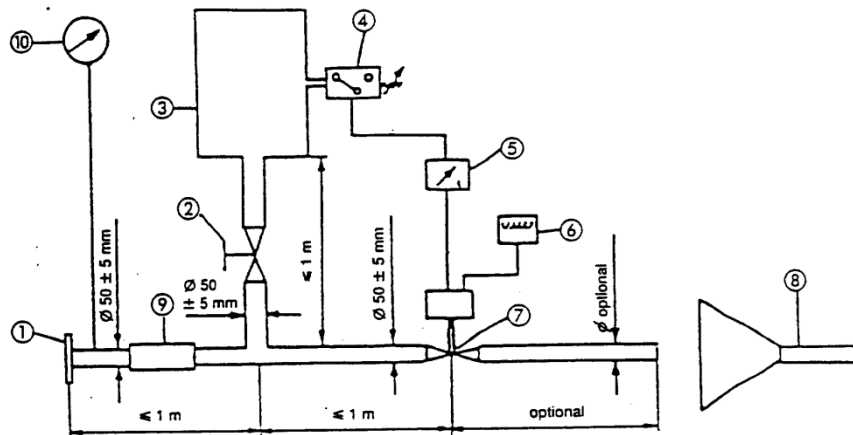

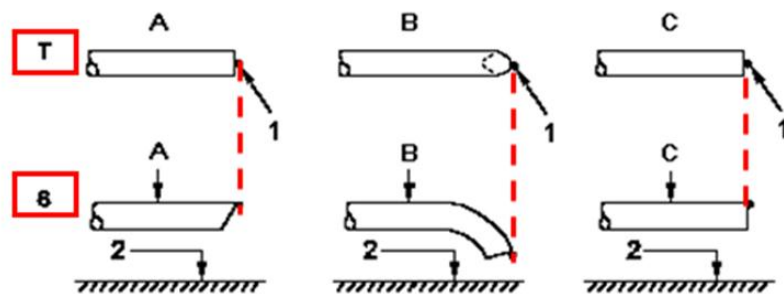

Figure 3  
**Test apparatus for conditioning by pulsation**



1. — Inlet flange or sleeve for connection to the rear of the test exhaust system
2. — Hand operated regulating valve.
3. — Compensating reservoir with a maximum capacity of 40 l and a filling time of not less than one second.
4. — Pressure switch with an operating range of 5 to 250 kPa.
5. — Time delay switch.
6. — Pulse counter.
7. — Quick acting valve, such as exhaust brake valve 60 mm in diameter, operated by a pneumatic cylinder with an output of 120 N at 400 kPa. The response time, both when opening and closing, shall not exceed 0.5 seconds.
8. — Exhaust gas evacuation.
9. — Flexible pipe.
10. — Pressure gauge.

Figure 4  
Reference point



Key

- T top view
- S side view
- 1 reference point
- 2 road surface
- A mitered pipe
- B bent down pipe
- C straight pipe
- D vertical pipe

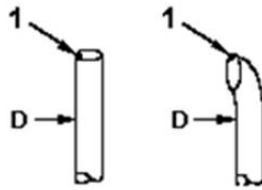

**Annex 4****Maximum sound level limits (new vehicles)**

<i>Vehicle category</i>	<i>Maximum sound level values in dB(A)</i>
<u>L<sub>2</sub></u>	76
<u>L<sub>4</sub></u>	80
<u>L<sub>5</sub></u>	80

## ~~Annex 4~~ Annex 5

### Specifications for the test site<sup>1</sup>

1. Introduction

This annex describes the specifications relating to the physical characteristics and the laying of the test track. These specifications based on a special standard<sup>2</sup> describe the required physical characteristics as well as the test methods for these characteristics.

2. Required characteristics of the surface

A surface is considered to conform to this standard provided that the texture and voids content or sound absorption coefficient have been measured and found to fulfil all the requirements of paragraphs 2.1. to 2.4. below and provided that the design requirements (paragraph 3.2. below) have been met.

2.1. Residual voids content

The residual voids content,  $V_C$ , of the test track paving mixture shall not exceed 8 per cent. For the measurement procedure, see paragraph 4.1. below.

2.2. Sound absorption coefficient

If the surface fails to conform to the residual voids content requirement, the surface is acceptable only if its sound absorption coefficient,  $\alpha \leq 0.10$ . For the measurement procedure, see paragraph 4.2. below. The requirements of paragraphs 2.1. above and this paragraph are met also if only sound absorption has been measured and found to be  $\alpha \leq 0.10$ .

*Note:* The most relevant characteristic is the sound absorption, although the residual voids content is more familiar among road constructors. However, sound absorption needs to be measured only if the surface fails to comply with the voids requirement. This is because the latter is connected with relatively large uncertainties in terms of both measurements and relevance and some surfaces therefore may be rejected erroneously on the basis of the voids measurement only.

2.3. Texture depth

The texture depth (TD) measured according to the volumetric method (see paragraph 4.3. below) shall be:

$$TD \geq 0.4 \text{ mm}$$

2.4. Homogeneity of the surface

Every practical effort shall be made to ensure that the surface is made to be as homogeneous as possible within the test area. This includes the texture and voids content, but it should also be observed that if the rolling process results in more effective rolling at some places than at others, the texture may be different and unevenness causing bumps may also occur.

---

<sup>1</sup> The specifications for the test site reproduced in this annex are valid until the end of the period indicated in paragraph 11.8. of this Regulation.

<sup>2</sup> ISO 10844:1994

2.5. Period of testing

In order to check whether the surface continues to conform to the texture and voids content or sound absorption requirements stipulated in this standard, periodic testing of the surface shall be done at the following intervals:

(a) For residual voids content or sound absorption:

When the surface is new; if the surface meets the requirements when new, no further periodical testing is required.

(b) For texture depth (TD):

When the surface is new; when the ~~noise~~ **sound** testing starts (*Note:* Not before four weeks after laying); then every 12 months.

3. Test surface design

3.1. Area

When designing the test track layout it is important to ensure that, as a minimum requirement, the area traversed by the vehicles running through the test strip is covered with the specified test material with suitable margins for safe and practical driving. This will require the width of the track to be at least 3 m and the length of the track to extend beyond lines AA and BB by at least 10 m at either end. Figure 1 shows a plan of a suitable test site and indicates the minimum area which shall be machine laid and machine compacted with the specified test surface material. According to Annex 3, paragraph 3.1.1.1., measurements have to be made on each side of the vehicle. This can be done either by measuring with two microphone locations (one on each side of the track) and driving in one direction, or measuring with a microphone only on one side of the track but driving the vehicle in two directions. If the latter method is used, then there are no surface requirements on that side of the track where there is no microphone.

Figure 1  
**Minimum requirement for test surface area. The shaded part is called "Test Area"**

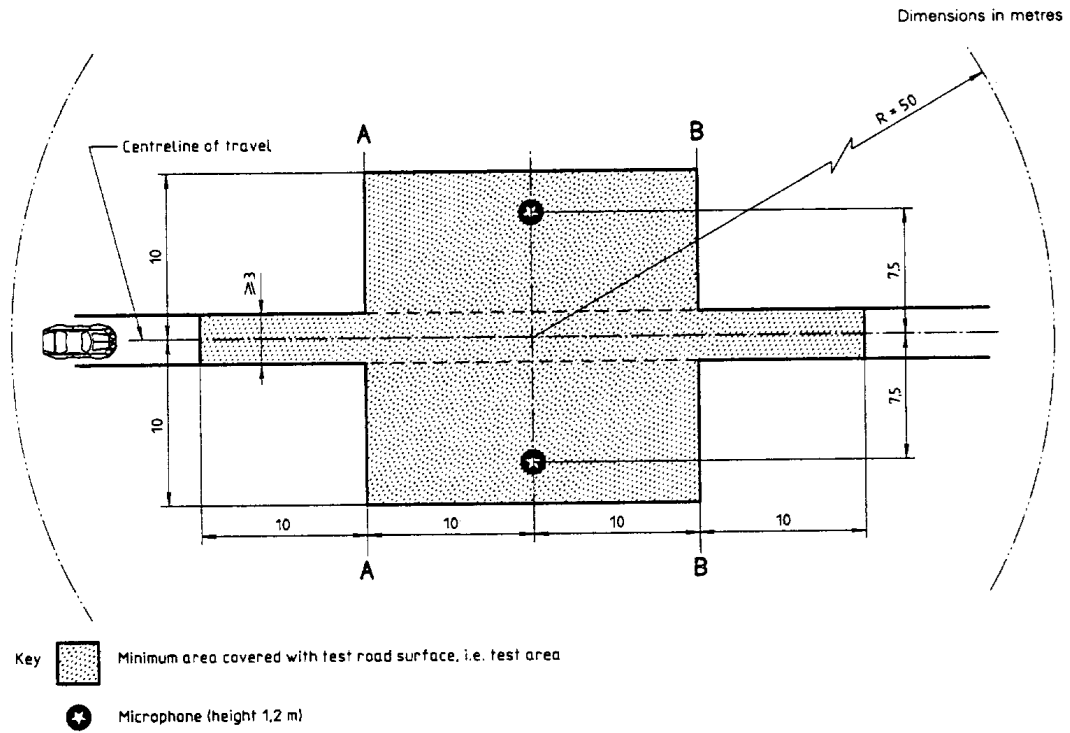

NOTE — There shall be no large acoustically reflective objects within this radius.

3.2. Design and preparation of the surface

3.2.1. Basic design requirements; the test surface shall meet four design requirements:

3.2.1.1. It shall be a dense asphaltic concrete;

3.2.1.2. The maximum chipping size shall be 8 mm (tolerances allow from 6.3 to 10 mm);

3.2.1.3. The thickness of the wearing course shall be  $\geq 30$  mm;

3.2.1.4. The binder shall be a straight penetration grade bitumen without modification.

3.2.2. Design guidelines

As a guide to the surface constructor, an aggregate grading curve which will give desired characteristics is shown in Figure 2. In addition, Table 1 gives some guidelines for obtaining the desired texture and durability. The grading curve fits the following formula:

$$P (\% \text{ passing}) = 100 \cdot (d/d_{\max})^{1/2}$$

where:

- d = square mesh sieve size, in mm
- $d_{\max}$  = 8 mm for the mean curve
- $d_{\max}$  = 10 mm for the lower tolerance curve
- $d_{\max}$  = 6.3 mm for the upper tolerance curve

Figure 2  
Grading curve of the aggregate in the asphaltic mix with tolerances

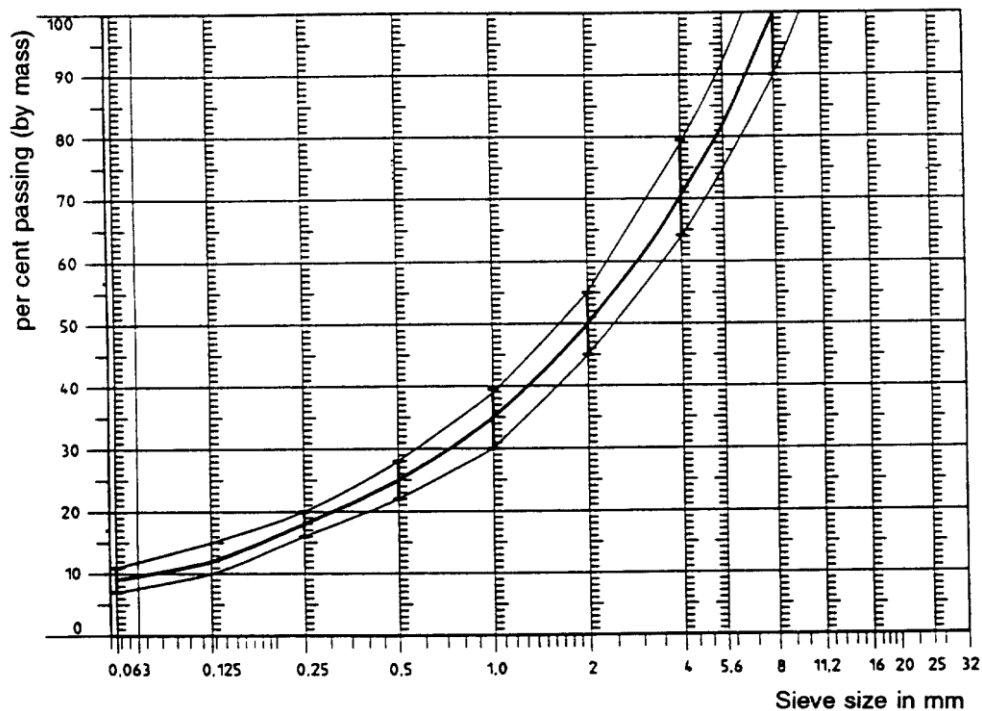

In addition to the above, the following recommendations are given:

- (a) The sand fraction (0.063 mm < square mesh sieve size < 2 mm) shall include no more than 55 per cent natural sand and at least 45 per cent crushed sand;
- (b) The base and sub-base shall ensure a good stability and evenness, according to best road construction practice;
- (c) The chippings shall be crushed (100 per cent crushed faces) and of a material with a high resistance to crushing;
- (d) The chippings used in the mix shall be washed;
- (e) No extra chippings shall be added onto the surface;
- (f) The binder hardness expressed as PEN value shall be 40-60, 60-80 or even 80-100 depending on the climatic conditions of the country. The rule is that as hard a binder as possible shall be used, provided this is consistent with common practice;
- (g) The temperature of the mix before rolling shall be chosen so as to achieve by subsequent rolling the required voids content. In order to increase the probability of satisfying the specifications of paragraphs 2.1. to 2.4. above, the compactness shall be studied not only by an appropriate choice of mixing temperature, but also by an appropriate number of passing and by the choice of compacting vehicle.

Table 1  
Design guidelines

	Target values		Tolerances
	By total mass of mix	By mass of the aggregate	
Mass of stones, square mesh sieve (SM) > 2 mm	47.6 %	50.5 %	±5
Mass of sand 0.063 < SM < 2 mm	38.0 %	40.2 %	±5
Mass of filler SM < 0.063 mm	8.8 %	9.3 %	±2
Mass of binder (bitumen)	5.8 %	N.A.	±0.5
Max. chipping size		8 mm	6.3 - 10
Binder hardness	(see paragraph 3.2.2.(f))		
Polished stone value (PSV)		> 50	
Compactness, relative to Marshall compactness		98 %	

#### 4. Test method

##### 4.1. Measurement of the residual voids content

For the purpose of this measurement, cores have to be taken from the track in at least four different positions which are equally distributed in the test area between lines AA and BB (see Figure 1). In order to avoid inhomogeneity and unevenness in the wheel tracks, cores should not be taken in wheel tracks themselves, but close to them. Two cores (minimum) should be taken close to the wheel tracks and one core (minimum) should be taken approximately midway between the wheel tracks and each microphone location.

If there is a suspicion that the condition of homogeneity is not met (see paragraph 2.4. above), cores shall be taken from more locations within the test area. The residual voids content has to be determined for each core, then the average value from all cores shall be calculated and compared with the requirement of paragraph 2.1. above. In addition, no single core shall have a voids value which is higher than 10 per cent. The test surface constructor is reminded of the problem which may arise when the test area is heated by pipes or electrical wires and cores shall be taken from this area. Such installations shall be carefully planned with respect to future core drilling locations. It is recommended that a few locations of size approximately 200 x 300 mm should be left where there are no wires/pipes or where the latter are located deep enough in order not to be damaged by cores taken from the surface layer.

##### 4.2. Sound absorption coefficient

The sound absorption coefficient (normal incidence) shall be measured by the impedance tube method using the procedure specified in ISO/DIS 10 534: "Acoustics - Determination of sound absorption coefficient and impedance by a tube method".

Regarding test specimens, the same requirements shall be followed as regarding the residual voids content (see paragraph 4.1. above).

The sound absorption shall be measured in the range between 400 Hz and 800 Hz and in the range between 800 Hz and 1,600 Hz (at least at the centre frequencies of third octave bands) and the maximum values shall be identified for both of these frequency ranges.



Then these values, for all test cores shall be averaged to constitute the final result.

4.3. Volumetric macrotexture measurement

For the purpose of this standard, texture depth measurements shall be made on at least 10 positions evenly spaced along the wheel tracks of the test strip and the average value taken to compare with the specified minimum texture depth. For the description of the procedure see standard ISO 10844:1994.

5. Stability in time and maintenance

5.1. Age influence

In common with any other surfaces, it is expected that the tyre/road **noise sound** level measured on the test surface may increase slightly during the first 6-12 months after construction.

The surface will achieve its required characteristics not earlier than four weeks after construction.

The stability over time is determined mainly by the polishing and compaction by vehicles driving on the surface. It shall be periodically checked as stated in paragraph 2.5. above.

5.2. Maintenance of the surface

Loose debris or dust which could significantly reduce the effective texture depth shall be removed from the surface. In countries with winter climates, salt is sometimes used for de-icing. Salt may alter the surface temporarily or even permanently in such a way as to increase **noise sound**, and is therefore not recommended.

5.3. Repaving the test area

If it is necessary to repave the test track, it is usually unnecessary to repave more than the test strip (of 3 m width in Figure 1) where vehicles are driving, provided the test area outside the strip met the requirement of residual voids content or sound absorption when it was measured.

6. Documentation of the test surface and of tests performed on it

6.1. Documentation of the test surface

The following data shall be given in a document describing the test surface:

6.1.1. The location of the test track.

6.1.2. Type of binder, binder hardness, type of aggregate, maximum theoretical density of the concrete ( $D_R$ ), thickness of the wearing course and grading curve determined from cores from the test track.

6.1.3. Method of compaction (e.g. type of roller, roller mass, number of passes).

6.1.4. Temperature of the mix, temperature of the ambient air and wind speed during laying of the surface.

6.1.5. Date when the surface was laid and name of the contractor.

6.1.6. All test results or at least the latest test result, including:

6.1.6.1. The residual voids content of each core;

6.1.6.2. The locations in the test area from where the cores for voids measurements have been taken;

- 6.1.6.3. The sound absorption coefficient of each core (if measured). Specify the results both for each core and each frequency range, as well as the overall average;
- 6.1.6.4. The locations in the test area from where the cores for absorption measurement have been taken;
- 6.1.6.5. Texture depth, including the number of tests and standard deviation;
- 6.1.6.6. The institution responsible for the tests according to paragraphs 6.1.6.1. and 6.1.6.2. above and the type of equipment used;
- 6.1.6.7. Date of the test(s) and date when the cores were taken from the test track.
- 6.2. Documentation of vehicle ~~noise~~ **sound** tests conducted on the surface

In the document describing the vehicle ~~noise~~ **sound** test(s) it should be stated whether all the requirements of this standard were fulfilled or not. Reference shall be given to a document according to paragraph 6.1. above describing the results which verify this.

\_\_\_\_\_ "

## II. Justification

### *Throughout the whole Regulation*

1. The term "noise" was replaced by "sound" or "sound emission" except for background noise in order to bring it in line with other Regulations (e.g. Nos. 41 and 51). Consequently, the term "noise made by" was replaced by "sound emitted by".
2. The letter "S" representing the rated engine speed was replaced by  $n_{\text{rated}}$  in order to prevent misunderstandings.
3. The symbol "%" was replaced by "per cent" in order to reflect the present practice.
4. Fractions like " $\frac{3}{4}$ " were replaced by percentages like "75 per cent".
5. Whenever the word "speed" is used without further specification, it was specified whether "engine speed" or "vehicle speed" is meant.

### *Paragraph 2.1.*

6. "As a technical unit" was replaced by "as a technical unit of a vehicle type, falling under the scope of this Regulation" in order to make the text more comprehensible.

### *Paragraph 2.2. "Vehicle type"*

7. Sub-paragraphs 2.2.3.1. and 2.2.3.2. were moved to new paragraphs 2.3. and 2.4., because the definitions for rated maximum net power and rated engine speed should be separated from the definition of a vehicle type.
8. A new sub-paragraph 2.2.4. "The electric motor in case of a hybrid electric vehicle" was added in order to cover also hybrid electric vehicles. The inclusion of hybrid electric vehicles is necessary, because L<sub>5</sub> category hybrid electric vehicles exist on the European market.
9. Sub-paragraph 2.2.4. was renumbered to 2.2.5. and the text was modified in order to make it more comprehensible. Sub-paragraph 2.2.5. was renumbered to 2.2.6.

### *Paragraph 2.3. (former 2.2.3.1.)*

10. The reference to the ISO standard was updated to the latest version. The symbol  $P_n$  was added for easier reference in the text and in equations.

### *Paragraph 2.4. (former 2.2.3.2.)*

11. The symbol  $n_{\text{rated}}$  was added for easier reference in the text and in equations.
12. The existing paragraphs 2.3. to 2.6. were renumbered to 2.5. to 2.8.

### *Paragraph 2.7. (former 2.5.)*

13. To improve Regulation No. 9, the added text was copied from Regulation No. 63.

### *Paragraph 2.8. (former 2.6.)*

14. "Kerb mass" was replaced by "reference mass" in order to reflect the present practice. The reference to the ISO standard was deleted, because it was not necessary. The symbol  $m_{\text{ref}}$  was added for easier reference in the text and in equations.
15. In order to consider also hybrid electric vehicles, indent (e) was added.

*Paragraph 2.9. "Test mass"*

16. "Test mass" was added to the definitions in order to make the text in Annex 3 more comprehensible.

*Paragraph 2.10. (former 2.7.)*

17. "Maximum vehicle speed" means the maximum vehicle design speed measured according to ISO 7116:2011 for L<sub>2</sub> category vehicles and according to ISO 7117:2010 for L<sub>4</sub> and L<sub>5</sub> category vehicles. The references to the ISO standards were updated to the latest versions and the existing text was modified in order to also cover L<sub>2</sub> category vehicles appropriately.

18. The symbol  $v_{\max}$  was added for easier reference in the text and in equations.

*Paragraph 6.2.1.1.*

19. The text "If the vehicle has user selectable software programs or modes which affect the sound emission of the vehicle, all these modes shall be in compliance with the requirements in this paragraph. Testing shall be based on the worst case scenario" was added in order to prevent loopholes in the sound emission requirements.

20. Furthermore, the requirements for hybrid electric vehicles were added according to EU Directive 134/2014/EU. This is necessary, because L<sub>5</sub> category hybrid electric vehicles exist on the European market.

In Informal document GRB-63-08 these requirements were placed in paragraph 3.1.2.1. of Annex 3, but they better fit this paragraph of the body text.

*Paragraph 6.2.1.3.*

21. The sound limit values were moved to a new Annex 4, to align with other Regulations (e.g. Nos. 63 and 41).

*Paragraph 6.3.*

22. The header was replaced by "additional requirements" and the more specific text was moved to the appropriate sub-paragraphs as headers. The added headers make the text more comprehensible.

23. In paragraph 6.3.1., the word "easily" was deleted in order to strengthen the requirement.

24. In paragraph 6.3.2., the words "or electronically" and "rider selectable" were added to cover not only manually adjustable multi-mode exhaust or silencing systems but also more advanced electronically adjustable systems.

*Paragraph 7.*

25. In sub-paragraph 7.1.2., "Technical Testing Service" was replaced by "Technical Service responsible for conducting the tests" for clarity.

*Paragraph 11. "Transitional provisions"*

26. Sub-paragraphs 11.7. and 11.8. were added in accordance with ECE/TRANS/WP.29/2015/59, which was already adopted by WP 29.

*Annex 1*

27. Item 5. was renamed to "combustion engine" and supplemented by sub-items 5.1. "Engine manufacturer" and 5.2. "Engine type". The original text under item 5 was put under 5.3. and items 6. to 9. were renumbered as 5.4. to 5.7.

28. A new item 6. "Electric motor (if applicable)" was added with two sub-items 6.1. "Make" and 6.2. "Type" dealing with information for the electric motor in case of a hybrid electric vehicle. This information is necessary to determine a vehicle type in case of a hybrid electric vehicle.

29. Items 10. to 12. dealing with information about the transmission were merged under a new item 7 "Transmission" and supplemented by 7.1. "Make" and 7.2. "Type (manual, automatic, CVT)". The former items 10. to 12. were renumbered as 7.3. to 7.5. Items 13. to 18. were renumbered as 8. to 15.

24. Item 15. (former 18) "Sound levels" was restructured to make it more comprehensible. The required information was put under sub-items 15.1 to 15.4.

25. A new item 16. "In use compliance reference data" and sub-items 16.1. to 16.3. were added to specify such data. The aim is to allow not only stationary in use compliance tests but also more effective in use compliance tests with the vehicle in motion similar to the 04 series of amendments to Regulation No. 41.

29. Former item 19. was deleted in accordance with ECE/TRANS/WP.29/2015/59.

30. The remaining items 20. to 29. were renumbered as 17. to 26.

*Annex 3*

31. The header was modified in order to be more specific.

*Annex 3, paragraph 2.1.*

32. The whole paragraph was restructured in order to make the text more comprehensible.

33. The requirements for test site, weather conditions and background sound level correction were included into this paragraph.

34. Sub-paragraph 2.1.1. was entitled "Test site" and the text was modified according to ECE/TRANS/WP.29/2015/59.

35. In the new sub-paragraph 2.1.2., the figure "Weather conditions and background noise correction" was deleted, because it was not in line with the table, which contained the correct values.

*Annex 3, paragraph 2.2.*

36. The whole paragraph was restructured in order to make the text more comprehensible. It was divided into sub-paragraphs 2.2.1. "General conditions", 2.2.2. "Test mass of the vehicle" and 2.2.3. "Tyre selection and condition". The new text for the test mass specifications was placed under sub-paragraph 2.2.2. Where necessary, more specific text was also added for better comprehension.

*Annex 3, paragraph 3.*

37. The whole paragraph was restructured in order to make the text more comprehensible.

38. Header 3.1.1. "Positions for the test" was replaced by "Test arrangement and microphone positions". Figure 1 was moved from the current position to this paragraph.

39. The new paragraph 3.1.2. was entitled "Acceleration test execution, approach vehicle speed and gear use". Sub-paragraph 3.1.2.1. is dedicated to the acceleration test execution while sub-paragraph 3.1.2.2. contains the requirements for the approach speed and the gear use.

40. The gear use specifications were modified in order to align the transmission specifications with the 04 series of amendments to Regulation No. 41. Where necessary, the text was supplemented accordingly.

41. The content of the existing paragraph 4. "Interpretation of results for vehicles in motion" was integrated in paragraph 3. as sub-paragraphs 3.1.3. and 3.1.4., because it was exclusively dedicated to the measurement results for paragraph 3.1. "Interpretation of results for vehicles in motion" was replaced by "Sound level determination", which is more comprehensible.

42. The determination of the final result for hybrid electric vehicles was added in paragraph 3.1.4.

43. The calculation and rounding procedure was brought in line with the corresponding text in the 04 series of amendments to Regulation No. 41, which is more straightforward and better reflects the present practice.

*Annex 3, paragraph 3.2.*

44. The text was modified in order to make it more specific and comprehensible, where necessary.

*Annex 3, paragraph 3.2.4.2.*

45. Figures 2 and 4 were moved from the current positions (in the appendix) to this paragraph, because they belong to it. Figure 4 was renamed to figure 3 in order to ensure the right order.

*Annex 3, paragraph 3.2.4.3.*

46. "S" was replaced by  $n_{\text{rated}}$  in order to prevent misunderstandings,  $\frac{1}{2}$  was replaced by 50 per cent and  $\frac{3}{4}$  was replaced by 75 per cent to follow the present practice. The phrase "engine speed at which the engine produces its maximum power" was replaced by "rated engine speed as defined in paragraph 2.4. of this Regulation".

*Annex 3, paragraph 4. (new)*

47. A new paragraph 4. was inserted specifying the necessary data to be reported in order to facilitate in motion testing of the vehicle in use.

48. With regard to in use compliance tests, it is well known from former research studies that stationary tests are not very effective, because there is not enough load on the engine and silencers can be constructed in such a way as to comply with stationary tests, but leading to excessive sound emissions for full load acceleration tests. It is therefore proposed

to provide the data which is necessary to perform in use compliance tests according to Annex 3, paragraph 3.1. This item is already implemented in the 04 series of amendments to Regulation No. 41.

*Annex 3, paragraph 5.1.3.2.*

49. The references to ISO standards were updated to their latest versions.

*Annex 3, paragraph 5.1.4.2.1.*

50. Figure 3 was moved from paragraph 5.3. to this paragraph, where it belongs to, and was renamed to figure 4 to keep the right order.

*Annex 3, paragraphs 5.1.4.2.5., 5.1.4.2.6. and 5.1.4.3.5.*

51. "S" was replaced by  $n_{\text{rated}}$  in order to prevent misunderstandings and "%" was replaced by "per cent" to follow the present practice. Where applicable, the wording "rated engine speed as defined in paragraph 2.4. of this Regulation" was introduced to adapt the requirements related to engine speed in those paragraphs.

52. "To within +3 per cent" was replaced by "with a tolerance of +3 per cent".

*Annex 3, paragraph 5.2.2.*

53. The text was modified in order to make tampering more difficult.

*Annex 3, Appendix*

54. The Appendix was deleted, because its figures were integrated in the corresponding paragraphs of Annex 3.

*Annex 4*

55. This Annex containing a table with the sound emission limit values was added in order to follow the present practice.

*Annex 4 (former), Annex 5 (new)*

56. Since a new Annex 4 was added, the existing Annex 4 was renamed to Annex 5. Footnote 1 was added according to ECE/TRANS/WP.29/2015/59.