



Economic and Social Council

Distr.: General
5 March 2020

English only

Economic Commission for Europe

Inland Transport Committee

World Forum for Harmonization of Vehicle Regulations

Working Party on Pollution and Energy

Eightieth session

Geneva, 14-17 January 2020

Report of the Working Party on Pollution and Energy (GRPE) on its eightieth session

Addendum 2

Adopted amendments to ECE/TRANS/WP.29/GRPE/2020/4

The text reproduced below was adopted on the basis of ECE/TRANS/WP.29/GRPE/2020/4 amended by GRPE-80-39 (see para. 19 of the report) proposing a new 01 series of amendments to a new UN Regulation No. [XXX] on WLTP.



01 series of amendments for UN Regulation No. [XXX]¹

Uniform provisions concerning the approval of light duty passenger and commercial vehicles with regards to criteria emissions, emissions of carbon dioxide and fuel consumption and/or the measurement of electric energy consumption and electric range (WLTP)

Contents

	<i>Page</i>
1. Scope	6
2. Abbreviations	6
3. Definitions.....	8
4. Application for approval	19
5. Approval.....	21
6. Specifications and tests	23
7. Modification and extension of the type approval	41
8. Conformity of production (COP)	42
9. Penalties for non-conformity of production	49
10. Production definitively discontinued.....	50
11. Special Provisions	50
12. Transitional Provisions.....	50
13. Names and addresses of Technical Services responsible for conducting approval tests, and of Type Approval Authorities	50
 Appendix	
1. Type 1 test CoP verification for specific vehicle types	51
2. Verification of conformity of production for Type 1 test - statistical method.....	55
3. Run-in test procedure to determine run-in factors.....	64
4. Conformity of production for Type 4 test	67
5. Devices for monitoring on board the vehicle the consumption of fuel and/or electric energy .	69
6. Requirements for vehicles that use a reagent for the exhaust after-treatment system	72
 Annexes	
Annexes Part A	
A1. Engine and vehicle characteristics and information concerning the conduct of tests.....	78
Appendix	
1. WLTP Test Report.....	98

2.	WLTP Road Load Test Report	119
3.	WLTP Test Sheet.....	127
4.	Evaporative Emissions Test Report	130
A2.	Communication	133
	
A3.	Arrangements of the approval mark	149
Annexes Part B		
B1.	Worldwide light-duty test cycles (WLTC).....	154
B2.	Gear selection and shift point determination for vehicles equipped with manual transmissions	213
B3.	Reference fuels.....	228
B4.	Road load and dynamometer setting	241
B5.	Test equipment and calibrations.....	288
B6.	Type 1 test procedures and test conditions	325
Appendix		
1.	Emissions test procedure for all vehicles equipped with periodically regenerating systems.....	349
2.	Test procedure for rechargeable electric energy storage system monitoring	354
3.	Calculation of gas energy ratio for gaseous fuels (LPG and NG/biomethane)	359
B6a.	Ambient Temperature Correction Test for the determination of CO ₂ emissions under representative regional temperature conditions	360
B7.	Calculations.....	366
B8.	Pure electric, hybrid electric and compressed hydrogen fuel cell hybrid vehicles	395
Appendix		
1.	REESS state of charge profile.....	464
2.	REESS energy change-based correction procedure	469
3.	Determination of REESS current and REESS voltage for NOVC-HEVs, OVC-HEVs, PEVs and NOVC-FCHVs	478
4.	Preconditioning, soaking and REESS charging conditions of PEVs and OVC-HEVs .	480
5.	Utility factors (UF) for OVC-HEVs	482
6.	Selection of driver-selectable modes	483
7.	Fuel consumption measurement of compressed hydrogen fuel cell hybrid vehicles	490
8.	Calculation of additional values required for checking the Conformity of Production of electric energy consumption of PEVs and OVC-HEVs	493
Annexes Part C		
C1.	[Reserved]	496
C2.	[Reserved]	496
C3.	Type 4 test - Evaporative emissions.....	497
C4.	Type 5 test – Durability.....	521
Appendix		
1.	Reserved.....	524

2.	Reserved.....	525
3.	Standard Road Cycle (SRC)	526
4.	Special requirements for Hybrid Vehicles	529
C5.	On-Board Diagnostics (OBD) for motor vehicles	530
	Appendix	
1.	Functional aspects of On-Board Diagnostic (OBD) systems	538

Introduction

The intention of this Regulation is to establish uniform provisions concerning the approval of motor vehicles with regard to the emissions of light-duty vehicles based on the new World harmonized Light vehicle Test Procedure (WLTP) included in UN GTR No. 15 and the updated Evaporative Emissions test procedure (Type 4 test) which has been developed in UN GTR No. 19. It will enable Contracting Parties (CPs) to issue and accept UNECE approvals based on these new type approval tests.

The WLTP Type 1 test replaces both the current Type 1 test in UN Regulation No. 83 and UN Regulation No. 101, whilst the updated Evaporative Emissions test procedure (Type 4 test) replaces that currently in UN Regulation No 83.

In addition, this new Regulation includes an update to the Type 5 test for verifying the durability of pollution control devices and updated On-Board Diagnostic (OBD) requirements. These updates are in order to reflect the changes from the previous NEDC based Type 1 test to the new WLTP Type 1 test.

The 00 series of this Regulation covers two sets of requirements – termed Level 1A and Level 1B. Level 1A is based on a four phase test cycle (Low, Medium, High and Extra-High), whilst Level 1B is based on a three phase test cycle (Low, Medium and High), with different type 1 limits applying to these different levels. The majority of the regulatory text is applicable to both Level 1A and Level 1B. Where the requirements are specific to either Level 1A or Level 1B the relevant sections are labelled accordingly. This series of amendments covers regional requirements and does not require mutual recognition by other Contracting Parties.

The 01 series of this Regulation includes a harmonised procedure which contains the most stringent procedures/limits which shall be subject to full mutual recognition. A type approval to the 01 series shall therefore be accepted by all CPs having adopted this UN Regulation.

1. Scope

This Regulation applies to the type approval of vehicles of categories M1 with a reference mass not exceeding 2,610 kg and vehicles of categories M2 and N1 with a reference mass not exceeding 2,610 kg and a technical permissible maximum laden mass not exceeding 3,500 kg with regard to the WLTP Type 1 test for emissions of gaseous compounds, particulate matter, particle number and to emissions of carbon dioxide and fuel consumption and/or the measurement of electric energy consumption and electric range and to the Type 4 test on evaporative emissions.

In addition, this Regulation lays down rules for verifying the durability of pollution control devices and On-Board Diagnostic (OBD) systems.

At the manufacturer's request, type approval granted under this Regulation may be extended from vehicles mentioned above to vehicles of categories M1 with a reference mass not exceeding 2,840 kg and vehicles of categories M2 and N1 with a reference mass not exceeding 2,840 kg and a technical permissible maximum laden mass not exceeding 3,500 kg and which meet the conditions laid down in this Regulation.

OVC-FCHVs are out of the scope of this Regulation.

2. Abbreviations

2.1. General abbreviations

AC	Alternating current
APF	Assigned permeability factor
BWC	Butane working capacity
CFD	Computational fluid dynamics
CFV	Critical flow venturi
CFO	Critical flow orifice
CLD	Chemiluminescent detector
CLA	Chemiluminescent analyser
CVS	Constant volume sampler
DC	Direct current
EAF	Sum of ethanol, acetaldehyde and formaldehyde
ECD	Electron capture detector
ET	Evaporation tube
Extra High ₂	Class 2 WLTC extra high speed phase
Extra High ₃	Class 3 WLTC extra high speed phase
FCHV	Fuel cell hybrid vehicle
FID	Flame ionization detector
FSD	Full scale deflection
GC	Gas chromatograph
GFV	Gas Fuelled Vehicle
HEPA	High efficiency particulate air (filter)

HFID	Heated flame ionization detector
High ₂	Class 2 WLTC high speed phase
High _{3a}	Class 3a WLTC high speed phase
High _{3b}	Class 3b WLTC high speed phase
ICE	Internal combustion engine
LoD	Limit of detection
LoQ	Limit of quantification
Low ₁	Class 1 WLTC low speed phase
Low ₂	Class 2 WLTC low speed phase
Low ₃	Class 3 WLTC low speed phase
Medium ₁	Class 1 WLTC medium speed phase
Medium ₂	Class 2 WLTC medium speed phase
Medium _{3a}	Class 3a WLTC medium speed phase
Medium _{3b}	Class 3b WLTC medium speed phase
LC	Liquid chromatography
LPG	Liquefied petroleum gas
NDIR	Non-dispersive infrared (analyser)
NDUV	Non-dispersive ultraviolet
NG/biomethane	Natural gas/biomethane
NMC	Non-methane cutter
NOVC-FCHV	Not off-vehicle charging fuel cell hybrid vehicle
NOVC	Not off-vehicle charging
NOVC-HEV	Not off-vehicle charging hybrid electric vehicle
OBD	On-board Diagnostic
OBFCM	On-board fuel and/or energy consumption monitoring
OVC-FCHV	Off-vehicle charging fuel cell hybrid vehicle
OVC-HEV	Off-vehicle charging hybrid electric vehicle
P _a	Particulate mass collected on the background filter
P _e	Particulate mass collected on the sample filter
PAO	Poly-alpha-olefin
PCF	Particle pre-classifier
PCRF	Particle concentration reduction factor
PDP	Positive displacement pump
PER	Pure electric range
Per cent FS	Per cent of full scale
PF	Permeability factor
PM	Particulate matter emissions
PN	Particle number emissions

PNC	Particle number counter
PND1	First particle number dilution device
PND2	Second particle number dilution device
PTS	Particle transfer system
PTT	Particle transfer tube
QCL-IR	Infrared quantum cascade laser
R _{CDA}	Charge-depleting actual range
RCB	REESS charge balance
REESS	Rechargeable electric energy storage system
RRC	Rolling resistance coefficient
SHED	Sealed housing evaporative determination
SSV	Subsonic venturi
USFM	Ultrasonic flow meter
VPR	Volatile particle remover
WLTC	Worldwide light-duty test cycle

2.2. Chemical symbols and abbreviations

C ₁	Carbon 1 equivalent hydrocarbon
CH ₄	Methane
C ₂ H ₆	Ethane
C ₂ H ₅ OH	Ethanol
C ₃ H ₈	Propane
CH ₃ CHO	Acetaldehyde
CO	Carbon monoxide
CO ₂	Carbon dioxide
DOP	Di-octylphthalate
H ₂ O	Water
HCHO	Formaldehyde
NH ₃	Ammonia
NMHC	Non-methane hydrocarbons
NO _x	Oxides of nitrogen
NO	Nitric oxide
NO ₂	Nitrogen dioxide
N ₂ O	Nitrous oxide
THC	Total hydrocarbons

3. Definitions

For the purposes of this Regulation the following definitions shall apply:

3.0.1. "Vehicle type with regard to emissions" means a group of vehicles which:

(a) do not differ with respect to the criteria constituting an "interpolation family" as defined in paragraph 6.3.2.;

(b) fall in a single "CO₂ interpolation range" within the meaning of paragraph 2.3.2. of Annex B6;

(c) do not differ with respect to any characteristics that have a non-negligible influence on tailpipe emissions, such as, but not limited to, the following:

— types and sequence of pollution control devices (e.g. three-way catalyst, oxidation catalyst, lean NO_x trap, SCR, lean NO_x catalyst, particulate trap or combinations thereof in a single unit);

— exhaust gas recirculation (with or without, internal/external, cooled/non-cooled, low/high/combined pressure).

3.0.2. "*Engine capacity*" means:

For reciprocating piston engines, the nominal engine swept volume.

For rotary piston engines (Wankel), twice the nominal swept volume of a combustion chamber per piston.

3.0.3. "*Engine displacement*" means:

For reciprocating piston engines, the nominal engine swept volume.

For rotary piston engines (Wankel), the nominal swept volume of a combustion chamber per piston.

3.0.4. "*Approval of a vehicle*" means the approval of a vehicle type with regard to the scope of this Regulation.

3.1. Test equipment

3.1.1. "*Accuracy*" means the difference between a measured value and a reference value, traceable to a national standard and describes the correctness of a result. See Figure 1.

3.1.2. "*Calibration*" means the process of setting a measurement system's response so that its output agrees with a range of reference signals.

3.1.3. "*Calibration gas*" means a gas mixture used to calibrate gas analysers.

3.1.4. "*Double dilution method*" means the process of separating a part of the diluted exhaust flow and mixing it with an appropriate amount of dilution air prior to the particulate sampling filter.

3.1.5. "*Full flow exhaust dilution system*" means the continuous dilution of the total vehicle exhaust with ambient air in a controlled manner using a Constant Volume Sampler (CVS).

3.1.6. "*Linearization*" means the application of a range of concentrations or materials to establish a mathematical relationship between concentration and system response.

3.1.7. "*Major maintenance*" means the adjustment, repair or replacement of a component or module that could affect the accuracy of a measurement.

3.1.8. "*Non-Methane Hydrocarbons*" (NMHC) are the Total Hydrocarbons (THC) minus the methane (CH₄) contribution.

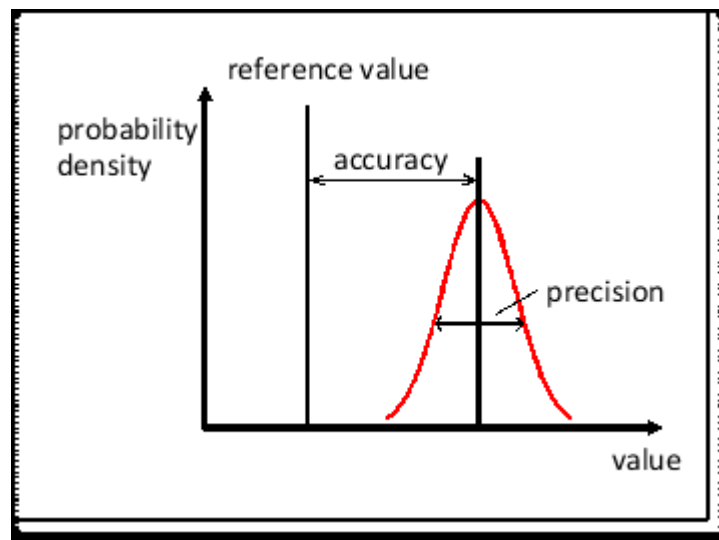
3.1.9. "*Precision*" means the degree to which repeated measurements under unchanged conditions show the same results (Figure 1) and, in this Regulation, always refers to one standard deviation.

3.1.10. "*Reference value*" means a value traceable to a national standard. See Figure 1.

3.1.11. "*Set point*" means the target value a control system aims to reach.

- 3.1.12. "Span" means to adjust an instrument so that it gives a proper response to a calibration standard that represents between 75 per cent and 100 per cent of the maximum value in the instrument range or expected range of use.
- 3.1.13. "Total hydrocarbons" (THC) means all volatile compounds measurable by a flame ionization detector (FID).
- 3.1.14. "Verification" means to evaluate whether or not a measurement system's outputs agrees with applied reference signals within one or more predetermined thresholds for acceptance.
- 3.1.15. "Zero gas" means a gas containing no analyte which is used to set a zero response on an analyser.
- 3.1.16. "Response time" means the difference in time between the change of the component to be measured at the reference point and a system response of 90 per cent of the final reading (t_{90}) with the sampling probe being defined as the reference point, whereby the change of the measured component is at least 60 per cent full scale (FS) and takes place in less than 0.1 second. The system response time consists of the delay time to the system and of the rise time of the system.
- 3.1.17. "Delay time" means the difference in time between the change of the component to be measured at the reference point and a system response of 10 per cent of the final reading (t_{10}) with the sampling probe being defined as the reference point. For gaseous components, this is the transport time of the measured component from the sampling probe to the detector.
- 3.1.18. "Rise time" means the difference in time between the 10 per cent and 90 per cent response of the final reading ($t_{90} - t_{10}$).

Figure 1

Definition of accuracy, precision and reference value

- 3.2. Road load and dynamometer setting
- 3.2.1. "Aerodynamic drag" means the force opposing a vehicle's forward motion through air.
- 3.2.2. "Aerodynamic stagnation point" means the point on the surface of a vehicle where wind velocity is equal to zero.
- 3.2.3. "Anemometer blockage" means the effect on the anemometer measurement due to the presence of the vehicle where the apparent air speed is different than the vehicle speed combined with wind speed relative to the ground.

- 3.2.4. "*Constrained analysis*" means the vehicle's frontal area and aerodynamic drag coefficient have been independently determined and those values shall be used in the equation of motion.
- 3.2.5. "*Mass in running order*" means the mass of the vehicle, with its fuel tank(s) filled to at least 90 per cent of its or their capacity/capacities, including the mass of the driver, fuel and liquids, fitted with the standard equipment in accordance with the manufacturer's specifications and, when they are fitted, the mass of the bodywork, the cabin, the coupling and the spare wheel(s) as well as the tools.
- 3.2.6. "*Mass of the driver*" means a mass rated at 75 kg located at the driver's seating reference point.
- 3.2.7. "*Maximum vehicle load*" means the technically permissible maximum laden mass minus the mass in running order, 25 kg and the mass of the optional equipment as defined in paragraph 3.2.8. of this Regulation.
- 3.2.8. "*Mass of the optional equipment*" means maximum mass of the combinations of optional equipment which may be fitted to the vehicle in addition to the standard equipment in accordance with the manufacturer's specifications.
- 3.2.9. "*Optional equipment*" means all the features not included in the standard equipment which are fitted to a vehicle under the responsibility of the manufacturer, and that can be ordered by the customer.
- 3.2.10. "*Reference atmospheric conditions (regarding road load measurements)*" means the atmospheric conditions to which these measurement results are corrected:
- (a) Atmospheric pressure: $p_0 = 100 \text{ kPa}$;
 - (b) Atmospheric temperature: $T_0 = 20 \text{ }^\circ\text{C}$;
 - (c) Dry air density: $\rho_0 = 1.189 \text{ kg/m}^3$;
 - (d) Wind speed: 0 m/s .
- 3.2.11. "*Reference speed*" means the vehicle speed at which road load is determined or chassis dynamometer load is verified.
- 3.2.12. "*Road load*" means the force resisting the forward motion of a vehicle as measured with the coastdown method or methods that are equivalent regarding the inclusion of frictional losses of the drivetrain.
- 3.2.13. "*Rolling resistance*" means the forces of the tyres opposing the motion of a vehicle.
- 3.2.14. "*Running resistance*" means the torque resisting the forward motion of a vehicle measured by torque meters installed at the driven wheels of a vehicle.
- 3.2.15. "*Simulated road load*" means the road load experienced by the vehicle on the chassis dynamometer which is intended to reproduce the road load measured on the road, and consists of the force applied by the chassis dynamometer and the forces resisting the vehicle while driving on the chassis dynamometer and is approximated by the three coefficients of a second order polynomial.
- 3.2.16. "*Simulated running resistance*" means the running resistance experienced by the vehicle on the chassis dynamometer which is intended to reproduce the running resistance measured on the road, and consists of the torque applied by the chassis dynamometer and the torque resisting the vehicle while driving on the chassis dynamometer and is approximated by the three coefficients of a second order polynomial.
- 3.2.17. "*Stationary anemometry*" means measurement of wind speed and direction with an anemometer at a location and height above road level alongside the test road where the most representative wind conditions will be experienced.

- 3.2.18. "*Standard equipment*" means the basic configuration of a vehicle which is equipped with all the features that are required under the regulatory acts of the Contracting Party including all features that are fitted without giving rise to any further specifications on configuration or equipment level.
- 3.2.19. "*Target road load*" means the road load to be reproduced on the chassis dynamometer.
- 3.2.20. "*Target running resistance*" means the running resistance to be reproduced.
- 3.2.21. "*Vehicle coastdown mode*" means a system of operation enabling an accurate and repeatable determination of road load and an accurate dynamometer setting.
- 3.2.22. "*Wind correction*" means correction of the effect of wind on road load based on input of the stationary or on-board anemometry.
- 3.2.23. "*Technically permissible maximum laden mass*" means the maximum mass allocated to a vehicle on the basis of its construction features and its design performances.
- 3.2.24. "*Actual mass of the vehicle*" means the mass in running order plus the mass of the fitted optional equipment to an individual vehicle.
- 3.2.25. "*Test mass of the vehicle*" means the sum of the actual mass of the vehicle, 25 kg and the mass representative of the vehicle load.
- 3.2.26. "*Mass representative of the vehicle load*" means x per cent of the maximum vehicle load where x is 15 per cent for category M vehicles and 28 per cent for category N vehicles.
- 3.2.27. "*Technically permissible maximum laden mass of the combination*" (MC) means the maximum mass allocated to the combination of a motor vehicle and one or more trailers on the basis of its construction features and its design performances or the maximum mass allocated to the combination of a tractor unit and a semi-trailer.
- 3.2.28. "*n/v ratio*" means the engine rotational speed divided by vehicle speed.
- 3.2.29. "*Single roller dynamometer*" means a dynamometer where each wheel on a vehicle's axle is in contact with one roller.
- 3.2.30. "*Twin-roller dynamometer*" means a dynamometer where each wheel on a vehicle's axle is in contact with two rollers.
- 3.2.31. "*Powered axle*" means an axle of a vehicle which is able to deliver propulsion energy and/or recuperate energy, independent of whether that is only temporarily or permanently possible and/or selectable by the driver.
- 3.2.32. "*2WD dynamometer*" means a dynamometer where only the wheels on one vehicle axle are in contact with the roller(s).
- 3.2.33. "*4WD dynamometer*" means a dynamometer where all wheels on both vehicle axles are in contact with the rollers.
- 3.2.34. "*Dynamometer in 2WD operation*" means a 2WD dynamometer, or a 4WD dynamometer which only simulates inertia and road load on the powered axle of the test vehicle and where the rotating wheels on the non-powered axle shall have no influence on the measurement results compared to a situation where the wheels on the non-powered axle are not rotating.
- 3.2.35. "*Dynamometer in 4WD operation*" means a 4WD dynamometer which simulates inertia and road load on both axles of the test vehicle.
- 3.2.36. "*Coasting*" means a functionality of either an automatic transmission or a clutch which decouples the engine from the drivetrain automatically when no propulsion or a slow reduction of speed is needed and during which the engine may be idling or switched off.

- 3.3. Pure electric, pure ICE, hybrid electric, fuel cell and alternatively-fuelled vehicles
- 3.3.1. "*All-Electric Range*" (AER) means the total distance travelled by an OVC-HEV from the beginning of the charge-depleting test to the point in time during the test when the combustion engine starts to consume fuel.
- 3.3.2. "*Pure Electric Range*" (PER) means the total distance travelled by a PEV from the beginning of the charge-depleting test until the break-off criterion is reached.
- 3.3.3. "*Charge-Depleting Actual Range*" (R_{CDA}) means the distance travelled in a series of WLTCs in charge-depleting operating condition until the Rechargeable Electric Energy Storage System (REESS) is depleted.
- 3.3.4. "*Charge-Depleting Cycle Range*" (R_{CDC}) means the distance from the beginning of the charge-depleting test to the end of the last cycle prior to the cycle or cycles satisfying the break-off criterion, including the transition cycle where the vehicle may have operated in both depleting and sustaining conditions.
- 3.3.5. "*Charge-depleting operating condition*" means an operating condition in which the energy stored in the REESS may fluctuate but decreases on average while the vehicle is driven until transition to charge-sustaining operation.
- 3.3.6. "*Charge-sustaining operating condition*" means an operating condition in which the energy stored in the REESS may fluctuate but, on average, is maintained at a neutral charging balance level while the vehicle is driven.
- 3.3.7. "*Utility Factors*" are ratios based on driving statistics depending on the range achieved in charge-depleting condition and are used to weigh the charge-depleting and charge-sustaining exhaust emission compounds, CO₂ emissions and fuel consumption for OVC-HEVs.
- 3.3.8. "*Electric machine*" (EM) means an energy converter transforming between electrical and mechanical energy.
- 3.3.9. "*Energy converter*" means a system where the form of energy output is different from the form of energy input.
- 3.3.9.1. "*Propulsion energy converter*" means an energy converter of the powertrain which is not a peripheral device whose output energy is used directly or indirectly for the purpose of vehicle propulsion.
- 3.3.9.2. "*Category of propulsion energy converter*" means (i) an internal combustion engine, or (ii) an electric machine, or (iii) a fuel cell.
- 3.3.10. "*Energy storage system*" means a system which stores energy and releases it in the same form as was input.
- 3.3.10.1. "*Propulsion energy storage system*" means an energy storage system of the powertrain which is not a peripheral device and whose output energy is used directly or indirectly for the purpose of vehicle propulsion.
- 3.3.10.2. "*Category of propulsion energy storage system*" means (i) a fuel storage system, or (ii) a rechargeable electric energy storage system, or (iii) a rechargeable mechanical energy storage system.
- 3.3.10.3. "*Form of energy*" means (i) electrical energy, or (ii) mechanical energy, or (iii) chemical energy (including fuels).
- 3.3.10.4. "*Fuel storage system*" means a propulsion energy storage system that stores chemical energy as liquid or gaseous fuel.
- 3.3.11. "*Equivalent all-electric range*" (EAER) means that portion of the total charge-depleting actual range (R_{CDA}) attributable to the use of electricity from the REESS over the charge-depleting range test.

- 3.3.12. "*Hybrid electric vehicle*" (HEV) means a hybrid vehicle where one of the propulsion energy converters is an electric machine.
- 3.3.13. "*Hybrid vehicle*" (HV) means a vehicle equipped with a powertrain containing at least two different categories of propulsion energy converters and at least two different categories of propulsion energy storage systems.
- 3.3.14. "*Net energy change*" means the ratio of the REESS energy change divided by the cycle energy demand of the test vehicle.
- 3.3.15. "*Not off-vehicle charging hybrid electric vehicle*" (NOVC-HEV) means a hybrid electric vehicle that cannot be charged from an external source.
- 3.3.16. "*Off-vehicle charging hybrid electric vehicle*" (OVC-HEV) means a hybrid electric vehicle that can be charged from an external source.
- 3.3.17. "*Pure electric vehicle*" (PEV) means a vehicle equipped with a powertrain containing exclusively electric machines as propulsion energy converters and exclusively rechargeable electric energy storage systems as propulsion energy storage systems.
- 3.3.18. "*Fuel cell*" means an energy converter transforming chemical energy (input) into electrical energy (output) or vice versa.
- 3.3.19. "*Fuel cell vehicle*" (FCV) means a vehicle equipped with a powertrain containing exclusively fuel cell(s) and electric machine(s) as propulsion energy converter(s).
- 3.3.20. "*Fuel cell hybrid vehicle*" (FCHV) means a fuel cell vehicle equipped with a powertrain containing at least one fuel storage system and at least one rechargeable electric energy storage system as propulsion energy storage systems.
- 3.3.20.1. "*Not off-vehicle charging fuel cell hybrid electric vehicle*" (NOVC-FCHV) means a fuel cell hybrid electric vehicle that cannot be charged from an external source.
- 3.3.20.2. "*Off-vehicle charging fuel cell hybrid electric vehicle*" (OVC-FCHV) means a fuel cell hybrid electric vehicle that can be charged from an external source.
- 3.3.21. "*Bi-fuel vehicle*" means a vehicle with two separate fuel storage systems that is designed to run primarily on only one fuel at a time; however, the simultaneous use of both fuels is permitted in limited amount and duration.
- 3.3.22. "*Bi-fuel gas vehicle*" means a bi-fuel vehicle where the two fuels are petrol (petrol mode) and either LPG, NG/biomethane, or hydrogen.
- 3.3.23. "*Pure ICE vehicle*" means a vehicle where all of the propulsion energy converters are internal combustion engines.
- 3.3.24. "*On-board charger*" means the electric power converter between the traction REESS and the vehicle's recharging socket.
- 3.3.25. "*Flex fuel vehicle*" means a vehicle with one fuel storage system that can run on different mixtures of two or more fuels.
- 3.3.26. "*Flex fuel ethanol vehicle*" means a flex fuel vehicle that can run on petrol or a mixture of petrol and ethanol up to an 85 per cent ethanol blend (E85).
- 3.3.27. "*Mono-fuel vehicle*" means a vehicle that is designed to run primarily on one type of fuel.
- 3.3.28. "*Mono-fuel gas vehicle*" means a mono-fuel vehicle that is designed primarily for permanent running on LPG or NG/biomethane or hydrogen, but may also have a petrol system for emergency purposes or starting only, where the nominal capacity of the petrol tank does not exceed 15 litres.
- 3.4. Powertrain

- 3.4.1. "Powertrain" means the total combination in a vehicle of propulsion energy storage system(s), propulsion energy converter(s) and the drivetrain(s) providing the mechanical energy at the wheels for the purpose of vehicle propulsion, plus peripheral devices.
- 3.4.2. "Auxiliary devices" means energy consuming, converting, storing or supplying non-peripheral devices or systems which are installed in the vehicle for purposes other than the propulsion of the vehicle and are therefore not considered to be part of the powertrain.
- 3.4.3. "Peripheral devices" means any energy consuming, converting, storing or supplying devices, where the energy is not directly or indirectly used for the purpose of vehicle propulsion but which are essential to the operation of the powertrain and are therefore considered to be part of the powertrain.
- 3.4.4. "Drivetrain" means the connected elements of the powertrain for transmission of the mechanical energy between the propulsion energy converter(s) and the wheels.
- 3.4.5. "Manual transmission" means a transmission where gears can only be shifted by action of the driver.
- 3.5. General
- 3.5.1. "Criteria emissions" means those emission compounds for which limits are set in regional legislation.
- 3.5.2. Reserved
- 3.5.3. Reserved
- 3.5.4. Reserved
- 3.5.5. Reserved
- 3.5.6. "Cycle energy demand" means the calculated positive energy required by the vehicle to drive the prescribed cycle.
- 3.5.7. "Defeat device" means any element of design which senses temperature, vehicle speed, engine speed (RPM), transmission gear, manifold vacuum or any other parameter for the purpose of activating, modulating, delaying or deactivating the operation of any part of the emission control system, that reduces the effectiveness of the emission control system under conditions which may reasonably be expected to be encountered in normal vehicle operation and use.
- 3.5.8. "Driver-selectable mode" means a distinct driver-selectable condition which could affect emissions, or fuel and/or energy consumption.
- 3.5.9. "Predominant mode" for the purpose of this Regulation means a single driver-selectable mode that is always selected when the vehicle is switched on, regardless of the driver-selectable mode in operation when the vehicle was previously shut down, and which cannot be redefined to another mode. After the vehicle is switched on, the predominant mode can only be switched to another driver-selectable mode by an intentional action of the driver.
- 3.5.10. "Reference conditions (with regards to calculating mass emissions)" means the conditions upon which gas densities are based, namely 101.325 kPa and 273.15 K (0 °C).
- 3.5.11. "Exhaust emissions" means the emission of gaseous, solid and liquid compounds from the tailpipe.
- 3.5.12. 'Configurable start mode' for the purpose of this Regulation means a driver-selectable mode that can be set by the driver as a mode which is automatically selected when the vehicle is switched on. After the vehicle is switched on, the configurable start mode can only be switched to another mode by an intentional action of the driver.

- 3.6. PM/PN
- The term "particle" is conventionally used for the matter being characterised (measured) in the airborne phase (suspended matter), and the term "particulate" for the deposited matter.
- 3.6.1. "*Particle number emissions*" (PN) means the total number of solid particles emitted from the vehicle exhaust quantified according to the dilution, sampling and measurement methods as specified in this Regulation.
- 3.6.2. "*Particulate matter emissions*" (PM) means the mass of any particulate material from the vehicle exhaust quantified according to the dilution, sampling and measurement methods as specified in this Regulation.
- 3.7. WLTC
- 3.7.1. "*Rated engine power*" (P_{rated}) means maximum net power of the engine or motor in kW as per the requirements of UN Regulation No. 85.
- 3.7.2. "*Maximum speed*" (v_{max}) means the maximum speed of a vehicle as declared by the manufacturer. In the absence of a declaration, the maximum speed shall be determined according to UN Regulation No. 68.
- 3.8. Procedure
- 3.8.1. "*Periodically regenerating system*" means an exhaust emissions control device (e.g. catalytic converter, particulate trap) that requires a periodical regeneration.
- 3.9. Evaporative emissions
- 3.9.1. "*Fuel tank system*" means the devices which allow storing the fuel, comprising the fuel tank, the fuel filler, the filler cap and the fuel pump when it is fitted in or on the fuel tank.
- 3.9.2. "*Fuel system*" means the components which store or transport fuel on board the vehicle and comprise the fuel tank system, all fuel and vapour lines, any non-tank mounted fuel pumps and the activated carbon canister.
- 3.9.3. "*Butane working capacity*" (BWC) means the mass of butane which a carbon canister can adsorb.
- 3.9.4. "*BWC300*" means the butane working capacity after 300 cycles of fuel ageing cycles experienced.
- 3.9.5. "*Permeability Factor*" (PF) means the factor determined from hydrocarbon losses over a period of time and used to determine the final evaporative emissions.
- 3.9.6. "*Monolayer non-metal tank*" means a fuel tank constructed with a single layer of non-metal material including fluorinated/sulfonated materials.
- 3.9.7. "*Multilayer tank*" means a fuel tank constructed with at least two different layered materials, one of which is a hydrocarbon barrier material.
- 3.9.8. "*Sealed fuel tank system*" means a fuel tank system where the fuel vapours do not vent during parking over the 24-hour diurnal cycle defined in paragraph 6.5.9. of Annex C3 when performed with the applicable reference fuel defined in paragraph 7 of Annex B3.
- 3.9.9. "*Evaporative emissions*" means in the context of this Regulation the hydrocarbon vapours lost from the fuel system of a motor vehicle during parking and immediately before refuelling of a sealed fuel tank.
- 3.9.10. "*Depressurisation puff loss*" means hydrocarbons venting from a sealed fuel tank system pressure relief exclusively through the carbon canister allowed by the system.

- 3.9.11. "*Depressurisation puff loss overflow*" are the depressurisation puff loss hydrocarbons that pass through the carbon canister during depressurisation.
- 3.9.12. "*Fuel tank relief pressure*" is the minimum pressure value at which the sealed fuel tank system starts venting in response only to pressure inside the tank.
- 3.9.13. "*2 gram breakthrough*" shall be considered accomplished when the cumulative quantity of hydrocarbons emitted from the activated carbon canister equals 2 grams.
- 3.10. On-Board Diagnostics (OBD)
- 3.10.1. "*On-Board Diagnostic (OBD) system*" means in context of this regulation, a system on-board the vehicle which has the capability of detecting malfunctions of the monitored emission control systems, identifying the likely area of a malfunction by means of fault codes stored in computer memory, and illumination of the Malfunction Indicator (MI) to notify the operator of the vehicle.
- 3.10.2. "*OBD family*" means a manufacturer's grouping of vehicles which, through their design, are expected to have similar exhaust emission and OBD system characteristics. Each vehicle of this family shall have complied with the requirements of this Regulation as defined in paragraph 6.8.1.
- 3.10.3. "*Emission control system*" means in the context of OBD the electronic engine management controller and any emission-related component in the exhaust or evaporative system which supplies an input to or receives an output from this controller.
- 3.10.4. "*Malfunction indicator (MI)*" means a visible or audible indicator that clearly informs the driver of the vehicle in the event of a malfunction of any emission-related component connected to the OBD system, or the OBD system itself.
- 3.10.5. "*Malfunction*" means the failure of an emission-related component or system that would result in emissions exceeding the OBD thresholds in paragraph 6.8.2. of this Regulation or if the OBD system is unable to fulfil the basic monitoring requirements of Annex C5.
- 3.10.6. "*Secondary air*" refers to air introduced into the exhaust system by means of a pump or aspirator valve or other means that is intended to aid in the oxidation of HC and CO contained in the exhaust gas stream.
- 3.10.7. "*Engine misfire*" means lack of combustion in the cylinder of a positive ignition engine due to absence of spark, poor fuel metering, poor compression or any other cause. In terms of OBD monitoring it is that percentage of misfires out of a total number of firing events (as declared by the manufacturer) that would result in emissions exceeding the OBD thresholds given in paragraph 6.8.2. of this Regulation or that percentage that could lead to an exhaust catalyst, or catalysts, overheating causing irreversible damage.
- 3.10.8. A "*driving cycle*" consists of key-on, a driving mode where a malfunction would be detected if present, and key-off.
- 3.10.9. A "*warm-up cycle*" means sufficient vehicle operation such that the coolant temperature has risen by a least 22 K from engine starting and reaches a minimum temperature of 343 K (70 °C).
- 3.10.10. A "*Fuel trim*" refers to feedback adjustments to the base fuel schedule. Short-term fuel trim refers to dynamic or instantaneous adjustments. Long-term fuel trim refers to much more gradual adjustments to the fuel calibration schedule than short-term trim adjustments. These long-term adjustments compensate for vehicle differences and gradual changes that occur over time.
- 3.10.11. A "*Calculated load value*" refers to an indication of the current airflow divided by peak airflow, where peak airflow is corrected for altitude, if available. This

definition provides a dimensionless number that is not engine specific and provides the service technician with an indication of the proportion of engine capacity that is being used (with wide open throttle as 100 per cent);

$$CLV = \frac{\text{Current airflow}}{\text{Peak airflow (at sea level)}} \cdot \frac{\text{Atmospheric pressure(at sea level)}}{\text{Barometric pressure}}$$

- 3.10.12. *"Permanent emission default mode"* refers to a case where the engine management controller permanently switches to a setting that does not require an input from a failed component or system where such a failed component or system would result in an increase in emissions from the vehicle to a level above the OBD thresholds given in paragraph 6.8.2. of this Regulation.
- 3.10.12.1. Permanent in this context means that the default mode is not recoverable, i.e. the diagnostic or control strategy that caused the emission default mode cannot run in the next driving cycle and cannot confirm that the conditions that caused the emission default mode is not present anymore. All other emission default modes are considered not to be permanent.
- 3.10.13. *"Power take-off unit"* means an engine-driven output provision for the purposes of powering auxiliary, vehicle mounted, equipment.
- 3.10.14. *"Access"* means the availability of all emission-related OBD data including all fault codes required for the inspection, diagnosis, servicing or repair of emissions-related parts of the vehicle, via the serial interface for the standard diagnostic connection (pursuant to paragraph 6.5.3.5. of Appendix 1 to Annex C5).
- 3.10.15. *"Unrestricted"* means:
- 3.10.15.1. Access not dependent on an access code obtainable only from the manufacturer, or a similar device; or
- 3.10.15.2. Access allowing evaluation of the data produced without the need for any unique decoding information, unless that information itself is standardised.
- 3.10.16. *"Standardised"* means that all data stream information, including all fault codes used, shall be produced only in accordance with industry standards which, by virtue of the fact that their format and their permitted options are clearly defined, provide for a maximum level of harmonisation in the motor vehicle industry, and whose use is expressly permitted in this Regulation.
- 3.10.17. *"Repair information"* means all information required for diagnosis, servicing, inspection, periodic monitoring or repair of the vehicle and which the manufacturers provide for their authorised dealers/repair shops. Where necessary, such information shall include service handbooks, technical manuals, diagnosis information (e.g. minimum and maximum theoretical values for measurements), wiring diagrams, the applicable software calibration identification number, instructions for individual and special cases, information provided concerning tools and equipment, data record information and two-directional monitoring and test data. The manufacturer shall not be obliged to make available that information which is covered by intellectual property rights or constitutes specific know-how of manufacturers and/or OEM suppliers; in this case the necessary technical information shall not be improperly withheld.
- 3.10.18. *"Deficiency"* means, in respect of vehicle OBD systems, that components or systems that are monitored contain temporary or permanent operating characteristics that impair the otherwise efficient OBD monitoring of those components or systems or do not meet all of the other detailed requirements for OBD.
- 3.10.19. *"Limp-home routines"* means any default mode other than emission default mode.

- 3.10.20. "Pending fault code" is a diagnostic trouble code stored upon the initial detection of a malfunction prior to illumination of the malfunction indicator.
- 3.10.21. "Readiness" means a status indicating whether a monitor or a group of monitors have run since the last erasing by an external request or command (for example through an OBD scan-tool).
- 3.11. Ambient Temperature Correction Test (Annex B6a)
- 3.11.1 "Active heat storage device" means a technology that stores heat within any device of a vehicle and releases the heat to a power train component over a defined time period at engine start. It is characterised by the stored enthalpy in the system and the time for heat release to the power train components.
- 3.11.2. "Insulation materials" means any material in the engine compartment attached to the engine and/or the chassis with a thermal insulation effect and characterised by a maximum heat conductivity of 0.1 W/(mK).

4. Application for approval

- 4.1. The application for approval of a vehicle type with regard to the requirements of this Regulation shall be submitted by the vehicle manufacturer or by their authorized representative to the Type Approval Authority.
- 4.1.1. The application referred to in paragraph 4.1. shall be drawn up in accordance with the model of the information document set out in Annex A1 to this Regulation.
- 4.1.2. In addition, the manufacturer shall submit the following information:
- (a) In the case of vehicles equipped with positive ignition engines, a declaration by the manufacturer of the minimum percentage of misfires out of a total number of firing events that would either result in emissions exceeding the OBD threshold limits given in paragraph 6.8.2., if that percentage of misfire had been present from the start of a Type 1 test as described in Annexes Part B to this Regulation, or that could lead to an exhaust catalyst, or catalysts, overheating prior to causing irreversible damage;
 - (b) Detailed written information fully describing the functional operation characteristics of the OBD system, including a listing of all relevant parts of the emission control system of the vehicle that are monitored by the OBD system;
 - (c) A description of the malfunction indicator used by the OBD system to signal the presence of a fault to a driver of the vehicle;
 - (d) A declaration by the manufacturer that the OBD system complies with the provisions of paragraph 7. of Appendix 1 to Annex C5 to this Regulation relating to in-use performance under all reasonably foreseeable driving conditions;
 - (e) A plan describing the detailed technical criteria and justification for incrementing the numerator and denominator of each monitor that shall fulfil the requirements of paragraphs 7.2. and 7.3. of Appendix 1 to Annex C5 to this Regulation, as well as for disabling numerators, denominators and the general denominator under the conditions outlined in paragraph 7.7. of Appendix 1 to Annex C5 to this Regulation;
 - (f) A description of the provisions taken to prevent tampering with and modification of the emission control computer;

- (g) If applicable, the particulars of the OBD family as referred to in paragraph 6.8.1.;
 - (h) Where appropriate, copies of other type approvals with the relevant data to enable extension of approvals and establishment of deterioration factors.
- 4.1.3. For the tests described in paragraph 3. of Annex C5 to this Regulation, a vehicle representative of the vehicle type or vehicle family fitted with the OBD system to be approved shall be submitted to the Technical Service responsible for the type approval test. If the Technical Service determines that the submitted vehicle does not fully represent the OBD family described in paragraph 6.8.1., an alternative and, if necessary, an additional vehicle shall be submitted for test in accordance with paragraph 3. of Annex C5 to this Regulation.
- 4.2. A model of the information document relating to exhaust emissions, emissions of carbon dioxide and fuel consumption and/or the measurement of electric energy consumption and electric range, evaporative emissions, durability and OBD, is given in Annex A1 to this Regulation. The information mentioned under item 3.2.12.2.7.6. of Annex A1 to this Regulation is to be included in Appendix 1 "OBD - Related information" to the type approval communication given in Annex A2 to this Regulation.
- 4.2.1. Where appropriate, copies of other type approvals with the relevant data to enable extensions of approvals and establishment of deterioration factors shall be submitted.
- 4.3. For the tests specified in Table A in paragraph 6. of this Regulation a vehicle representative of the vehicle type to be approved shall be submitted to the Technical Service responsible for the approval tests.
- 4.3.1. For the purposes of paragraph 4.1.2.(e), the Type Approval Authority that grants the approval shall make the information referred to in that point available to the Type Approval Authorities upon request.
- 4.3.2. For the purposes of subparagraphs 4.1.2. (d) and (e), Type Approval Authorities shall not approve a vehicle if the information submitted by the manufacturer is inappropriate for fulfilling the requirements of paragraph 7. of Appendix 1 to Annex C5 to this Regulation. Paragraphs 7.2., 7.3. and 7.7. of Appendix 1 to Annex C5 to this Regulation shall apply under all reasonably foreseeable driving conditions. For the assessment of the implementation of the requirements set out in the paragraphs 7.2. and 7.3. of Appendix 1 to Annex C5, the Type Approval Authority shall take into account the state of technology.
- 4.3.3. For the purposes of paragraph 4.1.2. (f), the provisions taken to prevent tampering with and modification of the emission control computer shall include the facility for updating using a manufacturer-approved programme or calibration.
- 4.3.4. The application for type approval of flex-fuel, mono fuel, and bi-fuel vehicles shall comply with the additional requirements laid down in paragraphs 5.8. and 5.9. of this Regulation.
- 4.3.5. Changes to the make of a system, component or separate technical unit that occur after a type approval shall not automatically invalidate a type approval, unless its original characteristics or technical parameters are changed in such a way that the functionality of the engine or pollution control system is affected.
- 4.4. The Type Approval Authority shall verify the existence of satisfactory provisions to ensure an effective check of conformity of production before approval of the vehicle type is granted.

5. Approval

- 5.1. If the vehicle type submitted for approval meets all the relevant requirements of paragraph 6. of this Regulation, approval of that vehicle type shall be granted.
- 5.2. An approval number shall be assigned to each type approved.
- 5.2.1. The type approval number shall consist of four sections. Each section shall be separated by the '*' character.
- Section 1: The capital letter 'E' followed by the distinguishing number of the Contracting Party which has granted the type approval².
- Section 2: The number [of this UN Regulation,] followed by the letter 'R', successively followed by:
- (a) Two digits (with leading zeros as applicable) indicating the series of amendments incorporating the technical provisions of the UN Regulation applied to the approval (00 for the UN Regulation in its original form);
 - (b) A slash (/) and two digits (with leading zeros as applicable) indicating the number of supplement to the series of amendments applied to the approval (00 for the series of amendments in its original form);
 - (c) A slash (/) and one or two character(s) indicating the implementing stage (e.g. 1A, 1B, 02).
- Section 3: A four-digit sequential number (with leading zeros as applicable). The sequence shall start from 0001.
- Section 4: A two-digit sequential number (with leading zeros if applicable) to denote the extension. The sequence shall start from 00.
- All digits shall be Arabic digits.
- 5.2.2. Example of an Approval Number to this Regulation:
E11*[XXX]R01/00/02*0123*01
- The first extension of the Approval numbered 0123, issued by the United Kingdom to Series of Amendments 01 which is a Level 2 Approval.
- 5.2.3. The same Contracting Party shall not assign the same number to another vehicle type.
- 5.3. Notice of approval or of extension or refusal of approval of a vehicle type pursuant to this Regulation shall be communicated to the Contracting Parties to the 1958 Agreement which apply this Regulation by means of a form conforming to the model in Annex A2 to this Regulation.
- 5.3.1. In the event of amendment to the present text, for example, if new limit values are prescribed, the Contracting Parties to the 1958 Agreement shall be informed which vehicle types already approved comply with the new provisions.
- 5.4. There shall be affixed, conspicuously and in a readily accessible place specified on the approval form, to every vehicle conforming to a vehicle type approved under this Regulation, an international approval mark consisting of:
- 5.4.1. A circle surrounding the letter "E" followed by the distinguishing number of the Contracting Party that has granted approval.

- 5.4.2. The number of this Regulation, followed by the letter "R", a dash and the approval number to the right of the circle described in paragraph 5.4.1.
- 5.4.3. The approval mark shall contain an additional code after the type approval number, the purpose of which is to distinguish the level (Level 1A, 1B or 2) for which the approval has been granted. This code should be chosen according to the Table A3/1 of Annex A3 to this Regulation.
- 5.5. If the vehicle conforms to a vehicle type approved, under one or more other Regulations annexed to the 1958 Agreement, in the country which has granted approval under this Regulation, the symbol prescribed in paragraph 5.4.1. need not be repeated; in such a case, the Regulation, approval numbers and the additional symbols of all the Regulations under which approval has been granted in the country which has granted approval under this Regulation shall be placed in vertical columns to the right of the symbol prescribed in paragraph 5.4.1. (see Annex A3).
- 5.6. The approval mark shall be clearly legible and be indelible.
- 5.7. The approval mark shall be placed close to or on the vehicle data plate.
- 5.7.1. Annex A3 to this Regulation gives examples of arrangements of the approval mark.
- 5.8. Additional requirements for approval of flex fuel vehicles
- 5.8.1. For the type approval of a flex fuel ethanol vehicle, the vehicle manufacturer shall describe the capability of the vehicle to adapt to any mixture of petrol and ethanol fuel (up to an 85 per cent ethanol blend).
- 5.9. Additional requirements for mono fuel gas vehicles, and bi-fuel gas vehicles.
- 5.9.1. For LPG or NG, the fuel to be used shall be specified in the information document set out in Annex A1 to this Regulation.
- 5.10. Requirements for approval regarding the OBD system
- 5.10.1. The manufacturer shall ensure that all vehicles are equipped with an OBD system.
- 5.10.2. The OBD system shall be designed, constructed and installed on a vehicle so as to enable it to identify types of deterioration or malfunction over the entire life of the vehicle.
- 5.10.3. The OBD system shall comply with the requirements of this Regulation during conditions of normal use.
- 5.10.4. When tested with a defective component in accordance with Appendix 1 to Annex C5 to this Regulation, the OBD system malfunction indicator shall be activated. The OBD system malfunction indicator may also activate during this test at levels of emissions below the OBD threshold limits specified in paragraph 6.8. to this Regulation.
- 5.10.5. The manufacturer shall ensure that the OBD system complies with the requirements for in-use performance set out in paragraph 7. of Appendix 1 to Annex C5 to this Regulation under all reasonably foreseeable driving conditions.
- 5.10.6. In-use performance related data to be stored and reported by a vehicle's OBD system according to the provisions of paragraph 7.6. of Appendix 1 to Annex C5 to this Regulation shall be made readily available by the manufacturer to national authorities and independent operators without any encryption.
- 5.11. Requirements for type-approval regarding devices for monitoring the consumption of fuel and/or electric energy

- 5.11.1. The manufacturer shall ensure that the following vehicles of categories M1 and N1 are equipped with a device for determining, storing and making available data on the quantity of fuel and/or electric energy used for the operation of the vehicle:
- (a) pure ICE and Not-Off-Vehicle Charging Hybrid Electric vehicles (NOVC-HEVs) powered exclusively by mineral diesel, biodiesel, petrol, ethanol or any combination of these fuels;
 - (b) Off-Vehicle Charging Hybrid Electric Vehicles (OVC-HEVs) powered by electricity and any of the fuels mentioned in point (a).
- 5.11.2. The device for monitoring the consumption of fuel and/or electric energy shall comply with the requirements laid down in Appendix 5.

6. Specifications and tests

6.1. General

- 6.1.1. The vehicle and its components liable to affect CO₂ and fuel consumption or electric energy consumption and the emissions of gaseous compounds, including evaporative emissions, particulate matter, particle number (if PN measurement is required) shall be so designed, constructed and assembled as to enable the vehicle in normal use and under normal conditions of use such as humidity, rain, snow, heat, cold, sand, dirt, vibrations, wear, etc. to comply with the provisions of this Regulation during its useful life. This shall include the security of all hoses, joints and connections used within the emission control systems and the evaporative emission control systems.

For exhaust emissions, CO₂ and fuel consumption or electric energy consumption these provisions are deemed to be met if the provisions of paragraph 6.3. of this Regulation and paragraph 8.2. of this Regulation are complied with.

For evaporative emissions, these conditions are deemed to be met if the provisions of paragraph 6.6. of this Regulation and paragraph 8.3. of this Regulation are complied with.

- 6.1.2. The test vehicle shall be representative in terms of its emissions-related components and functionality of the intended production series to be covered by the approval. The manufacturer and the responsible authority shall agree which vehicle test model is representative.
- 6.1.3. With respect to evaporative emissions, for vehicles with a sealed fuel tank system, this shall also include having a system which, just before refuelling, releases the tank pressure exclusively through a carbon canister which has the sole function of storing fuel vapour. This ventilation route shall also be the only one used when the tank pressure exceeds its safe working pressure.
- 6.1.4. Vehicle testing condition
- 6.1.4.1. The types and amounts of lubricants and coolant for emissions testing shall be as specified for normal vehicle operation by the manufacturer.
 - 6.1.4.2. The type of fuel for emissions testing shall be as specified in Annex B3 to this Regulation.
 - 6.1.4.3. All emissions controlling systems, including evaporative emissions controlling systems shall be in working order.
 - 6.1.4.4. The engine shall be designed to avoid crankcase emissions.
 - 6.1.4.5. The tyres used for emissions testing shall be as defined in paragraph 2.4.5. of Annex B6 to this Regulation.

- 6.1.5. Fuel tank inlet orifices
 - 6.1.5.1. Subject to paragraph 6.1.5.2. of this Regulation, the inlet orifice of the petrol or ethanol tank shall be so designed as to prevent the tank from being filled from a fuel pump delivery nozzle which has an external diameter of 23.6 mm or greater.
 - 6.1.5.2. Paragraph 6.1.5.1. of this Regulation shall not apply to a vehicle in respect of which both of the following conditions are satisfied:
 - 6.1.5.2.1. The vehicle is so designed and constructed that no device designed to control the emissions shall be adversely affected by leaded petrol; and
 - 6.1.5.2.2. The vehicle is conspicuously, legibly and indelibly marked with the symbol for unleaded petrol, specified in ISO 2575:2010 "Road vehicles -- Symbols for controls, indicators and tell-tales", in a position immediately visible to a person filling the petrol tank. Additional markings are permitted.
- 6.1.6. Provision shall be made to prevent excess evaporative emissions and fuel spillage caused by a missing fuel filler cap. This may be achieved by using one of the following:
 - 6.1.6.1. An automatically opening and closing, non-removable fuel filler cap;
 - 6.1.6.2. Design features which avoid excess evaporative emissions in the case of a missing fuel filler cap; or
 - 6.1.6.3. Any other provision which has the same effect. Examples may include, but are not limited to, a tethered filler cap, a chained filler cap or one utilising the same locking key for the filler cap as for the vehicle's ignition. In this case, the key shall be removable from the filler cap only in the locked condition.
- 6.1.7. Provisions for electronic system security
 - 6.1.7.1. Any vehicle with an emission control computer, including an evaporative emission control computer, including when integrated in an exhaust emissions control computer, shall include features to deter modification, except as authorised by the manufacturer. The manufacturer shall authorise modifications if those modifications are necessary for the diagnosis, servicing, inspection, retrofitting or repair of the vehicle. Any reprogrammable computer codes or operating parameters shall be resistant to tampering and afford a level of protection at least as good as the provisions in ISO 15031-7: 2013. Any removable calibration memory chips shall be potted, encased in a sealed container or protected by electronic algorithms and shall not be changeable without the use of specialized tools and procedures.
 - 6.1.7.1.1. Only features directly associated with emissions calibration or prevention of vehicle theft may be protected in accordance with paragraph 6.1.7.1.
 - 6.1.7.2. Computer-coded engine operating parameters shall not be changeable without the use of specialized tools and procedures (e.g. soldered or potted computer components or sealed (or soldered) enclosures).
 - 6.1.7.3. Manufacturers may seek approval from the responsible authority for an exemption to one of these requirements for those vehicles that are unlikely to require protection. The criteria that the responsible authority shall evaluate in considering an exemption shall include, but are not limited to, the current availability of performance chips, the high-performance capability of the vehicle and the projected sales volume of the vehicle.
 - 6.1.7.4. Manufacturers using programmable computer code systems shall deter unauthorised reprogramming. Manufacturers shall include enhanced tamper protection strategies and write-protect features requiring electronic access to an off-site computer maintained by the manufacturer. Methods giving an adequate level of tamper protection shall be approved by the responsible authority.

- 6.1.8. Rounding
Unless specified elsewhere in this Regulation, paragraphs 6.1.8.1. and 6.1.8.2. provide rules for rounding to fulfil the requirements of this Regulation.
- 6.1.8.1. When the digit immediately to the right of the last place to be retained is less than 5, that last digit retained shall remain unchanged.
Example:
If a result is 1.234 grams but only two places of decimal are to be retained, the final result shall be 1.23 grams.
- 6.1.8.2. When the digit immediately to the right of the last place to be retained is greater than or equal to 5, that last digit retained shall be increased by 1.
Example:
If a result is 1.236 grams but only two places of decimal are to be retained, and because 6 is greater than 5, the final result shall be 1.24 grams.
- 6.1.9. The use of defeat devices that reduce the effectiveness of emission control systems shall be prohibited. The prohibition shall not apply where:
- (a) the need for the device is justified in terms of protecting the engine against damage or accident and for safe operation of the vehicle;
 - (b) the device does not function beyond the requirements of engine starting;
or
 - (c) the conditions are substantially included in the test procedures for verifying evaporative emissions and average tailpipe emissions.
- 6.2. Test procedure
Table A specifies the various test requirements for type approval of a vehicle.

Table A												
Application of test requirements for type-approval and extensions												
Vehicle category	Vehicles with positive ignition engines including hybrids ^{1,2}								Vehicles with compression ignition engines including hybrids	Pure electric vehicles	Hydrogen fuel cell vehicles	
	Mono fuel				Bi-fuel ³			Flex-fuel ³	Mono fuel			
Reference fuel	Petrol	LPG	NG/ Biomethane	Hydrogen (ICE)	Petrol	Petrol	Petrol	Petrol	Diesel	Petrol	—	Hydrogen (Fuel Cell)
					LPG	NG/ Biomethane	Hydrogen (ICE) ⁴	Ethanol (E85)				
Type 1 test (for applicability of measured components to fuels and vehicle technology and therefore measurement procedures, see Table 1A and Table 1B) (limits)	Yes	Yes ⁵	Yes ⁵	Yes ⁴	Yes (both fuels)	Yes (both fuels)	Yes (both fuels)	Yes (both fuels)	Yes	Yes	—	—
ATCT (14°C test)	Yes	Yes	Yes	Yes ⁴	Yes (both fuels)	Yes (both fuels)	Yes (both fuels)	Yes (both fuels)	Yes	Yes	—	—
Evaporative emissions (Type 4 test)	Yes	Yes	Yes	—	Yes (petrol only)	Yes (petrol only)	Yes (petrol only)	Yes (petrol only)	—	Yes	—	—
Durability (Type 5 test)	Yes	Yes	Yes	Yes	Yes (petrol only)	Yes (petrol only)	Yes (petrol only)	Yes (petrol only)	Yes	Yes	—	—
OBD	Yes	Yes	Yes	Yes	Yes	Yes	Yes	Yes	Yes	Yes		
OBFCM	Yes	—	—	—	—	—	—	Yes (both fuels)	Yes	Yes	—	—

¹ Specific test procedures for hydrogen vehicles will be defined at a later stage.

² Particulate mass and particle number limits and respective measurement procedures shall apply only to vehicles with direct injection engines

³ When a bi-fuel vehicle is combined with a flex fuel vehicle, both test requirements are applicable.

⁴ Only NOx emissions shall be determined when the vehicle is running on hydrogen.

⁵ In the case that a mono-fuel gas vehicle has a petrol tank it shall also be tested using the applicable petrol reference fuel. Particle number limits and respective measurement procedures shall not apply

- 6.2.6. Each of the vehicle families specified below shall be attributed a unique identifier of the following format:

FT-nnnnnnnnnnnnnnn-WMI

Where:

FT is an identifier of the family type:

- IP = Interpolation family as defined in paragraph 6.3.2. with or without using the interpolation method
- RL = Road load family as defined in paragraph 6.3.3.
- RM = Road load matrix family as defined in paragraph 6.3.4.
- PR = Periodically regenerating systems (K_i) family as defined in paragraph 6.3.5.
- AT = ATCT family as defined in paragraph 2. of Annex B6a.
- EV = Evaporative emissions family, as defined in paragraph 6.6.3.
- DF = Durability family, as defined in paragraph 6.7.5.
- OB = OBD family identifier, as defined paragraph 6.8.1.
- ER = Exhaust after-treatment system using reagent (ER)family identifier, as defined in paragraph 6.9.2.
- GV = GFV family identifier, as defined in paragraph 6.3.6.3.

nnnnnnnnnnnnnn is a string with a maximum of fifteen characters, restricted to using the characters 0-9, A-Z and the underscore character '_'.

WMI (world manufacturer identifier) is a code that identifies the manufacturer in a unique manner defined in ISO 3780:2009.

It is the responsibility of the owner of the WMI to ensure that the combination of the string nnnnnnnnnnnnnnn and the WMI is unique to the family and that the string nnnnnnnnnnnnnnn is unique within that WMI to the approval tests performed to obtain the approval.

- 6.3. Description of Type 1 test (WLTP)

The Type 1 test shall be carried out on all vehicles referred to in paragraph 1. The test procedures and requirements of this paragraph and Annexes Part B shall be followed (as applicable).

- 6.3.1. The Type 1 test shall be performed according to:

- (a) The WLTCs as described in Annex B1;
- (b) The gear selection and shift point determination as described in Annex B2;
- (c) The appropriate fuel(s) as specified in Annex B3;
- (d) The road load and dynamometer settings as described in Annex B4;
- (e) The test equipment as described in Annex B5;
- (f) The test procedures as described in Annexes B6 and B8;
- (g) The methods of calculation as described in Annexes B7 and B8.

- 6.3.2. Interpolation family
- 6.3.2.1. Interpolation family for pure ICE vehicles
- 6.3.2.1.1. Vehicles may be part of the same interpolation family in any of the following cases including combinations of these cases:
- (a) They belong to different vehicle classes as described in paragraph 2. of Annex B1;
 - (b) They have different levels of downscaling as described in paragraph 8. of Annex B1;
 - (c) They have different capped speeds as described in paragraph 9. of Annex B1.
- 6.3.2.1.2. Only vehicles that are identical with respect to the following vehicle/power-train/transmission characteristics may be part of the same interpolation family:
- (a) Type of internal combustion engine: fuel type (or types in the case of flex-fuel or bi-fuel vehicles), combustion process, engine capacity, full-load characteristics, engine technology, and charging system, and also other engine subsystems or characteristics that have a non-negligible influence on CO₂ mass emission under WLTP conditions;
 - (b) Operation strategy of all CO₂ mass emission influencing components within the powertrain;
 - (c) Transmission type (e.g. manual, automatic, CVT) and transmission model (e.g. torque rating, number of gears, number of clutches, etc.);
 - (d) n/v ratios (engine rotational speed divided by vehicle speed). This requirement shall be considered fulfilled if, for all transmission ratios concerned, the difference with respect to n/v ratios of the most commonly installed transmission type is within 8 per cent;
 - (e) Number of powered axles.
- 6.3.2.1.3. If an alternative parameter such as a higher n_{\min_drive} , as specified in paragraph 2.(k) of Annex B2, or ASM, as defined in paragraph 3.4. of Annex B2 is used, this parameter shall be the same within an interpolation family.
- 6.3.2.2. Interpolation family for NOVC-HEVs and OVC-HEVs
- In addition to the requirements of paragraph 6.3.2.1. of this Regulation, only OVC-HEVs and NOVC-HEVs that are identical with respect to the following characteristics may be part of the same interpolation family:
- (a) Type and number of electric machines: construction type (asynchronous/ synchronous, etc.), type of coolant (air, liquid) and any other characteristics having a non-negligible influence on CO₂ mass emission and electric energy consumption under WLTP conditions;
 - (b) Type of traction REESS (model, capacity, nominal voltage, nominal power, type of coolant (air, liquid));
 - (c) Type of electric energy converter between the electric machine and traction REESS, between the traction REESS and low voltage power supply and between the recharge-plug-in and traction REESS, and any other characteristics having a non-negligible influence on CO₂ mass

emission and electric energy consumption under WLTP conditions. At the request of the manufacturer and with the approval of the approval authority, electric energy converters between recharge-plug-in and traction REESS with lower recharge losses may be included in the family;

- (d) The difference between the number of charge-depleting cycles from the beginning of the test up to and including the transition cycle shall not be more than one.

6.3.2.3. Interpolation family for PEVs

Only PEVs that are identical with respect to the following electric powertrain/transmission characteristics may be part of the same interpolation family:

- (a) Type and number of electric machines: construction type (asynchronous/ synchronous, etc.), type of coolant (air, liquid) and any other characteristics having a non-negligible influence on electric energy consumption and range under WLTP conditions;
- (b) Type of traction REESS (model, capacity, nominal voltage, nominal power, type of coolant (air, liquid));
- (c) Transmission type (e.g. manual, automatic, CVT) and transmission model (e.g. torque rating, number of gears, numbers of clutches, etc.);
- (d) Number of powered axles;
- (e) Type of electric energy converter between the electric machine and traction REESS, between the traction REESS and low voltage power supply and between the recharge-plug-in and traction REESS, and any other characteristics having a non-negligible influence on electric energy consumption and range under WLTP conditions. At the request of the manufacturer and with the approval of the approval authority, electric energy converters between recharge-plug-in and traction REESS with lower recharge losses may be included in the family.;
- (f) Operation strategy of all components influencing the electric energy consumption within the powertrain;
- (g) n/v ratios (engine rotational speed divided by vehicle speed). This requirement shall be considered fulfilled if, for all transmission ratios concerned, the difference with respect to the n/v ratios of the most commonly installed transmission type and model is within 8 per cent.

6.3.2.4. Interpolation family for OVC-FCHVs and NOVC-FCHVs

Only OVC-FCHVs and NOVC-FCHVs that are identical with respect to the following electric powertrain/fuel cell/transmission characteristics may be part of the same interpolation family:

- (a) Type and number of electric machines: construction type (asynchronous/ synchronous, etc.), type of coolant (air, liquid) and any other characteristics having a non-negligible influence on fuel consumption (or fuel efficiency) and electric energy consumption under WLTP conditions;

- (b) Type of fuel cell (model, nominal voltage, type of coolant (air, liquid)), and also other fuel cell subsystems or characteristics that have a non-negligible influence on fuel consumption (or fuel efficiency) under WLTP conditions;
- (c) Type of traction REESS (model, capacity, nominal voltage, nominal power, type of coolant (air, liquid));
- (d) Transmission type (e.g. manual, automatic, CVT) and transmission model (e.g. torque rating, number of gears, numbers of clutches, etc.);
- (e) Number of powered axles;
- (f) Type of electric energy converter between the electric machine and traction REESS, between the traction REESS and low voltage power supply and between the recharge-plug-in and traction REESS, and any other characteristics having a non-negligible influence on fuel consumption (or fuel efficiency) and electric energy consumption under WLTP conditions. At the request of the manufacturer and with the approval of the approval authority, electric energy converters between recharge-plug-in and traction REESS with lower recharge losses may be included in the family.;
- (g) Operation strategy of all components influencing the fuel consumption (or fuel efficiency) and electric energy consumption within the powertrain;
- (h) n/v ratios. This requirement shall be considered fulfilled if, for all transmission ratios concerned, the difference with respect to the n/v ratios of the most commonly installed transmission type and model is within 8 per cent.

6.3.3. Road load family

Only vehicles that are identical with respect to the following characteristics may be part of the same road load family:

- (a) Transmission type (e.g. manual, automatic, CVT) and transmission model (e.g. torque rating, number of gears, number of clutches, etc.). At the request of the manufacturer and with approval of the responsible authority, a transmission with lower power losses may be included in the family;
- (b) n/v ratios (engine rotational speed divided by vehicle speed). This requirement shall be considered fulfilled if, for all transmission ratios concerned, the difference with respect to the transmission ratios of the most commonly installed transmission type is within 25 per cent;
- (c) Number of powered axles;

If at least one electric machine is coupled in the gearbox position neutral and the vehicle is not equipped with a coastdown mode (paragraph 4.2.1.8.5. of Annex B4) such that the electric machine has no influence on the road load, the criteria in paragraph 6.3.2.2. (a) of this Regulation and paragraph 6.3.2.3. (a) of this Regulation shall apply.

If there is a difference, apart from vehicle mass, rolling resistance and aerodynamics, that has a non-negligible influence on road load, that

vehicle shall not be considered to be part of the family unless approved by the responsible authority.

6.3.4. Road load matrix family

The road load matrix family may be applied for vehicles with a technically permissible maximum laden mass $\geq 3,000$ kg.

Vehicles with a technically permissible maximum laden mass $\geq 2,500$ kg may be part of the road load matrix family provided the driver seat R-point height is above 850 mm from the ground.

“R-point” means “R” point or “seating reference point” as defined in paragraph 2.4. of Annex 1 to the Consolidated Resolution on the Construction of Vehicles (R.E.3.).

Only vehicles which are identical with respect to the following characteristics may be part of the same road load matrix family:

- (a) Transmission type (e.g. manual, automatic, CVT);
- (b) Number of powered axles.

6.3.5. Periodically regenerating systems (Ki) family

Only vehicles that are identical with respect to the following characteristics may be part of the same periodically regenerating systems family:

- (a) Type of internal combustion engine: fuel type, combustion process,
- (b) Periodically regenerating system (i.e. catalyst, particulate trap);
 - (i) Construction (i.e. type of enclosure, type of precious metal, type of substrate, cell density);
 - (ii) Type and working principle;
 - (iii) Volume ± 10 per cent;
 - (iv) Location (temperature ± 100 °C at second highest reference speed).
- (c) The test mass of each vehicle in the family shall be less than or equal to the test mass of the vehicle used for the Ki demonstration test plus 250 kg.

6.3.6. Gas Fuelled Vehicles (GFV) Family

6.3.6.1. GFVs may be grouped into a family of vehicle types fuelled by LPG or NG/biomethane which are then identified by a parent vehicle. For vehicles which can also be fuelled by liquid fuels, this grouping only applies when the vehicle is operated in a gas fuelled mode.

6.3.6.2. A GFV parent vehicle is a vehicle that is selected to act as the vehicle on which the self-adaptability of a fuelling system is going to be demonstrated, and to which the members of a GFV family refer. It is possible to have more than one parent vehicle in a GFV family.

6.3.6.3. Member of the GFV family

6.3.6.3.1. Only vehicles which share the following essential characteristics with its GFV parent(s) may be grouped in a GFV family:

- (a) It is produced by the same manufacturer;
- (b) It is subject to the same emission limits;
- (c) If the gas fuelling system has a central metering for the whole engine:
It has a certified power output between 0.7 and 1.15 times that of the GFV parent vehicle;
- (d) If the gas fuelling system has an individual metering per cylinder:
It has a certified power output per cylinder between 0.7 and 1.15 times that of the GFV parent vehicle;
- (e) If fitted with a catalyst, it has the same type of catalyst i.e. three-way, oxidation, de-NOx;
- (f) It has a gas fuelling system (including the pressure regulator) from the same system manufacturer and of the same type: induction, vapour injection (single point, multipoint), liquid injection (single point, multipoint);
- (g) This gas fuelling system is controlled by an ECU of the same type and technical specification, containing the same software principles and control strategy. The vehicle may have a second ECU compared to the GFV parent vehicle, provided that the ECU is only used to control the injectors, additional shut-off valves and the data acquisition from additional sensors.

6.3.6.3.2. With regard to requirements of paragraph 6.3.6.3.1. (c) and (d):

In the case where a demonstration shows that two gas-fuelled vehicles could be members of the same family with the exception of their certified power output, respectively P1 and P2 ($P1 < P2$), and both are tested as if were parent vehicles the family relation will be considered valid for any vehicle with a certified power output between 0.7 P1 and 1.15 P2.

6.3.7. Additional requirements for vehicles fuelled by LPG or NG/biomethane

6.3.7.1. The additional requirements for vehicles fuelled by LPG or NG/biomethane are provided in Annex B6.

6.3.7.2. For the Type 1 test set out in Annexes Part B, mono-fuel gas vehicles shall be tested in the Type 1 test for variation in the composition of either LPG or NG/biomethane, as set out in Annex B6 for pollutant emissions, with the fuel used for the measurement of the net power in accordance with UN Regulation No. 85.

6.3.7.3. Bi-fuel gas vehicles shall be tested with petrol and either LPG or NG/biomethane. The tests on LPG or NG/biomethane shall be performed for variation in the composition of LPG or NG/biomethane, as set out in Annex B6 for pollutant emissions, and with the fuel used for the measurement of the net power in accordance with UN Regulation No. 85.

6.3.8. Additional requirements for flex fuel vehicles

6.3.8.1. For flex fuel vehicles, the transition from one reference fuel to another between the tests shall take place without manual adjustment of the engine settings.

6.3.9. OBFCM

The OBFCM device shall determine the parameters and store the lifetime values on board the vehicle in accordance to Appendix 5.

6.3.10. Limits for gaseous emissions and the mass of particulates and number of particles (if PN measurement is required)

The resulting masses of gaseous emissions and the mass of particulates and number of particles (if PN measurement is required) obtained shall be less than the limits shown in Table 1A and Table 1B (as applicable):

Table 1A
Emissions limits for the Type 1 test which apply to the emissions from the 4 phases of a WLTP test

Category		Class	Reference mass (RM) (kg)	Limit values													
				Mass of carbon monoxide (CO)		Mass of total hydrocarbons (THC)		Mass of non- methane hydrocarbons (NMHC)		Mass of oxides of nitrogen (NO _x)		Combined mass of hydrocarbons and oxides of nitrogen (THC + NO _x)		Mass of particulate matter (PM)		Particle Number (PN)	
				L ₁ (mg/km)		L ₂ (mg/km)		L ₃ (mg/km)		L ₄ (mg/km)		L ₂ + L ₄ (mg/km)		L ₅ (mg/km)		L ₆ (#/km)	
				PI	CI	PI	CI	PI	CI	PI	CI	PI	CI	PI ¹	CI	PI ¹	CI
M	—	All		1,000	500	100	—	68	—	60	80	—	170	4.5	4.5	6.0 × 10 ¹¹	6.0 × 10 ¹¹
N ₁	I	RM ≤ 1,305		1,000	500	100	—	68	—	60	80	—	170	4.5	4.5	6.0 × 10 ¹¹	6.0 × 10 ¹¹
	II	1,305 < RM ≤ 1,760		1,810	630	130	—	90	—	75	105	—	195	4.5	4.5	6.0 × 10 ¹¹	6.0 × 10 ¹¹
	III	1,760 < RM		2,270	740	160	—	108	—	82	125	—	215	4.5	4.5	6.0 × 10 ¹¹	6.0 × 10 ¹¹
N ₂	—	All		2,270	740	160	—	108	—	82	125	—	215	4.5	4.5	6.0 × 10 ¹¹	6.0 × 10 ¹¹

PI Positive Ignition

CI Compression Ignition

¹ Positive ignition particulate mass and number limits shall apply only to vehicles with direct injection engines.

Table 1B

Emissions limits for the Type 1 test which apply to the emissions from the first 3 phases of a WLTP test

		technically permissible maximum laden mass (GVW) (kg)	Limit values														
			Mass of carbon monoxide (CO)		Mass of non-methane hydrocarbons (NMHC)		Mass of oxides of nitrogen (NO _x)			Mass of particulate matter (PM)							
			L ₁ (mg/km)		L ₃ (mg/km)		L ₄ (mg/km)			L ₅ (mg/km)							
Category	Class		G, O	D			G, O	D	G	D	O			G*1, O	D		
M	—	All	1,150	630			100	24	50	150	150			5	5		
N ₁ , N ₂	—*2	GVW ≤ 1,700	1,150	630			100	24	50	150	150			5	5		
	—	1,700 < GVW ≤ 3,500	2,550	630			150	24	70	240	240			7	7		
	—*3	All	4,020	—			100	—	50	—	150			5	—		

G Petrol, LPG

D Diesel

O Other fuel

¹ For petrol or LPG, particulate mass limits shall apply only to vehicles with direct injection engines.² Except vehicles having engine displacement less than or equal to 0.660 litre, vehicle length less than or equal to 3.40m, vehicle width less than or equal to 1.48m, and vehicle height less than or equal to 2.00m, seats less than or equal to 3 in addition to a driver, and payload less than or equal to 350kg³ Vehicles having engine displacement less than or equal to 0.660 litre, vehicle length less than or equal to 3.40m, vehicle width less than or equal to 1.48m, and vehicle height less than or equal to 2.00m, seats less than or equal to 3 in addition to a driver, and payload less than or equal to 350kg

- 6.4. [Reserved]
- 6.5. [Reserved]
- 6.6. Type 4 test (Determination of evaporative emissions)
- 6.6.1. The Type 4 test shall be carried out on all vehicles with a petrol tank in accordance with the requirements of paragraphs 6.6.2. to 6.6.4. and Annex C3.
- 6.6.2. When tested in accordance with Annex C3 to this Regulation, evaporative emissions shall be less than that specified in Table 2.

Table 2

Emission limit for evaporative emissions test

Mass of Evaporative Emission (g/test)
2.0

- 6.6.3. Evaporative emission family
- 6.6.3.1. Only vehicles that are identical with respect to the characteristics listed in (a), (d) and (e), technically equivalent with respect to the characteristics listed in (b) and (c) and similar or, where applicable, within the stated tolerance regarding the characteristics listed in (f) and (g) may be part of the same evaporative emission family:
 - (a) Fuel tank system material and construction;
 - (b) Vapour hose material;
 - (c) Fuel line material and connection technique;
 - (d) Sealed tank or non-sealed tank system;
 - (e) Fuel tank relief valve setting (air ingestion and relief);
 - (f) Carbon canister butane working capacity (BWC300) within a 10 per cent range of the highest value (for carbon canisters with the same type of charcoal, the volume of charcoal shall be within 10 per cent of that for which the BWC300 was determined);
 - (g) Purge control system (for example, type of valve, purge control strategy).

The manufacturer shall demonstrate the technical equivalence of points (b) and (c) to the responsible authority.
- 6.6.3.2. The vehicle shall be considered to produce worst-case evaporative emissions and shall be used for testing if it has the largest ratio of fuel tank capacity to BWC300 within the family. The vehicle selection shall be agreed in advance with the responsible authority.
- 6.6.3.3. The use of any innovative system calibration, configuration, or hardware related to the evaporative control system shall place the vehicle model in a different family.
- 6.6.4. The responsible authority shall not grant type approval if the information provided is insufficient to demonstrate that the evaporative emissions are effectively limited during the normal use of the vehicle.
- 6.7. Type 5 test (Description of the endurance test for verifying the durability of pollution control devices)
- 6.7.1. This test shall be carried out on all vehicles referred to in paragraph 1. to which the test specified in paragraph 6.3. applies. The test represents an ageing test

up to the target useful life driven in accordance with the programme described in Annex C4 to this Regulation on a test track, on the road or on a chassis dynamometer.

The target useful life is 160,000 km.

- 6.7.1.1. Vehicles that can be fuelled either with petrol or with LPG or NG should be tested in the Type 5 test on petrol only. In that case the deterioration factor found with unleaded petrol will also be taken for LPG or NG.
- 6.7.1.2. Special requirements for hybrid vehicles are provided in Appendix 4 to Annex C4.
- 6.7.2. Notwithstanding the requirement of paragraph 6.7.1., a manufacturer may choose to have the deterioration factors from Tables 3a and 3b used as an alternative to testing to paragraph 6.7.1.

Table 3a

Multiplicative Deterioration factors (for emissions measurements to be compared against the limits in Table 1A)

Engine Category	Assigned multiplicative deterioration factors						
	CO	THC	NMHC	NO _x	HC + NO _x	Particulate Matter (PM)	Particles (PN)
Positive ignition	1.5	1.3	1.3	1.6	-	1.0	1.0
Compression-ignition	As there are no assigned deterioration factors for compression ignition vehicles, manufacturers shall use the whole vehicle or bench ageing durability test procedures to establish deterioration factors.						

Table 3b

Additive Deterioration factors (for emissions measurements to be compared against the limits in Table 1B)

Engine Category	Assigned additive deterioration factors					
	CO		NMHC	NO _x		PM
Gasoline fuel and LPG	0.11		0.12	0.21		0.00
Compression-ignition	As there are no assigned deterioration factors for compression ignition vehicles, manufacturers shall use the whole vehicle ageing durability test procedures to establish deterioration factors.					

- 6.7.3. [Reserved]
- 6.7.4. Deterioration factors are determined using one of the procedures specified in paragraph 1.1. of Annex C4 (as applicable). The factors are used to establish compliance with the requirements of paragraphs 6.3. and 8.2.
- 6.7.5. Durability family
- Only vehicles whose engine or pollution control system parameters are identical or remain within the prescribed tolerances with reference to the vehicle used for the determination of the Deterioration Factor may be part of the same Durability family:

- (a) Engine
 - (i) ratio between engine cylinder capacity and the volume of each catalytic component and/or filter (-10 to +5 per cent);
 - (ii) difference in engine capacity within either ± 15 per cent of the capacity of the tested vehicle or 820 cm³ whichever value is lower;
 - (iii) cylinder configuration (number of cylinders, shape, distance between bores and other configurations);
 - (iv) number of valves, control of valves, and camshaft driven method;
 - (v) fuel type and fuel system,
 - (vi) combustion process.
- (b) Pollution control system parameters:
 - (i) Catalytic converters and particulate filters:
 - number and layout of catalytic converters, filters and elements,
 - type of catalytic activity (oxidizing, three-way, lean NO_x trap, SCR, lean NO_x catalyst or other), and filtering characteristics;
 - precious metal load (identical or higher),
 - precious metal type and ratio (± 15 per cent),
 - substrate (structure and material),
 - cell density.
 - (ii) Air injection:
 - with or without
 - type (pulsair, air pumps, other(s))
 - (iii) EGR:
 - with or without
 - type (cooled or non-cooled, active or passive control, high pressure/low pressure/combined pressure).
 - (iv) other devices having an influence on durability.

6.8. On-board diagnostics OBD – Test

This test shall be carried out on vehicle types as indicated in Table A. The test procedure described in paragraph 3. of Annex C5 to this Regulation shall be followed.

6.8.1. OBD family

6.8.1.1. Parameters defining the OBD family

The OBD family means a manufacturer's grouping of vehicles which, through their design, are expected to have similar exhaust emission and OBD system characteristics. Each engine of this family shall comply with the requirements of this Regulation.

The OBD family may be defined by basic design parameters which shall be common to vehicles within the family. In some cases there may be interaction of parameters. These effects shall also be taken into consideration to ensure that only vehicles with similar exhaust emission characteristics are included within an OBD family.

6.8.1.2. To this end, those vehicles whose parameters described below are identical may be considered to belong to the same OBD family.

Engine:

- (a) Combustion process (i.e. positive ignition, compression-ignition, two-stroke, four-stroke/rotary);
- (b) Method of engine fuelling (i.e. single or multi-point fuel injection); and
- (c) Fuel type (i.e. petrol, diesel, flex fuel petrol/ethanol, flex fuel diesel/biodiesel, NG/biomethane, LPG, bi fuel petrol/NG/biomethane, bi-fuel petrol/LPG).

Emission control system:

- (a) Type of catalytic converter (i.e. oxidation, three-way, heated catalyst, SCR, other);
- (b) Type of particulate trap;
- (c) Secondary air injection (i.e. with or without); and
- (d) Exhaust gas recirculation (i.e. with or without);

OBD parts and functioning.

The methods of OBD functional monitoring malfunction detection and malfunction indication to the vehicle driver.

[6.8.2. OBD thresholds

The OBD thresholds referred to in Annex C5 are specified in Table 4A and Table 4B.

Table 4A

OBD thresholds

		Reference mass (RM) (kg)	Mass of carbon monoxide		Mass of non- methane hydrocarbons		Mass of oxides of nitrogen		Mass of particulate matter ¹	
			(CO) (mg/km)		(NMHC) (mg/km)		(NO _x) (mg/km)		(PM) (mg/km)	
Category	Class		PI	CI	PI	CI	PI	CI	CI	PI
M	—	All	1,900	1,750	170	290	90	140	12	12
N ₁	I	RM ≤ 1305	1,900	1,750	170	290	90	140	12	12
	II	1305 < RM ≤ 1760	3,400	2,200	225	320	110	180	12	12
	III	1760 < RM	4,300	2,500	270	350	120	220	12	12
N ₂	—	All	4,300	2,500	270	350	120	220	12	12

PI Positive Ignition

CI Compression Ignition.

¹ Positive ignition particulate mass and number limits apply only to vehicles with direct injection engines

Table 4B
OBD thresholds

		Reference mass (RM) (kg)	Mass of carbon monoxide		Mass of non- methane hydrocarbons		Mass of oxides of nitrogen		Mass of particulate matter ¹	
			(CO) (mg/km)		(NMHC) (mg/km)		(NO _x) (mg/km)		(PM) (mg/km)	
Category	Class		G	D	G	D	G	D	G	D
M	—	All	4,060	—	320	—	300	—	—	—
N ₁ , N ₂	—* ¹	GVW ≤ 1,700	4,060	—	320	—	300	—	—	—
	—	1,700 < GVW ≤ 3,500	8,960	—	460	—	410	—	—	—
	—									
	—* ²	All	14,120	—	320	—	300	—	—	—

G Petrol, LPG

D Diesel

¹ Except vehicles having engine displacement less than or equal to 0.660 litre, vehicle length less than or equal to 3.40 m, vehicle width less than or equal to 1.48 m, and vehicle height less than or equal to 2.00 m, seats less than or equal to 3 in addition to a driver, and payload less than or equal to 350 kg

² Vehicles having engine displacement less than or equal to 0.660 litre, vehicle length less than or equal to 3.40 m, vehicle width less than or equal to 1.48 m, and vehicle height less than or equal to 2.00 m, seats less than or equal to 3 in addition to a driver, and payload less than or equal to 350 kg

6.9. Vehicles that use a reagent for the exhaust after-treatment system

6.9.1. Vehicles that use a reagent for the exhaust after-treatment system shall meet the requirements specified in Appendix 6 to this Regulation.

6.9.2. Exhaust after-treatment system using reagent (ER) family definition

Only vehicles that are identical with respect to the following characteristics may be part of the same ER family:

- Reagent injector (principle, construction)
- Reagent injector location
- Detection strategies (for reagent level, dosing and quality or for reagent level and monitoring NO_x emissions)
- Warning display: messages, tell-tales lighting sequences and audible component sequences, if any
- Inducement option
- NO_x sensor (application of option described in paragraph 6 of Appendix 6) or reagent quality sensor (application of option described in paragraphs 4 and 5 of Appendix 6)

The manufacturer and the approval authority shall agree which vehicle model is representative for the ER family.

7. Modification and extension of the type approval

7.1. Every modification of the vehicle type shall be notified to the Type Approval Authority that approved the vehicle type. The Type Approval Authority may then either:

7.1.1. Consider that the modifications made are contained within the families covered by the approval or are unlikely to have an appreciable adverse effect on the values of CO₂ and fuel consumption or electric energy consumption and that, in this case, the original approval will be valid for the modified vehicle type; or

7.1.2. Require a further test report from the Technical Service responsible for conducting the tests.

7.2. Confirmation or refusal of approval, specifying the alterations, shall be communicated by the procedure specified in paragraph 5.3. to the Contracting Parties to the Agreement which apply this Regulation.

7.3. The Type Approval Authority issuing the extension of approval shall assign a series number to the extension and inform thereof the other Contracting Parties to the 1958 Agreement applying this Regulation by means of a communication form conforming to the model in Annex A2 to this Regulation.

7.4. Extensions for tailpipe emissions (Type 1 test) and OBFCM

7.4.1. The type-approval shall be extended without the need for further testing to vehicles if they conform to the criteria of paragraph 3.0.1. (a) and (c).

Additionally to the criteria above, in the cases when the Interpolation Family Vehicle High and/ or Vehicle Low are changed, the new Vehicle High and/or Vehicle Low shall be tested and the CO₂ emission of the tested vehicle resulting from step 9 of Table A7/1 of Annex B7 and step 8 of Table A8/5 in Annex B8 shall be less than or equal to the CO₂ emission which lies on a straight line through the CO₂ values of the original Vehicles Low and High when plotted against cycle energy and corresponding to the cycle energy demand of the tested vehicle.

The measured criteria emissions shall respect the limits set out in paragraph 6.3.10.

The accuracy of the OBFCM shall be calculated for any Type 1 tests performed in order to gain an extension and shall respect the criteria set out in paragraph 4.2 of Appendix 5.

7.4.1.1. If The type-approval has been granted only in relation to Vehicle High, it shall only be extended under the circumstances (a), (b) or (c) below:

(a) to include additional vehicles which conform to the criteria of paragraph 3.0.1. (a) and (c) and have a cycle energy lower than that of Vehicle High.

(b) to create an interpolation family by testing Vehicle Low (preferably using the vehicle which was tested as Vehicle High for the original approval). In this case all vehicles covered by the extended approval shall conform to the criteria of paragraph 3.0.1. (a), (b) and (c).

(c) to create an interpolation family by renaming Vehicle High as Vehicle Low and testing Vehicle High (preferably using the vehicle which was tested as Vehicle High for the original approval). In this case all vehicles covered by the extended approval shall conform to the criteria of paragraph 3.0.1. (a), (b) and (c).

- 7.4.2. Vehicles with periodically regenerating systems
- For Ki tests undertaken under Appendix 1 to Annex B6, the type-approval shall be extended to vehicles if they conform to the criteria of paragraph 6.3.5. of this Regulation.
- 7.5. Extensions for evaporative emissions (Type 4 test)
- 7.5.1. For tests performed in accordance with Annex C3 the type-approval shall be extended to vehicles belonging to an approved evaporative emission family as defined in paragraph 6.6.3. of this Regulation.
- 7.6. Extensions for durability of pollution control devices (Type 5 test)
- 7.6.1. For tests performed in accordance with Annex C4 the deterioration factors shall be extended to different vehicles and vehicle types, provided that both of the following conditions apply:
- (a) The vehicles belong to the same Durability family, as defined in the paragraph 6.7.5. of this Regulation;
 - (b) The worst case Deterioration Factor (DF) derived within the Durability Family is applied. If vehicles with a cycle energy demand higher than that of the vehicle for which the DFs were established are to be included by extension, the worst case DF is determined on the vehicle with the highest temperature at the inlet of the pollution control system, measured as prescribed in paragraph 7.6.2.
- 7.6.2. The temperature at the inlet of the pollution control device shall be lower than the temperature of the vehicle tested for DF determination plus 50°C. It shall be checked under following stabilized conditions. A vehicle meeting the requirements of paragraph 1.2. of Annex C4 for the extended durability family shall be brought to a speed of the maximum vehicle speed minus 10km/h or 120 km/h, whichever is lower, and kept at that constant speed for at least 15 minutes at the load setting of the Type 1 test. At any time after this period, the temperature at catalyst inlet shall be measured for at least 2 continued minutes while the vehicle is kept at that constant speed and the average temperature value shall be taken as representative value.
- 7.7. Extension for OBD
- For OBD the type approval can be extended to vehicles belonging to an approved OBD family as defined in paragraph 6.8.1. of this Regulation.

8. Conformity of production (COP)

- 8.1. Every vehicle produced under a type approval according to this Regulation shall conform with regard to the vehicle type approved. The conformity of production procedures shall comply with those set out in the 1958 Agreement, Schedule 1 (E/ECE/324-E/ECE/TRANS/505/Rev.3), with the following requirements:
- 8.1.1. The manufacturer shall implement adequate arrangements and documented control plans and carry-out, at intervals specified in this Regulation, the necessary tests to verify continued conformity with the approved type. The manufacturer shall obtain agreement for these arrangements and control plans from the responsible authority. The responsible authority shall perform audits at specific intervals. This audit shall include production and test facilities as part of the product conformity and continued verification arrangements. Where necessary the responsible authority may require additional tests to be conducted.
- 8.1.2. The manufacturer shall check the conformity of production by conducting the appropriate tests in accordance with Table 8/1 and 8/2 of this Regulation and with the OBD requirements, where applicable according to Table A in

paragraph 6. Where applicable and if required according to Table A, the manufacturer shall determine and report the OBFCM device accuracy in accordance with Appendix 5.

The specific procedures for conformity of production are set out in paragraphs 8.2. to 8.4. and Appendices 1 to 4.

Table 8/1

Type 1 Applicable Type-1 CoP requirements for the different types of vehicle

<i>Type of vehicle</i>	<i>Criteria emissions</i>	<i>CO₂ emissions</i>	<i>Fuel Efficiency</i>	<i>Electric energy consumption</i>
Pure ICE	Yes	As applicable	As applicable	Not Applicable
NOVC-HEV	Yes	As applicable	As applicable	Not Applicable
OVC-HEV	Yes: CD ⁽¹⁾ and CS	As applicable: CS only	As applicable: CS only	Yes: CD only
PEV	Not Applicable	Not Applicable	Not Applicable	Yes
NOVC-FCHV	Not Applicable	Not Applicable	Exempted	Not Applicable
OVC-FCHV	Not Applicable	Not Applicable	Exempted	Exempted

⁽¹⁾ Only if there is combustion engine operation during a valid CD Type 1 test for CoP verification

Table 8/2

Type 4 Applicable Type 4 CoP requirements for the different vehicle types

<i>Vehicle type</i>	<i>Evaporative emissions</i>
ICE	Yes ⁽¹⁾
NOVC-HEV	Yes ⁽¹⁾
OVC-HEV	Yes ⁽¹⁾
PEV	Not Applicable
NOVC-FCHV	Not Applicable
OVC-FCHV	Not Applicable

⁽¹⁾ only for vehicles fuelled by petrol

8.1.3. CoP family

The manufacturer is allowed to split the CoP family into smaller CoP families.

If the vehicle production takes place in different production facilities, different CoP families shall be created for each facility.

The manufacturer may request to merge these CoP families.

At the request of the manufacturer, CoP families from different production facilities may be merged. For Type 1 testing this is only permitted if the planned annual production volume of each production plant is less than 1,000. The responsible authority shall evaluate on the basis of the supplied evidence by the manufacturer whether such a merge is justified.

- 8.1.3.1. CoP family for Type 1 test
- For the purposes of the manufacturer's conformity of production check on the Type 1 test, including, where applicable and if required, the determination of the OBFCM device accuracy, the family means the conformity of production (CoP) family as specified in paragraphs 8.1.3.1.1. and 8.1.3.1.2.
- 8.1.3.1.1. For interpolation families as described in paragraph 6.3.2. of this Regulation with a planned vehicle production volume of more than 1,000 vehicles per 12 months, the CoP family for the Type 1 test shall be identical to the interpolation family.
- 8.1.3.1.2. For interpolation families as described in paragraph 6.3.2. of this Regulation with a planned production volume of 1,000 vehicles or less per 12 months, it is allowed to include other interpolation families into the same CoP family, up to a combined maximum production volume of 5,000 vehicles per 12 months. At the request of the responsible authority the manufacturer shall provide evidence on the justification and technical criteria for merging these interpolation families, ensuring that there is a large similarity between those families, for example in the following cases:
- two or more interpolation families are merged which were split because the maximum interpolation range of 30 g/km CO₂ is exceeded;
 - interpolation families that were split because there are different engine power ratings of the same combustion engine;
 - interpolation families that were split because the n/v ratios are just outside the tolerance of 8%;
 - interpolation families that were split, but still fulfil all the family criteria of a single IP family.
- 8.1.3.2. CoP family for Type 4 test
- For the purposes of the manufacturer's conformity of production check on the Type 4 test, the family means the conformity of production (CoP) family, which shall be identical to the evaporative emissions family, as described in paragraph 6.6.3. of this Regulation.
- 8.1.3.3. CoP family for OBD
- For the purposes of the manufacturer's conformity of production check on OBD, the family means the conformity of production (CoP) family, which shall be identical to the OBD family, as described in paragraph 6.8.1. of this Regulation.
- 8.1.4. Test frequency for the Type 1 test
- 8.1.4.1. The frequency for product verification on the Type 1 test performed by the manufacturer shall be based on a risk assessment methodology consistent with the international standard ISO 31000:2018 — Risk Management — Principles and guidelines, and shall have a minimum frequency per CoP family of one verification per 12 months.
- 8.1.4.2. If the number of vehicles produced within the CoP family exceeds 7,500 vehicles per 12 months, the minimum verification frequency per CoP family shall be determined by dividing the planned production volume per 12 months by 5,000 and mathematically rounding this number to the nearest integer.
- 8.1.4.3. If the number of vehicles produced within the CoP family exceeds 5,000 vehicles per month, the frequency per CoP family shall be at least one verification per month.
- 8.1.4.4. The product verifications shall be evenly distributed over the period of 12 months or over the production period in the case that this is less than 12 months. The last product verification shall reach a decision within 12 months unless the

manufacturer can justify that an extension of a maximum of one month is necessary.

- 8.1.4.5. The planned production volume of the CoP family per a 12-month period shall be monitored by the manufacturer on a monthly basis, and the responsible authority shall be informed if any change in the planned production volume causes changes to either the size of the CoP family or the Type 1 test frequency.

- 8.1.5. Test frequency for the Type 4 test

Once per year a vehicle shall be randomly taken from the CoP family described in paragraph 8.1.3.2. to this annex and subjected to the three tests described in Appendix 4.

- 8.1.6. Audits by the responsible authority

The responsible authority shall perform audits for verifying the manufacturer's arrangements and documented control plans at the facility of the manufacturer, in all cases, with a minimum frequency of one audit per 12 months.

Where the interpolation method is used, verification of the interpolation calculation may be carried out by, or at the request of, the responsible authority as part of the audit process.

If the responsible authority is not satisfied with the audit results, physical tests shall directly be carried out on production vehicles as described in paragraphs 8.2. to 8.4 to verify the conformity of the vehicle production.

The manufacturers arrangements and documented control plans shall be based on a risk assessment methodology consistent with the international standard ISO 31000:2009 — Risk Management — Principles and guidelines.

- 8.1.7. Physical test verifications by the responsible authority

The normal frequency of physical test verifications by the responsible authority shall be based on the results of the auditing procedure of the manufacturer on a risk assessment methodology and in all cases with a minimum frequency of one verification test per three years. The responsible authority shall conduct these physical emission tests on production vehicles as described in paragraphs 8.2. to 8.4.

In the case that the manufacturer is conducting the physical tests, the responsible authority shall witness these tests at the manufacturer's facility.

- 8.1.8. Reporting

The responsible authority shall report the results of all audit checks and physical tests performed on verifying conformity of the manufacturers and file it for a period of a minimum of 10 years. These reports should be available for other responsible authorities

- 8.1.9. Non-conformity

In the case that a non-conformity is observed, Article 4 of the 1958 Agreement shall apply.

- 8.2. Checking the conformity for a Type 1 test

- 8.2.1. The Type 1 test shall be carried out on a minimum of three production vehicles, which shall be valid members of the CoP family as described in paragraph 8.1.3.1.

- 8.2.2. Vehicles shall be selected at random in the CoP family. The manufacturer shall not undertake any adjustment to the vehicles selected.

In the case that vehicles in the CoP family are assembled in different production facilities, at the request of the responsible authority the manufacturer shall adapt the selection of vehicles from across the different

production facilities, without prejudice to the principle of random selection within a production facility.

In the case that multiple IP families are included in the CoP family, at the request of the responsible authority the manufacturer shall adapt the selection of vehicles from across the different interpolation families, without prejudice to the principle of random selection within an interpolation family.

8.2.3. Type 1 test procedure

8.2.3.1. Where applicable, in accordance with Table 8/1, the verification of the criteria emissions, CO₂ emissions, fuel efficiency and electric energy consumption, shall be carried out in accordance with the specific requirements and procedures in Appendix 1. Where applicable and if required, the manufacturer shall determine and report the OBFCM device accuracy in accordance with Appendix 5.

8.2.3.2. The statistical procedure for calculating the test criteria and to arrive at a pass or fail decision is described in Appendix 2 and in the flowchart of Figure 8/1.

Where applicable, in accordance with Table 8/1, the production of a CoP family shall be deemed to not conform when a fail decision is reached in accordance with the test criteria in Appendix 2. for one or more of the criteria emissions, CO₂ emissions, fuel efficiency or electric energy consumption.

Where applicable, in accordance with Table 8/1, the production of a CoP family shall be deemed to conform once a pass decision is reached in accordance with the test criteria in Appendix 2 for all the criteria emissions, CO₂ emissions, fuel efficiency or electric energy consumption.

Where applicable, in accordance with Table 8/1, when a pass decision has been reached for one criteria emission, that decision shall not be changed by any additional tests carried out to reach a decision for the other criteria emissions, CO₂ emissions, fuel efficiency or electric energy consumption.

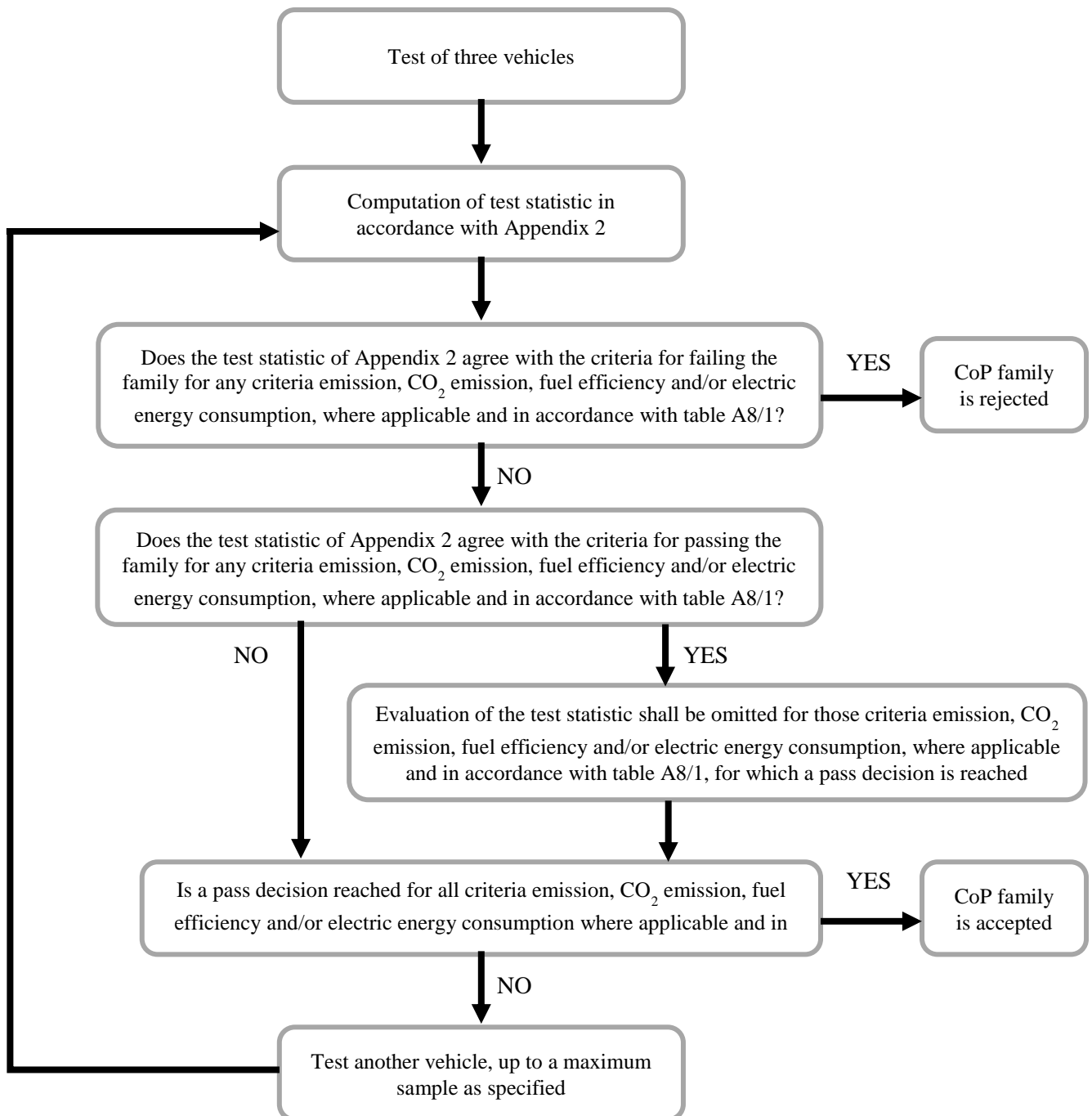
Where applicable, in accordance with Table 8/1, if a pass decision is not reached for all the criteria emissions, CO₂ emissions, fuel efficiency or electric energy consumption, if applicable, in accordance with Table 8/1, another vehicle is added to the sample by selecting this according to paragraph 8.2.2. and performing the Type 1 test. The statistical procedure described in Appendix 2 shall be repeated until a pass decision is reached for all the criteria emissions, CO₂ emissions, fuel efficiency or electric energy consumption.

The maximum sample size shall be:

16 vehicles for CO₂ emissions, fuel efficiency and electric energy consumption.

32 vehicles for criteria emissions

Figure 8/1
Flowchart of the CoP test procedure for the Type 1 test



- 8.2.4. Run-in factors
- 8.2.4.1. At the request of the manufacturer and with the acceptance of the responsible authority, a run-in test procedure may be carried out on a vehicle of the CoP family to establish derived run-in factors for criteria emissions, CO₂ emissions, fuel efficiency and/or electric energy consumption according to the test procedure in Appendix 3.
- 8.2.4.2. For the application of derived run-in factors, the system odometer of the CoP test vehicle D_j shall preferably be within -10 km of the mileage at the start of the 1st test and +10 km of the mileage at the start of the 2nd test on the run-in test vehicle D_i, prior to when it was run in.
- 8.2.4.3. At the option of the manufacturer, for CO₂ emissions, in g/km an assigned run-in factor of 0.98 may be applied if the system odometer setting at the start of the CoP test is less than or equal to 80 km.
- At the option of the manufacturer, for fuel efficiency, in km/l, an assigned run-in factor of 1.02 may be applied if the system odometer setting at the start of the CoP test is less than or equal to 80 km.
- If the assigned run-in factors for CO₂ emissions and fuel efficiency are applied, no run-in factors shall be applied for criteria emissions and electric energy consumption.
- 8.2.4.4. The run-in factor shall be applied to the CoP test result that is calculated according to Step 4c of Table A7/1 in Annex B7 or Step 4c in Table A8/5 of Annex B8.
- 8.2.5. Test fuel
- 8.2.5.1. For the Type 4 test, the reference fuel shall be used in accordance with the specifications in paragraph 7. of Annex B3.
- All remaining tests shall be conducted with reference fuels in accordance with the specifications in Annex B3 for the Type 1 test. However, at the request of the manufacturer the mileage accumulation for the run-in in paragraph 1.7 of Appendix 3 may be conducted with commercial fuel.
- 8.2.5.2. Tests for conformity of production of vehicles fuelled by LPG or NG/biomethane may be performed with a commercial fuel of which the C3/C4 ratio lies between those of the reference fuels in the case of LPG, or of one of the high or low caloric fuels in the case of NG/biomethane. In all cases a fuel analysis shall be presented to the responsible authority.
- 8.2.6. Criteria for validity of speed trace tolerances and drive trace indices of the Type 1 CoP test
- The speed trace tolerances and drive trace indices shall fulfil the criteria specified in paragraph 2.6.8.3. of Annex B6.
- 8.3. Checking the conformity for a Type 4 test
- 8.3.1. The production shall be deemed to conform if the vehicle selected and tested according to paragraph 8.1.5. of this Annex meets the requirements of all of those tests.
- 8.3.2. If the vehicle tested does not satisfy the requirements of paragraph 8.3.1., a further random sample of four vehicles shall be taken from the same family without unjustified delay and subjected to the tests described in Appendix 4.
- The production shall be deemed to conform if the requirements are met for at least three of these vehicles within 6 months after the initial failed test has been detected.
- 8.3.3. If the vehicles tested do not satisfy the requirements of paragraph 8.3.2., a further random sample shall be taken from the same family without unjustified delay and subjected to the tests described in Annex C3.

If the vehicle tested does not satisfy the requirements of Annex C3, a further random sample of four vehicles shall be taken from the same family and also subjected without unjustified delay to the tests described in Annex C3.

On request of the manufacturer, for CoP tests described in Annex C3 the Permeability Factor (PF) derived at Type Approval or the Assigned Permeability Factor (APF) may be applied

The production shall be deemed to conform if the requirements are met for at least three of these vehicles within 24 months after the initial failed test has been detected.

8.3.3.1. For CoP tests described in Annex C3 which are performed on a vehicle which has completed a mileage of less than 20,000 km a canister which has been aged according to paragraph 5.1. of Annex C3 shall be used. This can be the original canister from the test vehicle or another canister of identical specification. On request of the manufacturer for these tests either the Permeability Factor (PF) as defined in the paragraph 5.2 of Annex C3 which was established at Type Approval for the evaporative family or the Assigned Permeability Factor (APF) also defined in the paragraph 5.2 of Annex C3 shall be applied.

8.3.3.2. On request of the manufacturer, CoP tests described in Annex C3 may be carried out on a vehicle which has completed a minimum mileage of 20,000 km up to a maximum of 30,000 km with no modifications to the vehicle other than those described in the test procedure. When the test is carried out on a vehicle which has completed a mileage of between 20,000 km and 30,000 km, the canister aging shall be omitted and the Permeability Factor or Assigned Permeability Factor shall not be applied.

Independent of the accumulated mileage of the vehicle, non-fuel background emission sources (e.g. paint, adhesives, plastics, fuel/vapour lines, tyres, and other rubber or polymer components) can be eliminated according to paragraph 6.1. of Annex C3.

8.4. Checking the conformity of the vehicle for On-board Diagnostics (OBD)

8.4.1. When the approval authority determines that the quality of production seems unsatisfactory, a vehicle shall be randomly taken from the family and subjected to the tests described in Appendix 1 to Annex C5.

8.4.2. The production shall be deemed to conform if this vehicle meets the requirements of the tests described in Appendix 1 to Annex C5.

8.4.3. If the vehicle tested does not satisfy the requirements of section 8.4.1., a further random sample of four vehicles shall be taken from the same family and subjected to the tests described in Appendix 1 to Annex C5. The tests may be carried out on vehicles which have completed a maximum of 15,000 km with no modifications.

8.4.4. The production shall be deemed to conform if at least three vehicles meet the requirements of the tests described in Appendix 1 to Annex C5.

9. Penalties for non-conformity of production

9.1. The approval granted in respect of a vehicle type pursuant to this Regulation, may be withdrawn if the requirements laid down in paragraph 8.1. are not complied with or if the vehicle or vehicles taken fail to pass the tests prescribed in paragraph 8.1.2.

9.2. If a Contracting Party to the 1958 Agreement which applies this Regulation withdraws an approval it has previously granted, it shall forthwith so notify the other Contracting Parties applying this Regulation, by means of a communication form conforming to the model in Annex A2 to this Regulation.

10. Production definitively discontinued

If the holder of the approval completely ceases to manufacture a type of vehicle approved in accordance with this Regulation, they shall so inform the Type Approval Authority which granted the approval. Upon receiving the relevant communication, that authority shall inform thereof the other Contracting Parties to the 1958 Agreement applying this Regulation by means of copies of the communication form conforming to the model in Annex A2 to this Regulation.

11. Special Provisions

- 11.1. By way of derogation to the obligations of Contracting Parties, the Contracting Parties applying this Regulation may refuse to accept type approvals granted on the basis of Level 1A or Level 1B to this Regulation.

12. Transitional Provisions

- 12.1. As from the official date of entry into force of the 01 series of amendments to this Regulation, and by way of derogation to the obligations of Contracting Parties, the Contracting Parties applying this Regulation and also applying the 08 or a later series of amendments to UN Regulation No. 83 may refuse to accept type approvals granted on the basis of this Regulation which are not accompanied by an approval to the 08 or a later series of amendments to UN Regulation No. 83.

13. Names and addresses of Technical Services responsible for conducting approval tests, and of Type Approval Authorities

The Contracting Parties to the 1958 Agreement which apply this Regulation shall communicate to the United Nations Secretariat the names and addresses of the Technical Services responsible for conducting approval tests and of the Type Approval Authorities which grant approval and to which forms certifying approval or extension or refusal or withdrawal of approval, issued in other countries, are to be sent.

Appendix 1

Type 1 test CoP verification for specific vehicle types

1. Verifying CoP on the criteria emissions for pure ICE vehicles, NOVC-HEVs and OVC-HEVs
 - 1.1. Each vehicle shall be tested on the chassis dynamometer set with the specific mass inertia setting and road load parameters of the individual vehicle. The chassis dynamometer shall be set to the target road load for the test vehicle according to the procedure specified in paragraph 7. of Annex B4.
 - 1.2. The applicable test cycle is the same used for the type approval of the interpolation family to which the vehicle belongs.
 - 1.3. The preconditioning test shall be carried out according to the provisions of paragraph 2.6. of Annex B6, or of Appendix 4 to Annex B8, as applicable.
 - 1.4. The test results shall be the values calculated for pure ICE vehicles according to Step 9 of Table A7/1 of Annex B7, for NOVC-HEVs and OVC-HEVs according to Step_8 of Table A8/5 of Annex B8 for the charge-sustaining criteria emissions and according to Step 6 of Table A8/8 of Annex B8 for the charge-depleting criteria emissions. Conformity against the applicable criteria emission limits shall be checked using the pass/fail criteria specified in paragraph 6.3.10. of this Regulation.
2. Verification of CoP on CO₂ mass emissions/ fuel efficiency of pure ICE vehicles
 - 2.1. The vehicle shall be tested according to the Type 1 test procedure described in Annex B6.
 - 2.2. During this test, the CO₂ mass emission $M_{CO_2,C,6}$ shall be determined according to step 6 of Table A7/1 of Annex B7.
During this test, the fuel efficiency FE_{c5} shall be determined according to step 5 of Table A7/1 of Annex B7.
 - 2.3. The conformity of production with regard to CO₂ mass emissions shall be verified on the basis of the values for the tested vehicle as described in paragraph 2.3.1. and applying a run-in factor as defined in paragraph 8.2.4. of this annex.
The conformity of production with regard to fuel efficiency shall be verified on the basis of the values for the tested vehicle as described in paragraph 1.3.1. and applying a run-in factor as defined in paragraph 8.2.4. of this annex.
 - 2.3.1. CO₂ mass emission values for CoP / Fuel efficiency values for CoP
In the case the interpolation method is not applied, the CO₂ mass emission value $M_{CO_2,c,7}$ according to step 7 of Table A7/1 of Annex B7 shall be used for verifying the conformity of production.
In the case the interpolation method is applied, the CO₂ mass emission value $M_{CO_2,c,ind}$ for the individual vehicle according to step 10 of Table A7/1 of Annex B7 shall be used for verifying the conformity of production.
In the case the interpolation method is not applied, the fuel efficiency value $FE_{C,8}$ according to step 8 of Table A7/1 of Annex B7 shall be used for verifying the conformity of production.
In the case the interpolation method is applied, the fuel efficiency value $FE_{c,ind}$ for the individual vehicle according to step 10 of Table A7/1 shall be used for verifying the conformity of production.

3. Verification of CoP on CO₂ mass emissions/ fuel efficiency of NOVC-HEVs
 - 3.1. The vehicle shall be tested as described in paragraph 3.3. of Annex B8.
 - 3.2. During this test, the CO₂ mass emission $M_{CO_2,CS,c,6}$ of the NOVC-HEV shall be determined according to step 6 of Table A8/5 of Annex 8.
 During this test, the fuel efficiency $FE_{CS,COP}$ of the NOVC-HEV shall be determined according to step 1 of Table A8/6 of Annex 8.
 - 3.3. The conformity of production with regard to CO₂ mass emissions or fuel efficiency, as applicable, shall be verified on the basis of the values for the tested vehicle as described in paragraph 3.3.1. and applying a run-in factor as defined in paragraph 8.2.4. of this annex.
 - 3.3.1. CO₂ mass emission values for CoP / Fuel efficiency values for CoP
 In the case the interpolation method is not applied, the charge-sustaining CO₂ mass emission value according to step 7 of Table A8/5 of Annex B8 shall be used for verifying the conformity of production.
 In the case the interpolation method is applied, the charge-sustaining CO₂ mass emission value for the individual vehicle according to step 9 of Table A8/5 of Annex B8 shall be used for verifying the conformity of production.
 In the case the interpolation method is not applied, the charge-sustaining fuel efficiency value $FE_{CS,c,1}$ according to step 2 of Table A8/6 of Annex B8 shall be used for verifying the conformity of production.
 In the case the interpolation method is applied, the charge-sustaining fuel efficiency value $FE_{CS,c,ind}$ for the individual vehicle according to step 3 of Table A8/6 of Annex B8 shall be used for verifying the conformity of production.
4. Verification of CoP on electric energy consumption of PEVs
 - 4.1. The vehicle shall be tested as described in paragraph 3.4. of Annex B8. During the conformity of production verification, the break-off criterion for the Type 1 test procedure according to paragraph 3.4.4.1.3. of Annex B8 (consecutive cycle procedure) and paragraph 3.4.4.2.3. of Annex B8 (Shortened Test Procedure) shall be considered reached when having finished the first applicable WLTP test cycle.
 During this test cycle, the DC electric energy consumption from the REESS(s) $EC_{DC,first,i}$ shall be determined according to paragraph 4.3 of Annex B8 where $\Delta E_{REESS,j}$ shall be the electric energy change of all REESS and d_j shall be the actual driven distance during this test cycle.
 - 4.2. The conformity of production with regard to electric energy consumption (EC) shall be verified on the basis of the values for the tested vehicle as described in paragraph 4.2.1. in the case that the type approval was conducted with the consecutive cycle Type 1 test procedure and in paragraph 4.2.2. in case that the type approval was conducted using the shortened Type 1 test procedure.
 - 4.2.1. Consecutive cycle Type 1 test procedure values for CoP
 In the case the interpolation method is not applied, the electric energy consumption value $EC_{DC,COP,final}$ according to step 9 of Table A8/10 of Annex B8 shall be used for verifying the conformity of production.
 In the case that the interpolation method is applied, the electric energy consumption value $EC_{DC,COP,ind}$ for the individual vehicle according to step 10 of Table A8/10 of Annex B8 shall be used for verifying the conformity of production.

- 4.2.2. Shortened Type 1 Test Procedure values for CoP
- In the case the interpolation method is not applied, the electric energy consumption value $EC_{DC,COP,final}$ according to step 8 of Table A8/11 of Annex B8 shall be used for verifying the conformity of production.
- In the case the interpolation method is applied, the electric energy consumption value $EC_{DC,COP,ind}$ for the individual vehicle according to step 9 of Table A8/11 of Annex B8 shall be used for verifying the conformity of production.
5. Verification of CoP on CO₂ mass emissions / fuel efficiency of OVC-HEVs
- 5.1. At the request of the manufacturer it is allowed to use different test vehicles for the charge-sustaining test and charge-depleting test.
- 5.2. Verification of the charge-sustaining CO₂ mass emissions / fuel efficiency, as applicable, for conformity of production.
- 5.2.1. The vehicle shall be tested according to the charge-sustaining Type 1 test as described in paragraph 3.2.5. of Annex B8.
- 5.2.2. During this test, the charge-sustaining CO₂ mass emission $M_{CO_2,CS,c,6}$ shall be determined according to step 6 of Table A8/5 of Annex B8.
- During this test, the charge-sustaining fuel efficiency $FE_{CS,c,COP}$ shall be determined according to step 1 of Table A8/6 of Annex 8.
- 5.2.3. The conformity of production with regard to charge-sustaining CO₂ mass emissions shall be verified on the basis of the values for the tested vehicle as described in paragraph 5.2.3.1. for charge-sustaining CO₂ mass emissions, and applying a run-in factor as defined in paragraph 8.2.4. of this annex.
- The conformity of production with regard to charge-sustaining fuel efficiency shall be verified on the basis of the values for the tested vehicle as described in paragraph 5.2.3.1. for charge-sustaining fuel efficiency, and applying a run-in factor as defined in paragraph 8.2.4. of this annex.
- 5.2.3.1. Charge-Sustaining CO₂ mass emission / fuel efficiency values for CoP
- In the case the interpolation method is not applied, the charge-sustaining CO₂ mass emission value $M_{CO_2,CS,c,7}$ according to step 7 of Table A8/5 of Annex B8 shall be used for verifying the conformity of production.
- In the case the interpolation method is applied, the charge-sustaining CO₂ mass emission value $M_{CO_2,CS,c,ind}$ for the individual vehicle according to step 9 of Table A8/5 of Annex B8 shall be used for verifying the conformity of production.
- In the case that the interpolation method is not applied, the charge-sustaining fuel efficiency value $FE_{CS,c}$ according to step 2 of Table A8/6 of Annex B8 shall be used for verifying the conformity of production.
- In the case the interpolation method is applied, the charge-sustaining fuel efficiency value $FE_{CS,c,ind}$ for the individual vehicle according to step 3 of Table A8/6 of Annex B8 shall be used for verifying the conformity of production.
- 5.3. Verification of CoP on charge-depleting electric energy consumption of OVC-HEVs
- 5.3.1. The vehicle shall be tested during conformity of production according to paragraph 5.3.1.1. If there is no engine start during the first cycle of the type approval procedure of this vehicle, at the option of the manufacturer the vehicle may be tested according to paragraph 5.3.1.2.

5.3.1.1. Charge-Depleting Type 1 test procedure

The vehicle shall be tested according to the charge-depleting Type 1 test procedure as described in paragraph 3.2.4. of Annex B8. During this test, the electric energy consumption $EC_{AC,CD}$ shall be determined according to step 9 of Table A8/8 of Annex B8.

If deemed necessary, the manufacturer shall demonstrate that preconditioning of the traction REESS in advance of the CoP procedure is required. In such a case, at the request of the manufacturer and with approval of the approval authority, preconditioning of the traction REESS shall be done in advance of the CoP procedure according to manufacturer's recommendation.

5.3.1.2. First cycle of the Charge-Depleting Type 1 Test

5.3.1.2.1. The vehicle shall be tested according to the charge-depleting Type 1 test as described in paragraph 3.2.4. of Annex B8 while the break-off criterion of the charge-depleting Type 1 test procedure shall be considered reached when having finished the first applicable WLTP test cycle and replace the break-off criterion of the charge-depleting Type 1 test procedure according to paragraph 3.2.4.4. of Annex B8.

During this test cycle, the DC electric energy consumption from the REESS(s) $EC_{DC,first,i}$ shall be determined according to paragraph 4.3. of Annex B8 where $\Delta E_{REESS,j}$ shall be the electric energy change of all REESS and d_j shall be the actual driven distance during this test cycle.

5.3.1.2.2. In this cycle, there is no engine operation allowed. If there is engine operation, the test during conformity of production shall be considered as void.

5.3.2. The conformity of production with regard to the charge-depleting electric energy consumption shall be verified on the basis of the values for the tested vehicle as described in paragraph 5.3.2.1. in the case that the vehicle is tested according to paragraph 5.3.1.1. and as described in paragraph 5.3.2.2. in the case that the vehicle is tested according to paragraph 5.3.1.2.

5.3.2.1. Conformity of production for a test according to paragraph 5.3.1.1.

In the case that the interpolation method is not applied, the charge-depleting electric energy consumption value $EC_{AC,CD,final}$ according to step 16 of Table A8/8 of Annex B8 shall be used for verifying the conformity of production.

In the case the interpolation method is applied, the charge-depleting electric energy consumption value $EC_{AC,CD,ind}$ for the individual vehicle according to step 17 of Table A8/8 of Annex B8 shall be used for verifying the conformity of production.

5.3.2.2. Conformity of production for a test according to paragraph 5.3.1.2.

In the case the interpolation method is not applied, the charge-depleting electric energy consumption value $EC_{DC,CD,COP,final}$ according to step 16 of Table A8/8 of Annex B8 shall be used for verifying the conformity of production.

In the case the interpolation method is applied, the charge-depleting electric energy consumption value $EC_{DC,CD,COP,ind}$ for the individual vehicle according to step 17 of Table A8/8 of Annex B8 shall be used for verifying the conformity of production.

Appendix 2

Verification of conformity of production for Type 1 test - statistical method

1. This Appendix describes the procedure to be used to verify the production conformity requirements for the Type 1 test for criteria emissions, CO₂ emissions, fuel efficiency and electric energy consumption, as applicable and in accordance with Table 8/1 of this Regulation, for pure ICE, NOVC-HEV, PEV and OVC-HEV and, where applicable, to determine the OBFCM device accuracy.

Measurements of the criteria emissions, CO₂ emissions, fuel efficiency and electric energy consumption, as applicable and in accordance with Table 8/1 of this Regulation, shall be carried out on a minimum number of 3 vehicles, and consecutively increase until a pass or fail decision is reached. Where applicable, the OBFCM device accuracy shall be determined for each of the N tests.

2. Criteria emissions
 - 2.1 Statistical procedure and pass/fail criteria
 - 2.1.1. For the criteria emissions from the 4 phases of a WLTP test:

For the total number of N tests and the measurement results of the tested vehicles, x_1, x_2, \dots, x_N , the average X_{tests} and the variance VAR shall be determined:

$$X_{tests} = \frac{(x_1 + x_2 + x_3 + \dots + x_N)}{N}$$

and

$$VAR = \frac{(x_1 - X_{tests})^2 + (x_2 - X_{tests})^2 + \dots + (x_N - X_{tests})^2}{N - 1}$$

For OVC-HEV, in case of complete charge-depleting Type 1 test, the average emissions over the complete test of an individual vehicle shall be considered as a single value x_i .

For each number of tests, one of the three following decisions can be reached for criteria emissions, based on the criteria emission limit value L according to Table 1A in paragraph 6.3.10. of this Regulation:

- (i) Pass the family if $X_{tests} < A \cdot L - \frac{VAR}{L}$
- (ii) Fail the family if $X_{tests} > A \cdot L - \left(\frac{N-3}{13} \cdot \frac{VAR}{L}\right)$
- (iii) Take another measurement if:

$$A \cdot L - \frac{VAR}{L} \leq X_{tests} \leq A \cdot L - \left(\frac{N-3}{13} \cdot \frac{VAR}{L}\right)$$

For the measurement of criteria emissions the factor A is set at 1.05.

- 2.1.2. For criteria emissions from the first 3 phases of a WLTP test::

Case A: the manufacturer's production standard deviation is satisfactory.

With a minimum sample size of 3, the sampling procedure is set so that the probability of a lot passing a test with 40 per cent of the production defective is 0.95 (producer's risk = 5 per cent) while the probability of a lot being accepted with 65 per cent of the production defective is 0.1 (consumer's risk = 10 per cent).

For each of the criteria emissions given in Table 1B of paragraph 6.3.10. of this Regulation, the following procedure is used (see Figure 8/1 in paragraph 8.2.3.1. of this Regulation) where:

L = the natural logarithm of the limit value for the criteria emission,

x_i = the natural logarithm of the measurement for the i -th vehicle of the sample,

s = an estimate of the production standard deviation (after taking the natural logarithm of the measurements),

n = the current sample number.

Compute for the sample the test statistic quantifying the sum of the standard deviations from the limit and defined as:

$$\frac{1}{s} \sum_{i=1}^n (L - x_i)$$

If the test statistic is greater than the pass decision number for the sample size given in Table A2/1, the criteria emission is passed;

If the test statistic is less than the fail decision number for the sample size given in Table A8/3, the pollutant is failed; otherwise, an additional vehicle is tested and the calculation reapplied to the sample with a sample size one unit greater.

Table A2/1

Pass/fail decision number for the sample size

<i>Cumulative number of tested vehicles (current sample size)</i>	<i>Pass decision threshold</i>	<i>Fail decision threshold</i>
3	3.327	-4.724
4	3.261	-4.79
5	3.195	-4.856
6	3.129	-4.922
7	3.063	-4.988
8	2.997	-5.054
9	2.931	-5.12
10	2.865	-5.185
11	2.799	-5.251
12	2.733	-5.317
13	2.667	-5.383
14	2.601	-5.449
15	2.535	-5.515
16	2.469	-5.581
17	2.403	-5.647
18	2.337	-5.713
19	2.271	-5.779
20	2.205	-5.845
21	2.139	-5.911
22	2.073	-5.977
23	2.007	-6.043
24	1.941	-6.109
25	1.875	-6.175
26	1.809	-6.241
27	1.743	-6.307
28	1.677	-6.373
29	1.611	-6.439
30	1.545	-6.505
31	1.479	-6.571
32	-2.112	-2.112

Case B: the manufacturer's evidence of production standard deviation is either not satisfactory or not available.

With a minimum sample size of 3, the sampling procedure is set so that the probability of a lot passing a test with 40 per cent of the production defective is 0.95 (producer's risk = 5 per cent) while the probability of a lot being accepted with 65 per cent of the production defective is 0.1 (consumer's risk = 10 per cent).

The measurements of the criteria emissions given in Table 1B of paragraph 6.3.10. of this Regulation are considered to be log normally distributed and shall first be transformed by taking their natural logarithms. Let m_0 and m denote the minimum and maximum sample sizes respectively ($m_0 = 3$ and $m = 32$) and let n denote the current sample number.

If the natural logarithms of the measurements in the series are x_1, x_2, \dots, x_n and L is the natural logarithm of the limit value for the pollutant, then define:

$$d_i = x_i - L$$

$$\bar{d}_n = \frac{1}{n} \sum_{i=1}^n d_i$$

and

$$V_n^2 = \frac{1}{n} \sum_{i=1}^n (d_i - \bar{d}_n)^2$$

Table A2/2

Minimum sample size = 3

<i>Sample size (n)</i>	<i>Pass decision threshold (A_n)</i>	<i>Fail decision threshold (B_n)</i>
3	-0.80381	16.64743
4	-0.76339	7.68627
5	-0.72982	4.67136
6	-0.69962	3.25573
7	-0.67129	2.45431
8	-0.64406	1.94369
9	-0.61750	1.59105
10	-0.59135	1.33295
11	-0.56542	1.13566
12	-0.53960	0.97970
13	-0.51379	0.85307
14	-0.48791	0.74801
15	-0.46191	0.65928
16	-0.43573	0.58321
17	-0.40933	0.51718
18	-0.38266	0.45922
19	-0.35570	0.40788
20	-0.32840	0.36203
21	-0.30072	0.32078
22	-0.27263	0.28343
23	-0.24410	0.24943
24	-0.21509	0.21831
25	-0.18557	0.18970
26	-0.15550	0.16328
27	-0.12483	0.13880
28	-0.09354	0.11603
29	-0.06159	0.09480
30	-0.02892	0.07493
31	0.00449	0.05629
32	0.03876	0.03876

Table A2/2 shows values of the pass (A_n) and fail (B_n) decision numbers against current sample number. The test statistic is the ratio \bar{d}_n/V_n and shall be used to determine whether the series has passed or failed as follows:

For $m_0 \leq n \leq m$:

(i) Pass the series if $\frac{\bar{d}_n}{V_n} \leq A_n$

(ii) Fail the series if $\frac{\bar{d}_n}{V_n} \geq B_n$

(iii) Take another measurement if $A_n < \frac{\bar{d}_n}{V_n} < B_n$

Remarks:

The following recursive formulae are useful for computing successive values of the test statistic:

$$\bar{d}_n = \left(1 - \frac{1}{n}\right)\bar{d}_{n-1} + \frac{1}{n}d_n$$

$$V_n^2 = \left(1 - \frac{1}{n}\right)V_{n-1}^2 + \left[\frac{\bar{d}_n - d_n}{n-1}\right]^2$$

$$(n = 2, 3, \dots ; \quad \bar{d}_1 = d_1; \quad V_1 = 0)$$

- 2.1.3. A pass is reached only if a pass decision has been reached both for the requirements of paragraph 2.1.1. and 2.1.2.

If a pass decision has been reached only for the requirements in paragraph 2.1.1., the testing and statistical evaluation shall only continue for the requirements in paragraph 2.1.2. until a pass decision has been reached.

If a pass decision has been reached only for the requirements in paragraph 2.1.2., the testing and statistical evaluation shall only continue for the requirements in paragraph 2.1.1. until a pass decision has been reached.

3. CO₂ emissions, fuel efficiency and electric energy consumption

- 3.1. Statistical procedure

- 3.1.1. For the CO₂ emissions and electric energy consumption from the 4 phases of a WLTP test:

For the total number of N tests and the measurement results of the tested vehicles, x_1, x_2, \dots, x_N , the average X_{tests} and the standard deviation s shall be determined:

$$X_{tests} = \frac{(x_1 + x_2 + x_3 + \dots + x_N)}{N}$$

and

$$s = \sqrt{\frac{(x_1 - X_{tests})^2 + (x_2 - X_{tests})^2 + \dots + (x_N - X_{tests})^2}{N - 1}}$$

- 3.1.2. For fuel efficiency and electric energy consumption from the first 3 phases of a WLTP test:

For the total number of N tests and the measurement results of the tested vehicles, x_1, x_2, \dots, x_N , the average X_{tests} and the standard deviation σ shall be determined:

$$X_{tests} = \frac{(x_1 + x_2 + x_3 + \dots + x_N)}{N}$$

and

$$\sigma = \sqrt{\frac{(x_1 - X_{tests})^2 + (x_2 - X_{tests})^2 + \dots + (x_N - X_{tests})^2}{N}}$$

3.2. Statistical evaluation

3.2.1. For the CO₂ emissions and electric energy consumption from the 4 phases of a WLTP test:

For the evaluation of CO₂ emissions the normalised values shall be calculated as follows:

$$x_i = \frac{CO_{2\ test-i}}{CO_{2\ declared-i}}$$

where:

$CO_{2\ test-i}$ is the CO₂ emission measured for individual vehicle i

$CO_{2\ declared-i}$ is the declared CO₂ value for the individual vehicle

For the evaluation of electric energy consumption EC the normalised values shall be calculated as follows:

$$x_i = \frac{EC_{test-i}}{EC_{DC,COP-i}}$$

where:

EC_{test-i} is the electric energy consumption measured for individual vehicle i. In the case that the complete charge-depleting Type 1 test has been applied, EC_{test-i} shall be determined according to paragraph 5.3.1.1. of Appendix 1. In the case that only the first cycle is tested for verification of CoP, EC_{test-i} shall be determined according to paragraph 5.3.1.2. of Appendix 1.

$EC_{DC,COP-i}$ is the declared electric energy consumption for the individual vehicle i, according to Appendix 8 to Annex B8. In the case that the complete charge-depleting Type 1 test has been applied, $EC_{DC,COP,i}$ shall be determined according to paragraph 5.3.2.1. of Appendix 1. In the case that only the first cycle is tested for verification of CoP, $EC_{COP,i}$ shall be determined according to paragraph 5.3.2.2 of Appendix 1.

The normalised x_i values shall be used to determine the parameters X_{tests} and s according to paragraph 3.1.

3.2.2. For fuel efficiency and electric energy consumption from the first 3 phases of a WLTP test:

For the evaluation of fuel efficiency the normalised values shall be calculated as follows:

$$x_i = \frac{FE_{test-i}}{FE_{declared-i}}$$

where:

FE_{test-i} is the fuel efficiency measured for individual vehicle i

$FE_{declared-i}$ is the declared fuel efficiency value for the individual vehicle

For the evaluation of electric energy consumption EC the normalised values shall be calculated as follows:

$$x_i = \frac{EC_{test-i}}{EC_{DC,COP-i}}$$

where:

EC_{test-i} is the electric energy consumption measured for individual vehicle i. In the case that the complete charge-depleting Type 1 test has been applied, EC_{test-i} shall be determined according to paragraph 5.3.1.1. of Appendix 1. In the case that only the first cycle is tested for verification of CoP, EC_{test-i} shall be determined according to paragraph 5.3.1.2. of Appendix 1.

$EC_{DC, COP-i}$ is the declared electric energy consumption for the individual vehicle i , according to Appendix 8 to Annex B8. In the case that the complete charge-depleting Type 1 test has been applied, $EC_{DC, COP-i}$ shall be determined according to paragraph 5.3.2.1. of Appendix 1. In the case that only the first cycle is tested for verification of CoP, EC_{COP-i} shall be determined according to paragraph 5.3.2.2. of Appendix 1.

The normalised x_i values shall be used to determine the parameters X_{tests} and s according to paragraph 3.1.

3.3. Pass/fail criteria

3.3.1. For the CO₂ emissions and electric energy consumption from the 4 phases of a WLTP test

For each number of tests, one of the three following decisions can be reached, where the factor A shall be set at 1.01:

(i) Pass the family if $X_{tests} \leq A - (t_{P1,i} + t_{P2,i}) \cdot s$

(ii) Fail the family if $X_{tests} > A + (t_{F1,i} - t_{F2}) \cdot s$

(iii) Take another measurement if:

$$A - (t_{P1,i} + t_{P2,i}) \cdot s < X_{tests} \leq A + (t_{F1,i} - t_{F2}) \cdot s$$

where:

parameters $t_{P1,i}$, $t_{P2,i}$, $t_{F1,i}$, and t_{F2} are taken from the Table A2/3.

Table A2/3

Pass/fail decision number for the sample size

Tests (i)	PASS		FAIL	
	$t_{P1,i}$	$t_{P2,i}$	$t_{F1,i}$	t_{F2}
3	1.686	0.438	1.686	0.438
4	1.125	0.425	1.177	0.438
5	0.850	0.401	0.953	0.438
6	0.673	0.370	0.823	0.438
7	0.544	0.335	0.734	0.438
8	0.443	0.299	0.670	0.438
9	0.361	0.263	0.620	0.438
10	0.292	0.226	0.580	0.438
11	0.232	0.190	0.546	0.438
12	0.178	0.153	0.518	0.438
13	0.129	0.116	0.494	0.438
14	0.083	0.078	0.473	0.438
15	0.040	0.038	0.455	0.438
16	0.000	0.000	0.438	0.438

3.3.2. For fuel efficiency and electric energy consumption from the first 3 phases of a WLTP test

3.3.2.1. For the evaluation of FE (Fuel Efficiency in km/L) the following provisions apply:

- (a) If $3 \leq N_{\text{Evaluation}} \leq 10$
 (i) Pass the family if $X_{\text{tests}N_{\text{Evaluation}}} \geq 1.000$
 (ii) Take another measurement if $X_{\text{tests}N_{\text{Evaluation}}} < 1.000$
 (b) If $N = 11$
 (i) Pass the family if all the following decisions can be reached

i. $X_{\text{tests}N_{\text{Evaluation}}} \geq 1.000 - \frac{3 * \sigma}{\sqrt{N_{\text{Evaluation}}}}$

ii. $X_{\text{tests}N_{\text{CoP family}}} \geq 1.000 - \frac{3 * \sigma}{\sqrt{N_{\text{CoP family}}}}$

iii. $x_i \geq 1.000 - 3 * \sigma$

- (ii) Fail the family if one of the following decisions can be reached

i. $X_{\text{tests}N_{\text{Evaluation}}} < 1.000 - \frac{3 * \sigma}{\sqrt{N_{\text{Evaluation}}}}$

ii. $X_{\text{tests}N_{\text{CoP family}}} < 1.000 - \frac{3 * \sigma}{\sqrt{N_{\text{CoP family}}}}$

iii. $x_i < 1.000 - 3 * \sigma$

where:

$N_{\text{Evaluation}}$ is the total number of vehicle tested during the applicable evaluation

$N_{\text{CoP family}}$ is the total number of vehicle tested in the CoP family during the year

(e.g. If the vehicle tested for the first evaluation is 11 and the vehicle tested for the second evaluation is 4, $N_{\text{Evaluation}}=4$ and $N_{\text{CoP family}}=15$)

In any case, if $N_{\text{CoP family}} > 10$, $x_i \geq 1.000 - 3 * \sigma$ shall be satisfied.

3.3.2.2. For the evaluation of EC (Electric consumption in Wh/km) the following provisions apply:

- (a) If $3 \leq N_{\text{Evaluation}} \leq 10$
 (i) Pass the family if $X_{\text{tests}N_{\text{Evaluation}}} \leq 1.000$
 (ii) Take another measurement if $X_{\text{tests}N_{\text{Evaluation}}} > 1.000$
 (b) If $N = 11$
 (i) Pass the family if all the following decisions can be reached

i. $X_{\text{tests}N_{\text{Evaluation}}} \leq 1.000 + \frac{3 * \sigma}{\sqrt{N_{\text{Evaluation}}}}$

ii. $X_{\text{tests}N_{\text{CoP family}}} \leq 1.000 + \frac{3 * \sigma}{\sqrt{N_{\text{CoP family}}}}$

iii. $x_i \leq 1.000 + 3 * \sigma$

- (ii) Fail the family if one of the following decisions can be reached

i. $X_{\text{tests}N_{\text{Evaluation}}} > 1.000 + \frac{3 * \sigma}{\sqrt{N_{\text{Evaluation}}}}$

ii. $X_{\text{tests}N_{\text{CoP family}}} > 1.000 + \frac{3 * \sigma}{\sqrt{N_{\text{CoP family}}}}$

iii. $x_i > 1.000 + 3 * \sigma$

where:

$N_{\text{Evaluation}}$ is the total number of vehicle tested during the applicable evaluation

$N_{\text{CoP family}}$ is the total number of vehicle tested in the CoP family during the year

(e.g. If the vehicle tested for the first evaluation is 11 and the vehicle tested for the second evaluation is 4, $N_{\text{Evaluation}}=4$ and $N_{\text{CoP family}}=15$)

In any case, if $N_{\text{CoP family}} > 10$, $x_i \leq 1.000 + 3 * \sigma$ shall be satisfied.

- 3.3.2.3. If the number of vehicles produced within the CoP family exceeds 7,500 vehicles per 12 months, for the second or later evaluation, “a. If $3 \leq N_{\text{Evaluation}} \leq 10$ ” may be replaced by “a. If $N_{\text{Evaluation}} = 3$ ” and “b. If $N_{\text{Evaluation}} = 11$ ” may be replaced by “b. If $N_{\text{Evaluation}} = 4$ ”. For the second or later year, this provision shall not be used for the first evaluation for the CoP family in the year.

σ shall be determined from the test result of first 10 tested vehicles after start of production for each CoP family. σ shall not be changed once σ is determined for the CoP family even for the second or later years. At the request of the manufacturer and with the approval of the responsible authority, and with reasonable evidence and appropriate data, σ may be changed.

- 3.3.3. A pass is reached only if a pass decision has been reached both for the requirements of paragraph 3.3.1. and 3.3.2.

If a pass decision has been reached only for the requirements in paragraph 3.3.1., the testing and statistical evaluation shall only continue for the requirements in paragraph 3.3.2. until a pass decision has been reached.

If a pass decision has been reached only for the requirements in paragraph 3.3.2., the testing and statistical evaluation shall only continue for the requirements in paragraph 3.3.1. until a pass decision has been reached.

- 3.4. For vehicles referred to in paragraph 5.11. of this Regulation the accuracy $x_{i,OBFCM}$ of the OBFCM device shall be determined for each single test i in accordance with the formulae in paragraph 4.2. of Appendix 5.

The Type Approval authority shall keep a record of the determined accuracies for each CoP family tested.

Appendix 3

Run-in test procedure to determine run-in factors

1. Description of test procedure for the determination of the run-in factors

Prior to the application of the derived run-in factor, the manufacturer shall provide the following information to the responsible authority.

 - (a) evidence of the derived “run-in” factor including the existence of statistical significance regarding the fit of the slope
 - (b) validation method after the start of production by measuring the run-in factor from selected vehicle(s) from the plant and then evaluating whether the run-in factor is appropriate or not.
- 1.1. The run-in test procedure shall be conducted by the manufacturer, who shall not make any adjustments to the test vehicles that have an impact on the criteria emissions, CO₂ emissions, fuel efficiency and electric energy consumption. The hardware and ECU calibration of the test vehicle shall conform to the type approval vehicle. All the relevant hardware that has an impact on the criteria emissions, CO₂ emissions, fuel efficiency and electric energy consumption shall have had no operation prior to the run-in test procedure.
- 1.2. The test vehicle shall be configured as vehicle H within the CoP family.

If the CoP family has multiple interpolation families, the test vehicle shall be configured as vehicle H of the interpolation family with the highest expected production volume within the CoP family. At the request of the manufacturer, and with approval of the responsible authority a different test vehicle may be selected.
- 1.3. The test vehicle shall be a new vehicle, or a used test vehicle for which at least all of the following components are newly installed simultaneously:
 - internal combustion engine;
 - driveline components (at least, but not limited to, transmission, tyre, axles, etc.);
 - brake components;
 - REESSs for EVs;
 - exhaust system.

and any other component that has a non-negligible influence on criteria emissions, CO₂ emissions, fuel efficiency and electric energy consumption. For the new vehicle, or the used vehicle for which the above mentioned components have been replaced, the system odometer of the test vehicle D_s in km shall recorded.
- 1.4. At the request of the manufacturer and with approval by the responsible authority, it is allowed to perform the run-in procedure on multiple test vehicles. In this case, the valid test results of all tested vehicles shall be considered for the determination of the run-in factors.
- 1.5. Chassis dynamometer setting
 - 1.5.1. The chassis dynamometer shall be set to the target road load for the test vehicle, according to the procedure specified in paragraph 7. of Annex B4.

The chassis dynamometer shall be set independently prior to each test before the run-in mileage accumulation and shall be set once for the post-run-in tests after the run-in mileage accumulation.
- 1.6. Before the run-in, the test vehicle shall be tested according to the Type 1 test procedure specified in Annex B6 and Annex B8. The test shall be repeated until three valid test results have been obtained. Drive trace indexes shall be calculated according to paragraph 7. of Annex B7 and these shall fulfil the

specified criteria in paragraph 2.6.8.3.1.4. of Annex B6. The system odometer setting D_i shall be recorded prior to each test. The measured criteria emissions, CO₂ emissions, fuel efficiency and electric energy consumption shall be calculated according to Step 4a of Table A7/1 in Annex B7 or Step 4a of Table A8/5 in Annex B8.

The signal of the acceleration control position shall be recorded during all tests at a sampling frequency of 10 Hz. It is allowed to use the OBD acceleration control position signal for this purpose. The responsible authority may request the manufacturer to evaluate this signal to ensure that the test result is performed correctly.

- 1.7. After the initial tests, the test vehicle shall be run-in under normal driving conditions. OVC-HEVs shall be driven predominantly in charge-sustaining operating conditions. The driving pattern, test conditions and fuel during the run-in shall be in accordance with the manufacturer's engineering judgement. The run-in distance shall be less than or equivalent to the distance driven during the run-in of the vehicle which was tested for the type approval of the interpolation family, in accordance with paragraph 2.3.3. of Annex B6 or paragraph 2. of Annex B8.

- 1.8. After the run-in, the test vehicle shall be tested according to the Type 1 test procedure specified in Annex B6 and Annex B8. The test shall be repeated until three valid test results have been obtained.

Drive trace indexes shall be calculated according to paragraph 7. of Annex B7 and these shall fulfil the specified criteria in paragraph 2.6.8.3.1.4. of Annex B6.

These tests shall be performed in the same test cell as used for the tests prior to the run-in and by applying the same chassis dynamometer setting method. If this is not possible, the manufacturer shall justify the reason for using a different test cell. The system odometer setting D_i in km shall be recorded prior to each test. The measured criteria emissions, CO₂ emissions, fuel efficiency and electric energy consumption, as applicable and in accordance with paragraph 8.2.4.1., shall be calculated according to Step 4a of Table A7/1 in Annex B7 or Step 4a of Table A8/5 in Annex B8.

- 1.9. For the determination of the run-in factor for the CO₂ emissions, the coefficients C_{RI} and C_{const} in the following equation shall be calculated by a least squares regression analysis to four significant digits on all valid tests before and after the run-in:

$$M_{CO_2,i} = -C_{RI} \cdot \ln(D_i - D_s) + C_{const}$$

where:

$M_{CO_2,i}$ is the measured CO₂ mass emission for test i , g/km

C_{RI} is the slope of the logarithmic regression line

C_{const} is the constant value of the logarithmic regression line

In the case that multiple vehicles have been tested, the C_{RI} shall be calculated for each vehicle, and the resulting values shall be averaged. The manufacturer will provide statistical evidence to the responsible authority that the fit is sufficiently statistically justified.

[Based on the deviation of the measurements from the fit, the slope C_{RI} should be corrected downward with the standard deviation of the errors in the fit:

$$\sigma_{fit} = \sqrt{\frac{\sum(M_{CO_2,i} - M_{CO_2,i-fit})^2}{N-2}}$$

where:

$M_{CO_2,i-fit}$ is the result of the applying the equation for each of the distances D_i .

The slope C_{RI} shall be corrected for the uncertainty in the fit by:

$$C_{RI} \rightarrow C_{RI} - \sigma_{fit}]$$

- 1.10. The run-in factor $RI_{CO_2}(j)$ for CO₂ emissions of CoP test vehicle j shall be determined by the following equation:

$$RI_{CO_2}(j) = 1 - C_{RI} \cdot \left(\frac{\ln(D_k) - \ln(D_j)}{M_{CO_2,j}} \right)$$

where:

D_k is the average distance of the valid tests after the run-in, km

D_j is the system odometer setting of the CoP test vehicle, km

$M_{CO_2,j}$ is the mass CO₂ emission measured on the CoP test vehicle, g/km

In the case that D_j is lower than the minimum D_i , D_j shall be replaced by the minimum D_i .

- 1.11. For the determination of the run-in factor for all applicable criteria emissions, the coefficients $C_{RI,c}$ and $C_{const,c}$ shall be calculated with a least squares regression analysis to four significant digits on all valid tests before and after the run-in:

$$M_{C,i} = C_{RI,c} \cdot (D_i - D_s) + C_{const,c}$$

where:

$M_{C,i}$ is the measured mass criteria emission component C

$C_{RI,c}$ is the slope of the linear regression line, g/km²

$C_{const,c}$ is the constant value of the linear regression line, g/km

The manufacturer will provide statistical evidence to the responsible authority that the fit is sufficiently statistically justified and the uncertainty margin based on the variation in the data should be taken into account to avoid an overestimation of the run-in effect.

- 1.12. The run-in factor $RI_C(j)$ for criteria emission component C of CoP test vehicle j shall be determined by the following equation:

$$RI_C(j) = 1 + C_{RI,c} \cdot \left(\frac{D_k - D_j}{M_{C,j}} \right)$$

where:

D_k is the average distance of the valid tests after the run-in, km

D_j is the system odometer setting of the CoP test vehicle, km

$M_{C,j}$ is the mass emission of component C on the CoP test vehicle, g/km

In the case that D_j is lower than the minimum D_i , D_j shall be replaced by the minimum D_i .

- 1.13. The run-in factor $RI_{EC}(j)$ for electric energy consumption shall be determined according to the procedure specified in paragraphs 1.9. and 1.10. of this appendix, where CO₂ in the formulae is replaced by EC.

For fuel efficiency from the first 3 phases of a WLTP test

The run-in factor $RI_{FE}(j)$ for fuel efficiency shall be determined according to the procedure specified in paragraphs 1.9. and 1.10. of this appendix, where CO₂ in the formulae is replaced by FE.

Appendix 4

Conformity of production for Type 4 test

1. For routine end-of-production-line testing, the holder of the approval may demonstrate compliance by sampling vehicles which shall meet the requirements in paragraphs 2 to 4.
 - 1.1. In case of vehicles with a sealed fuel tank system, at the request of the manufacturer and in agreement with the responsible authority, alternative procedures to paragraphs 2. to 4. of this appendix can be applied.
 - 1.2. When the manufacturer chooses to use any alternative procedure, all the details of the conformity test procedure shall be recorded in the type approval documentation.
2. Test for leakage
 - 2.1. Vents to the atmosphere from the emission control system shall be isolated.
 - 2.2. A pressure of $3.70 \text{ kPa} \pm 0.10 \text{ kPa}$ shall be applied to the fuel system. At the request of manufacturer and with approval of the responsible authority, an alternative pressure can also be applied, taking into account the pressure range in use of the fuel system.
 - 2.3. The pressure shall be allowed to stabilise prior to isolating the fuel system from the pressure source.
 - 2.4. Following isolation of the fuel system, the pressure shall not drop by more than 0.50 kPa in five minutes.
 - 2.5. At the request of the manufacturer and in agreement with the responsible authority the function for leakage can be demonstrated by an equivalent alternative procedure.
3. Test for venting
 - 3.1. Vents to the atmosphere from the emission control shall be isolated.
 - 3.2. A pressure of $3.70 \text{ kPa} \pm 0.10 \text{ kPa}$ shall be applied to the fuel system. At the request of manufacturer and with approval of the responsible authority, an alternative pressure can also be applied, taking into account the pressure range in use of the fuel system.
 - 3.3. The pressure shall be allowed to stabilise prior to isolating the fuel system from the pressure source.
 - 3.4. The venting outlets from the emission control systems to the atmosphere shall be reinstated to the production condition.
 - 3.5. The pressure of the fuel system shall drop to below a pressure less than 2.5 kPa above ambient pressure within one minute.
 - 3.6. At the request of the manufacturer and in agreement with the responsible authority the functional capacity for venting can be demonstrated, when applicable, by an equivalent alternative procedure.
4. Purge test
 - 4.1. Equipment capable of detecting an airflow rate of 1.0 litres in one minute shall be attached to the purge inlet and a pressure vessel of sufficient size to have negligible effect on the purge system shall be connected via a switching valve to the purge inlet, or alternatively.
 - 4.2. The manufacturer may use a flow meter of his own choosing, if acceptable to the responsible authority.

- 4.3. The vehicle shall be operated in such a manner that any design feature of the purge system that could restrict purge operation is detected and the circumstances noted.
- 4.4. Whilst the engine is operating within the bounds noted in paragraph 4.3. of this appendix, the air flow shall be determined by either:
 - 4.4.1. The device indicated in paragraph 4.1. of this appendix being switched in. A pressure drop from atmospheric to a level indicating that a volume of 1.0 litre of air has flowed into the evaporative emission control system within one minute shall be observed; or
 - 4.4.2. If an alternative flow measuring device is used, a reading of no less than 1.0 litre per minute shall be detectable.
 - 4.4.3. At the request of the manufacturer and in agreement with the responsible authority an equivalent alternative purge test procedure can be used.

Appendix 5

Devices for monitoring on board the vehicle the consumption of fuel and/or electric energy

1. Introduction

This appendix sets out the definitions and requirements applicable to the devices for monitoring on board the vehicle the consumption of fuel and/or electric energy.
2. Definitions
 - 2.1. "*On-board Fuel and/or Energy Consumption Monitoring Device*" ("OBFCM device") means any element of design, either software and/or hardware, which senses and uses vehicle, engine, fuel and/or electric energy parameters to determine and make available at least the information laid down in paragraph 3 of this appendix, and store the lifetime values on board the vehicle.
 - 2.2. "*Lifetime*" value of a certain quantity determined and stored at a time t shall be the values of this quantity accumulated since the completion of production of the vehicle until time t .
 - 2.3. "*Engine fuel rate*" means the amount of fuel injected into the engine per unit of time. It does not include fuel injected directly into the pollution control device.
 - 2.4. "*Vehicle fuel rate*" means the amount of fuel injected into the engine and directly into the pollution control device per unit of time. It does not include the fuel used by a fuel operated heater.
 - 2.5. "*Total Fuel Consumed (lifetime)*" means the accumulation of the calculated amount of fuel injected into the engine and the calculated amount of fuel injected directly into the pollution control device. It does not include the fuel used by a fuel operated heater.
 - 2.6. "*Total Distance Travelled (lifetime)*" means the accumulation of the distance travelled using the same data source that the vehicle odometer uses.
 - 2.7. "*Grid energy*" means, for OVC-HEVs, the electric energy flowing into the battery when the vehicle is connected to an external power supply and the engine is turned off. It shall not include electrical losses between the external power source and the battery.
 - 2.8. "*Charge sustaining operation*" means, for OVC-HEVs, the state of vehicle operation when the REESS state of charge (SOC) may fluctuate but the intent of the vehicle control system is to maintain, on average, the current state of charge.
 - 2.9. "*Charge depleting operation*" means, for OVC-HEVs, the state of vehicle operation when the current REESS SOC is higher than the charge sustaining target SOC value and, while it may fluctuate, the intent of the vehicle control system is to deplete the SOC from a higher level down to the charge sustaining target SOC value.
 - 2.10. "*Driver-selectable charge increasing operation*" means, for OVC-HEVs, the operating condition in which the driver has selected a mode of operation, with the intention to increase the REESS SOC.
3. Information to be determined, stored and made available

The OBFCM device shall determine at least the following parameters and store the lifetime values on board the vehicle. The parameters shall be calculated and scaled according the standards referred to in paragraph 6.5.3.2 (a) of Appendix 1 to Annex C5.

The information listed in paragraph 3.1. and 3.2. shall be made available as signals through the serial port connector referred to in paragraph 6.5.3.2 (c). of Appendix 1 to Annex C5.

- 3.1. For all vehicles referred to in paragraph 5.11. of this Regulation, with the exception of OVC-HEVs:
- (a) Total fuel consumed (lifetime) (litres);
 - (b) total distance travelled (lifetime) (kilometres);
 - (c) engine fuel rate (grams/second);
 - (d) engine fuel rate (litres/hour);
 - (e) vehicle fuel rate (grams/second);
 - (f) vehicle speed (kilometres/hour).
- 3.2. For OVC-HEVs:
- (a) Total fuel consumed (lifetime) (litres);
 - (b) total fuel consumed in charge depleting operation (lifetime) (litres);
 - (c) total fuel consumed in driver-selectable charge increasing operation (lifetime) (litres);
 - (d) total distance travelled (lifetime) (kilometres);
 - (e) total distance travelled in charge depleting operation with engine off (lifetime) (kilometres);
 - (f) total distance travelled in charge depleting operation with engine running (lifetime) (kilometres);
 - (g) total distance travelled in driver-selectable charge increasing operation (lifetime) (kilometres);
 - (h) engine fuel rate (grams/second);
 - (i) engine fuel rate (litres/hour);
 - (j) vehicle fuel rate (grams/second);
 - (k) vehicle speed (kilometres/hour);
 - (l) total grid energy into the battery (lifetime) (kWh).
4. Accuracy
- 4.1. With regard to the information specified in paragraph 3, the manufacturer shall ensure that the OBFCM device provides the most accurate values that can be achieved by the measurement and calculation system of the engine control unit.
- 4.2. Notwithstanding paragraph 4.1, the manufacturer shall ensure that the accuracy is higher than – 0.05 and lower than 0.05 calculated with three decimals using the following formula:

$$\text{Accuracy} = \frac{\text{Fuel_Consumed}_{\text{WLTP}} - \text{Fuel_Consumed}_{\text{OBFCM}}}{\text{Fuel_Consumed}_{\text{WLTP}}}$$

Where:

Fuel_Consumed_{WLTP} (litres) is the fuel consumption determined at the first test carried out in accordance with paragraph 1.2 of Annex B6, calculated in accordance with paragraph 6 of Annex B7, using emission results over the total cycle before applying corrections (output of step 2 in Table A7/1 of Annex B7), multiplied by the actual distance driven and divided by 100.

Fuel_Consumed_{OBFCM} (litres) is the fuel consumption determined for the same test using the differentials of the parameter 'Total fuel consumed (lifetime)' as provided by the OBFCM device.

For OVC-HEVs the charge-sustaining Type 1 test shall be used.

- 4.2.1. If the accuracy requirements set out in paragraph 4.2. are not met, the accuracy shall be recalculated for subsequent Type 1 tests performed in accordance with paragraph 1.2 of Annex B6, in accordance with the formulae in paragraph 4.2, using the fuel consumed determined and accumulated over all performed tests. The accuracy requirement shall be deemed to be fulfilled once the accuracy is higher than -0.05 and lower than 0.05 .
- 4.2.2. If the accuracy requirements set out in paragraph 4.2.1. are not met following the subsequent tests pursuant to this point, additional tests may be performed for the purpose of determining the accuracy, however, the total number of tests shall not exceed three tests for a vehicle tested without using the interpolation method (vehicle H), and six tests for a vehicle tested using the interpolation method (three tests for vehicle H and three tests for vehicle L). The accuracy shall be recalculated for the additional subsequent Type 1 tests in accordance with the formulae in paragraph 4.2., using the fuel consumed determined and accumulated over all performed tests. The requirement shall be deemed to be fulfilled once the accuracy is higher than -0.05 and lower than 0.05 . Where the tests have been performed only for the purpose of determining the accuracy of the OBFCM device, the results of the additional tests shall not be taken into account for any other purposes.
5. Access to the information provided by the OBFCM device
 - 5.1. The OBFCM device shall provide for standardised and unrestricted access of the information specified in paragraph 3. and shall conform to the standards referred to in paragraphs 6.5.3.1. (a) and 6.5.3.2. (a) of Appendix 1 to Annex C5.
 - 5.2. By way of exemption from the reset conditions specified in the standards referred to in paragraph 5.1 and notwithstanding paragraphs 5.3. and 5.4., once the vehicle has entered into service the values of the lifetime counters shall be preserved.
 - 5.3. The values of the lifetime counters may be reset only for those vehicles for which the memory type of the engine control unit is unable to preserve data when not powered by electricity. For those vehicles the values may be reset simultaneously only in the case the battery is disconnected from the vehicle. The obligation to preserve the values of the lifetime counters shall in this case apply for new type approvals at the latest from 1 January 2022 and for new vehicles from 1 January 2023.
 - 5.4. In the case of malfunctioning affecting the values of the lifetime counters, or replacement of the engine control unit, the counters may be reset simultaneously to ensure that the values remain fully synchronised.

Appendix 6

Requirements for vehicles that use a reagent for the exhaust after-treatment system

1. This appendix sets out the requirements for vehicles that rely on the use of a reagent for the after-treatment system in order to reduce emissions. Every reference in this appendix to 'reagent tank' shall be understood as also applying to other containers in which a reagent is stored.
 - 1.1. The capacity of the reagent tank shall be such that a full reagent tank does not need to be replenished over an average driving range of 5 full fuel tanks providing the reagent tank can be easily replenished (e.g. without the use of tools and without removing vehicle interior trim. The opening of an interior flap, in order to gain access for the purpose of reagent replenishment, shall not be understood as the removal of interior trim). If the reagent tank is not considered to be easy to replenish as described above, the minimum reagent tank capacity shall be at least equivalent to an average driving distance of 15 full fuel tanks. However, in the case of the option in paragraph 3.5., where the manufacturer chooses to start the warning system at a distance which may not be less than 2,400 km before the reagent tank becomes empty, the above restrictions on a minimum reagent tank capacity shall not apply.
 - 1.2. In the context of this appendix, the term "average driving distance" shall be taken to be derived from the fuel or reagent consumption during a Type 1 test for the driving distance of a fuel tank and the driving distance of a reagent tank respectively.
2. Reagent indication
 - 2.1. The vehicle shall include a specific indicator on the dashboard that informs the driver when reagent levels are below the threshold values specified in paragraph 3.5.
3. Driver warning system
 - 3.1. The vehicle shall include a warning system consisting of visual alarms that informs the driver when an abnormality is detected in the reagent dosing, e.g. when emissions are too high, the reagent level is low, reagent dosing is interrupted, or the reagent is not of a quality specified by the manufacturer. The warning system may also include an audible component to alert the driver.
 - 3.2. The warning system shall escalate in intensity as the reagent approaches empty. It shall culminate in a driver notification that cannot be easily defeated or ignored. It shall not be possible to turn off the system until the reagent has been replenished.
 - 3.3. The visual warning shall display a message indicating a low level of reagent. The warning shall not be the same as the warning used for the purposes of OBD or other engine maintenance. The warning shall be sufficiently clear for the driver to understand that the reagent level is low (e.g. "urea level low", "AdBlue level low", or "reagent low").
 - 3.4. The warning system does not initially need to be continuously activated, however the warning shall escalate so that it becomes continuous as the level of the reagent approaches the point where the driver inducement system in paragraph 8. comes into effect. An explicit warning shall be displayed (e.g. "fill up urea", "fill up AdBlue", or "fill up reagent"). The continuous warning system may be temporarily interrupted by other warning signals providing that they are important safety related messages.
 - 3.5. The warning system shall activate at a distance equivalent to a driving range of at least 2,400 km in advance of the reagent tank becoming empty, or at the

choice of the manufacturer at the latest when the level of reagent in the tank reaches one of the following levels:

- (a) a level expected to be sufficient for driving 150 per cent of an average driving range with a complete tank of fuel; or
 - (b) 10 per cent of the capacity of the reagent tank,
- whichever occurs earlier.

- 4. Identification of incorrect reagent
 - 4.1. The vehicle shall include a means of determining that a reagent corresponding to the characteristics declared by the manufacturer and recorded in Annex A1 is present on the vehicle.
 - 4.2. If the reagent in the storage tank does not correspond to the minimum requirements declared by the manufacturer the driver warning system in paragraph 3. shall be activated and shall display a message indicating an appropriate warning (e.g. "incorrect urea detected", "incorrect AdBlue detected", or "incorrect reagent detected"). If the reagent quality is not rectified within 50 km of the activation of the warning system then the driver inducement requirements of paragraph 8. shall apply.
- 5. Reagent consumption monitoring
 - 5.1. The vehicle shall include a means of determining reagent consumption and providing off-board access to consumption information.
 - 5.2. Average reagent consumption and average demanded reagent consumption by the engine system shall be available via the serial port of the standard diagnostic connector. Data shall be available over the previous complete 2,400 km period of vehicle operation.
 - 5.3. In order to monitor reagent consumption, at least the following parameters within the vehicle shall be monitored:
 - (a) The level of reagent in the on-vehicle storage tank; and
 - (b) The flow of reagent or injection of reagent as close as technically possible to the point of injection into an exhaust after-treatment system.
 - 5.4. A deviation of more than 50 per cent between the average reagent consumption and the average demanded reagent consumption by the engine system over a period of 30 minutes of vehicle operation, shall result in the activation of the driver warning system in paragraph 3., which shall display a message indicating an appropriate warning (e.g. "urea dosing malfunction", "AdBlue dosing malfunction", or "reagent dosing malfunction"). If the reagent consumption is not rectified within 50 km of the activation of the warning system then the driver inducement requirements of paragraph 8. shall apply.
 - 5.5. In the case of interruption in reagent dosing activity the driver warning system as referred to in paragraph 3. shall be activated, which shall display a message indicating an appropriate warning. Where the reagent dosing interruption is initiated by the engine system because the vehicle operating conditions are such that the vehicle's emission performance does not require reagent dosing, the activation of the driver warning system as referred to in paragraph 3. may be omitted, provided that the manufacturer has clearly informed the approval authority when such operating conditions apply. If the reagent dosing is not rectified within 50 km of the activation of the warning system then the driver inducement requirements of paragraph 8. shall apply.
- 6. Monitoring NO_x emissions
 - 6.1. As an alternative to the monitoring requirements referred to in paragraphs 4. and 5., manufacturers may use exhaust gas sensors directly to sense excess NO_x levels in the exhaust.

- 6.2. The manufacturer shall demonstrate that use of the sensors referred to in paragraph 6.1. and any other sensors on the vehicle, results in the activation of the driver warning system as referred to in paragraph 3., the display of a message indicating an appropriate warning (e.g. “emissions too high — check urea”, “emissions too high — check AdBlue”, “emissions too high — check reagent”), and the activation of the driver inducement system as referred to in paragraph 8.3., when the situations referred to in paragraphs 4.2., 5.4., or 5.5. occur.
- For the purposes of this paragraph these situations are presumed to occur if the applicable NOx OBD threshold limit set out in Table 4 of paragraph 6.8.2. is exceeded.
- NOx emissions during the test to demonstrate compliance with these requirements shall be no more than 20 per cent higher than the OBD threshold limits.
7. Storage of failure information
- 7.1. Where reference is made to this paragraph, non-erasable Parameter Identifiers (PID) shall be stored identifying the reason for and the distance travelled by the vehicle during the inducement system activation. The vehicle shall retain a record of the PID for at least 800 days or 30,000 km of vehicle operation. The PID shall be made available via the serial port of a standard diagnostic connector upon request of a generic scan tool in accordance with the provisions of paragraph 6.5.3.1. of Appendix 1 to Annex C5. The information stored in the PID shall be linked to the period of cumulated vehicle operation, during which it has occurred, with an accuracy of not less than 300 days or 10,000 km.
- 7.2. Malfunctions in the reagent dosing system attributed to technical failures (e.g. mechanical or electrical faults) shall also be subject to the OBD requirements in paragraph 6.8. of this Regulation and Annex C5.
8. Driver inducement system
- 8.1. The vehicle shall include a driver inducement system to ensure that the vehicle operates with a functioning emission control system at all times. The inducement system shall be designed so as to ensure that the vehicle cannot operate with an empty reagent tank.
- 8.1.1. The requirement for a driver inducement system shall not apply to vehicles designed and constructed for use by the rescue services, armed services, civil defence, fire services and forces responsible for maintaining public order. Permanent deactivation of the driver inducement system for these vehicles shall only be done by the vehicle manufacturer.
- 8.2. The inducement system shall activate at the latest when the level of reagent in the tank reaches:
- (a) In the case that the warning system was activated at least 2,400 km before the reagent tank was expected to become empty, a level expected to be sufficient for driving the average driving range of the vehicle with a complete tank of fuel.
 - (b) In the case that the warning system was activated at the level described in paragraph 3.5.(a), a level expected to be sufficient for driving 75 per cent of the average driving range of the vehicle with a complete tank of fuel; or
 - (c) In the case that the warning system was activated at the level described in paragraph 3.5.(b), 5 per cent of the capacity of the reagent tank.
 - (d) In the case that the warning system was activated ahead of the levels described in both paragraph 3.5.(a) and 3.5.(b) but less than 2,400 km in advance of the reagent tank becoming empty, whichever level described in (b) or (c) of this paragraph occurs earlier.

Where the alternative described in paragraph 6.1. is utilised, the system shall activate when the irregularities described in paragraphs 4. or 5. or the NOx levels described in paragraph 6.2. have occurred.

The detection of an empty reagent tank and the irregularities mentioned in paragraphs 4., 5., or 6. shall result in the failure information storage requirements of paragraph 7. taking effect.

- 8.3. The manufacturer shall select which type of inducement system to install. The options for a system are described in paragraphs 8.3.1., 8.3.2. and 8.3.3.
- 8.3.1. A "no engine restart after countdown" approach allows a countdown of restarts or distance remaining once the inducement system activates. Engine starts initiated by the vehicle control system, such as start-stop systems, are not included in this countdown.
- 8.3.1.1. In the case that the warning system was activated at least 2,400 km before the reagent tank was expected to become empty, or the irregularities described in paragraphs 4. or 5. or the NOx levels described in paragraph 6.2. have occurred, engine restarts shall be prevented immediately after the vehicle has travelled a distance expected to be sufficient for driving the average driving range of the vehicle with a complete tank of fuel since the activation of the inducement system.
- 8.3.1.2. In the case that the inducement system was activated at the level described in paragraph 8.2.(b), engine restarts shall be prevented immediately after the vehicle has travelled a distance expected to be sufficient for driving 75 per cent of the average driving range of the vehicle with a complete tank of fuel since the activation of the inducement system.
- 8.3.1.3. In the case that the inducement system was activated at the level described in paragraph 8.2.(c), engine restarts shall be prevented immediately after the vehicle has travelled a distance expected to be sufficient for driving the average driving range of the vehicle with 5 per cent of the capacity of the reagent tank, since the activation of the inducement system.
- 8.3.1.4. In addition, engine restarts shall be prevented immediately after the reagent tank becomes empty, should this situation occur earlier than the situations specified in paragraphs 8.3.1.1, 8.3.1.2., or 8.3.1.3.
- 8.3.2. A "no start after refuelling" system results in a vehicle being unable to start after re-fuelling if the inducement system has activated.
- 8.3.3. A "fuel-lockout" approach prevents the vehicle from being refuelled by locking the fuel filler system after the inducement system activates. The lockout system shall be robust to prevent it being tampered with.
- 8.4. Once the inducement system has prevented engine restarts, the inducement system shall only be deactivated if the irregularities specified in paragraphs 4., 5., or 6. have been rectified or if the quantity of reagent added to the vehicle meets at least one of the following criteria:
- (a) expected to be sufficient for driving 150 per cent of an average driving range with a complete tank of fuel; or
 - (b) at least 10 per cent of the capacity of the reagent tank.

After a repair has been carried out to correct a fault where the OBD system has been triggered under paragraph 7.2., the inducement system may be reinitialised via the OBD serial port (e.g. by a generic scan tool) to enable the vehicle to be restarted for self-diagnosis purposes. The vehicle shall operate for a maximum of 50 km to enable the success of the repair to be validated. The inducement system shall be fully reactivated if the fault persists after this validation.

- 8.5. The driver warning system referred to in paragraph 3. shall display a message indicating clearly:
- (a) The number of remaining restarts and/or the remaining distance; and
 - (b) The conditions under which the vehicle can be restarted.
- 8.6. The driver inducement system shall be deactivated when the conditions for its activation have ceased to exist. The driver inducement system shall not be automatically deactivated without the reason for its activation having been remedied.
- 8.7. Detailed written information fully describing the functional operation characteristics of the driver inducement system shall be provided to the Type Approval Authority at the time of approval.
- 8.8. As part of the application for type approval under this Regulation, the manufacturer shall demonstrate the operation of the driver warning and inducement systems.
9. Information requirements
- 9.1. The manufacturer shall provide all owners of new vehicles with clear written information about any exhaust aftertreatment system which uses a reagent. This information shall state that if such an exhaust aftertreatment system is not functioning correctly, the driver shall be informed of a problem by the driver warning system and that the driver inducement system shall consequentially result in the vehicle being unable to start.
- 9.2. The instructions shall indicate requirements for the proper use and maintenance of vehicles, including the proper use of consumable reagents.
- 9.3. The instructions shall specify if consumable reagents have to be replenished by the vehicle driver between normal maintenance intervals. They shall indicate how the vehicle driver should replenish the reagent tank. The information shall also indicate a likely rate of reagent consumption for that type of vehicle and how often it should be replenished.
- 9.4. The instructions shall specify that use of, and replenishing of, a required reagent of the correct specifications is mandatory for the vehicle to comply with its certificate of conformity.
- 9.5. The instructions shall state that it may be a criminal offence to use a vehicle that does not consume any reagent if it is required for the reduction of emissions.
- 9.6. The instructions shall explain how the warning system and driver inducement systems work. In addition, the consequences of ignoring the warning system and not replenishing the reagent shall be explained.
10. Operating conditions of the after-treatment system
- Manufacturers shall ensure that any exhaust aftertreatment system which uses a reagent retains its emission control function during all ambient conditions, especially at low ambient temperatures. This includes taking measures to prevent the complete freezing of the reagent during parking times of up to 7 days at 258 K (-15 °C) with the reagent tank 50 per cent full. If the reagent is frozen, the manufacturer shall ensure that the reagent shall be liquefied and ready for use within 20 minutes of the vehicle being started at 258 K (-15 °C) measured inside the reagent tank.

Annexes Part A

The Type Approval requirements and documentation included in Annexes Part A are common to the series of amendments which includes Levels 1A / 1B and the series of amendments which includes Level 2 of this Regulation. This means that certain elements may not be required for the level of approval being sought. In such an instance the element may be omitted.

Annex A1

Engine and vehicle characteristics and information concerning the conduct of tests

The following information, when applicable, shall be supplied in triplicate and include a list of contents.

If there are drawings, they shall be to an appropriate scale and show sufficient detail; they shall be presented in A4 format or folded to that format. Photographs, if any, shall show sufficient detail.

If the systems, components or separate technical units have electronic controls, information concerning their performance shall be supplied.

0	GENERAL
0.1.	Make (trade name of manufacturer): ...
0.2.	Type: ...
0.2.1.	Commercial name(s) (if available): ...
0.2.3.	Family identifiers:
0.2.3.1.	Interpolation family: ...
0.2.3.2.	ATCT family(s): ...
0.2.3.4.	Roadload family
0.2.3.4.1.	Roadload family of VH: ...
0.2.3.4.2.	Roadload family of VL: ...
0.2.3.4.3.	Roadload families applicable in the interpolation family: ...
0.2.3.5.	Roadload Matrix family(s): ...
0.2.3.6.	Periodic regeneration family(s): ...
0.2.3.7.	Evaporative test family(s): ...
0.2.3.8.	OBD family(s): ...
0.2.3.9.	Durability family(s): ...
0.2.3.10.	ER family(s): ...
0.2.3.11.	Gas Fuelled Vehicle family(s): ...
0.2.3.12.	other family(s): ...
0.4.	Category of vehicle (°): ...
0.8.	Name(s) and address(es) of assembly plant(s): ...
0.9.	Name and address of the manufacturer's representative (if any): ...
1.	GENERAL CONSTRUCTION CHARACTERISTICS
1.1.	Photographs and/or drawings of a representative vehicle/component/separate technical unit ⁽¹⁾ :
1.3.3.	Powered axles (number, position, interconnection): ...

2.	MASSES AND DIMENSIONS ^(f) ^(g) ⁽⁷⁾ (in kg and mm) (Refer to drawing where applicable)
2.6.	Mass in running order ^(h) (a) maximum and minimum for each variant: ...
2.6.3.	Rotational mass: 3 % of the sum of mass in running order and 25 kg or value, per axle (kg): ...
2.8.	Technically permissible maximum laden mass stated by the manufacturer ⁽ⁱ⁾ ⁽³⁾ : ...
3.	PROPULSION ENERGY CONVERTER ^(k)
3.1.	Manufacturer of the propulsion energy converter(s): ...
3.1.1.	Manufacturer's code (as marked on the propulsion energy converter or other means of identification): ...
3.2.	Internal combustion engine
3.2.1.1.	Working principle: positive ignition/compression ignition/dual fuel ⁽¹⁾ Cycle: four stroke/two stroke/rotary ⁽¹⁾
3.2.1.2.	Number and arrangement of cylinders: ...
3.2.1.2.1.	Bore ⁽¹⁾ : ... mm
3.2.1.2.2.	Stroke ⁽¹⁾ : ... mm
3.2.1.2.3.	Firing order: ...
3.2.1.3.	Engine capacity ^(m) : ... cm ³
3.2.1.4.	Volumetric compression ratio ⁽²⁾ : ...
3.2.1.5.	Drawings of combustion chamber, piston crown and, in the case of positive ignition engines, piston rings: ...
3.2.1.6.	Normal engine idling speed ⁽²⁾ : ... min ⁻¹
3.2.1.6.1.	High engine idling speed ⁽²⁾ : ... min ⁻¹
3.2.1.8.	Rated engine power ⁽ⁿ⁾ : ... kW at ... min ⁻¹ (manufacturer's declared value)
3.2.1.9.	Maximum permitted engine speed as prescribed by the manufacturer: ... min ⁻¹
3.2.1.10.	Maximum net torque ⁽ⁿ⁾ : ... Nm at ... min ⁻¹ (manufacturer's declared value)
3.2.2.	Fuel
3.2.2.1.	Diesel/Petrol/LPG/NG or Biomethane/Ethanol (E 85)/Biodiesel/Hydrogen ⁽¹⁾ ,
3.2.2.1.1.	RON, unleaded: ...
3.2.2.4.	Vehicle fuel type: Mono fuel, Bi fuel, Flex fuel ⁽¹⁾
3.2.2.5.	Maximum amount of biofuel acceptable in fuel (manufacturer's declared value): ... % by volume
3.2.4.	Fuel feed
3.2.4.1.	By carburettor(s): yes/no ⁽¹⁾
3.2.4.2.	By fuel injection (compression ignition or dual fuel only): yes/no ⁽¹⁾
3.2.4.2.1.	System description (common rail/unit injectors/distribution pump etc.): ...
3.2.4.2.2.	Working principle: direct injection/pre-chamber/swirl chamber ⁽¹⁾

3.2.4.2.3.	Injection/Delivery pump
3.2.4.2.3.1.	Make(s): ...
3.2.4.2.3.2.	Type(s): ...
3.2.4.2.3.3.	Maximum fuel delivery ⁽¹⁾ ⁽²⁾ : ... mm ³ /stroke or cycle at an engine speed of: ... min ⁻¹ or, alternatively, a characteristic diagram: ... (When boost control is supplied, state the characteristic fuel delivery and boost pressure versus engine speed)
3.2.4.2.4.	Engine speed limitation control
3.2.4.2.4.2.1.	Speed at which cut-off starts under load: ... min ⁻¹
3.2.4.2.4.2.2.	Maximum no-load speed: ... min ⁻¹
3.2.4.2.6.	Injector(s)
3.2.4.2.6.1.	Make(s): ...
3.2.4.2.6.2.	Type(s): ...
3.2.4.2.8.	Auxiliary starting aid
3.2.4.2.8.1.	Make(s): ...
3.2.4.2.8.2.	Type(s): ...
3.2.4.2.8.3.	System description: ...
3.2.4.2.9.	Electronic controlled injection: yes/no ⁽¹⁾
3.2.4.2.9.1.	Make(s): ...
3.2.4.2.9.2.	Type(s):
3.2.4.2.9.3	Description of the system: ...
3.2.4.2.9.3.1.	Make and type of the control unit (ECU): ...
3.2.4.2.9.3.1.1.	Software version of the ECU: ...
3.2.4.2.9.3.2.	Make and type of the fuel regulator: ...
3.2.4.2.9.3.3.	Make and type of the air-flow sensor: ...
3.2.4.2.9.3.4.	Make and type of fuel distributor: ...
3.2.4.2.9.3.5.	Make and type of the throttle housing: ...
3.2.4.2.9.3.6.	Make and type or working principle of water temperature sensor: ...
3.2.4.2.9.3.7.	Make and type or working principle of air temperature sensor: ...
3.2.4.2.9.3.8.	Make and type or working principle of air pressure sensor: ...
3.2.4.3.	By fuel injection (positive ignition only): yes/no ⁽¹⁾
3.2.4.3.1.	Working principle: intake manifold (single-/multi-point/direct injection ⁽¹⁾ /other (specify): ...
3.2.4.3.2.	Make(s): ...
3.2.4.3.3.	Type(s): ...
3.2.4.3.4.	System description (In the case of systems other than continuous injection give equivalent details): ...
3.2.4.3.4.1.	Make and type of the control unit (ECU): ...

3.2.4.3.4.1.1.	Software version of the ECU: ...
3.2.4.3.4.3.	Make and type or working principle of air-flow sensor: ...
3.2.4.3.4.8.	Make and type of throttle housing: ...
3.2.4.3.4.9.	Make and type or working principle of water temperature sensor: ...
3.2.4.3.4.10.	Make and type or working principle of air temperature sensor: ...
3.2.4.3.4.11.	Make and type or working principle of air pressure sensor: ...
3.2.4.3.5.	Injectors
3.2.4.3.5.1.	Make: ...
3.2.4.3.5.2.	Type: ...
3.2.4.3.7.	Cold start system
3.2.4.3.7.1.	Operating principle(s): ...
3.2.4.3.7.2.	Operating limits/settings ⁽¹⁾ ⁽²⁾ : ...
3.2.4.4.	Feed pump
3.2.4.4.1.	Pressure ⁽²⁾ : ... kPa or characteristic diagram ⁽²⁾ : ...
3.2.4.4.2.	Make(s): ...
3.2.4.4.3.	Type(s): ...
3.2.5.	Electrical system
3.2.5.1.	Rated voltage: ... V, positive/negative ground ⁽¹⁾
3.2.5.2.	Generator
3.2.5.2.1.	Type: ...
3.2.5.2.2.	Nominal output: ... VA
3.2.6.	Ignition system (spark ignition engines only)
3.2.6.1.	Make(s): ...
3.2.6.2.	Type(s): ...
3.2.6.3.	Working principle: ...
3.2.6.6.	Spark plugs
3.2.6.6.1.	Make: ...
3.2.6.6.2.	Type: ...
3.2.6.6.3.	Gap setting: ... mm
3.2.6.7.	Ignition coil(s)
3.2.6.7.1.	Make: ...
3.2.6.7.2.	Type: ...
3.2.7.	Cooling system: liquid/air ⁽¹⁾
3.2.7.1.	Nominal setting of the engine temperature control mechanism: ...
3.2.7.2.	Liquid
3.2.7.2.1.	Nature of liquid: ...

3.2.7.2.2.	Circulating pump(s): yes/no ⁽¹⁾
3.2.7.2.3.	Characteristics: ... or
3.2.7.2.3.1.	Make(s): ...
3.2.7.2.3.2.	Type(s): ...
3.2.7.2.4.	Drive ratio(s): ...
3.2.7.2.5.	Description of the fan and its drive mechanism: ...
3.2.7.3.	Air
3.2.7.3.1.	Fan: yes/no ⁽¹⁾
3.2.7.3.2.	Characteristics: ... or
3.2.7.3.2.1.	Make(s): ...
3.2.7.3.2.2.	Type(s): ...
3.2.7.3.3.	Drive ratio(s): ...
3.2.8.	Intake system
3.2.8.1.	Pressure charger: yes/no ⁽¹⁾
3.2.8.1.1.	Make(s): ...
3.2.8.1.2.	Type(s): ...
3.2.8.1.3.	Description of the system (e.g. maximum charge pressure: ... kPa; wastegate if applicable): ...
3.2.8.2.	Intercooler: yes/no ⁽¹⁾
3.2.8.2.1.	Type: air-air/air-water ⁽¹⁾
3.2.8.3.	Intake depression at rated engine speed and at 100 % load (compression ignition engines only)
3.2.8.4.	Description and drawings of inlet pipes and their accessories (plenum chamber, heating device, additional air intakes, etc.): ...
3.2.8.4.1.	Intake manifold description (include drawings and/or photos): ...
3.2.8.4.2.	Air filter, drawings: ... or
3.2.8.4.2.1.	Make(s): ...
3.2.8.4.2.2.	Type(s): ...
3.2.8.4.3.	Intake silencer, drawings: ... or
3.2.8.4.3.1.	Make(s): ...
3.2.8.4.3.2.	Type(s): ...
3.2.9.	Exhaust system
3.2.9.1.	Description and/or drawing of the exhaust manifold: ...
3.2.9.2.	Description and/or drawing of the exhaust system: ...
3.2.9.3.	Maximum allowable exhaust back pressure at rated engine speed and at 100 % load (compression ignition engines only): ... kPa
3.2.10.	Minimum cross-sectional areas of inlet and outlet ports: ...
3.2.11.	Valve timing or equivalent data

3.2.11.1.	Maximum lift of valves, angles of opening and closing, or timing details of alternative distribution systems, in relation to dead centres. For variable timing system, minimum and maximum timing: ...
3.2.11.2.	Reference and/or setting ranges ⁽¹⁾ : ...
3.2.12.	Measures taken against air pollution
3.2.12.1.	Device for recycling crankcase gases (description and drawings): ...
3.2.12.2.	Pollution control devices (if not covered by another heading)
3.2.12.2.1.	Catalytic converter
3.2.12.2.1.1.	Number of catalytic converters and elements (provide the information below for each separate unit): ...
3.2.12.2.1.2.	Dimensions, shape and volume of the catalytic converter(s): ...
3.2.12.2.1.3.	Type of catalytic action: ...
3.2.12.2.1.4.	Total charge of precious metals: ...
3.2.12.2.1.5.	Relative concentration: ...
3.2.12.2.1.6.	Substrate (structure and material): ...
3.2.12.2.1.7.	Cell density: ...
3.2.12.2.1.8.	Type of casing for the catalytic converter(s): ...
3.2.12.2.1.9.	Location of the catalytic converter(s) (place and reference distance in the exhaust line): ...
3.2.12.2.1.10.	Heat shield: yes/no ⁽¹⁾
3.2.12.2.1.11.	Normal operating temperature range: ... °C
3.2.12.2.1.12.	Make of catalytic converter: ...
3.2.12.2.1.13.	Identifying part number: ...
3.2.12.2.2.	Sensors
3.2.12.2.2.1.	Oxygen and/or lambda sensor(s): yes/no ⁽¹⁾
3.2.12.2.2.1.1.	Make: ...
3.2.12.2.2.1.2.	Location: ...
3.2.12.2.2.1.3.	Control range: ...
3.2.12.2.2.1.4.	Type or working principle: ...
3.2.12.2.2.1.5.	Identifying part number: ...
3.2.12.2.2.2.	NO _x sensor: yes/no ⁽¹⁾
3.2.12.2.2.2.1.	Make: ...
3.2.12.2.2.2.2.	Type: ...
3.2.12.2.2.2.3.	Location
3.2.12.2.2.3.	Particulate sensor: yes/no ⁽¹⁾
3.2.12.2.2.3.1.	Make: ...
3.2.12.2.2.3.2.	Type: ...
3.2.12.2.2.3.3.	Location: ...

3.2.12.2.3.	Air injection: yes/no ⁽¹⁾
3.2.12.2.3.1.	Type (pulse air, air pump, etc.): ...
3.2.12.2.4.	Exhaust gas recirculation (EGR): yes/no ⁽¹⁾
3.2.12.2.4.1.	Characteristics (make, type, flow, high pressure/low pressure/combined pressure, etc.): ...
3.2.12.2.4.2.	Water-cooled system (to be specified for each EGR system e.g. low pressure/high pressure/combined pressure: yes/no ⁽¹⁾
3.2.12.2.5.	Evaporative emissions control system (petrol and ethanol engines only): yes/no ⁽¹⁾
3.2.12.2.5.1.	Detailed description of the devices: ...
3.2.12.2.5.2.	Drawing of the evaporative control system: ...
3.2.12.2.5.3.	Drawing of the carbon canister: ...
3.2.12.2.5.4.	Mass of dry charcoal: ... g
3.2.12.2.5.5.	Schematic drawing of the fuel tank (petrol and ethanol engines only): ...
3.2.12.2.5.5.1.	Fuel tank system capacity, material and construction: ...
3.2.12.2.5.5.2.	Description of vapour hose material, fuel line material and connection technique of the fuel system: ...
3.2.12.2.5.5.3.	Sealed tank system: yes/no
3.2.12.2.5.5.4.	Description of fuel tank relief valve setting (air ingestion and relief): ...
3.2.12.2.5.5.5.	Description of the purge control system: ...
3.2.12.2.5.6.	Description and schematic of the heat shield between tank and exhaust system: ...
3.2.12.2.5.7.	Permeability factor: ...
3.2.12.2.6.	Particulate trap (PT): yes/no ⁽¹⁾
3.2.12.2.6.1.	Dimensions, shape and capacity of the particulate trap: ...
3.2.12.2.6.2.	Design of the particulate trap: ...
3.2.12.2.6.3.	Location (reference distance in the exhaust line): ...
3.2.12.2.6.4.	Make of particulate trap: ...
3.2.12.2.6.5.	Identifying part number: ...
3.2.12.2.7.	On-board-diagnostic (OBD) system: yes/no ⁽¹⁾
3.2.12.2.7.1.	Written description and/or drawing of the MI: ...
3.2.12.2.7.2.	List and purpose of all components monitored by the OBD system: ...
3.2.12.2.7.3.	Written description (general working principles) for
3.2.12.2.7.3.1.	Positive-ignition engines
3.2.12.2.7.3.1.1.	Catalyst monitoring: ...
3.2.12.2.7.3.1.2.	Misfire detection: ...
3.2.12.2.7.3.1.3.	Oxygen sensor monitoring: ...
3.2.12.2.7.3.1.4.	Other components monitored by the OBD system: ...

3.2.12.2.7.3.2.	Compression-ignition engines: ...							
3.2.12.2.7.3.2.1.	Catalyst monitoring: ...							
3.2.12.2.7.3.2.2.	Particulate trap monitoring: ...							
3.2.12.2.7.3.2.3.	Electronic fuelling system monitoring: ...							
3.2.12.2.7.3.2.5.	Other components monitored by the OBD system: ...							
3.2.12.2.7.4.	Criteria for MI activation (fixed number of driving cycles or statistical method): ...							
3.2.12.2.7.5.	List of all OBD output codes and formats used (with explanation of each): ...							
3.2.12.2.7.6.	The following additional information shall be provided by the vehicle manufacturer for the purposes of enabling the manufacture of OBD-compatible replacement or service parts and diagnostic tools and test equipment.							
3.2.12.2.7.6.1.	A description of the type and number of the preconditioning cycles or alternative preconditioning methods used for the original type approval of the vehicle and the reason for their usage.							
3.2.12.2.7.6.2.	A description of the type of the OBD demonstration cycle used for the original type-approval of the vehicle for the component monitored by the OBD system.							
3.2.12.2.7.6.3.	<p>A comprehensive document describing all sensed components with the strategy for fault detection and MI activation (fixed number of driving cycles or statistical method), including a list of relevant secondary sensed parameters for each component monitored by the OBD system. A list of all OBD output codes and format used (with an explanation of each) associated with individual emission related power-train components and individual non-emission related components, where monitoring of the component is used to determine MI activation, including in particular a comprehensive explanation for the data given in service \$05 Test ID \$21 to FF and the data given in service \$06.</p> <p>In the case of vehicle types that use a communication link in accordance with ISO 15765-4 'Road vehicles, diagnostics on controller area network (CAN) — Part 4: requirements for emissions-related systems', a comprehensive explanation for the data given in service \$06 Test ID \$00 to FF, for each OBD monitor ID supported, shall be provided.</p>							
3.2.12.2.7.6.4.	The information required above may be defined by completing a table as described below.							
3.2.12.2.7.6.4.1.	Light-duty vehicles							
	Component	Fault code	Monitoring strategy	Fault detection criteria	MI activation criteria	Secondary parameters	Preconditioning	Demonstration test
	Catalyst	P0420	Oxygen sensor 1 and sensor 2 signals	Difference between sensor 1 and sensor 2 signals-	3rd cycle	Engine speed load, A/F mode, catalyst temperature	Two Type 1 cycles	Type 1
3.2.12.2.8.	Other system: ...							
3.2.12.2.8.2.	Driver inducement system							
3.2.12.2.8.2.3.	Type of inducement system: no engine restart after countdown/no start after refuelling/fuel-lockout/performance restriction							
3.2.12.2.8.2.4.	Description of the inducement system							

3.2.12.2.8.2.5.	Equivalent to the average driving range of the vehicle with a complete tank of fuel: ... km
3.2.12.2.10.	Periodically regenerating system: (provide the information below for each separate unit)
3.2.12.2.10.1.	Method or system of regeneration, description and/or drawing: ...
3.2.12.2.10.2.	The number of Type 1 operating cycles, or equivalent engine test bench cycles, between two cycles where regenerative phases occur under the conditions equivalent to Type 1 test (Distance 'D'): ...
3.2.12.2.10.2.1.	Applicable Type 1 cycle: ...
3.2.12.2.10.2.2.	The number of complete applicable test cycles required for regeneration (distance 'd')
3.2.12.2.10.3.	Description of method employed to determine the number of cycles between two cycles where regenerative phases occur: ...
3.2.12.2.10.4.	Parameters to determine the level of loading required before regeneration occurs (i.e. temperature, pressure etc.): ...
3.2.12.2.10.5.	Description of method used to load system: ...
3.2.12.2.11.	Catalytic converter systems using consumable reagents (provide the information below for each separate unit) yes/no ⁽¹⁾
3.2.12.2.11.1.	Type and concentration of reagent needed: ...
3.2.12.2.11.2.	Normal operational temperature range of reagent: ...
3.2.12.2.11.3.	International standard: ...
3.2.12.2.11.4.	Frequency of reagent refill: continuous/maintenance (where appropriate):
3.2.12.2.11.5.	Reagent indicator: (description and location)
3.2.12.2.11.6.	Reagent tank
3.2.12.2.11.6.1.	Capacity: ...
3.2.12.2.11.6.2.	Heating system: yes/no
3.2.12.2.11.6.2.1.	Description or drawing
3.2.12.2.11.7.	Reagent control unit: yes/no ⁽¹⁾
3.2.12.2.11.7.1.	Make: ...
3.2.12.2.11.7.2.	Type: ...
3.2.12.2.11.8.	Reagent injector (make type and location): ...
3.2.12.2.11.9.	Reagent quality sensor (make, type and location): ...
3.2.12.2.12.	Water injection: yes/no ⁽¹⁾
3.2.14.	Details of any devices designed to influence fuel economy (if not covered by other items):....
3.2.15.	LPG fuelling system: yes/no ⁽¹⁾
3.2.15.1.	Approval number (approval number of UN Regulation No. 67): ...
3.2.15.2.	Electronic engine management control unit for LPG fuelling
3.2.15.2.1.	Make(s): ...

3.2.15.2.2.	Type(s): ...
3.2.15.2.3.	Emission-related adjustment possibilities: ...
3.2.15.3.	Further documentation
3.2.15.3.1.	Description of the safeguarding of the catalyst at switch-over from petrol to LPG or back: ...
3.2.15.3.2.	System lay-out (electrical connections, vacuum connections compensation hoses, etc.): ...
3.2.15.3.3.	Drawing of the symbol: ...
3.2.16.	NG fuelling system: yes/no ⁽¹⁾
3.2.16.1.	Approval number (approval number of UN Regulation No. 110):
3.2.16.2.	Electronic engine management control unit for NG fuelling
3.2.16.2.1.	Make(s): ...
3.2.16.2.2.	Type(s): ...
3.2.16.2.3.	Emission-related adjustment possibilities: ...
3.2.16.3.	Further documentation
3.2.16.3.1.	Description of the safeguarding of the catalyst at switch-over from petrol to NG or back: ...
3.2.16.3.2.	System lay-out (electrical connections, vacuum connections compensation hoses, etc.): ...
3.2.16.3.3.	Drawing of the symbol: ...
3.2.18.	Hydrogen fuelling system: yes/no ⁽¹⁾
3.2.18.1.	Type approval number according to [UN Regulation No. 134 for Fuel Cell, UNR No. [??] for combustion engine]:
3.2.18.2.	Electronic engine management control unit for hydrogen fuelling
3.2.18.2.1.	Make(s): ...
3.2.18.2.2.	Type(s): ...
3.2.18.2.3.	Emission-related adjustment possibilities: ...
3.2.18.3.	Further documentation
3.2.18.3.1.	Description of the safeguarding of the catalyst at switch-over from petrol to hydrogen or back: ...
3.2.18.3.2.	System lay-out (electrical connections, vacuum connections compensation hoses, etc.): ...
3.2.18.3.3.	Drawing of the symbol: ...
3.2.19.4.	Further documentation
3.2.19.4.2.	System lay-out (electrical connections, vacuum connections compensation hoses, etc.): ...
3.2.19.4.3.	Drawing of the symbol: ...
3.2.20.	Heat storage information
3.2.20.1.	Active heat storage device: yes/no ⁽¹⁾

3.2.20.1.1.	Enthalpy: ... (J)
3.2.20.2.	Insulation materials: yes/no ⁽¹⁾
3.2.20.2.1.	Insulation material: ... ^(x)
3.2.20.2.2.	Insulation volume: ... (l) ^(x)
3.2.20.2.3.	Insulation weight: ... (kg) ^(x)
3.2.20.2.4.	Insulation location: ... ^(x)
3.2.20.2.5.	Worst case approach vehicle cool down: yes/no ⁽¹⁾
3.2.20.2.5.1.	(not worst case approach) Minimum soaking time, $t_{\text{soak_ATCT}}$ (hours):... ^(x)
3.2.20.2.5.2.	(not worst case approach) Location of the engine temperature measurement: ... ^(x)
3.2.20.2.6.	Single interpolation family within the ATCT family approach: yes/no ⁽¹⁾
3.2.20.2.7.	Worst case approach with regards to insulation: yes/no ⁽¹⁾
3.2.20.2.7.1.	Description of the ATCT measured reference vehicle regarding insulation: ...
3.3.	Electric powertrain (for PEV only)
3.3.1.	General description of electric power train
3.3.1.1.	Make:
3.3.1.2.	Type:
3.3.1.3.	Use (1): Monomotor/multimotors (number):
3.3.1.4.	Transmission arrangement: parallel/transaxial/others, to precise:
3.3.1.5.	Test voltage: V
3.3.1.6.	Motor nominal speed: min^{-1}
3.3.1.7.	Motor maximum speed: min^{-1} or by default: reducer outlet shaft/gear box speed (specify gear engaged): min^{-1}
3.3.1.9.	Maximum power: kW
3.3.1.10.	Maximum thirty minutes power: kW
3.3.1.11.	Flexible range (where $P > 90$ per cent of max. power): speed at the beginning of range: min^{-1} speed at the end of range: min^{-1}
3.3.2.	Traction REESS
3.3.2.1.	Trade name and mark of the REESS:
3.3.2.2.	Kind of electro-chemical couple:
3.3.2.3.	Nominal voltage: V

3.3.2.4.	REESS maximum thirty minutes power (constant power discharge): kW
3.3.2.5.	REESS performance in 2 h discharge (constant power or constant current): (1)
3.3.2.5.1.	REESS energy: kWh
3.3.2.5.2.	REESS capacity: Ah in 2 h
3.3.2.5.3.	End of discharge voltage value: V
3.3.2.6.	Indication of the end of the discharge that leads to a compulsory stop of the vehicle: (1)
3.3.2.7.	REESS mass: kg
3.3.2.8.	Number of cells:.....
3.3.2.9.	REESS position:.....
3.3.3.	Electric Motor
3.3.3.1.	Working principle:
3.3.3.1.1.	direct current/alternating current (1) /number of phases:
3.3.3.1.2.	separate excitation/series/compound (1)
3.3.3.1.3.	synchronous/asynchronous (1)
3.3.3.1.4.	coiled rotor/with permanent magnets/with housing (1)
3.3.3.1.5.	number of poles of the motor:
3.3.3.2.	Inertia mass:
3.3.4.	Power controller
3.3.4.1.	Make :
3.3.4.2.	Type :
3.3.4.3.	Control principle: vectorial/open loop/closed/other (to be specified): (1)
3.3.4.4.	Maximum effective current supplied to the motor: (2) A during seconds
3.3.4.5.	Voltage range use: V to V
3.3.5.	Cooling system: Motor: liquid/air (1) Controller: liquid/air (1)
3.3.5.1.	Liquid-cooling equipment characteristics:
3.3.5.1.1.	Nature of the liquid circulating pumps: yes/no (1)
3.3.5.1.2.	Characteristics or make(s) and type(s) of the pump:
3.3.5.1.3.	Thermostat: setting:
3.3.5.1.4.	Radiator: drawing(s) or make(s) and type(s):
3.3.5.1.5.	Relief valve: pressure setting:
3.3.5.1.6.	Fan: characteristics or make(s) and type(s):
3.3.5.1.7.	Fan duct:

3.3.5.2.	Air-cooling equipment characteristics
3.3.5.2.1.	Blower: characteristics or make(s) and type(s):
3.3.5.2.2.	Standard air ducting:
3.3.5.2.3.	Temperature regulating system: yes/no (1)
3.3.5.2.4.	Brief description:
3.3.5.2.5.	Air filter: make(s): type(s):
3.3.5.3.	Temperatures admitted by the manufacturer (maximum)
3.3.5.3.1.	Motor outlet:° C
3.3.5.3.2.	controller inlet:° C
3.3.5.3.3.	at motor reference point(s):° C
3.3.5.3.4.	at controller reference point(s):° C
3.3.6.	Insulating category:
3.3.7.	International protection (IP)-code:
3.3.8.	Lubrication system principle: (1) Bearings: friction/ball Lubricant: grease/oil Seal: yes/no Circulation: with/without
3.3.9.	Charger
3.3.9.1.	Charger: on board/external (1) in case of an external unit, define the charger (trademark, model):
3.3.9.2.	Description of the normal profile of charge:
3.3.9.3.	Specification of mains:
3.3.9.3.1.	Type of mains: single phase/three phase (1)
3.3.9.3.2.	Voltage:
3.3.9.4.	Rest period recommended between the end of the discharge and the start of the charge:
3.3.9.5.	Theoretical duration of a complete charge:”]
3.4.	Combinations of propulsion energy converters
3.4.1.	Hybrid electric vehicle: yes/no (1)
3.4.2.	Category of hybrid electric vehicle: off-vehicle charging/not off-vehicle charging: (1)
3.4.3.	Operating mode switch: with/without (1)
3.4.3.1.	Selectable modes
3.4.3.1.1.	Pure electric: yes/no (1)
3.4.3.1.2.	Pure fuel consuming: yes/no (1)
3.4.3.1.3.	Hybrid modes: yes/no (1) (if yes, short description): ...

3.4.4.	Description of the energy storage device: (REESS, capacitor, flywheel/generator)
3.4.4.1.	Make(s): ...
3.4.4.2.	Type(s): ...
3.4.4.3.	Identification number: ...
3.4.4.4.	Kind of electrochemical couple: ...
3.4.4.5.	Energy: ... (for REESS: voltage and capacity Ah in 2 h, for capacitor: J, ...)
3.4.4.6.	Charger: on board/external/without ⁽¹⁾
3.4.5.	Electric machine (describe each type of electric machine separately)
3.4.5.1.	Make: ...
3.4.5.2.	Type: ...
3.4.5.3.	Primary use: traction motor/generator ⁽¹⁾
3.4.5.3.1.	When used as traction motor: single-/multimotors (number) ⁽¹⁾ : ...
3.4.5.4.	Maximum power: ... kW
3.4.5.5.	Working principle
3.4.5.5.1	Direct current/alternating current/number of phases: ...
3.4.5.5.2.	Separate excitation/series/compound ⁽¹⁾
3.4.5.5.3.	Synchronous/asynchronous ⁽¹⁾
3.4.6.	Control unit
3.4.6.1.	Make(s): ...
3.4.6.2.	Type(s): ...
3.4.6.3.	Identification number: ...
3.4.7.	Power controller
3.4.7.1.	Make: ...
3.4.7.2.	Type: ...
3.4.7.3.	Identification number: ...
3.4.9.	Manufacturer's recommendation for preconditioning: ...
3.4.10.	FCHV: yes/no ⁽¹⁾
3.4.10.1.	Type of Fuel Cell
3.4.10.1.2.	Make: ...
3.4.10.1.3.	Type: ...
3.4.10.1.4.	Nominal Voltage (V): ...
3.4.10.1.5.	Type of coolant: air/liquid ⁽¹⁾
3.4.10.2.	System description (working principle of the fuel cell, drawing, etc.): ...
3.5.	Manufacturer's declared values for determination of CO ₂ emissions/fuel consumption/electric energy consumption/electric range
3.5.7.	Manufacturer's declared values

3.5.7.1.	<p>Test vehicle parameters</p> <table border="1"> <thead> <tr> <th data-bbox="584 255 842 427">Vehicle</th> <th data-bbox="849 255 951 427">Vehicle Low (VL) if existing</th> <th data-bbox="954 255 1056 427">Vehicle High (VH)</th> <th data-bbox="1059 255 1161 427">VM if existing</th> <th data-bbox="1165 255 1318 427">V representative (only for road load matrix family*)</th> <th data-bbox="1321 255 1426 427">Default values</th> </tr> </thead> <tbody> <tr> <td data-bbox="584 432 842 472">Vehicle bodywork type</td> <td></td> <td></td> <td>-</td> <td></td> <td></td> </tr> <tr> <td data-bbox="584 477 842 607">Road load method used (measurement or calculation by road load family)</td> <td></td> <td></td> <td>-</td> <td>-</td> <td></td> </tr> <tr> <td colspan="6" data-bbox="584 611 1318 651">Road load information:</td> </tr> <tr> <td data-bbox="584 656 842 732">Tyres make and type, if measurement</td> <td></td> <td></td> <td>-</td> <td></td> <td></td> </tr> <tr> <td data-bbox="584 736 842 831">Tyre dimensions (front/rear), if measurement</td> <td></td> <td></td> <td>-</td> <td></td> <td></td> </tr> <tr> <td data-bbox="584 835 842 902">Tyre rolling resistance (front/rear) (kg/t)</td> <td></td> <td></td> <td></td> <td></td> <td></td> </tr> <tr> <td data-bbox="584 907 842 1001">Tyre pressure (front/rear) (kPa), if measurement</td> <td></td> <td></td> <td></td> <td></td> <td></td> </tr> <tr> <td data-bbox="584 1005 842 1099">Delta $C_D \times A$ of vehicle L compared to vehicle H (IP_H minus IP_L)</td> <td>-</td> <td></td> <td>-</td> <td>-</td> <td></td> </tr> <tr> <td data-bbox="584 1104 842 1296">Delta $C_D \times A$ compared to road load family vehicle L (IP_H/L minus RL_L), if calculation by road load family</td> <td></td> <td></td> <td>-</td> <td>-</td> <td></td> </tr> <tr> <td data-bbox="584 1301 842 1341">Vehicle test mass (kg)</td> <td></td> <td></td> <td></td> <td></td> <td></td> </tr> <tr> <td colspan="6" data-bbox="584 1346 1318 1386">Road load coefficients</td> </tr> <tr> <td data-bbox="584 1391 842 1431">f_0 (N)</td> <td></td> <td></td> <td></td> <td></td> <td></td> </tr> <tr> <td data-bbox="584 1435 842 1476">f_1 (N/(km/h))</td> <td></td> <td></td> <td></td> <td></td> <td></td> </tr> <tr> <td data-bbox="584 1480 842 1520">f_2 (N/(km/h)²)</td> <td></td> <td></td> <td></td> <td></td> <td></td> </tr> <tr> <td data-bbox="584 1525 842 1588">Frontal area m² (0.000 m²)</td> <td>-</td> <td>-</td> <td>-</td> <td></td> <td></td> </tr> <tr> <td data-bbox="584 1592 842 1655">Cycle Energy Demand (J)</td> <td></td> <td></td> <td></td> <td></td> <td></td> </tr> <tr> <td colspan="6" data-bbox="584 1659 1318 1700">* representative vehicle is tested for the road load matrix family</td> </tr> </tbody> </table>	Vehicle	Vehicle Low (VL) if existing	Vehicle High (VH)	VM if existing	V representative (only for road load matrix family*)	Default values	Vehicle bodywork type			-			Road load method used (measurement or calculation by road load family)			-	-		Road load information:						Tyres make and type, if measurement			-			Tyre dimensions (front/rear), if measurement			-			Tyre rolling resistance (front/rear) (kg/t)						Tyre pressure (front/rear) (kPa), if measurement						Delta $C_D \times A$ of vehicle L compared to vehicle H (IP_H minus IP_L)	-		-	-		Delta $C_D \times A$ compared to road load family vehicle L (IP_H/L minus RL_L), if calculation by road load family			-	-		Vehicle test mass (kg)						Road load coefficients						f_0 (N)						f_1 (N/(km/h))						f_2 (N/(km/h) ²)						Frontal area m ² (0.000 m ²)	-	-	-			Cycle Energy Demand (J)						* representative vehicle is tested for the road load matrix family					
Vehicle	Vehicle Low (VL) if existing	Vehicle High (VH)	VM if existing	V representative (only for road load matrix family*)	Default values																																																																																																								
Vehicle bodywork type			-																																																																																																										
Road load method used (measurement or calculation by road load family)			-	-																																																																																																									
Road load information:																																																																																																													
Tyres make and type, if measurement			-																																																																																																										
Tyre dimensions (front/rear), if measurement			-																																																																																																										
Tyre rolling resistance (front/rear) (kg/t)																																																																																																													
Tyre pressure (front/rear) (kPa), if measurement																																																																																																													
Delta $C_D \times A$ of vehicle L compared to vehicle H (IP_H minus IP_L)	-		-	-																																																																																																									
Delta $C_D \times A$ compared to road load family vehicle L (IP_H/L minus RL_L), if calculation by road load family			-	-																																																																																																									
Vehicle test mass (kg)																																																																																																													
Road load coefficients																																																																																																													
f_0 (N)																																																																																																													
f_1 (N/(km/h))																																																																																																													
f_2 (N/(km/h) ²)																																																																																																													
Frontal area m ² (0.000 m ²)	-	-	-																																																																																																										
Cycle Energy Demand (J)																																																																																																													
* representative vehicle is tested for the road load matrix family																																																																																																													
3.5.7.1.1.	Fuel used for the Type 1 test and selected for the measurement of the net power in accordance with UN Regulation No. 85 (for LPG or NG vehicles only): ...																																																																																																												
3.5.7.2.	Combined CO ₂ mass emissions																																																																																																												
3.5.7.2.1.	CO ₂ mass emission for pure ICE vehicles and NOVC-HEVs																																																																																																												
3.5.7.2.1.0.	Minimum and maximum CO ₂ values within the interpolation family: ... g/km																																																																																																												
3.5.7.2.1.1.	Vehicle high: ... g/km																																																																																																												
3.5.7.2.1.2.	Vehicle low (if applicable): ... g/km																																																																																																												

3.5.7.2.1.3.	Vehicle M (if applicable): ... g/km
3.5.7.2.2.	Charge-Sustaining CO ₂ mass emission for OVC-HEVs
3.5.7.2.2.1.	Charge Sustaining CO ₂ mass emission vehicle high: g/km
3.5.7.2.2.2.	Charge Sustaining CO ₂ mass emission vehicle low (if applicable): g/km
3.5.7.2.2.3.	Charge Sustaining CO ₂ mass emission vehicle M (if applicable): g/km
3.5.7.2.3.	Charge Depleting CO ₂ mass emission and weighted CO ₂ mass emission for OVC-HEVs
3.5.7.2.3.1.	Charge Depleting CO ₂ mass emission of Vehicle high: ... g/km
3.5.7.2.3.2.	Charge Depleting CO ₂ mass emission of Vehicle low (if applicable): ... g/km
3.5.7.2.3.3.	Charge Depleting CO ₂ mass emission of Vehicle M (if applicable): ... g/km
3.5.7.2.3.4.	Minimum and maximum weighted CO ₂ values within the OVC interpolation family: ... g/km
3.5.7.3.	Electric range for electrified vehicles
3.5.7.3.1.	Pure Electric Range (PER) for PEVs
3.5.7.3.1.1.	Vehicle high: ... km
3.5.7.3.1.2.	Vehicle low (if applicable): ... km
3.5.7.3.2.	All Electric Range AER for OVC-HEVs and OVC-FCHVs (as applicable)
3.5.7.3.2.1.	Vehicle high: ... km
3.5.7.3.2.2.	Vehicle low (if applicable): ... km
3.5.7.3.2.3.	Vehicle M (if applicable): ... km
3.5.7.4.	Fuel consumption (FC _{CS}) for FCHVs
3.5.7.4.1.	Charge Sustaining fuel consumption for NOVC-FCHVs and OVC-FCHVs (as applicable)
3.5.7.4.1.1.	Vehicle high: ... kg/100 km
3.5.7.4.1.2.	Vehicle low (if applicable): ... kg/100 km
3.5.7.4.1.3.	Vehicle M (if applicable): ... kg/100 km
3.5.7.4.2.	Charge Depleting for OVC-FCHVs (as applicable)
3.5.7.4.2.1.	Vehicle high: ... kg/100 km
3.5.7.4.2.2.	Vehicle low (if applicable): ... kg/100 km
3.5.7.5.	Electric energy consumption for electrified vehicles
3.5.7.5.1.	Combined electric energy consumption (EC _{WLTC}) for Pure electric vehicles
3.5.7.5.1.1.	Vehicle high: ... Wh/km
3.5.7.5.1.2.	Vehicle low (if applicable): ... Wh/km
3.5.7.5.2.	UF-weighted charge-depleting electric energy consumption EC _{AC,CD} (combined)
3.5.7.5.2.1.	Vehicle high: ... Wh/km
3.5.7.5.2.2.	Vehicle low (if applicable): ... Wh/km
3.5.7.5.2.3.	Vehicle M (if applicable): ... Wh/km

3.6.	Temperatures permitted by the manufacturer
3.6.1.	Cooling system
3.6.1.1.	Liquid cooling Maximum temperature at outlet: ... K
3.6.1.2.	Air cooling
3.6.1.2.1.	Reference point: ...
3.6.1.2.2.	Maximum temperature at reference point: ... K
3.6.2.	Maximum outlet temperature of the inlet intercooler: ... K
3.6.3.	Maximum exhaust temperature at the point in the exhaust pipe(s) adjacent to the outer flange(s) of the exhaust manifold or turbocharger: ... K
3.6.4.	Fuel temperature Minimum: ... K — maximum: ... K For diesel engines at injection pump inlet, for gas fuelled engines at pressure regulator final stage
3.6.5.	Lubricant temperature Minimum: ... K — maximum: ... K
3.8.	Lubrication system
3.8.1.	Description of the system
3.8.1.1.	Position of lubricant reservoir: ...
3.8.1.2.	Feed system (by pump/injection into intake/mixing with fuel, etc.) ⁽¹⁾
3.8.2.	Lubricating pump
3.8.2.1.	Make(s): ...
3.8.2.2.	Type(s): ...
3.8.3.	Mixture with fuel
3.8.3.1.	Percentage: ...
3.8.4.	Oil cooler: yes/no ⁽¹⁾
3.8.4.1.	Drawing(s): ... or
3.8.4.1.1.	Make(s): ...
3.8.4.1.2.	Type(s): ...
3.8.5.	Lubricant specification: ...W...
4.	TRANSMISSION ^(P)
4.3.	Moment of inertia of engine flywheel: ...
4.3.1.	Additional moment of inertia with no gear engaged: ...
4.4.	Clutch(es)
4.4.1.	Type: ...
4.4.2.	Maximum torque conversion: ...
4.5.	Gearbox
4.5.1.	Type (manual/automatic/CVT (continuously variable transmission)) ⁽¹⁾

4.5.1.4.	Torque rating: ...			
4.5.1.5.	Number of clutches: ...			
4.6.	Gear ratios			
	Gear	Internal gearbox ratios (ratios of engine to gearbox output shaft revolutions)	Final drive ratio(s) (ratio of gearbox output shaft to driven wheel revolutions)	Total gear ratios
	Maximum for CVT 1 2 3 ... Minimum for CVT			
4.6.1.	Gearshift			
4.6.1.1.	Gear 1 excluded: yes/no ⁽¹⁾			
4.6.1.2.	n_{95_high} for each gear: ... min^{-1}			
4.6.1.3.	n_{min_drive}			
4.6.1.3.1.	1st gear: ... min^{-1}			
4.6.1.3.2.	1st gear to 2nd: ... min^{-1}			
4.6.1.3.3.	2nd gear to standstill: ... min^{-1}			
4.6.1.3.4.	2nd gear: ... min^{-1}			
4.6.1.3.5.	3rd gear and beyond: ... min^{-1}			
4.6.1.4.	$n_{min_drive_set}$ for acceleration/constant speed phases ($n_{min_drive_up}$): ... min^{-1}			
4.6.1.5.	$n_{min_drive_set}$ for deceleration phases ($n_{min_drive_down}$):			
4.6.1.6.	initial period of time			
4.6.1.6.1.	t_{start_phase} : ... S			
4.6.1.6.2.	$n_{min_drive_start}$: ... min^{-1}			
4.6.1.6.3.	$n_{min_drive_up_start}$: ... min^{-1}			
4.6.1.7.	use of ASM: yes/no ⁽¹⁾			
4.6.1.7.1.	ASM values: ... at ... min^{-1}			
4.7.	Maximum vehicle design speed (in km/h) ⁽⁹⁾ : ...			
4.12.	Gearbox lubricant: ...W...			
6.	SUSPENSION			
6.6.	Tyres and wheels			
6.6.1.	Tyre/wheel combination(s)			

6.6.1.1.	Axles
6.6.1.1.1.	Axle 1: ...
6.6.1.1.1.1.	Tyre size designation
6.6.1.1.2.	Axle 2: ...
6.6.1.1.2.1.	Tyre size designation
	etc.
6.6.2.	Upper and lower limits of rolling radii
6.6.2.1.	Axle 1: ...
6.6.2.2.	Axle 2: ...
6.6.3.	Tyre pressure(s) as recommended by the vehicle manufacturer: ... kPa
9.	BODYWORK
9.1.	Type of bodywork ^(c) : ...
12.	MISCELLANEOUS
[12.10.	Devices or systems with driver selectable modes which influence CO ₂ emissions, electric energy consumption and/or criteria emissions and do not have a predominant mode: yes/no ⁽¹⁾
12.10.1.	Charge sustaining test (if applicable) (state for each device or system)
12.10.1.0.	Predominant mode under CS condition: yes/no ⁽¹⁾
12.10.1.0.1.	Predominant mode under CS condition: ... (if applicable)
12.10.1.1.	Best case mode: ... (if applicable)
12.10.1.2.	Worst case mode: ... (if applicable)
12.10.1.3.	Mode which enables the vehicle to follow the reference test cycle: ... (in case no predominant mode under CS condition and only one mode is able to follow the reference test cycle)
12.10.2.	Charge depleting test (if applicable) (state for each device or system)
12.10.2.0.	Predominant mode under CD condition: yes/no ⁽¹⁾
12.10.2.0.1.	Predominant mode under CD condition: ... (if applicable)
12.10.2.1.	Most energy consuming mode: ... (if applicable)
12.10.2.2.	Mode which enables the vehicle to follow the reference test cycle: ... (in case no predominant mode under CD condition and only one mode is able to follow the reference test cycle)
12.10.3.	Type 1 test (if applicable) (state for each device or system)
12.10.3.1.	Best case mode: ...
12.10.3.2.	Worst case mode: ...]

Explanatory notes

- ⁽¹⁾ Delete where not applicable (there are cases where nothing needs to be deleted when more than one entry is applicable).
- ⁽²⁾ Specify the tolerance.
- ⁽³⁾ Please fill in here the upper and lower values for each variant.

- (⁶) ~~Vehicles can be fuelled with both petrol and a gaseous fuel but, where the petrol system is fitted for emergency purposes or starting only and of which the petrol tank cannot contain more than 15 litres of petrol, will be regarded for the test as vehicles which can only run a gaseous fuel.~~ [Not used in the table]
- (⁷) Optional equipment that affects the dimensions of the vehicle shall be specified.
- (⁸) For insulation volume and insulation weight, state to 2 decimal places. Not to be documented if “no” in paragraph 3.2.20.2.5. or 3.2.20.2.7.
- (^c) As defined in the Consolidated Resolution on the Construction of Vehicles (R.E.3.), document ECE/TRANS/WP.29/78/Rev.3, para. 2. - www.unece.org/trans/main/wp29/wp29wgs/wp29gen/wp29resolutions.html.
- (^f) Where there is one version with a normal cab and another with a sleeper cab, both sets of masses and dimensions are to be stated.
- (^g) Standard ISO 612: 1978 — Road vehicles — Dimensions of motor vehicles and towed vehicles — terms and definitions.
- (^h) The mass of the driver is assessed at 75 kg.
The liquid containing systems (except those for used water that must remain empty) are filled to 100 % of the capacity specified by the manufacturer.
- (ⁱ) For trailers or semi-trailers, and for vehicles coupled with a trailer or a semi-trailer, which exert a significant vertical load on the coupling device or the fifth wheel, this load, divided by standard acceleration of gravity, is included in the maximum technically permissible mass.
- (^k) In the case of a vehicle that can run either on petrol, diesel, etc., or also in combination with another fuel, items shall be repeated.
In the case of non-conventional engines and systems, particulars equivalent to those referred to here shall be supplied by the manufacturer.
- (^l) This figure shall be rounded off to the nearest tenth of a millimetre.
- (^m) This value shall be calculated ($\pi = 3.1416$) and rounded off to the nearest cm^3 .
- (ⁿ) Determined in accordance with the requirements of UN Regulation No. 85.
- (^p) The specified particulars are to be given for any proposed variants.
- (^q) With respect to trailers, maximum speed permitted by the manufacturer.

Appendix 1

WLTP Test Report

Test Reports

A Test Report is the report issued by the technical service responsible for conducting the tests according to this regulation.

Part I

The following information, if applicable, is the minimum data required for the Type 1 test.

Report number

APPLICANT			
Manufacturer			
SUBJECT	...		
Roadload family identifier(s)	:		
Interpolation family identifier(s)	:		
Object submitted to tests			
	Make	:	
	IP identifier	:	
CONCLUSION	The object submitted to tests complies with the requirements mentioned in the subject.		

PLACE,	DD/MM/YYYY
--------	------------

General notes:

If there are several options (references), the one tested should be described in the test report

If there are not, a single reference to the information document at the start of the test report may be sufficient.

Every Technical Service is free to include some additional information

Characters are included in the sections of the test report relating to specific vehicle types, as follows:

“(a)” Specific to positive ignition engine vehicles or vehicles ‘G’ (as specified in Table 1B of UNR [xxx]) (as applicable).

“(b)” Specific to compression ignition engine vehicles or vehicles ‘D’ (as specified in Table 1B of UNR [xxx]) (as applicable).

1. Description of tested vehicle(s): high, low and m (if applicable)

1.1. General

Vehicle numbers	:	Prototype number and VIN
Category	:	
Bodywork	:	
Drive wheels	:	

1.1.1. Powertrain Architecture

Powertrain architecture	:	pure ICE, hybrid, electric or fuel cell
-------------------------	---	---

1.1.2. Internal combustion engine (if applicable)

For more than one ICE, please repeat the point

Make	:	
Type	:	
Working principle	:	two/four stroke
Cylinders number and arrangement	:	
Engine capacity (cm ³)	:	
Engine idling speed (min ⁻¹)	:	+ -
High engine idling speed (min ⁻¹) (a)	:	+ -
Rated engine power	:	kW at rpm
Maximum net torque	:	Nm at rpm
Engine lubricant	:	make and type
Cooling system	:	Type: air/water/oil
Insulation	:	material, amount, location, volume and weight

1.1.3. Test fuel for Type 1 test (if applicable)

For more than one test fuel, please repeat the point

Make	:	
Type	:	Petrol - Diesel - LPG - NG - ...
Density at 15°C	:	
Sulphur content	:	Only for Diesel and Petrol
	:	
Batch number	:	
Willans factors (for ICE) for CO ₂ emission (gCO ₂ /MJ)	:	

1.1.4. Fuel feed system (if applicable)

For more than one fuel feed system, please repeat the point

Direct injection	:	yes/no or description
Vehicle fuel type	:	Monofuel / bifuel / flex fuel
Control unit		
Part reference	:	same as information document
Software tested	:	read via scantool, for example
Air flowmeter	:	

Throttle body	:	
Pressure sensor	:	
Injection pump	:	
Injector(s)	:	

1.1.5. Intake system (if applicable)

For more than one intake system, please repeat the point

Pressure charger	:	Yes/no make & type (1)
Intercooler	:	yes/no type (air/air – air/water) (1)
Air filter (element) (1)	:	make & type
Intake silencer (1)	:	make & type

1.1.6. Exhaust system and anti-evaporative system (if applicable)

For more than one, please repeat the point

First catalytic converter	:	make & reference (1) principle: three way / oxidising / NOx trap / NOx storage system / Selective Catalyst Reduction...
Second catalytic converter	:	make & reference (1) principle: three way / oxidising / NOx trap / NOx storage system / Selective Catalyst Reduction...
Particulate trap	:	with/without/not applicable catalysed: yes/no make & reference (1)
Reference and position of oxygen and/or lambda sensor(s)	:	before catalyst / after catalyst
Air injection	:	with/without/not applicable
Water injection	:	with/without/not applicable
EGR	:	with/without/not applicable cooled/non-cooled HP/LP
Evaporative emission control system	:	with/without/not applicable
Reference and position of NOx sensor(s)	:	Before/ after
General description (1)	:	

1.1.7. Heat storage device (if applicable)

For more than one Heat Storage System, please repeat the point

Heat storage device	:	yes/no
Heat capacity (enthalpy stored J)	:	
Time for heat release (s)	:	

1.1.8. Transmission (if applicable)

For more than one Transmission, please repeat the point

Gearbox	:	manual / automatic / continuous variation
Gear shifting procedure		
Predominant mode*	:	yes/no normal / drive / eco/...
Best case mode for CO ₂ emissions and fuel consumption (if applicable)	:	
Worst case mode for CO ₂ emissions and fuel consumption (if applicable)	:	
Highest electric energy consumption mode (if applicable)	:	
Control unit	:	
Gearbox lubricant	:	make and type
Tyres		
Make	:	
Type	:	
Dimensions front/rear	:	
Dynamic circumference (m)	:	
Tyre pressure (kPa)	:	

* for OVC-HEV, specify for charge sustaining and for charge depleting operating conditions.

Transmission ratios (R.T.), primary ratios (R.P.) and (vehicle speed (km/h)) / (engine speed (1000 (min⁻¹)) (V1000) for each of the gearbox ratios (R.B.).

R.B.	R.P.	R.T.	V ₁₀₀₀
1 st	1/1		
2 nd	1/1		
3 rd	1/1		
4 th	1/1		
5 th	1/1		
...			

1.1.9. Electric machine (if applicable)

For more than one Electric Machine, please repeat the point

Make	:	
Type	:	
Peak Power (kW)	:	

1.1.10. Traction REESS (if applicable)

For more than one Traction REESS, please repeat the point

Make	:	
Type	:	
Capacity (Ah)	:	
Nominal Voltage (V)	:	

1.1.11. Fuel cell (if applicable)

For more than one Fuel Cell stack, please repeat the point

Make	:	
Type	:	

1.1.12. Power electronics (if applicable)

Can be more than one PE (propulsion converter, low voltage system or charger)

Make	:	
Type	:	
Power (kW)	:	

1.2. Vehicle high description**1.2.1. Mass**

Test mass of VH (kg)	:	
----------------------	---	--

1.2.2. Road load parameters

f_0 (N)	:	
f_1 (N/(km/h))	:	
f_2 (N/(km/h) ²)	:	
Cycle energy demand (J)	:	
Road load test report reference	:	
Road load family's identifier	:	

1.2.3. Cycle Selection parameters

Cycle (without downscaling)	:	Class 1 / 2 / 3a / 3b
Ratio of rated power to mass in running order – 75kg (PMR)(W/kg)	:	(if applicable)
Capped speed process used during measurement	:	yes/no
Maximum speed of the vehicle (km/h)	:	
Downscaling (if applicable)	:	yes/no
Downscaling factor f_{dsc}	:	
Cycle distance (m)	:	
Constant speed (in the case of the shortened test procedure)	:	if applicable

1.2.4. Gear shift point (if applicable)

Version of Gear Shift calculation		[indicate the applicable amendment to UN GTR No 15]
Gear shifting	:	Average gear for $v \geq 1$ km/h, x.xxxx
n_{min_drive}		
1st gear	:	...min-1
1st gear to 2 nd	:	...min-1
2nd gear to standstill	:	...min-1
2nd gear	:	...min-1
3rd gear and beyond	:	...min-1

Gear 1 excluded	:	yes/no
n_{95_high} for each gear	:	...min-1
$n_{min_drive_set}$ for acceleration/constant speed phases ($n_{min_drive_up}$)	:	...min-1
$n_{min_drive_set}$ for deceleration phases ($n_{min_drive_down}$)	:	...min-1
t_{start_phase}	:	...s
$n_{min_drive_start}$:	...min-1
$n_{min_drive_up_start}$:	...min-1
use of ASM	:	yes/no
ASM values	:	

1.3. Vehicle low description (if APPLICable)

1.3.1. Mass

Test mass of VL(kg)	:	
---------------------	---	--

1.3.2. Road load parameters

f_0 (N)	:	
f_1 (N/(km/h))	:	
f_2 (N/(km/h) ²)	:	
Cycle energy demand (J)	:	
$\Delta(C_D \times A_f)_{LH}$ (m ²)	:	
Road load test report reference	:	
Road load family's identifier	:	

1.3.3. Cycle Selection parameters

Cycle (without downscaling)	:	Class 1 / 2 / 3a / 3b
Ratio of rated power to mass in running order – 75kg (PMR)(W/kg)	:	(if applicable)
Capped speed process used during measurement	:	yes/no
Maximum speed of the vehicle	:	
Downscaling (if applicable)	:	yes/no
Downscaling factor f_{dsc}	:	
Cycle distance (m)	:	
Constant speed (in the case of the shortened test procedure)	:	if applicable

1.3.4. Gear shift point (if applicable)

Gear shifting	:	Average gear for $v \geq 1$ km/h, x.xxxx
---------------	---	--

1.4. Vehicle M description (if APPLICable)

1.4.1. Mass

Test mass of VL(kg)	:	
---------------------	---	--

1.4.2. Road load parameters

f_0 (N)	:	
f_1 (N/(km/h))	:	
f_2 (N/(km/h) ²)	:	
Cycle energy demand (J)	:	
$\Delta(C_D \times A_f)_{LH}$ (m ²)	:	
Road load test report reference	:	
Road load family's identifier	:	

1.4.3. Cycle Selection parameters

Cycle (without downscaling)	:	Class 1 / 2 / 3a / 3b
Ratio of rated power to mass in running order – 75kg (PMR)(W/kg)	:	(if applicable)
Capped speed process used during measurement	:	yes/no
Maximum speed of the vehicle	:	
Downscaling (if applicable)	:	yes/no
Downscaling factor f_{dsc}	:	
Cycle distance (m)	:	
Constant speed (in the case of the shortened test procedure)	:	if applicable

1.4.4. Gear shift point (if applicable)

Gear shifting	:	Average gear for $v \geq 1$ km/h, x.xxxx
---------------	---	--

2. Test results

2.1. Type 1 test

Method of chassis dyno setting	:	Fixed run / iterative / alternative with its own warmup cycle
Dynamometer in 2WD/4WD operation	:	2WD/4WD
For 2WD operation, was the non-powered axle rotating	:	yes/no/not applicable
Dynamometer operation mode	:	yes/no
Coastdown mode	:	yes/no
Additional preconditioning	:	yes/no description
Deterioration factors	:	assigned / tested

2.1.1. Vehicle high

Date of tests	:	(day/month/year)
Place of the test	:	Chassis dyno, location, country
Height of the lower edge above ground of cooling fan (cm)	:	
Lateral position of fan centre (if modified as request by the manufacturer)	:	in the vehicle centre-line/...
Distance from the front of the vehicle (cm)	:	
IWR: Inertial Work Rating (%)	:	x.x
RMSSE: Root Mean Squared Speed Error (km/h)	:	x.xx
Description of the accepted deviation of the driving cycle	:	PEV before break off criteria

	or Fully operated acceleration pedal
--	---

2.1.1.1. Pollutant emissions (if applicable)**2.1.1.1.1. Pollutant emissions of vehicles with at least one combustion engine, of NOVC-HEVS and of OVC-HEVS in case of a charge-sustaining type 1 test**

For each driver selectable mode tested the points below shall be repeated (predominant mode or best case mode and worst case, mode if applicable)

Test 1

Pollutants	CO (mg/km)	THC (a) (mg/km)	NMHC (a) (mg/km)	NO _x (mg/km)	THC+NO _x (b) (mg/km)	Particulate Matter (mg/km)	Particle Number (#.10 ¹¹ /km)
Measured values							
Regeneration factors (Ki) ⁽²⁾ Additive							
Regeneration factors (Ki) ⁽²⁾ Multiplicative							
Deterioration factors (DF) additive							
Deterioration factors (DF) multiplicative							
Final values							
Limit values							

⁽²⁾ See Ki family report(s)	:	
Type 1 performed for Ki determination	:	
Regeneration family's identifier	:	

Test 2 if applicable: for CO₂ reason (d_{CO2}¹) / for pollutants reason (90% of the limits) / for both
Record test results in accordance with the table of Test 1

Test 3 if applicable: for CO₂ reason (d_{CO2}²)
Record test results in accordance with the table of Test 1

2.1.1.1.2. Pollutant emissions of OVC-HEVs in case of a charge-depleting type 1 testTest 1

Pollutant emission limits have to be fulfilled and the following point has to be repeated for each driven test cycle.

Pollutants	CO (mg/km)	THC (a) (mg/km)	NMHC (a) (mg/km)	NO _x (mg/km)	THC+NO _x (b) (mg/km)	Particulate Matter (mg/km)	Particle Number (#.10 ¹¹ /km)
Measured single cycle values							
Limit single cycle values							

Test 2 (if applicable): for CO₂ reason (d_{CO2}¹) / for pollutants reason (90% of the limits) / for both
Record test results in accordance with the table of Test 1

Test 3 (if applicable): for CO₂ reason (d_{CO2}²)
Record test results in accordance with the table of Test 1

2.1.1.1.3. UF-weighted pollutant emissions of OVC-HEVS

Pollutants	CO (mg/km)	THC (a) (mg/km)	NMHC (a) (mg/km)	NO _x (mg/km)	THC+NO _x (b) (mg/km)	Particulate Matter (mg/km)	Particle Number (#.10 ¹¹ /km)

Calculated values							
-------------------	--	--	--	--	--	--	--

2.1.1.2. CO₂ emission (if applicable)

2.1.1.2.1. CO₂ emission of vehicles with at least one combustion engine, of NOVC-HEV and of OVC-HEV in the case of a charge-sustaining Type 1 test

For each driver selectable mode tested the points below have to be repeated (predominant mode or best case mode and worst case, mode if applicable)

Test 1

CO ₂ emission	Low	Medium	High	Extra High	Combined
Measured value M _{CO₂,p,1}					-
Speed and distance corrected value M _{CO₂,p,1b} / M _{CO₂,c,2}					
RCB correction coefficient: ⁽⁵⁾					
M _{CO₂,p,3} / M _{CO₂,c,3}					
Regeneration factors (Ki) Additive					
Regeneration factors (Ki) Multiplicative					
M _{CO₂,c,4}			-		
AF _{Ki} = M _{CO₂,c,3} / M _{CO₂,c,4}			-		
M _{CO₂,p,4} / M _{CO₂,c,4}					-
ATCT correction (FCF) ⁽⁴⁾					
Temporary values M _{CO₂,p,5} / M _{CO₂,c,5}					
Declared value	-	-	-	-	
d_{CO₂}¹ * declared value	-	-	-	-	

⁽⁴⁾ FCF: family correction factor for correcting for representative regional temperature conditions (ATCT)

See ATCT family report(s)	:	
ATCT family's identifier	:	

⁽⁵⁾ correction as referred to in Appendix 2 to Annex B6 of UN Regulation xxx for pure ICE vehicles, and Appendix 2 to Annex B8 of UN Regulation [xxx] for HEVs (K_{CO₂})

Test 2 (if applicable)

Record test results in accordance with the table of Test 1

Test 3 (if applicable)

Record test results in accordance with the table of Test 1

Conclusion

CO ₂ emission (g/km)	Low	Medium	High	Extra High	Combined
Averaging M _{CO₂,p,6} / M _{CO₂,c,6}					
Alignment M _{CO₂,p,7} / M _{CO₂,c,7}					
Final values M _{CO₂,p,H} / M _{CO₂,c,H}					

2.1.1.2.2. CO₂ mass emission of OVC-HEVs in case of a charge-depleting Type 1 test

Test 1:

CO ₂ mass emission (g/km)	Combined
Calculated value M _{CO₂,CD}	
Declared value	
d_{CO₂}¹	

Test 2 (if applicable)

Record test results in accordance with the table of Test 1

Test 3 (if applicable)

Record test results in accordance with the table of Test 1

Conclusion

CO₂ mass emission (g/km)	Combined
Averaging M _{CO₂,CD}	
Final value M_{CO₂,CD}	

2.1.1.2.4. UF-weighted CO₂ mass emission of OVC-HEVs

CO₂ mass emission (g/km)	Combined
Calculated value M _{CO₂,weighted}	

2.1.1.3. Fuel consumption (if applicable)**2.1.1.3.1. Fuel consumption of vehicles with only a combustion engine, of NOVC-HEVs and of OVC-HEVs in case of a charge-sustaining Type 1 test**

For each driver selectable mode tested the points below has to be repeated (predominant mode or best case mode and worst case, mode if applicable)

Fuel consumption (l/100 km) or fuel efficiency (km/l) (as applicable)	Low	Medium	High	Extra High	Combined
Final values FC _{p,H} /FC _{c,H} ⁽⁶⁾ , FE _p , FE _c					

⁽⁶⁾ Calculated from aligned CO₂ values

A- On-board Fuel and/or Energy Consumption Monitoring for vehicles referred to in paragraph 5.11. of this Regulation

- Data accessibility

The parameters listed in paragraph 3 of Appendix 5 to this Regulation are accessible: yes/not applicable

- b. Accuracy (if applicable)

Fuel_ConsumedWLTP (litres) ⁽⁸⁾	Vehicle HIGH - Test 1	x.xxx
	Vehicle HIGH - Test 2 (if applicable)	x.xxx
	Vehicle HIGH - Test 3 (if applicable)	x.xxx
	Vehicle LOW - Test 1 (if applicable)	x.xxx
	Vehicle LOW Test 2 (if applicable)	x.xxx
	Vehicle LOW - Test 3 (if applicable)	x.xxx
	Total	x.xxx
Fuel_ConsumedOBFCM (litres) ⁽⁸⁾	Vehicle HIGH - Test 1	x.xxx
	Vehicle HIGH - Test 2 (if applicable)	x.xxx
	Vehicle HIGH - Test 3 (if applicable)	x.xxx
	Vehicle LOW - Test 1 (if applicable)	x.xxx
	Vehicle LOW Test 2 (if applicable)	x.xxx
	Vehicle LOW - Test 3 (if applicable)	x.xxx
	Total	x.xxx
Accuracy ⁽⁸⁾	x.xxx	

⁽⁸⁾ in accordance with Appendix 5 to this Regulation**2.1.1.3.2. Fuel consumption of OVC-HEVs and OVC-FCHVs (as applicable) in case of a charge-depleting Type 1 test**Test 1:

Fuel consumption (l/100 km or kg/100 km) or fuel efficiency (km/l) (as applicable)	Combined
Calculated value FC _{CD} , FE _{CD}	

Test 2 (if applicable)

Record test results in accordance with the table of Test 1

Test 3 (if applicable)

Record test results in accordance with the table of Test 1

Conclusion

Fuel consumption (l/100km or kg/100 km) or fuel efficiency (km/l) (as applicable)	Combined
Averaging FC_{CD} , FE_{CD}	
Final value FC_{CD} , FE_{CD}	

2.1.1.3.3. UF-Weighted Fuel consumption of OVC-HEVs and OVC-FCHVs (as applicable)

Fuel consumption (l/100 km for kg/100 km) or fuel efficiency (km/l) (as applicable)	Combined
Calculated value $FC_{weighted}$, $FE_{weighted}$	

2.1.1.3.4. Fuel consumption of vehicles of NOVC-FCHVs and OVC-FCHVs (as applicable) in case of a charge-sustaining Type 1 test

For each driver selectable mode tested the points below has to be repeated (predominant mode or best case mode and worst case, mode if applicable)

Fuel consumption (kg/100 km) or fuel efficiency (km/kg) (as applicable)	Combined
Measured values	
RCB correction coefficient	
Final values FC_c , FE_c	

2.1.1.4. Ranges (if applicable)

2.1.1.4.1. Ranges for OVC-HEVs and OVC-FCHVs (as applicable)

2.1.1.4.1.1. All electric range

Test 1

AER (km)	City	Combined
Measured/Calculated values AER		
Declared value	-	

Test 2 (if applicable)

Record test results in accordance with the table of Test 1

Test 3 (if applicable)

Record test results in accordance with the table of Test 1

Conclusion

AER (km)	City	Combined
Averaging AER (if applicable)		
Final values AER		

2.1.1.4.1.2. Equivalent All electric Range

EAER (km)	Low	Medium	High	Extra High	City	Combined
Final values EAER						

2.1.1.4.1.3. Actual Charge-Depleting Range

R_{CDA} (km)	Combined
Final value R_{CDA}	

2.1.1.4.1.4. Charge-Depleting Cycle Range

Test 1

R_{CDC} (km)	Combined
Final value R_{CDC}	
Index Number of the transition cycle	
REEC of confirmation-cycle (%)	

Test 2 (if applicable)

Record test results in accordance with the table of Test 1

Test 3 (if applicable)

Record test results in accordance with the table of Test 1

2.1.1.4.2. Ranges for PEVs - Pure electric range (if applicable)

Test 1

PER (km)	Low	Medium	High	Extra High	City	Combined
Calculated values PER						
Declared value	-	-	-	-	-	

Test 2 (if applicable)

Record test results in accordance with the table of Test 1

Test 3 (if applicable)

Record test results in accordance with the table of Test 1

Conclusion

PER (km)	City	Combined
Averaging PER		
Final values PER		

2.1.1.5. Electric energy consumption (if applicable)

2.1.1.5.1. Electric energy consumption of OVC-HEVs and OVC-FCHVs (as applicable)

2.1.1.5.1.1. Recharged electric energy (E_{AC})

E_{AC} (Wh)	
---------------	--

2.1.1.5.1.2. Electric energy consumption (EC)

EC (Wh/km)	Low	Medium	High	Extra High	City	Combined
Final values EC						

2.1.1.5.1.3. UF-weighted charge-depleting electric energy consumption

Test 1

EC_{AC,CD} (Wh/km)	Combined
Calculated value EC _{AC,CD}	

Test 2 (if applicable)

Record test results in accordance with the table of Test 1

Test 3 (if applicable)

Record test results in accordance with the table of Test 1

Conclusion (if applicable)

EC_{AC,CD} (Wh/km)	Combined
Averaging EC _{AC,CD}	
Final value	

2.1.1.5.1.4. UF-weighted electric energy consumption

Test 1

EC_{AC,weighted} (Wh)	Combined
Calculated value EC _{AC,weighted}	

Test 2 (if applicable)

Record test results in accordance with the table of Test 1

Test 3 (if applicable)

Record test results in accordance with the table of Test 1

Conclusion (if applicable)

EC_{AC,weighted} (Wh/km)	Combined
Averaging EC _{AC,weighted}	
Final value	

2.1.1.5.1.5. Information for COP

	Combined
Electric energy consumption (Wh/km) EC _{DC,CD,COP}	
AF _{EC,AC,CD}	

2.1.1.5.2. Electric energy consumption of PEVs (if applicable)

Test 1

E _{AC} (Wh)	
----------------------	--

EC (Wh/km)	City	Combined
Calculated values EC		
Declared value	-	

Test 2 (if applicable)

Record test results in accordance with the table of Test 1

Test 3 (if applicable)

Record test results in accordance with the table of Test 1

EC (Wh/km)	Low	Medium	High	Extra High	City	Combined
Averaging EC						
Final values EC						

Information for COP

	Combined
Electric Energy Consumption (Wh/km) EC _{DC,COP}	
AF _{EC}	

2.1.2. Vehicle low (if applicable)

Repeat paragraph 2.1.1.

2.1.3. Vehicle M (if applicable)

Repeat paragraph 2.1.1.

2.1.4. Final criteria emissions values (if applicable)

Pollutants	CO (mg/km)	THC (a) (mg/km)	NMHC (a) (mg/km)	NO _x (mg/km)	THC+NO _x (b) (mg/km)	PM (mg/km)	PN (#.10 ¹¹ /km)
Highest values⁽³⁾							

⁽³⁾ for each pollutant within all test results of VH, VL (if applicable) and VM (if applicable)**2.4. Type 4 (a) test**

Family's identifier	:	
See report(s)	:	

2.5. Type 5 test

Family's identifier	:	
See durability family report(s)	:	
Type 1 cycle for criteria emissions testing	:	³
Durability family identifier	:	

2.8. On board diagnostic system

Family's identifier	:	
See family report(s)	:	

2.11. Temperature information related to vehicle high (VH)

Worst case approach with regards to vehicle insulation	:	yes/no ⁽⁷⁾
Worst case approach vehicle cool down	:	yes/no ⁽⁷⁾
ATCT family composed of a single Interpolation family	:	yes/no ⁽⁷⁾
Engine coolant temperature at the end of soaking time (°C)	:	
Average soak area temperature over the 3 last hours (°C)	:	
Difference between engine coolant end temperature and average soak area temperature of the last 3 hours ΔT_{ATCT} (°C)	:	
The minimum soaking time t_{soak_ATCT} (s)	:	
Location of temperature sensor	:	
Measured engine temperature	:	oil/coolant

⁽⁷⁾ if "yes" then the six last lines are not applicable**2.12. Exhaust after-treatment system using reagent**

Family's identifier	:	
See family report(s)	:	

Part II

The following information, if applicable, is the minimum data required for the ATCT test.

Report number

APPLICANT			
Manufacturer			
SUBJECT	...		
Roadload family identifier(s)	:		
Interpolation family identifier(s)	:		
ATCT identifier(s)	:		
Object submitted to tests			
	Make	:	
	IP identifier	:	
CONCLUSION	The object submitted to tests complies with the requirements mentioned in the subject.		

PLACE,	DD/MM/YYYY
--------	------------

General notes:

If there are several options (references), the one tested should be described in the test report

If there are not, a single reference to the information document at the start of the test report may be sufficient.

Every Technical Service is free to include some additional information.

Characters are included in the sections of the test report relating to specific vehicle types, as follows:

- “(a)” Specific to positive ignition engine vehicles or vehicles ‘G’ (as specified in Table 1B of UNR [xxx]) (as applicable).
- “(b)” Specific to compression ignition engine vehicles or vehicles ‘D’ (as specified in Table 1B of UNR [xxx]) (as applicable).

1. Description of tested vehicle

1.1. General

Vehicle numbers	:	Prototype number and VIN	
Category	:		
Bodywork	:		
Drive wheels	:		

1.1.1. Powertrain Architecture

Powertrain architecture	:	pure ICE, hybrid, electric or fuel cell	
-------------------------	---	---	--

1.1.2. Internal combustion engine (if applicable)

For more than one ICE, please repeat the point

Make	:				
Type	:				
Working principle	:	two/four stroke			
Cylinders number and arrangement	:				
Engine capacity (cm ³)	:				
Engine idling speed (min ⁻¹)	:		±		
High engine idling speed (min ⁻¹) (a)	:		±		
Rated engine power	:		kW	At	rpm

Maximum net torque	:		Nm	At		rpm
Engine lubricant	:	make and type				
Cooling system	:	Type: air/water/oil				
Insulation	:	material, amount, location, volume and weight				

1.1.3. Test fuel for type 1 test (if applicable)

For more than one test fuel, please repeat the point

Make	:	
Type	:	Petrol - Diesel – LPG – NG - ...
Density at 15°C	:	
Sulphur content	:	Only for Diesel and Petrol
Annex IX	:	
Batch number	:	
Willans factors (for ICE) for CO ₂ emission (gCO ₂ /MJ)	:	
Direct injection	:	yes/no or description
Vehicle fuel type	:	Monofuel / bifuel / flex fuel
Control unit		
Part reference	:	same as information document
Software tested	:	read via scantool, for example
Air flowmeter	:	
Throttle body	:	
Pressure sensor	:	
Injection pump	:	
Injector(s)	:	

1.1.4. Fuel feed system (if applicable)

For more than one fuel feed system, please repeat the point

1.1.5. Intake system (if applicable)

For more than one intake system, please repeat the point

Pressure charger	:	Yes/no make & type (1)
Intercooler	:	yes/no type (air/air – air/water) (1)
Air filter (element) (1)	:	make & type
Intake silencer (1)	:	make & type

1.1.6. Exhaust system and anti-evaporative system (if applicable)

For more than one, please repeat the point

First catalytic converter	:	make & reference (1) principle: three way / oxidising / NOx trap / Nox storage system / Selective Catalyst Reduction...
Second catalytic converter	:	make & reference (1) principle: three way / oxidising / NOx trap / Nox storage system / Selective Catalyst Reduction...
Particulate trap	:	with/without/not applicable

		catalysed: yes/no make & reference (1)
Reference and position of oxygen and/or lambda sensor(s)	:	before catalyst / after catalyst
Air injection	:	with/without/not applicable
Water injection	:	with/without/not applicable
EGR	:	with/without/not applicable cooled/non-cooled HP/LP
Evaporative emission control system	:	with/without/not applicable
Reference and position of NOx sensor(s)	:	Before/ after
General description (1)	:	

1.1.7. Heat storage device (if applicable)

For more than one Heat Storage System, please repeat the point

Heat storage device	:	yes/no
Heat capacity (enthalpy stored J)	:	
Time for heat release (s)	:	

1.1.8. Transmission (if applicable)

For more than one Transmission, please repeat the point

Gearbox	:	manual / automatic / continuous variation
Gear shifting procedure		
Predominant mode	:	yes/no normal / drive / eco/...
Best case mode for CO ₂ emissions and fuel consumption (if applicable)	:	
Worst case mode for CO ₂ emissions and fuel consumption (if applicable)	:	
Control unit	:	
Gearbox lubricant	:	make and type
Tyres		
Make	:	
Type	:	
Dimensions front/rear	:	
Dynamic circumference (m)	:	
Tyre pressure (kPa)	:	

Transmission ratios (R.T.), primary ratios (R.P.) and (vehicle speed (km/h) / (engine speed (1000 (min⁻¹)) (V₁₀₀₀)) for each of the gearbox ratios (R.B.).

R.B.	R.P.	R.T.	V ₁₀₀₀
1 st	1/1		
2 nd	1/1		
3 rd	1/1		
4 th	1/1		
5 th	1/1		
...			

1.1.9. Electric machine (if applicable)

For more than one electric machine, please repeat the point

Make	:	
Type	:	
Peak Power (kW)	:	

1.1.10. Traction REESS (if applicable)

For more than one traction REESS, please repeat the point

Make	:	
Type	:	
Capacity (Ah)	:	
Nominal Voltage (V)	:	

1.1.11. Reserved

1.1.12. Power electronics (if applicable)

Can be more than one PE (propulsion converter, low voltage system or charger)

Make	:	
Type	:	
Power (kW)	:	

1.2. Vehicle description

1.2.1. Mass

Test mass of VH (kg)	:	
----------------------	---	--

1.2.2. Road load parameters

f ₀ (N)	:	
f ₁ (N/(km/h))	:	
f ₂ (N/(km/h) ²)	:	
f _{2_TReg} (N/(km/h) ²)	:	
Cycle energy demand (J)	:	
Road load test report reference	:	
Road load family's identifier	:	

1.2.3. Cycle selection parameters

Cycle (without downscaling)	:	Class 1 / 2 / 3a / 3b
Ratio of rated power to mass in running order -75kg (PMR)(W/kg)	:	(if applicable)
Capped speed process used during measurement	:	yes/no
Maximum speed of the vehicle (km/h)	:	
Downscaling (if applicable)	:	yes/no
Downscaling factor fdsc	:	
Cycle distance (m)	:	
Constant speed (in the case of the shortened test procedure)	:	if applicable

1.2.4. Gear shift point (if applicable)

Version of Gear Shift calculation		(indicate the applicable amendment to UN GTR No. 15)
Gear shifting	:	Average gear for $v \geq 1$ km/h, rounded to four places of decimal
n_{min} drive		
1st gear	:	...min ⁻¹
1st gear to 2nd	:	...min ⁻¹
2nd gear to standstill	:	...min ⁻¹
2nd gear	:	...min ⁻¹
3rd gear and beyond	:	...min ⁻¹
Gear 1 excluded	:	yes/no
n _{95_high} for each gear	:	...min ⁻¹
n _{min_drive_set} for acceleration/constant speed phases (n _{min_drive_up})	:	...min ⁻¹
n _{min_drive_set} for deceleration phases (n _{min_drive_down})	:	...min ⁻¹
t _{start_phase}	:	...s
n _{min_drive_start}	:	...min ⁻¹
n _{min_drive_up_start}	:	...min ⁻¹
use of ASM	:	yes/no
ASM values	:	

2. Test results

Method of chassis dyno setting	:	Fixed run / iterative / alternative with its own warmup cycle
Dynamometer in 2WD/4WD operation	:	2WD/4WD
For 2WD operation, was the non-powered axle rotating	:	yes/no/not applicable
Dynamometer operation mode	:	yes/no
Coastdown mode	:	yes/no

2.1 Test at 14°C

Date of tests	:	(day/month/year)
Place of the test	:	
Height of the lower edge above ground of cooling fan (cm)	:	
Lateral position of fan centre (if modified as request by the manufacturer)	:	in the vehicle centre-line/...
Distance from the front of the vehicle (cm)	:	
IWR: Inertial Work Rating (%)	:	x.x
RMSSE: Root Mean Squared Speed Error (km/h)	:	x.xx
Description of the accepted deviation of the driving cycle	:	Fully operated acceleration pedal

2.1.1. Pollutant emissions of vehicle with at least one combustion engine, of NOVC-HEVs and of OVC-HEVs in case of a charge-sustaining

Pollutants	CO (mg/km)	THC (a) (mg/km)	NMHC (a) (mg/km)	NO _x (mg/km)	THC+NO _x (b) (mg/km)	Particulate Matter (mg/km)	Particle Number (#.10 ¹¹ /km)
Measured values							
Limit values							

2.1.2. CO₂ emission of vehicle with at least one combustion engine, of NOVC-HEV and of OVC-HEV in case of a charge-sustaining tests

CO ₂ emission (g/km)	Low	Medium	High	Extra High	Combined
Measured value M _{CO₂,p,1}					-
Measured Speed and distance corrected value M _{CO₂,p,1b} / M _{CO₂,e,2}					
RCB correction coefficient ⁽²⁾					
M _{CO₂,p,3} / M _{CO₂,e,3}					

⁽²⁾ correction as referred to in Appendix 2 to Annex B6 of UN Regulation No. [xxx] for ICE vehicles, K_{CO₂} for HEVs

2.2 Test at 23°C

Provide information or refer to type 1 test report

Date of tests	:	(day/month/year)
Place of the test	:	
Height of the lower edge above ground of cooling fan (cm)	:	
Lateral position of fan centre (if modified as request by the manufacturer)	:	in the vehicle centre-line/...
Distance from the front of the vehicle (cm)	:	
IWR: Inertial Work Rating (%)	:	x.x
RMSSE: Root Mean Squared Speed Error (km/h)	:	x.xx
Description of the accepted deviation of the driving cycle	:	Fully operated acceleration pedal

2.2.1. Pollutant emissions of vehicle with at least one combustion engine, of NOVC-HEVs and of OVC-HEVs in case of a charge-sustaining

Pollutants	CO (mg/km)	THC (a) (mg/km)	NMHC (a) (mg/km)	NO _x (mg/km)	THC+NO _x (b) (mg/km)	Particulate Matter (mg/km)	Particle Number (#.10 ¹¹ /km)
Final values							
Limit values							

2.2.2. CO₂ emission of vehicle with at least one combustion engine, of NOVC-HEV and of OVC-HEV in case of a charge-sustaining tests

CO ₂ emission (g/km)	Low	Medium	High	Extra High	Combined
Measured value $M_{CO_2,p,1}$					-
Measured Speed and distance corrected value $M_{CO_2,p,1b} / M_{CO_2,e,2}$					
RCB correction coefficient ⁽²⁾					
$M_{CO_2,p,3} / M_{CO_2,e,3}$					

⁽²⁾ correction as referred to in Appendix 2 to Annex B6 of this UN Regulation for ICE vehicles, and Appendix 2 to Annex B8 of this UN Regulation for HEVs (K_{CO_2})

2.3. Conclusion

CO ₂ emission (g/km)	Combined
ATCT (14°C) $M_{CO_2,Treg}$	
Type 1 (23°C) $M_{CO_2,23^\circ}$	
Family correction factor (FCF)	

2.4. Temperature information of the reference vehicle after 23°C test

Worst case approach with regards to vehicle insulation	:	yes/no ⁽³⁾
Worst case approach vehicle cool down	:	yes/no ⁽³⁾
ATCT family composed of a single Interpolation family	:	yes/no ⁽³⁾
Engine coolant temperature at the end of soaking time (°C)	:	
Average soak area temperature over the 3 last hours (°C)	:	
Difference between engine coolant end temperature and average soak area temperature of the last 3 hours Δ_{T_ATCT} (°C)	:	
The minimum soaking time t_{soak_ATCT} (s)	:	
Location of temperature sensor	:	
Measured engine temperature	:	oil/coolant

⁽³⁾ if “yes” then the six last lines are not applicable

Appendix 2

WLTP Road Load Test Report

Road Load Test Report

The following information, if applicable, is the minimum data required for the road load determination test.

Report number

APPLICANT			
Manufacturer			
SUBJECT	Determination of a vehicle road load /...		
Roadload family identifier(s)	:		
Object submitted to tests			
	Make	:	
	Type	:	
CONCLUSION	The object submitted to tests complies with the requirements mentioned in the subject.		

PLACE,

DD/MM/YYYY

1. Concerned vehicle(s)

Make(s) concerned	:	
Type(s) concerned	:	
Commercial description	:	
Maximal speed (km/h)	:	
Powered axle(s)	:	

2. Description of tested vehicles

If no interpolation: the worst-case vehicle (regarding energy demand) shall be described

2.1. Wind tunnel method

Combination with	:	Flat belt dynamometer / chassis dynamometer
------------------	---	---

2.1.1 General

	Wind tunnel		Dynamometer	
	H _R	L _R	H _R	L _R
Make				
Type				
Version				
Cycle energy demand over a complete WLTC Class 3 cycle (kJ)				
Deviation from production series	-	-		
Mileage (km)	-	-		

Or (in case of roadload matrix family):

Make	:	
Type	:	
Version	:	
Cycle energy demand over a complete WLTC (kJ)	:	
Deviation from production series	:	
Mileage (km)	:	

2.1.2 Masses

	Dynamometer	
	H _R	L _R
Test mass (kg)		
Average mass m _{av} (kg)		
Value of m _r (kg per axle)		
Category M vehicle: proportion of the vehicle mass in running order on the front axle (%)		
Category N vehicle: weight distribution (kg or %)		

Or (in case of roadload matrix family):

Test mass (kg)	:	
Average mass m _{av} (kg)	:	(average before and after the test)
Technically permissible maximum laden mass	:	
Estimated arithmetic average of the mass of optional equipment	:	
Category M vehicle: proportion of the vehicle mass in running order on the front axle (%)	:	
Category N vehicle: weight distribution (kg or %)	:	

2.1.3 Tyres

	Wind tunnel		Dynamometer	
	H _R	L _R	H _R	L _R
Size designation				
Make				
Type				
Rolling resistance				
Front (kg/t)	-	-		
Rear (kg/t)	-	-		
Tyre pressure				
Front (kPa)	-	-		
Rear (kPa)	-	-		

Or (in case of roadload matrix family):

Size designation	
Make	:
Type	:
Rolling resistance	
Front (kg/t)	:
Rear (kg/t)	:
Tyre pressure	

Front (kPa)	:	
Rear (kPa)	:	

2.1.4. Bodywork

	Wind tunnel	
	H _R	L _R
Type	AA/AB/AC/AD/AE/AF BA/BB/BC/BD	
Version		
Aerodynamic devices		
Movable aerodynamic body parts	y/n and list if applicable	
Installed aerodynamic options list		
Delta ($C_D \times A_{fLH}$ compared to H _R (m ²))	-	

Or (in case of roadload matrix family):

Body shape description	:	Square box (if no representative body shape for a complete vehicle can be determined)
Frontal area A _{fr} (m ²)	:	

2.2. On road

2.2.1. General

	H _R	L _R
Make		
Type		
Version		
Cycle energy demand over a complete WLTC Class 3 cycle (kJ)		
Deviation from production series		
Mileage		

Or (in case of roadload matrix family):

Make	:	
Type	:	
Version	:	
Cycle energy demand over a complete WLTC (kJ)	:	
Deviation from production series	:	
Mileage (km)	:	

2.2.2 Masses

	H _R	L _R
Test mass (kg)		
Average mass m _{av} (kg)		
Value of m _r (kg per axle)		
Category M vehicle: proportion of the vehicle mass in running order on the front axle (%)		
Category N vehicle: weight distribution (kg or %)		

Or (in case of roadload matrix family):

Test mass (kg)	:	
Average mass m_{av} (kg)	:	(average before and after the test)
Technically permissible maximum laden mass	:	
Estimated arithmetic average of the mass of optional equipment	:	
Category M vehicle: proportion of the vehicle mass in running order on the front axle (%)		
Category N vehicle: weight distribution (kg or %)		

2.2.3 Tyres

	H_R	L_R
Size designation		
Make		
Type		
Rolling resistance		
Front (kg/t)		
Rear (kg/t)		
Tyre pressure		
Front (kPa)		
Rear (kPa)		

Or (in case of roadload matrix family):

Size designation	:	
Make	:	
Type	:	
Rolling resistance		
Front (kg/t)	:	
Rear (kg/t)	:	
Tyre pressure		
Front (kPa)	:	
Rear (kPa)	:	

2.2.4. Bodywork

	H_R	L_R
Type	AA/AB/AC/AD/AE/AF BA/BB/BC/BD	
Version		
Aerodynamic devices		
Movable aerodynamic body parts	y/n and list if applicable	
Installed aerodynamic options list		
Delta ($C_D \times A_f$) _{LH} compared to H _R (m ²)	-	

Or (in case of roadload matrix family):

Body shape description	:	Square box (if no representative body shape for a complete vehicle can be determined)
Frontal area A_f (m ²)	:	

2.3. Powertrain

2.3.1. Vehicle High

Engine code	:																												
Transmission type	:	manual, automatic, CVT																											
Transmission model (manufacturer's codes)	:	(torque rating and no of clutches → to be included in info doc)																											
Covered transmission models (manufacturer's codes)	:																												
Engine rotational speed divided by vehicle speed	:	<table border="1"> <thead> <tr> <th>Gear</th> <th>Gear ratio</th> <th>N/V ratio</th> </tr> </thead> <tbody> <tr> <td>1st</td> <td>1/..</td> <td></td> </tr> <tr> <td>2nd</td> <td>1..</td> <td></td> </tr> <tr> <td>3rd</td> <td>1/..</td> <td></td> </tr> <tr> <td>4th</td> <td>1/..</td> <td></td> </tr> <tr> <td>5th</td> <td>1/..</td> <td></td> </tr> <tr> <td>6th</td> <td>1/..</td> <td></td> </tr> <tr> <td>..</td> <td></td> <td></td> </tr> <tr> <td>..</td> <td></td> <td></td> </tr> </tbody> </table>	Gear	Gear ratio	N/V ratio	1 st	1/..		2 nd	1..		3 rd	1/..		4 th	1/..		5 th	1/..		6 th	1/..			
Gear	Gear ratio	N/V ratio																											
1 st	1/..																												
2 nd	1..																												
3 rd	1/..																												
4 th	1/..																												
5 th	1/..																												
6 th	1/..																												
..																													
..																													
Electric machine(s) coupled in position N	:	n.a. (no electric machine or no coastdown mode)																											
Type and number of electric machines	:	construction type: asynchronous/ synchronous...																											
Type of coolant	:	air, liquid, ...																											

2.3.2. Vehicle Low

Repeat paragraph 2.3.1. with VL data

2.4. Test results

2.4.1. Vehicle High

Dates of tests	:	dd/mm/yyyy (wind tunnel) dd/mm/yyyy (dynamometer) or dd/mm/yyyy (on road)
----------------	---	--

On road

Method of the test	:	coastdown or torque meter method
Facility (name / location / track's reference)	:	
Coastdown mode	:	y/n
Wheel alignment	:	Toe and camber values
Ground clearance	:	
Vehicle height	:	
Drivetrain lubricants	:	
Wheel bearing lubricants	:	
Brake adjustment to avoid unrepresentative parasitic drag	:	
Maximum reference speed (km/h)	:	
Anemometry	:	stationary or on board: influence of anemometry ($C_D \times A$) and if it was corrected.

Number of split(s)	:	
Wind	:	average, peaks and direction in conjunction with direction of the test track
Air pressure	:	
Temperature (mean value)	:	
Wind correction	:	y/n
Tyre pressure adjustment	:	y/n
Raw results	:	Torque method: $c_0 =$ $c_1 =$ $c_2 =$ Coastdown method: f_0 f_1 f_2
Final results	:	Torque method: $c_0 =$ $c_1 =$ $c_2 =$ and $f_0 =$ $f_1 =$ $f_2 =$ Coastdown method: $f_0 =$ $f_1 =$ $f_2 =$

Or

Wind tunnel method

Facility (name/location/dynamometer's reference)	:							
Qualification of the facilities	:	Report reference and date						
Dynamometer								
Type of dynamometer	:	flat belt or chassis dynamometer						
Method	:	stabilised speeds or deceleration method						
Warm up	:	warm-up by dyno or by driving the vehicle						
Correction of the roller curve	:	(for chassis dynamometer, if applicable)						
Method of chassis dynamometer setting	:	Fixed run / iterative / alternative with its own warmup cycle						
Measured aerodynamic drag coefficient multiplied by the frontal area	:	<table border="1"> <thead> <tr> <th>Velocity (km/h)</th> <th>$C_D \times A$ (m²)</th> </tr> </thead> <tbody> <tr> <td>...</td> <td>...</td> </tr> <tr> <td>...</td> <td>...</td> </tr> </tbody> </table>	Velocity (km/h)	$C_D \times A$ (m ²)
Velocity (km/h)	$C_D \times A$ (m ²)							
...	...							
...	...							
Result	:	$f_0 =$ $f_1 =$ $f_2 =$						

Or

Road load matrix on road

Method of the test	:	coastdown or torque meter method
Facility (name/location/track's reference)	:	
Coastdown mode	:	y/n
Wheel alignment	:	Toe and camber values
Ground clearance	:	
Vehicle height	:	
Drivetrain lubricants	:	
Wheel bearing lubricants	:	
Brake adjustment to avoid unrepresentative parasitic drag	:	
Maximum reference speed (km/h)	:	
Anemometry	:	stationary or on board: influence of anemometry ($C_D \times A$) and if it was corrected.
Number of split(s)	:	
Wind	:	average, peaks and direction in conjunction with direction of the test track
Air pressure	:	
Temperature (mean value)	:	
Wind correction	:	y/n
Tyre pressure adjustment	:	y/n
Raw results	:	Torque method: $c_{0r} =$ $c_{1r} =$ $c_{2r} =$ Coastdown method: $f_{0r} =$ $f_{1r} =$ $f_{2r} =$
Final results	:	Torque method: $c_{0r} =$ $c_{1r} =$ $c_{2r} =$ and f_{0r} (calculated for vehicle H_M) = f_{2r} (calculated for vehicle H_M) = f_{0r} (calculated for vehicle L_M) = f_{2r} (calculated for vehicle L_M) = Coastdown method: f_{0r} (calculated for vehicle H_M) = f_{2r} (calculated for vehicle H_M) = f_{0r} (calculated for vehicle L_M) = f_{2r} (calculated for vehicle L_M) =

Or

Road load matrix wind tunnel method

Facility (name/location/dynamometer's reference)	:							
Qualification of the facilities	:	Report reference and date						
Dynamometer								
Type of dynamometer	:	flat belt or chassis dynamometer						
Method	:	stabilised speeds or deceleration method						
Warm up	:	warm-up by dyno or by driving the vehicle						
Correction of the roller curve	:	(for chassis dynamometer, if applicable)						
Method of chassis dynamometer setting	:	Fixed run / iterative / alternative with its own warmup cycle						
Measured aerodynamic drag coefficient multiplied by the frontal area	:	<table border="1"> <tr> <th>Velocity (km/h)</th> <th>$C_D \times A$ (m²)</th> </tr> <tr> <td>...</td> <td>...</td> </tr> <tr> <td>...</td> <td>...</td> </tr> </table>	Velocity (km/h)	$C_D \times A$ (m ²)
		Velocity (km/h)	$C_D \times A$ (m ²)					
						
...	...							
Result	:	$f_{0r} =$ $f_{1r} =$ $f_{2r} =$ f_{0r} (calculated for vehicle H_M) = f_{2r} (calculated for vehicle H_M) = f_{0r} (calculated for vehicle L_M) = f_{2r} (calculated for vehicle L_M) =						

2.4.2. Vehicle Low

Repeat paragraph 2.4.1. with VL data

Appendix 3

WLTP Test Sheet

Template for Test Sheet

The test sheet shall include the test data that are recorded, but not included in any test report.

The test sheet(s) shall be retained by the technical service or the manufacturer for at least 10 years.

The following information, if applicable, is the minimum data required for test sheets.

Information from Annex B4 to this Regulation																												
Adjustable wheel alignment parameters	:																											
Ground clearance	:																											
Vehicle height	:																											
Drivetrain lubricants	:																											
Wheel bearing lubricants	:																											
Brake adjustment to avoid unrepresentative parasitic drag	:																											
The coefficients, c_0 , c_1 and c_2 ,	:	$c_0 =$ $c_1 =$ $c_2 =$																										
The coastdown times measured on the chassis dynamometer	:	<table border="1"> <thead> <tr> <th>Reference speed (km/h)</th> <th>Coastdown time (s)</th> </tr> </thead> <tbody> <tr><td>130</td><td></td></tr> <tr><td>120</td><td></td></tr> <tr><td>110</td><td></td></tr> <tr><td>100</td><td></td></tr> <tr><td>90</td><td></td></tr> <tr><td>80</td><td></td></tr> <tr><td>70</td><td></td></tr> <tr><td>60</td><td></td></tr> <tr><td>50</td><td></td></tr> <tr><td>40</td><td></td></tr> <tr><td>30</td><td></td></tr> <tr><td>20</td><td></td></tr> </tbody> </table>	Reference speed (km/h)	Coastdown time (s)	130		120		110		100		90		80		70		60		50		40		30		20	
Reference speed (km/h)	Coastdown time (s)																											
130																												
120																												
110																												
100																												
90																												
80																												
70																												
60																												
50																												
40																												
30																												
20																												
Additional weight may be placed on or in the vehicle to eliminate tyre slippage	:	weight (kg) on/in the vehicle																										
The coastdown times after performing the vehicle coast down procedure	:	<table border="1"> <thead> <tr> <th>Reference speed (km/h)</th> <th>Coastdown time (s)</th> </tr> </thead> <tbody> <tr><td>130</td><td></td></tr> <tr><td>120</td><td></td></tr> <tr><td>110</td><td></td></tr> <tr><td>100</td><td></td></tr> <tr><td>90</td><td></td></tr> <tr><td>80</td><td></td></tr> </tbody> </table>	Reference speed (km/h)	Coastdown time (s)	130		120		110		100		90		80													
Reference speed (km/h)	Coastdown time (s)																											
130																												
120																												
110																												
100																												
90																												
80																												

		70	
		60	
		50	
		40	
		30	
		20	
Information from Annex B5 to this Regulation			
<u>NOx converter efficiency</u> Indicated concentrations (a); (b), (c), (d), and the concentration when the NOx analyser is in the NO mode so that the calibration gas does not pass through the converter	:	(a) = (b) = (c) = (d) = Concentration in NO mode =	
Information from Annex B6 to this Regulation			
The distance actually driven by the vehicle	:		
For manual shift transmission vehicle, MT vehicle that cannot follow the cycle trace: The deviations from the driving cycle	:		
<u>Drive trace indices:</u> The following indices shall be calculated in accordance with the standard SAE J2951(Revised Jan-2014): IWR : Inertial Work Rating RMSSE : Root Mean Squared Speed Error	:		
<u>Particulate sample filter weighing</u> Filter before the test Filter after the test Reference filter	:		
Content of each of the compounds measured after stabilization of the measuring device	:		
<u>Regeneration factor determination</u> The number of cycles D between two WLTCs where regeneration events occur The number of cycles over which emission measurements are made n The mass emissions measurement M_{sij} for each compound i over each cycle j	:		
<u>Regeneration factor determination</u> The number of applicable test cycles d measured for complete regeneration	:		
<u>Regeneration factor determination</u> Msi Mpi Ki	:		
Information from Annex B6a to this Regulation			
<u>ATCT</u>		Temperature set point = T_{reg} Actual temperature value ± 3 °C at the start of the test	

The air temperature and humidity of the test cell measured at the vehicle cooling fan outlet at a minimum frequency of 0.1 Hz.		± 5 °C during the test
The temperature of the soak area measured continuously at a minimum frequency of 0.033 Hz.	:	Temperature set point = T_{reg} Actual temperature value ± 3 °C at the start of the test ± 5 °C during the test
The time of transfer from the preconditioning to the soak area	:	≤ 10 minutes
The time between the end of the Type 1 test and the cool down procedure The measured soaking time, and shall be recorded in all relevant test sheets.	:	≤ 10 minutes : time between the measurement of the end temperature and the end of the Type 1 test at 23 °C
Information from Annex C3 to this Regulation		
<u>Diurnal testing</u> Ambient temperature during the two diurnal cycles (recorded at least every minute)	:	
<u>Carbon canister puff loss loading</u> Ambient temperature during the first 11-hour profile (recorded at least every 10 minutes)	:	

Appendix 4

Evaporative Emissions Test Report

The following information, if applicable, is the minimum data required for the evaporative emission test.

Report number

APPLICANT			
Manufacturer			
SUBJECT	...		
Evaporative family identifier	:		
Object submitted to tests			
	Make	:	
CONCLUSION	The object submitted to tests complies with the requirements mentioned in the subject.		

PLACE,	DD/MM/YYYY
--------	------------

Every Technical Service is free to include additional information

1. Description of tested vehicle high

Vehicle numbers	:	Prototype number and VIN
Category	:	

1.1. Powertrain architecture

Powertrain architecture	:	internal combustion, hybrid, electric or fuel cell
-------------------------	---	--

1.2. Internal combustion engine

For more than one ICE, please repeat the point

Make	:	
Type	:	
Working principle	:	two/four stroke
Cylinders number and arrangement	:	
Engine capacity (cm ³)	:	
Supercharging	:	yes/no
Direct injection	:	yes/no or description
Vehicle fuel type	:	Monofuel / bifuel / flex fuel
Engine lubricant	:	Make and type
Cooling system	:	Type: air/water/oil

1.4. Fuel system

Injection pump	:	
Injector(s)	:	
Fuel tank		
Layer(s)	:	monolayer/ multilayer
Material for the fuel tank	:	metal / ...
Material for other parts of the fuel system	:	...

Sealed	:	yes/no
Nominal tank capacity (l)	:	
Carbon canister		
Make and type	:	
Type of activated carbon	:	
Volume of charcoal (l)	:	
Mass of charcoal (g)	:	
Declared BWC (g)	:	xx.x

2. Test results

2.1. Carbon canister bench ageing

Date of tests	:	(day/month/year)
Place of the test	:	
Carbon canister ageing test report	:	
Loading rate	:	
Fuel specification		
Make	:	
Type	:	name of reference fuel...
Density at 15°C (kg/m ³)	:	
Ethanol content (%)	:	
Batch number	:	

2.2. Determination of the permeability factor (PF)

Date of tests	:	(day/month/year)
Place of the test	:	
Permeability factor test report	:	
HC measured at week 3, HC _{3w} (mg/24h)	:	xxx
HC measured at week 20, HC _{20w} (mg/24h)	:	xxx
Permeability Factor, PF (mg/24h)	:	xxx

In case of multilayer tanks or metal tanks

Alternative Permeability Factor, PF (mg/24h)	:	yes/no
--	---	--------

2.3. Evaporative test

Date of tests	:	(day/month/year)
Place of the test	:	
Method of chassis dyno setting	:	Fixed run / iterative / alternative with its own warmup cycle
Dynamometer operation mode	:	yes/no
Coastdown mode	:	yes/no

2.3.1. Mass

Test mass of VH (kg)	:	
----------------------	---	--

2.3.2. Roadload parameters

f ₀ (N)	:	
f ₁ (N/(km/h))	:	
f ₂ (N/(km/h) ²)	:	

2.3.3. Cycle and Gear shift point (if applicable)

Cycle (without downscaling)	:	Class 1 / 2 / 3
Gear shifting	:	Average gear for v ≥ 1 km/h, rounded to four places of decimal

2.3.4. Vehicle

Tested vehicle	:	VH or description
Mileage (km)	:	
Age (weeks)	:	

2.3.5. Procedure of test and results

Test procedure	:	Continuous (sealed fuel tank systems) / Continuous (non-sealed fuel tank systems) / Stand –alone (sealed fuel tank systems)
Description of soak periods (time and temperature)	:	
Puff loss loading value (g)	:	xx.x (if applicable)

Evaporative test	hot soak, M _{HS}	1st 24h diurnal, M _{D1}	2nd 24h diurnal, M _{D2}
Mean temperature (°C)		-	-
Evaporative emission (g/test)	x.xxx	x.xxx	x.xxx
Final result, M _{HS} +M _{D1} +M _{D2} +(2xPF) (g/test)	x.xx		

Annex A2

Communication

(maximum format: A4 (210 x 297 mm))

issued by: Name of administration:



- Concerning:²
- Approval granted
 - Approval extended
 - Approval refused
 - Approval withdrawn
 - Production definitively discontinued

of a vehicle type with regard to the emission of gaseous pollutants by the engine pursuant to UN Regulation No. WLTP

Approval No.

Reason for extension:.....

Section I

- 0.1. Make (trade name of manufacturer):
- 0.2. Type:
- 0.2.1. Commercial name(s) (if available):
- 0.3. Means of identification of type if marked on the vehicle³
- 0.3.1. Location of that marking:
- 0.4. Category of vehicle:⁴
- 0.5. Name and address of manufacturer:
- 0.8. Name(s) and address(es) of assembly plant(s):
- 0.9. If applicable, name and address of manufacturer's representative:
- 1.0. Remarks: ...

Section II

- 1. Additional information (where applicable): (see addendum)
- 2. Technical Service responsible for carrying out the tests:
- 3. Date of Type 1 test report:
- 4. Number of Type 1 test report:
- 5. Remarks (if any): (see Section 3 of addendum)

- 6. Place:
- 7. Date:
- 8. Signature:.....

- Attachments: 1. Information package.
2. Test reports.

Addendum to type approval communication No ... concerning the type approval of a vehicle with regard to exhaust emissions pursuant to the 01 series of amendments to UN Regulation No. [XXX]

- 0. INTERPOLATION FAMILY IDENTIFIER AS DEFINED IN PARAGRAPH 5. OF UN REGULATION NO. [xxx]**
 - 0.1. Identifier: ...
 - 0.2. Base vehicle identifier (^{5a}) (¹): ...
- 1. ADDITIONAL INFORMATION**
 - 1.1. Mass of the vehicle in running order:
 - VL (¹): ...
 - VH: ...
 - 1.2. Maximum mass:
 - VL (¹): ...
 - VH: ...
 - 1.3. Reference mass:
 - VL (¹): ...
 - VH: ...
 - 1.4. Number of seats: ...
 - 1.6. Type of bodywork:
 - 1.6.1. for M1, M2: saloon, hatchback, station wagon, coupé, convertible, multipurpose vehicle^(a)
 - 1.6.2. for N1, N2: lorry, van^(a)
 - 1.7. Drive wheels: front, rear, 4 × 4^(a)
 - 1.8. Pure electric vehicle: yes/no^(a)
 - 1.9. Hybrid electric vehicle: yes/no^(a)
 - 1.9.1. Category of Hybrid Electric vehicle: Off Vehicle Charging/Not Off Vehicle charging / Off Vehicle Charging Fuel Cell / Not Off Vehicle Charging Fuel Cell (as applicable)^(a)
 - 1.9.2. Operating mode switch: with/without^(a)
 - 1.10. Engine identification:
 - 1.10.1. Engine capacity/displacement (as applicable)
 - 1.10.1.1. Reciprocating engine:
 - 1.10.1.2. Wankel engine
 - 1.10.1.2.1. Capacity:
 - 1.10.1.2.2. Displacement:
 - 1.10.2. Fuel supply system: direct injection/indirect injection^(a)
 - 1.10.3. Fuel recommended by the manufacturer:
 - 1.10.4.1. Maximum power: kW at min⁻¹
 - 1.10.4.2. Maximum torque: Nm at min⁻¹

- 1.10.5. Pressure charging device: yes/no^(a)
- 1.10.6. Ignition system: compression ignition/positive ignition^(a)
- 1.11. Power train (for pure electric vehicle or hybrid electric vehicle) ^(a)
- 1.11.1. Maximum net power: ... kW, at: ... to ... min⁻¹
- 1.11.2. Maximum thirty minutes power: ... kW
- 1.11.3. Maximum net torque: ... Nm, at ... min⁻¹
- 1.12. Traction battery (for pure electric vehicle or hybrid electric vehicle)
- 1.12.1. Nominal voltage: V
- 1.12.2. Capacity (2 h rate): Ah
- 1.13. Transmission: ..., ...
- 1.13.1. Type of gearbox: manual/automatic/variable transmission^(a)
- 1.13.2. Number of gear ratios:
- 1.13.3. Total gear ratios (including the rolling circumferences of the tyres under load):
(vehicle speed (km/h)) / (engine speed (1000 (min⁻¹)))

First gear: ...	Sixth gear: ...
Second gear: ...	Seventh gear: ...
Third gear: ...	Eighth gear: ...
Fourth gear: ...	Overdrive: ...
Fifth gear: ...	

- 1.13.4. Final drive ratio:
- 1.14. Tyres: ..., ..., ...
Type: radial/bias/...⁴
Dimensions: ...
Rolling circumference under load:
Rolling circumference of tyres used for the Type 1 test

2. TEST RESULTS

2.1. Tailpipe emissions test results

- Emissions classification: ...
- Type 1 test results, where applicable
- Type approval number if not parent vehicle (¹): ...

Test 1

Type 1 Result	CO (mg/km)	THC (mg/km)	NMHC (mg/km)	NO _x (mg/km)	THC + NO _x (mg/km)	PM (mg/km)	PN (#.10 ¹¹ /km)
Measured ⁽⁸⁾ ⁽⁹⁾							
Ki × ⁽⁸⁾ ⁽¹⁰⁾					⁽¹¹⁾		
Ki + ⁽⁸⁾ ⁽¹⁰⁾					⁽¹¹⁾		
Mean value calculated with Ki (M × Ki or M + Ki) ⁽⁹⁾					⁽¹²⁾		
DF (+) ⁽⁸⁾ ⁽¹⁰⁾							
DF (×) ⁽⁸⁾ ⁽¹⁰⁾							
Final mean value calculated with Ki and DF ⁽¹³⁾							
Limit value							

Test 2 (if applicable)

Repeat Test 1 table with the second test results.

Test 3 (if applicable)

Repeat Test 1 table with the third test results.

Repeat Test 1, test 2 (if applicable) and test 3 (if applicable) for Vehicle Low (if applicable), and VM (if applicable)

ATCT test

CO ₂ Emission (g/km)	Combined
ATCT (14 °C) M _{CO2,Treg}	
Type 1 (23 °C) M _{CO2,23°}	
Family correction factor (FCF)	

ATCT test Result	CO (mg/km)	THC (mg/km)	NMHC (mg/km)	NO _x (mg/km)	THC + NO _x (mg/km)	PM (mg/km)	PN (#.10 ¹¹ /km)
Measured ⁵⁶							
Limit values							

Difference between engine coolant end temperature and average soak area temperature of the last 3 hours ΔT_{ATCT} (°C) for the reference vehicle: ...

The minimum soaking time t_{soak_ATCT} (s): ...

Location of temperature sensor: ...

ATCT family identifier: ...

Type 4: ... g/test;

Test procedure in accordance with: Annex C3 to UN Regulation No. [xxx] ⁽¹⁾.

Type 5:

- Durability test: whole vehicle test/bench ageing test/none ⁽¹⁾
- Deterioration factor DF: calculated/assigned ⁽¹⁾
- Specify the values: ...
- Applicable Type 1 cycle (Annex B4 to UN Regulation No. [xxx] ⁽¹⁴⁾): ...

2.1.1. For bi fuel vehicles, the type 1 table shall be repeated for both fuels. For flex fuel vehicles, when the type 1 test is to be performed on both fuels according to Table A in paragraph 6. of UN Regulation No. [xxx], and for vehicles running on LPG or NG/Biomethane, either mono fuel or bi fuel, the table shall be repeated for the different reference gases used in the test, and an additional table shall display the worst results obtained.

2.1.2. Written description and/or drawing of the MI: ...

2.1.3. List and function of all components monitored by the OBD system: ...

2.1.4. Written description (general working principles) for: ...

2.1.4.1. Misfire detection⁷: ...

2.1.4.2. Catalyst monitoring⁸: ...

2.1.4.3. Oxygen sensor monitoring⁹: ...

2.1.4.4. Other components monitored by the OBD system¹⁰: ...

- 2.1.4.5. Catalyst monitoring¹¹: ...
- 2.1.4.6. Particulate trap monitoring¹²: ...
- 2.1.4.7. Electronic fuelling system actuator monitoring¹³: ...
- 2.1.4.8. Other components monitored by the OBD system: ...
- 2.1.5. Criteria for MI activation (fixed number of driving cycles or statistical method): ...
- 2.1.6. List of all OBD output codes and formats used (with explanation of each): ...
- 2.2. Reserved**
- 2.3. Catalytic converters yes/no^(a)**
- 2.3.1. Original equipment catalytic converter tested to all relevant requirements of this UN Regulation yes/no^(a)
- 2.5. CO₂ emissions and fuel consumption test results**
- 2.5.1. *Pure ICE vehicle and Not Externally Chargeable (NOVC) Hybrid Electric Vehicle*
- 2.5.1.0. Minimum and maximum CO₂ values within the interpolation family: ...
- 2.5.1.1. Vehicle High
- 2.5.1.1.1. Cycle Energy Demand: ... J
- 2.5.1.1.2. Road load coefficients
- 2.5.1.1.2.1. f_0, N : ...
- 2.5.1.1.2.2. $f_1, N/(km/h)$: ...
- 2.5.1.1.2.3. $f_2, N/(km/h)^2$: ...
- 2.5.1.1.3. CO₂ mass emissions (provide values for each reference fuel tested, for the phases: the measured values, for the combined see points 1.2.3.8. and 1.2.3.9. of Annex B6 to UN Regulation No. [xxx])

CO ₂ Emission (g/km)	Test	Low	Medium	High	Extra High	Combined
$M_{CO_2,p,5} / M_{CO_2,e,5}$	1					
	2					
	3					
	average					
Final $M_{CO_2,p,H} / M_{CO_2,e,H}$						

2.5.1.1.4. Fuel consumption (provide values for each reference fuel tested, for the phases: the measured values for the combined see paragraphs 1.2.3.8 and 1.2.3.9 of Annex B6 to UN Regulation No. [xxx])

Fuel consumption (l/100 km or m ³ /100 km or kg/100 km) ⁽¹⁾ or fuel efficiency (km/l or km/kg) ⁽¹⁾ (as applicable)	Low	Medium	High	Extra High	Combined
Final values FC _{p,H} /FC _{c,H} or FE _{p,H} , FE _{c,H}					

2.5.1.2. Vehicle Low (if applicable)

2.5.1.2.1. Cycle Energy Demand: ... J

2.5.1.2.2. Road load coefficients

2.5.1.2.2.1. f₀, N: ...

2.5.1.2.2.2. f₁, N/(km/h): ...

2.5.1.2.2.3. f₂, N/(km/h) ⁽²⁾: ...

2.5.1.2.3. CO₂ mass emissions (provide values for each reference fuel tested, for the phases: the measured values for the combined see points 1.2.3.8. and.1.2.3.9. of Annex B6 to UN Regulation No. [xxx])

CO ₂ Emission (g/km)	Test	Low	Medium	High	Extra High	Combined
M _{CO₂,p,5} /M _{CO₂,c,5}	1					
	2					
	3					
	average					
Final M _{CO₂,p,L} /M _{CO₂,c,L}						

2.5.1.2.4. Fuel consumption (provide values for each reference fuel tested, for the phases: the measured values for the combined see points 1.2.3.8 and 1.2.3.9 of Annex B6 to UN Regulation No. [xxx])

Fuel consumption (l/100 km or m ³ /100 km or kg/100 km) ⁽¹⁾ or fuel efficiency (km/l or km/kg) ⁽¹⁾ (as applicable)	Low	Medium	High	Extra High	Combined
Final values FC _{p,L} /FC _{c,L} or , FE _{p,L} , FE _{c,L}					

2.5.1.3. Vehicle M for NOVC-HEV (if applicable)

2.5.1.3.1. Cycle Energy Demand: ... J

2.5.1.3.2. Road load coefficients

2.5.1.3.2.1. f₀, N: ...

2.5.1.3.2.2. f₁, N/(km/h): ...

2.5.1.3.2.3. f₂, N/(km/h) ⁽²⁾: ...

- 2.5.1.3.3. CO₂ mass emissions (provide values for each reference fuel tested, for the phases: the measured values for the combined see paragraphs 1.2.3.8. and 1.2.3.9. of Annex B6 to UN Regulation No. [xxx])

CO ₂ Emission (g/km)	Test	Low	Medium	High	Extra High	Combined
M _{CO₂,p,5} /M _{CO₂,c,5}	1					
	2					
	3					
	average					
Final M _{CO₂,p,L} /M _{CO₂,c,L}						

- 2.5.1.3.4. Fuel consumption (provide values for each reference fuel tested, for the phases: the measured values for the combined see paragraphs 1.2.3.8. and 1.2.3.9. of Annex B6 to UN Regulation No. [xxx])

Fuel consumption (l/100 km or m ³ /100 km or kg/100 km) ⁽¹⁾ or fuel efficiency (km/l or km/kg) ⁽¹⁾ (as applicable)	Low	Medium	High	Extra High	Combined
Final values FC _{p,L} / FC _{c,L} or , FE _{p,L} , FE _{c,L}					

- 2.5.1.4. For vehicles powered by an internal combustion engine which are equipped with periodically regenerating systems as defined in paragraph 3.8.1. of UN Regulation No. [xxx], the test results shall be adjusted by the Ki factor as specified in Appendix 1 to Annex B6 of UN Regulation No. [xxx].

- 2.5.1.4.1. Information about regeneration strategy for CO₂ emissions and fuel consumption

D — number of operating cycles between 2 cycles where regenerative phases occur: ...

d — number of operating cycles required for regeneration: ...

Applicable Type 1 cycle (Annex B4 to UN Regulation No. [xxx]) ⁽¹⁴⁾: ...

	Combined
Ki (additive / multiplicative) ⁽¹⁾	
Values for CO ₂ and fuel consumption ⁽¹⁰⁾	

- 2.5.2. *Pure electric vehicles*¹⁴

- 2.5.2.1. Electric energy consumption

- 2.5.2.1.1. Vehicle High

- 2.5.2.1.1.1. Cycle Energy Demand: ... J

- 2.5.2.1.1.2. Road load coefficients

- 2.5.2.1.1.2.1. f₀, N: ...

2.5.2.1.1.2.2. f_1 , N/(km/h): ...

2.5.2.1.1.2.3. f_2 , N/(km/h) (2): ...

E _{AC} (Wh)	Test	
	1	
	2	
	3	

EC (Wh/km)	Test	(as applicable)					
		Low	Medium	High	Extra High	City	Combined
Calculated EC	1						
	2						
	3						
	average						
Declared value		—	—	—	—	—	

2.5.2.1.1.3. Total time out of tolerance for the conduct of the cycle: ... sec

2.5.2.1.2. Vehicle Low (if applicable)

2.5.2.1.2.1. Cycle Energy Demand: ... J

2.5.2.1.2.2. Road load coefficients

2.5.2.1.2.2.1. f_0 , N: ...

2.5.2.1.2.2.2. f_1 , N/(km/h): ...

2.5.2.1.2.2.3. f_2 , N/(km/h) (2): ...

E _{AC} (Wh)	Test	
	1	
	2	
	3	

EC (Wh/km)	Test	City	Combined
Calculated EC	1		
	2		
	3		
	average		
Declared value		—	

EC (Wh/km)	Test	Low	Medium	High	Extra High	City	Combined
Calculated EC	1						
	2						
	3						
	average						
Declared value		—	—	—	—	—	

2.5.2.1.2.3. Total time out of tolerance for the conduct of the cycle: ... sec

2.5.2.2. Pure Electric Range

2.5.2.2.1. Vehicle High

PER (km)	Test	Low	Medium	High	Extra High	City	Combined
Measured Pure Electric Range	1						
	2						
	3						
	average						
Declared value		—	—	—	—	—	

2.5.2.2.2. Vehicle Low (if applicable)

PER (km)	Test	Low	Medium	High	Extra High	City	Combined
Measured Pure Electric Range	1						
	2						
	3						

	average						
Declared value		—	—	—	—	—	

PER (km)	Test	City	Combined
Measured Pure Electric Range	1		
	2		
	3		
	average		
Declared value		—	

- 2.5.3. Externally chargeable (OVC) Hybrid Electric Vehicle and Fuel Cell Hybrid Vehicle (as applicable):
 - 2.5.3.1. CO₂ mass emission charge sustaining (only applicable for OVC-HEVs)
 - 2.5.3.1.1. Vehicle High
 - 2.5.3.1.1.1. Cycle Energy Demand: ... J
 - 2.5.3.1.1.2. Road load coefficients
 - 2.5.3.1.1.2.1. f₀, N: ...
 - 2.5.3.1.1.2.2. f₁, N/(km/h): ...
 - 2.5.3.1.1.2.3. f₂, N/(km/h) (²): ...

CO ₂ Emission (g/km)	Test	Low	Medium	High	Extra High	Combined
M _{CO2,p,5} /M _{CO2,c,5}	1					
	2					
	3					
	Average					
Final M _{CO2,p,H} /M _{CO2,c,H}						

- 2.5.3.1.2. Vehicle Low (if applicable)
 - 2.5.3.1.2.1. Cycle Energy Demand: ... J
 - 2.5.3.1.2.2. Road load coefficients
 - 2.5.3.1.2.2.1. f₀, N: ...
 - 2.5.3.1.2.2.2. f₁, N/(km/h): ...
 - 2.5.3.1.2.2.3. f₂, N/(km/h) (²): ...

CO ₂ Emission (g/km)	Test	Low	Medium	High	Extra High	Combined
M _{CO₂,p,5} /M _{CO₂,c,5}	1					
	2					
	3					
	Average					
Final M _{CO₂,p,L} /M _{CO₂,c,L}						

2.5.3.1.3. Vehicle M (if applicable)

2.5.3.1.3.1. Cycle Energy Demand: ... J

2.5.3.1.3.2. Road load coefficients

2.5.3.1.3.2.1. f_0 , N: ...

2.5.3.1.3.2.2. f_1 , N/(km/h): ...

2.5.3.1.3.2.3. f_2 , N/(km/h) (²): ...

CO ₂ Emission (g/km)	Test	Low	Medium	High	Extra High	Combined
M _{CO₂,p,5} /M _{CO₂,c,5}	1					
	2					
	3					
	Average					
M _{CO₂,p,M} /M _{CO₂,c,M}						

2.5.3.2. CO₂ mass emission charge depleting (only applicable for OVC-HEVs)

Vehicle High

CO ₂ Emission (g/km)	Test	Combined
M _{CO₂,CD}	1	
	2	
	3	
	Average	
Final M _{CO₂,CD,H}		

Vehicle Low (if applicable)

CO ₂ Emission (g/km)	Test	Combined
M _{CO₂,CD}	1	
	2	
	3	
	Average	
Final M _{CO₂,CD,L}		

Vehicle M (if applicable)

CO ₂ Emission (g/km)	Test	Combined
M _{CO₂,CD}	1	
	2	
	3	
	Average	
Final M _{CO₂,CD,M}		

2.5.3.3. CO₂ mass emission (weighted, combined)¹⁵ (only applicable for OVC-HEVs):

Vehicle High: M_{CO₂,weighted} ... g/km

Vehicle Low (if applicable): M_{CO₂,weighted} ... g/km

Vehicle M (if applicable): M_{CO₂,weighted} ... g/km

2.5.3.3.1. Minimum and maximum CO₂ values within the interpolation family.

2.5.3.4. Fuel consumption Charge Sustaining

Vehicle High					
Fuel consumption (l/100 km or m ³ /100 km or kg/100 km) ⁽¹⁾ or fuel efficiency (km/l or km/kg) ⁽¹⁾ (as applicable)	Low	Medium	High	Extra High	Combined
Final values FC _{p,H} / FC _{c,H} or FE _{p,H} , FE _{c,H}					

Vehicle Low (if applicable)					
Fuel consumption (l/100 km) or m ³ /100 km or kg/100 km) (1) or	Low	Medium	High	Extra High	Combined

fuel efficiency (km/l or km/kg) (1) (as applicable)					
Final values $FC_{p,L}$ / $FC_{c,L}$ or $FE_{p,L}$, $FE_{c,L}$					

Vehicle M (if applicable)					
Fuel consumption (l/100 km or $m^3/100$ km or kg/100 km) ⁽¹⁾ or fuel efficiency (km/l or km/kg) ⁽¹⁾ (as applicable)	Low	Medium	High	Extra High	Combined
Final values $FC_{p,M}$ / $FC_{c,M}$ or $FE_{p,M}$, $FE_{c,M}$					

2.5.3.5. Fuel consumption Charge Depleting

Vehicle High

Fuel consumption (l/100 km or $m^3/100$ km or kg/100 km) ⁽¹⁾ or fuel efficiency (km/l or km/kg) ⁽¹⁾ (as applicable)	Combined
Final values $FC_{CD,H}$ or $FE_{CD,H}$	

Vehicle Low (if applicable)

Fuel consumption (l/100 km or $m^3/100$ km or kg/100 km) ⁽¹⁾ or fuel efficiency (km/l or km/kg) ⁽¹⁾ (as applicable)	Combined
Final values $FC_{CD,L}$ or $FE_{CD,L}$	

Vehicle M (if applicable)

Fuel consumption (l/100 km or $m^3/100$ km or kg/100 km) ⁽¹⁾ or fuel efficiency (km/l or km/kg) ⁽¹⁾ (as applicable)	Combined
Final values $FC_{CD,M}$ or $FE_{CD,M}$	

2.5.3.6. Fuel consumption (weighted, combined)¹⁶:

Vehicle High: $FC_{weighted} \dots$ l/100 km or (kg/100/km); or $FE_{weighted} \dots$ km/l

Vehicle Low (if applicable): $FC_{weighted} \dots$ l/100 km or (kg/100/km); or $FE_{weighted} \dots$ km/l

Vehicle M (if applicable): $FC_{weighted} \dots$ l/100 km or (kg/100/km); or $FE_{weighted} \dots$ km/l

2.5.3.7. Ranges:

2.5.3.7.1. All Electric Range AER

AER (km)	Test	City	Combined
AER values	1		
	2		
	3		
	Average		
Final values AER			

2.5.3.7.2. Equivalent All Electric Range EAER (where applicable)

EAER (km)	Low	Medium	High	Extra High	City	Combined
EAER values						

2.5.3.7.3. Actual Charge Depleting Range R_{CDA}

R _{CDA} (km)	Combined
R _{CDA} values	

2.5.3.7.4. Charge Depleting Cycle Range R_{CDC}

R _{CDC} (km)	Test	Combined
R _{CDC} values	1	
	2	
	3	
	Average	
Final values R _{CDC}		

2.5.3.8. Electric energy consumption

2.5.3.8.1. Electric Energy Consumption EC

2.5.3.8.1. Recharged electric energy

EAC(Wh)	

EC (Wh/km)	Low	Medium	High	Extra High	City	Combined

Electric energy consumption values						
------------------------------------	--	--	--	--	--	--

2.5.3.8.2. UF-weighted charge-depleting electric energy consumption $EC_{AC,CD}$ (combined)

$EC_{AC,CD}$ (Wh/km)	Test	Combined
$EC_{AC,CD}$ values	1	
	2	
	3	
	Average	
Final values $EC_{AC,CD}$		

2.5.3.8.3. UF-weighted electric energy consumption $EC_{AC, weighted}$ (combined)

$EC_{AC,weighted}$ (Wh/km)	Test	Combined
$EC_{AC,weighted}$ values	1	
	2	
	3	
	Average	
Final values $EC_{AC,weighted}$		

Repeat 2.5.3. in case of base vehicle.

2.5.4. Not Off Vehicle Charging Fuel Cell Hybrid Vehicles (NOVC-FCHV)

Fuel Consumption (kg/100 km) or km/kg	Combined
Final values FC_c	

Repeat 2.5.4. in case of base vehicle.

2.5.5. Device for monitoring the consumption of fuel and/or electric energy: yes/not applicable ...

3. **Remarks: ...****Explanatory Notes**

⁽⁴⁾ If the means of identification of type contains characters not relevant to describe the vehicle, component or separate technical unit types covered by this information, such characters shall be represented in the documentation by the symbol '?' (e.g. ABC??123??)

⁽⁵⁾

^(5a)

- (⁶)
- (⁸) Where applicable.
- (⁹) Round to 2 decimal places
- (¹⁰) Round to 4 decimal places
- (¹¹) Not applicable
- (¹²) Mean value calculated by adding mean values (M.Ki) calculated for THC and NOx.
- (¹³) Round to 1 decimal place more than limit value.
- (¹⁴) Indicate the applicable procedure.
- (²²) Applicable Type 1 cycle: Annex B1 of UN Regulation No. [xxx]
- (²³) If modelling is applied instead of the type 1 test-cycle, this value shall be the one provided by the modelling methodology.
- (^a) Delete where not applicable (there are cases where nothing needs to be deleted when more than one entry is applicable)

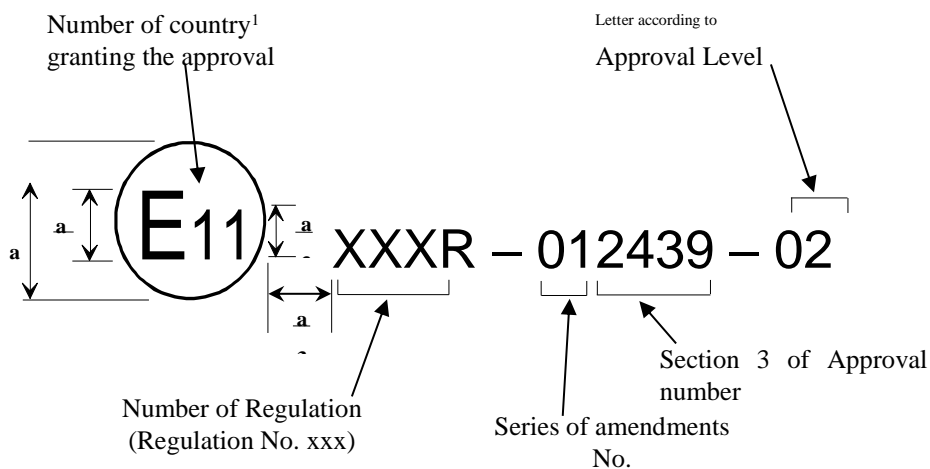
Annex A3

Arrangements of the approval mark

In the approval mark issued and affixed to a vehicle in conformity with paragraph 5. of this Regulation, the type approval number shall be accompanied by an alphanumeric character reflecting the level that the approval is limited to.

This annex outlines the appearance of this mark and gives an example how it shall be composed.

The following schematic graphic presents the general lay-out, proportions and contents of the marking. The meaning of numbers and alphabetical character are identified, and sources to determine the corresponding alternatives for each approval case are also referred.



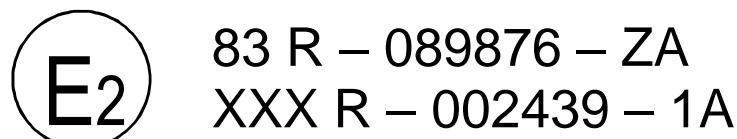
a = 8 mm (minimum)

The following graphic is a practical example of how the marking should be composed.



The preceding approval mark affixed to a vehicle in conformity with paragraph 5. of this Regulation shows that the vehicle type concerned has been approved in the United Kingdom (E 11), pursuant to this Regulation under Section 3 of the approval number 2439 as defined in paragraph 5.2.1. This mark indicates that the approval was given in accordance with the requirements of this Regulation with the 00 series of amendments incorporated. Furthermore, the accompanying code (1A) denotes that the vehicle is approved to Level 1A (Europe).

The following graphic is a practical example of how the marking should be composed.



The preceding approval mark affixed to a vehicle in conformity with paragraph 5. of this Regulation shows that the vehicle type concerned has been approved in France (E 2), pursuant to:

- Regulation 83 under section 3 of approval number 9876. This mark indicates that the approval was given in accordance with the requirements of this Regulation with the 08 series of amendments incorporated. Furthermore, the accompanying code (ZA) denotes that the vehicle is approved under the ZA character.
- this Regulation under section 3 of approval number 2439. This mark indicates that the approval was given in accordance with the requirements of this Regulation with the 00 series of amendments incorporated. Furthermore, the accompanying code (1A) denotes that the vehicle is approved to Level 1A (Europe).

Table A3/1

Characters with reference to approval level

<i>Code</i>	<i>Contracting Party on which the requirements are based</i>
1A	European Union
1B	Japan
02	Harmonized

Annexes Part B

The annexes in Annexes Part B describe the procedures for determining the levels of emissions of gaseous compounds, particulate matter, particle number (if PN measurement is required), CO₂ emissions, fuel consumption, electric energy consumption and electric range from light-duty vehicles.

Annex B1

Worldwide light-duty test cycles (WLTC)

1. General requirements

The cycle to be driven depends on the ratio of the test vehicle's rated power to mass in running order minus 75 kg, W/kg, and its maximum velocity, v_{\max} (as defined in paragraph 3.7.2. of this Regulation).

The cycle resulting from the requirements described in this annex shall be referred to in other parts of this Regulation as the "applicable cycle".
2. Vehicle classifications
 - 2.1. Class 1 vehicles have a power to mass in running order minus 75 kg ratio $P_{\text{mr}} \leq 22$ W/kg.
 - 2.2. Class 2 vehicles have a power to mass in running order minus 75 kg ratio > 22 but ≤ 34 W/kg.
 - 2.3. Class 3 vehicles have a power to mass in running order minus 75 kg ratio > 34 W/kg.
 - 2.3.1. Class 3 vehicles are divided into 2 subclasses according to their maximum speed, v_{\max} .
 - 2.3.1.1. Class 3a vehicles with $v_{\max} < 120$ km/h.
 - 2.3.1.2. Class 3b vehicles with $v_{\max} \geq 120$ km/h.
 - 2.3.2. All vehicles tested according to Annex B8 shall be considered to be Class 3 vehicles.
3. Test cycles
 - 3.1. Class 1 cycle
 - 3.1.1. A complete Class 1 cycle shall consist of a low phase (Low_1), a medium phase (Medium_1) and an additional low phase (Low_1).
 - 3.1.2. The Low_1 phase is described in Figure A1/1 and Table A1/1.
 - 3.1.3. The Medium_1 phase is described in Figure A1/2 and Table A1/2.
 - 3.2. Class 2 cycle
 - 3.2.1. A complete Class 2 cycle shall consist of a low phase (Low_2), a medium phase (Medium_2), a high phase (High_2) and an extra high phase (Extra High_2).
A 3-phase Class 2 cycle shall consist of a low phase (Low_2), a medium phase (Medium_2) and a high phase (High_2).
 - 3.2.2. The Low_2 phase is described in Figure A1/3 and Table A1/3.
 - 3.2.3. The Medium_2 phase is described in Figure A1/4 and Table A1/4.
 - 3.2.4. The High_2 phase is described in Figure A1/5 and Table A1/5.
 - 3.2.5. The Extra High_2 phase is described in Figure A1/6 and Table A1/6.
 - 3.3. Class 3 cycle

Class 3 cycles are divided into 2 subclasses to reflect the subdivision of Class 3 vehicles.

 - 3.3.1. Class 3a cycle
 - 3.3.1.1. A complete Class 3a cycle shall consist of a low phase (Low_3), a medium phase (Medium_{3a}), a high phase (High_{3a}) and an extra high phase (Extra High_3).

- A 3-phase Class 3a cycle shall consist of a low phase (Low_3), a medium phase ($Medium_{3a}$) and a high phase ($High_{3a}$).
- 3.3.1.2. The Low_3 phase is described in Figure A1/7 and Table A1/7.
- 3.3.1.3. The $Medium_{3a}$ phase is described in Figure A1/8 and Table A1/8.
- 3.3.1.4. The $High_{3a}$ phase is described in Figure A1/10 and Table A1/10.
- 3.3.1.5. The Extra $High_3$ phase is described in Figure A1/12 and Table A1/12.
- 3.3.2. Class 3b cycle
- 3.3.2.1. A complete Class 3b cycle shall consist of a low phase (Low_3) phase, a medium phase ($Medium_{3b}$), a high phase ($High_{3b}$) and an extra high phase ($Extra\ High_3$).
A 3-phase Class 3b cycle shall consist of a low phase (Low_3) phase, a medium phase ($Medium_{3b}$) and a high phase ($High_{3b}$).
- 3.3.2.2. The Low_3 phase is described in Figure A1/7 and Table A1/7.
- 3.3.2.3. The $Medium_{3b}$ phase is described in Figure A1/9 and Table A1/9.
- 3.3.2.4. The $High_{3b}$ phase is described in Figure A1/11 and Table A1/11.
- 3.3.2.5. The Extra $High_3$ phase is described in Figure A1/12 and Table A1/12.
- 3.4. Duration of the cycle phases
- 3.4.1. Class 1 cycle.
- The first low speed phase starts at second 0 (t_{start_low1}) and ends at second 589 (t_{end_low1} , duration 589 s)
- The medium speed phase starts at second 589 ($t_{start_medium1}$) and ends at second 1022 ($t_{end_medium1}$, duration 433 s)
- The second low speed phase starts at second 1022 (t_{start_low2}) and ends at second 1611 (t_{end_low2} , duration 589 s)
- 3.4.2. Class 2 and class 3 cycles.
- The low speed phase starts at second 0 (t_{start_low2} , t_{start_low3}) and ends at second 589 (t_{end_low2} , t_{end_low3} , duration 589 s)
- The medium speed phase starts at second 589 ($t_{start_medium2}$, $t_{start_medium3}$) and ends at second 1022 ($t_{end_medium2}$, $t_{end_medium3}$, duration 433 s)
- The high speed phase starts at second 1022 (t_{start_high2} , t_{start_high3}) and ends at second 1477 (t_{end_high2} , t_{end_high3} , duration 455 s)
- The extra high speed phase starts at second 1477 ($t_{start_exhigh2}$, $t_{start_exhigh3}$) and ends at second 1800 ($t_{end_exhigh2}$, $t_{end_exhigh3}$, duration 323 s)
- 3.5. WLTC city cycles
- OVC-HEVs and PEVs shall be tested using the appropriate Class 3a and Class 3b WLTC and WLTC city cycles (see Annex B8).
- The WLTC city cycle consists of the low and medium speed phases only.
4. WLTC Class 1 cycle

Figure A1/1
WLTC, Class 1 cycle, phase Low₁₁

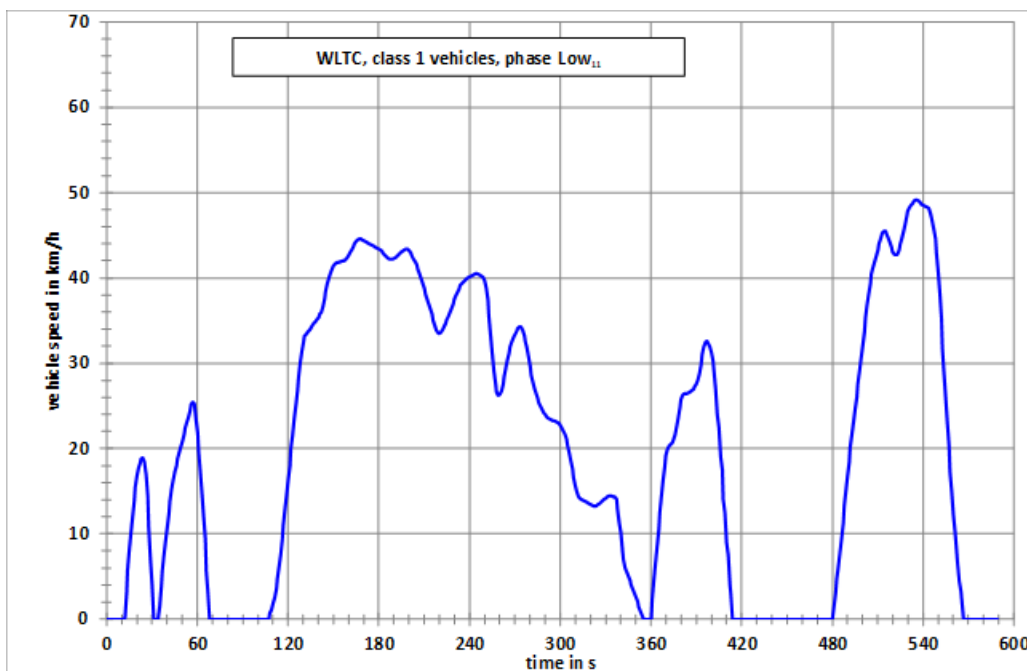


Figure A1/2a
WLTC, Class 1 cycle, phase Medium₁

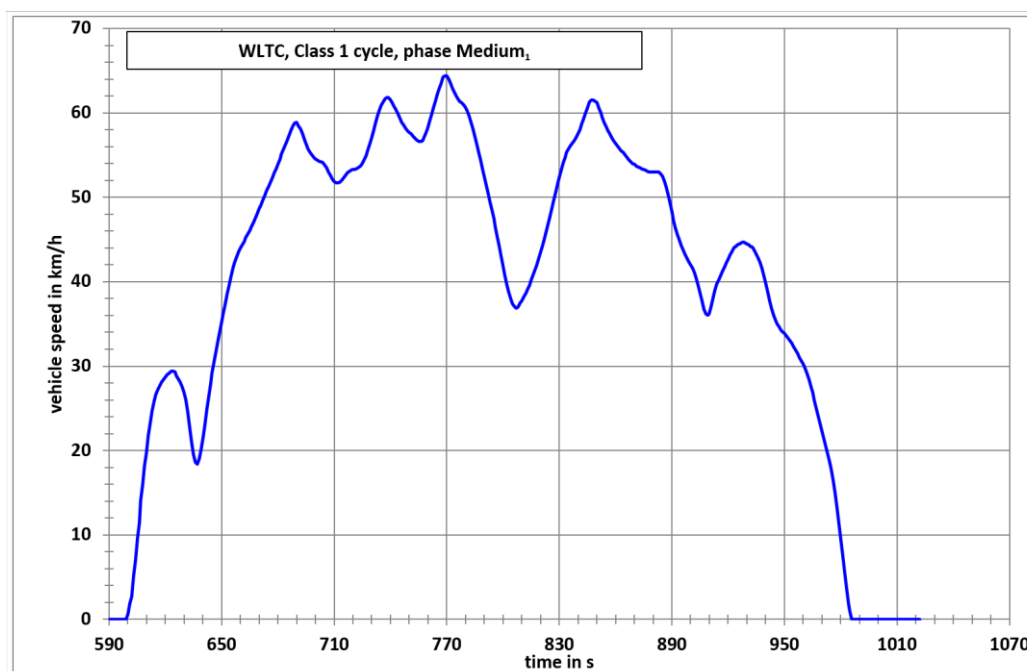


Figure A1/2b
WLTC, Class 1 cycle, phase Low₁₂

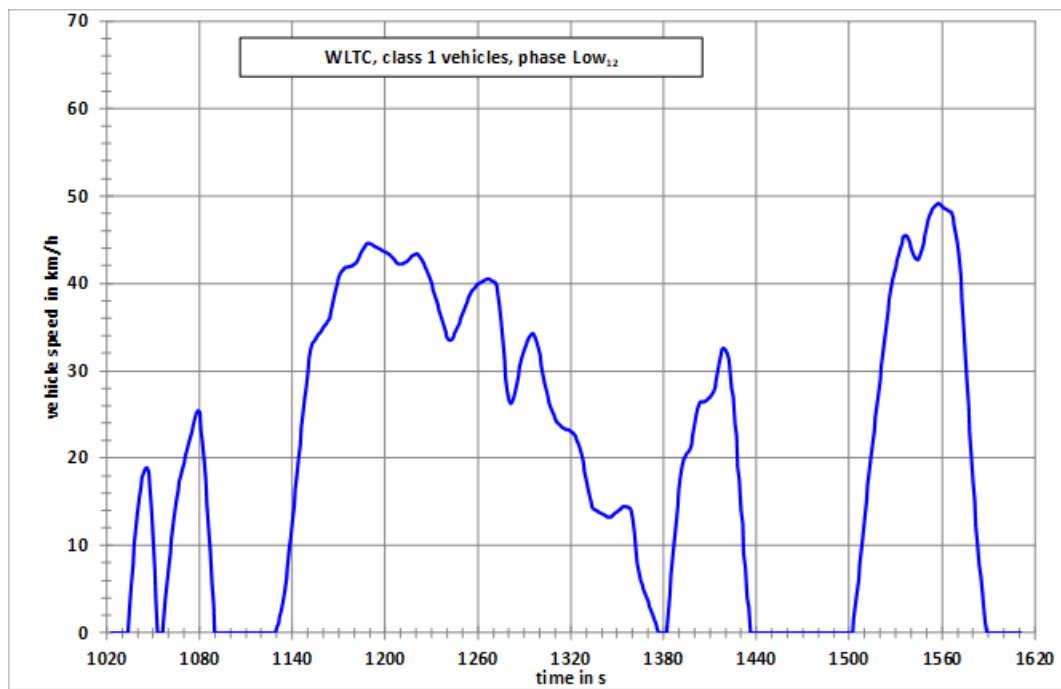


Table A1/1

WLTC, Class 1 cycle, phase Low₁₁ (Second 589 is the end of phase Low₁₁ and the start of phase Medium₁)

<i>Time in s</i>	<i>Speed in km/h</i>	<i>Time in s</i>	<i>Speed in km/h</i>	<i>Time in s</i>	<i>Speed in km/h</i>	<i>Time in s</i>	<i>Speed in km/h</i>
0	0.0	47	18.8	94	0.0	141	35.7
1	0.0	48	19.5	95	0.0	142	35.9
2	0.0	49	20.2	96	0.0	143	36.6
3	0.0	50	20.9	97	0.0	144	37.5
4	0.0	51	21.7	98	0.0	145	38.4
5	0.0	52	22.4	99	0.0	146	39.3
6	0.0	53	23.1	100	0.0	147	40.0
7	0.0	54	23.7	101	0.0	148	40.6
8	0.0	55	24.4	102	0.0	149	41.1
9	0.0	56	25.1	103	0.0	150	41.4
10	0.0	57	25.4	104	0.0	151	41.6
11	0.0	58	25.2	105	0.0	152	41.8
12	0.2	59	23.4	106	0.0	153	41.8
13	3.1	60	21.8	107	0.0	154	41.9
14	5.7	61	19.7	108	0.7	155	41.9
15	8.0	62	17.3	109	1.1	156	42.0
16	10.1	63	14.7	110	1.9	157	42.0
17	12.0	64	12.0	111	2.5	158	42.2
18	13.8	65	9.4	112	3.5	159	42.3
19	15.4	66	5.6	113	4.7	160	42.6
20	16.7	67	3.1	114	6.1	161	43.0
21	17.7	68	0.0	115	7.5	162	43.3
22	18.3	69	0.0	116	9.4	163	43.7
23	18.8	70	0.0	117	11.0	164	44.0
24	18.9	71	0.0	118	12.9	165	44.3
25	18.4	72	0.0	119	14.5	166	44.5
26	16.9	73	0.0	120	16.4	167	44.6
27	14.3	74	0.0	121	18.0	168	44.6
28	10.8	75	0.0	122	20.0	169	44.5
29	7.1	76	0.0	123	21.5	170	44.4
30	4.0	77	0.0	124	23.5	171	44.3
31	0.0	78	0.0	125	25.0	172	44.2
32	0.0	79	0.0	126	26.8	173	44.1
33	0.0	80	0.0	127	28.2	174	44.0
34	0.0	81	0.0	128	30.0	175	43.9
35	1.5	82	0.0	129	31.4	176	43.8
36	3.8	83	0.0	130	32.5	177	43.7
37	5.6	84	0.0	131	33.2	178	43.6
38	7.5	85	0.0	132	33.4	179	43.5
39	9.2	86	0.0	133	33.7	180	43.4
40	10.8	87	0.0	134	33.9	181	43.3
41	12.4	88	0.0	135	34.2	182	43.1
42	13.8	89	0.0	136	34.4	183	42.9
43	15.2	90	0.0	137	34.7	184	42.7
44	16.3	91	0.0	138	34.9	185	42.5
45	17.3	92	0.0	139	35.2	186	42.3
46	18.0	93	0.0	140	35.4	187	42.2

<i>Time in s</i>	<i>Speed in km/h</i>	<i>Time in s</i>	<i>Speed in km/h</i>	<i>Time in s</i>	<i>Speed in km/h</i>	<i>Time in s</i>	<i>Speed in km/h</i>
188	42.2	237	39.7	286	25.3	335	14.3
189	42.2	238	39.9	287	24.9	336	14.3
190	42.3	239	40.0	288	24.5	337	14.0
191	42.4	240	40.1	289	24.2	338	13.0
192	42.5	241	40.2	290	24.0	339	11.4
193	42.7	242	40.3	291	23.8	340	10.2
194	42.9	243	40.4	292	23.6	341	8.0
195	43.1	244	40.5	293	23.5	342	7.0
196	43.2	245	40.5	294	23.4	343	6.0
197	43.3	246	40.4	295	23.3	344	5.5
198	43.4	247	40.3	296	23.3	345	5.0
199	43.4	248	40.2	297	23.2	346	4.5
200	43.2	249	40.1	298	23.1	347	4.0
201	42.9	250	39.7	299	23.0	348	3.5
202	42.6	251	38.8	300	22.8	349	3.0
203	42.2	252	37.4	301	22.5	350	2.5
204	41.9	253	35.6	302	22.1	351	2.0
205	41.5	254	33.4	303	21.7	352	1.5
206	41.0	255	31.2	304	21.1	353	1.0
207	40.5	256	29.1	305	20.4	354	0.5
208	39.9	257	27.6	306	19.5	355	0.0
209	39.3	258	26.6	307	18.5	356	0.0
210	38.7	259	26.2	308	17.6	357	0.0
211	38.1	260	26.3	309	16.6	358	0.0
212	37.5	261	26.7	310	15.7	359	0.0
213	36.9	262	27.5	311	14.9	360	0.0
214	36.3	263	28.4	312	14.3	361	2.2
215	35.7	264	29.4	313	14.1	362	4.5
216	35.1	265	30.4	314	14.0	363	6.6
217	34.5	266	31.2	315	13.9	364	8.6
218	33.9	267	31.9	316	13.8	365	10.6
219	33.6	268	32.5	317	13.7	366	12.5
220	33.5	269	33.0	318	13.6	367	14.4
221	33.6	270	33.4	319	13.5	368	16.3
222	33.9	271	33.8	320	13.4	369	17.9
223	34.3	272	34.1	321	13.3	370	19.1
224	34.7	273	34.3	322	13.2	371	19.9
225	35.1	274	34.3	323	13.2	372	20.3
226	35.5	275	33.9	324	13.2	373	20.5
227	35.9	276	33.3	325	13.4	374	20.7
228	36.4	277	32.6	326	13.5	375	21.0
229	36.9	278	31.8	327	13.7	376	21.6
230	37.4	279	30.7	328	13.8	377	22.6
231	37.9	280	29.6	329	14.0	378	23.7
232	38.3	281	28.6	330	14.1	379	24.8
233	38.7	282	27.8	331	14.3	380	25.7
234	39.1	283	27.0	332	14.4	381	26.2
235	39.3	284	26.4	333	14.4	382	26.4
236	39.5	285	25.8	334	14.4	383	26.4

<i>Time in s</i>	<i>Speed in km/h</i>	<i>Time in s</i>	<i>Speed in km/h</i>	<i>Time in s</i>	<i>Speed in km/h</i>	<i>Time in s</i>	<i>Speed in km/h</i>
384	26.4	433	0.0	482	3.1	531	48.2
385	26.5	434	0.0	483	4.6	532	48.5
386	26.6	435	0.0	484	6.1	533	48.7
387	26.8	436	0.0	485	7.8	534	48.9
388	26.9	437	0.0	486	9.5	535	49.1
389	27.2	438	0.0	487	11.3	536	49.1
390	27.5	439	0.0	488	13.2	537	49.0
391	28.0	440	0.0	489	15.0	538	48.8
392	28.8	441	0.0	490	16.8	539	48.6
393	29.9	442	0.0	491	18.4	540	48.5
394	31.0	443	0.0	492	20.1	541	48.4
395	31.9	444	0.0	493	21.6	542	48.3
396	32.5	445	0.0	494	23.1	543	48.2
397	32.6	446	0.0	495	24.6	544	48.1
398	32.4	447	0.0	496	26.0	545	47.5
399	32.0	448	0.0	497	27.5	546	46.7
400	31.3	449	0.0	498	29.0	547	45.7
401	30.3	450	0.0	499	30.6	548	44.6
402	28.0	451	0.0	500	32.1	549	42.9
403	27.0	452	0.0	501	33.7	550	40.8
404	24.0	453	0.0	502	35.3	551	38.2
405	22.5	454	0.0	503	36.8	552	35.3
406	19.0	455	0.0	504	38.1	553	31.8
407	17.5	456	0.0	505	39.3	554	28.7
408	14.0	457	0.0	506	40.4	555	25.8
409	12.5	458	0.0	507	41.2	556	22.9
410	9.0	459	0.0	508	41.9	557	20.2
411	7.5	460	0.0	509	42.6	558	17.3
412	4.0	461	0.0	510	43.3	559	15.0
413	2.9	462	0.0	511	44.0	560	12.3
414	0.0	463	0.0	512	44.6	561	10.3
415	0.0	464	0.0	513	45.3	562	7.8
416	0.0	465	0.0	514	45.5	563	6.5
417	0.0	466	0.0	515	45.5	564	4.4
418	0.0	467	0.0	516	45.2	565	3.2
419	0.0	468	0.0	517	44.7	566	1.2
420	0.0	469	0.0	518	44.2	567	0.0
421	0.0	470	0.0	519	43.6	568	0.0
422	0.0	471	0.0	520	43.1	569	0.0
423	0.0	472	0.0	521	42.8	570	0.0
424	0.0	473	0.0	522	42.7	571	0.0
425	0.0	474	0.0	523	42.8	572	0.0
426	0.0	475	0.0	524	43.3	573	0.0
427	0.0	476	0.0	525	43.9	574	0.0
428	0.0	477	0.0	526	44.6	575	0.0
429	0.0	478	0.0	527	45.4	576	0.0
430	0.0	479	0.0	528	46.3	577	0.0
431	0.0	480	0.0	529	47.2	578	0.0
432	0.0	481	1.6	530	47.8	579	0.0

<i>Time in s</i>	<i>Speed in km/h</i>	<i>Time in s</i>	<i>Speed in km/h</i>	<i>Time in s</i>	<i>Speed in km/h</i>	<i>Time in s</i>	<i>Speed in km/h</i>
580	0.0						
581	0.0						
582	0.0						
583	0.0						
584	0.0						
585	0.0						
586	0.0						
587	0.0						
588	0.0						
589	0.0						

Table A1/2a
WLTC, Class 1 cycle, phase Medium₁ (The start of this phase is at second 589)

<i>Time in s</i>	<i>Speed in km/h</i>	<i>Time in s</i>	<i>Speed in km/h</i>	<i>Time in s</i>	<i>Speed in km/h</i>	<i>Time in s</i>	<i>Speed in km/h</i>
590	0.0	637	18.4	684	56.2	731	57.9
591	0.0	638	19.0	685	56.7	732	58.8
592	0.0	639	20.1	686	57.3	733	59.6
593	0.0	640	21.5	687	57.9	734	60.3
594	0.0	641	23.1	688	58.4	735	60.9
595	0.0	642	24.9	689	58.8	736	61.3
596	0.0	643	26.4	690	58.9	737	61.7
597	0.0	644	27.9	691	58.4	738	61.8
598	0.0	645	29.2	692	58.1	739	61.8
599	0.0	646	30.4	693	57.6	740	61.6
600	0.6	647	31.6	694	56.9	741	61.2
601	1.9	648	32.8	695	56.3	742	60.8
602	2.7	649	34.0	696	55.7	743	60.4
603	5.2	650	35.1	697	55.3	744	59.9
604	7.0	651	36.3	698	55.0	745	59.4
605	9.6	652	37.4	699	54.7	746	58.9
606	11.4	653	38.6	700	54.5	747	58.6
607	14.1	654	39.6	701	54.4	748	58.2
608	15.8	655	40.6	702	54.3	749	57.9
609	18.2	656	41.6	703	54.2	750	57.7
610	19.7	657	42.4	704	54.1	751	57.5
611	21.8	658	43.0	705	53.8	752	57.2
612	23.2	659	43.6	706	53.5	753	57.0
613	24.7	660	44.0	707	53.0	754	56.8
614	25.8	661	44.4	708	52.6	755	56.6
615	26.7	662	44.8	709	52.2	756	56.6
616	27.2	663	45.2	710	51.9	757	56.7
617	27.7	664	45.6	711	51.7	758	57.1
618	28.1	665	46.0	712	51.7	759	57.6
619	28.4	666	46.5	713	51.8	760	58.2
620	28.7	667	47.0	714	52.0	761	59.0
621	29.0	668	47.5	715	52.3	762	59.8
622	29.2	669	48.0	716	52.6	763	60.6
623	29.4	670	48.6	717	52.9	764	61.4
624	29.4	671	49.1	718	53.1	765	62.2
625	29.3	672	49.7	719	53.2	766	62.9
626	28.9	673	50.2	720	53.3	767	63.5
627	28.5	674	50.8	721	53.3	768	64.2
628	28.1	675	51.3	722	53.4	769	64.4
629	27.6	676	51.8	723	53.5	770	64.4
630	26.9	677	52.3	724	53.7	771	64.0
631	26.0	678	52.9	725	54.0	772	63.5
632	24.6	679	53.4	726	54.4	773	62.9
633	22.8	680	54.0	727	54.9	774	62.4
634	21.0	681	54.5	728	55.6	775	62.0
635	19.5	682	55.1	729	56.3	776	61.6
636	18.6	683	55.6	730	57.1	777	61.4

<i>Time in s</i>	<i>Speed in km/h</i>	<i>Time in s</i>	<i>Speed in km/h</i>	<i>Time in s</i>	<i>Speed in km/h</i>	<i>Time in s</i>	<i>Speed in km/h</i>
778	61.2	827	49.7	876	53.2	925	44.4
779	61.0	828	50.6	877	53.1	926	44.5
780	60.7	829	51.6	878	53.0	927	44.6
781	60.2	830	52.5	879	53.0	928	44.7
782	59.6	831	53.3	880	53.0	929	44.6
783	58.9	832	54.1	881	53.0	930	44.5
784	58.1	833	54.7	882	53.0	931	44.4
785	57.2	834	55.3	883	53.0	932	44.2
786	56.3	835	55.7	884	52.8	933	44.1
787	55.3	836	56.1	885	52.5	934	43.7
788	54.4	837	56.4	886	51.9	935	43.3
789	53.4	838	56.7	887	51.1	936	42.8
790	52.4	839	57.1	888	50.2	937	42.3
791	51.4	840	57.5	889	49.2	938	41.6
792	50.4	841	58.0	890	48.2	939	40.7
793	49.4	842	58.7	891	47.3	940	39.8
794	48.5	843	59.3	892	46.4	941	38.8
795	47.5	844	60.0	893	45.6	942	37.8
796	46.5	845	60.6	894	45.0	943	36.9
797	45.4	846	61.3	895	44.3	944	36.1
798	44.3	847	61.5	896	43.8	945	35.5
799	43.1	848	61.5	897	43.3	946	35.0
800	42.0	849	61.4	898	42.8	947	34.7
801	40.8	850	61.2	899	42.4	948	34.4
802	39.7	851	60.5	900	42.0	949	34.1
803	38.8	852	60.0	901	41.6	950	33.9
804	38.1	853	59.5	902	41.1	951	33.6
805	37.4	854	58.9	903	40.3	952	33.3
806	37.1	855	58.4	904	39.5	953	33.0
807	36.9	856	57.9	905	38.6	954	32.7
808	37.0	857	57.5	906	37.7	955	32.3
809	37.5	858	57.1	907	36.7	956	31.9
810	37.8	859	56.7	908	36.2	957	31.5
811	38.2	860	56.4	909	36.0	958	31.0
812	38.6	861	56.1	910	36.2	959	30.6
813	39.1	862	55.8	911	37.0	960	30.2
814	39.6	863	55.5	912	38.0	961	29.7
815	40.1	864	55.3	913	39.0	962	29.1
816	40.7	865	55.0	914	39.7	963	28.4
817	41.3	866	54.7	915	40.2	964	27.6
818	41.9	867	54.4	916	40.7	965	26.8
819	42.7	868	54.2	917	41.2	966	26.0
820	43.4	869	54.0	918	41.7	967	25.1
821	44.2	870	53.9	919	42.2	968	24.2
822	45.0	871	53.7	920	42.7	969	23.3
823	45.9	872	53.6	921	43.2	970	22.4
824	46.8	873	53.5	922	43.6	971	21.5
825	47.7	874	53.4	923	44.0	972	20.6
826	48.7	875	53.3	924	44.2	973	19.7

<i>Time in s</i>	<i>Speed in km/h</i>	<i>Time in s</i>	<i>Speed in km/h</i>	<i>Time in s</i>	<i>Speed in km/h</i>	<i>Time in s</i>	<i>Speed in km/h</i>
974	18.8						
975	17.7						
976	16.4						
977	14.9						
978	13.2						
979	11.3						
980	9.4						
981	7.5						
982	5.6						
983	3.7						
984	1.9						
985	1.0						
986	0.0						
987	0.0						
988	0.0						
989	0.0						
990	0.0						
991	0.0						
992	0.0						
993	0.0						
994	0.0						
995	0.0						
996	0.0						
997	0.0						
998	0.0						
999	0.0						
1000	0.0						
1001	0.0						
1002	0.0						
1003	0.0						
1004	0.0						
1005	0.0						
1006	0.0						
1007	0.0						
1008	0.0						
1009	0.0						
1010	0.0						
1011	0.0						
1012	0.0						
1013	0.0						
1014	0.0						
1015	0.0						
1016	0.0						
1017	0.0						
1018	0.0						
1019	0.0						
1020	0.0						
1021	0.0						
1022	0.0						

Table A1/2b
WLTC, Class 1 cycle, phase Low₁₂ (Second 1022 is the end of phase Medium1 and the start of phase Low₁₂)

<i>Time in s</i>	<i>Speed in km/h</i>	<i>Time in s</i>	<i>Speed in km/h</i>	<i>Time in s</i>	<i>Speed in km/h</i>	<i>Time in s</i>	<i>Speed in km/h</i>
1023	0.0	1070	19.5	1117	0.0	1164	35.9
1024	0.0	1071	20.2	1118	0.0	1165	36.6
1025	0.0	1072	20.9	1119	0.0	1166	37.5
1026	0.0	1073	21.7	1120	0.0	1167	38.4
1027	0.0	1074	22.4	1121	0.0	1168	39.3
1028	0.0	1075	23.1	1122	0.0	1169	40.0
1029	0.0	1076	23.7	1123	0.0	1170	40.6
1030	0.0	1077	24.4	1124	0.0	1171	41.1
1031	0.0	1078	25.1	1125	0.0	1172	41.4
1032	0.0	1079	25.4	1126	0.0	1173	41.6
1033	0.0	1080	25.2	1127	0.0	1174	41.8
1034	0.2	1081	23.4	1128	0.0	1175	41.8
1035	3.1	1082	21.8	1129	0.0	1176	41.9
1036	5.7	1083	19.7	1130	0.7	1177	41.9
1037	8.0	1084	17.3	1131	1.1	1178	42.0
1038	10.1	1085	14.7	1132	1.9	1179	42.0
1039	12.0	1086	12.0	1133	2.5	1180	42.2
1040	13.8	1087	9.4	1134	3.5	1181	42.3
1041	15.4	1088	5.6	1135	4.7	1182	42.6
1042	16.7	1089	3.1	1136	6.1	1183	43.0
1043	17.7	1090	0.0	1137	7.5	1184	43.3
1044	18.3	1091	0.0	1138	9.4	1185	43.7
1045	18.8	1092	0.0	1139	11.0	1186	44.0
1046	18.9	1093	0.0	1140	12.9	1187	44.3
1047	18.4	1094	0.0	1141	14.5	1188	44.5
1048	16.9	1095	0.0	1142	16.4	1189	44.6
1049	14.3	1096	0.0	1143	18.0	1190	44.6
1050	10.8	1097	0.0	1144	20.0	1191	44.5
1051	7.1	1098	0.0	1145	21.5	1192	44.4
1052	4.0	1099	0.0	1146	23.5	1193	44.3
1053	0.0	1100	0.0	1147	25.0	1194	44.2
1054	0.0	1101	0.0	1148	26.8	1195	44.1
1055	0.0	1102	0.0	1149	28.2	1196	44.0
1056	0.0	1103	0.0	1150	30.0	1197	43.9
1057	1.5	1104	0.0	1151	31.4	1198	43.8
1058	3.8	1105	0.0	1152	32.5	1199	43.7
1059	5.6	1106	0.0	1153	33.2	1200	43.6
1060	7.5	1107	0.0	1154	33.4	1201	43.5
1061	9.2	1108	0.0	1155	33.7	1202	43.4
1062	10.8	1109	0.0	1156	33.9	1203	43.3
1063	12.4	1110	0.0	1157	34.2	1204	43.1
1064	13.8	1111	0.0	1158	34.4	1205	42.9
1065	15.2	1112	0.0	1159	34.7	1206	42.7
1066	16.3	1113	0.0	1160	34.9	1207	42.5
1067	17.3	1114	0.0	1161	35.2	1208	42.3
1068	18.0	1115	0.0	1162	35.4	1209	42.2
1069	18.8	1116	0.0	1163	35.7	1210	42.2

<i>Time in s</i>	<i>Speed in km/h</i>	<i>Time in s</i>	<i>Speed in km/h</i>	<i>Time in s</i>	<i>Speed in km/h</i>	<i>Time in s</i>	<i>Speed in km/h</i>
1211	42.2	1260	39.9	1309	24.9	1358	14.3
1212	42.3	1261	40.0	1310	24.5	1359	14.0
1213	42.4	1262	40.1	1311	24.2	1360	13.0
1214	42.5	1263	40.2	1312	24.0	1361	11.4
1215	42.7	1264	40.3	1313	23.8	1362	10.2
1216	42.9	1265	40.4	1314	23.6	1363	8.0
1217	43.1	1266	40.5	1315	23.5	1364	7.0
1218	43.2	1267	40.5	1316	23.4	1365	6.0
1219	43.3	1268	40.4	1317	23.3	1366	5.5
1220	43.4	1269	40.3	1318	23.3	1367	5.0
1221	43.4	1270	40.2	1319	23.2	1368	4.5
1222	43.2	1271	40.1	1320	23.1	1369	4.0
1223	42.9	1272	39.7	1321	23.0	1370	3.5
1224	42.6	1273	38.8	1322	22.8	1371	3.0
1225	42.2	1274	37.4	1323	22.5	1372	2.5
1226	41.9	1275	35.6	1324	22.1	1373	2.0
1227	41.5	1276	33.4	1325	21.7	1374	1.5
1228	41.0	1277	31.2	1326	21.1	1375	1.0
1229	40.5	1278	29.1	1327	20.4	1376	0.5
1230	39.9	1279	27.6	1328	19.5	1377	0.0
1231	39.3	1280	26.6	1329	18.5	1378	0.0
1232	38.7	1281	26.2	1330	17.6	1379	0.0
1233	38.1	1282	26.3	1331	16.6	1380	0.0
1234	37.5	1283	26.7	1332	15.7	1381	0.0
1235	36.9	1284	27.5	1333	14.9	1382	0.0
1236	36.3	1285	28.4	1334	14.3	1383	2.2
1237	35.7	1286	29.4	1335	14.1	1384	4.5
1238	35.1	1287	30.4	1336	14.0	1385	6.6
1239	34.5	1288	31.2	1337	13.9	1386	8.6
1240	33.9	1289	31.9	1338	13.8	1387	10.6
1241	33.6	1290	32.5	1339	13.7	1388	12.5
1242	33.5	1291	33.0	1340	13.6	1389	14.4
1243	33.6	1292	33.4	1341	13.5	1390	16.3
1244	33.9	1293	33.8	1342	13.4	1391	17.9
1245	34.3	1294	34.1	1343	13.3	1392	19.1
1246	34.7	1295	34.3	1344	13.2	1393	19.9
1247	35.1	1296	34.3	1345	13.2	1394	20.3
1248	35.5	1297	33.9	1346	13.2	1395	20.5
1249	35.9	1298	33.3	1347	13.4	1396	20.7
1250	36.4	1299	32.6	1348	13.5	1397	21.0
1251	36.9	1300	31.8	1349	13.7	1398	21.6
1252	37.4	1301	30.7	1350	13.8	1399	22.6
1253	37.9	1302	29.6	1351	14.0	1400	23.7
1254	38.3	1303	28.6	1352	14.1	1401	24.8
1255	38.7	1304	27.8	1353	14.3	1402	25.7
1256	39.1	1305	27.0	1354	14.4	1403	26.2
1257	39.3	1306	26.4	1355	14.4	1404	26.4
1258	39.5	1307	25.8	1356	14.4	1405	26.4
1259	39.7	1308	25.3	1357	14.3	1406	26.4

<i>Time in s</i>	<i>Speed in km/h</i>	<i>Time in s</i>	<i>Speed in km/h</i>	<i>Time in s</i>	<i>Speed in km/h</i>	<i>Time in s</i>	<i>Speed in km/h</i>
1407	26.5	1456	0.0	1505	4.6	1554	48.5
1408	26.6	1457	0.0	1506	6.1	1555	48.7
1409	26.8	1458	0.0	1507	7.8	1556	48.9
1410	26.9	1459	0.0	1508	9.5	1557	49.1
1411	27.2	1460	0.0	1509	11.3	1558	49.1
1412	27.5	1461	0.0	1510	13.2	1559	49.0
1413	28.0	1462	0.0	1511	15.0	1560	48.8
1414	28.8	1463	0.0	1512	16.8	1561	48.6
1415	29.9	1464	0.0	1513	18.4	1562	48.5
1416	31.0	1465	0.0	1514	20.1	1563	48.4
1417	31.9	1466	0.0	1515	21.6	1564	48.3
1418	32.5	1467	0.0	1516	23.1	1565	48.2
1419	32.6	1468	0.0	1517	24.6	1566	48.1
1420	32.4	1469	0.0	1518	26.0	1567	47.5
1421	32.0	1470	0.0	1519	27.5	1568	46.7
1422	31.3	1471	0.0	1520	29.0	1569	45.7
1423	30.3	1472	0.0	1521	30.6	1570	44.6
1424	28.0	1473	0.0	1522	32.1	1571	42.9
1425	27.0	1474	0.0	1523	33.7	1572	40.8
1426	24.0	1475	0.0	1524	35.3	1573	38.2
1427	22.5	1476	0.0	1525	36.8	1574	35.3
1428	19.0	1477	0.0	1526	38.1	1575	31.8
1429	17.5	1478	0.0	1527	39.3	1576	28.7
1430	14.0	1479	0.0	1528	40.4	1577	25.8
1431	12.5	1480	0.0	1529	41.2	1578	22.9
1432	9.0	1481	0.0	1530	41.9	1579	20.2
1433	7.5	1482	0.0	1531	42.6	1580	17.3
1434	4.0	1483	0.0	1532	43.3	1581	15.0
1435	2.9	1484	0.0	1533	44.0	1582	12.3
1436	0.0	1485	0.0	1534	44.6	1583	10.3
1437	0.0	1486	0.0	1535	45.3	1584	7.8
1438	0.0	1487	0.0	1536	45.5	1585	6.5
1439	0.0	1488	0.0	1537	45.5	1586	4.4
1440	0.0	1489	0.0	1538	45.2	1587	3.2
1441	0.0	1490	0.0	1539	44.7	1588	1.2
1442	0.0	1491	0.0	1540	44.2	1589	0.0
1443	0.0	1492	0.0	1541	43.6	1590	0.0
1444	0.0	1493	0.0	1542	43.1	1591	0.0
1445	0.0	1494	0.0	1543	42.8	1592	0.0
1446	0.0	1495	0.0	1544	42.7	1593	0.0
1447	0.0	1496	0.0	1545	42.8	1594	0.0
1448	0.0	1497	0.0	1546	43.3	1595	0.0
1449	0.0	1498	0.0	1547	43.9	1596	0.0
1450	0.0	1499	0.0	1548	44.6	1597	0.0
1451	0.0	1500	0.0	1549	45.4	1598	0.0
1452	0.0	1501	0.0	1550	46.3	1599	0.0
1453	0.0	1502	0.0	1551	47.2	1600	0.0
1454	0.0	1503	1.6	1552	47.8	1601	0.0
1455	0.0	1504	3.1	1553	48.2	1602	0.0

<i>Time in s</i>	<i>Speed in km/h</i>	<i>Time in s</i>	<i>Speed in km/h</i>	<i>Time in s</i>	<i>Speed in km/h</i>	<i>Time in s</i>	<i>Speed in km/h</i>
1603	0.0						
1604	0.0						
1605	0.0						
1606	0.0						
1607	0.0						
1608	0.0						
1609	0.0						
1610	0.0						
1611	0.0						

5. WLTC Class 2 cycle

Figure A1/3

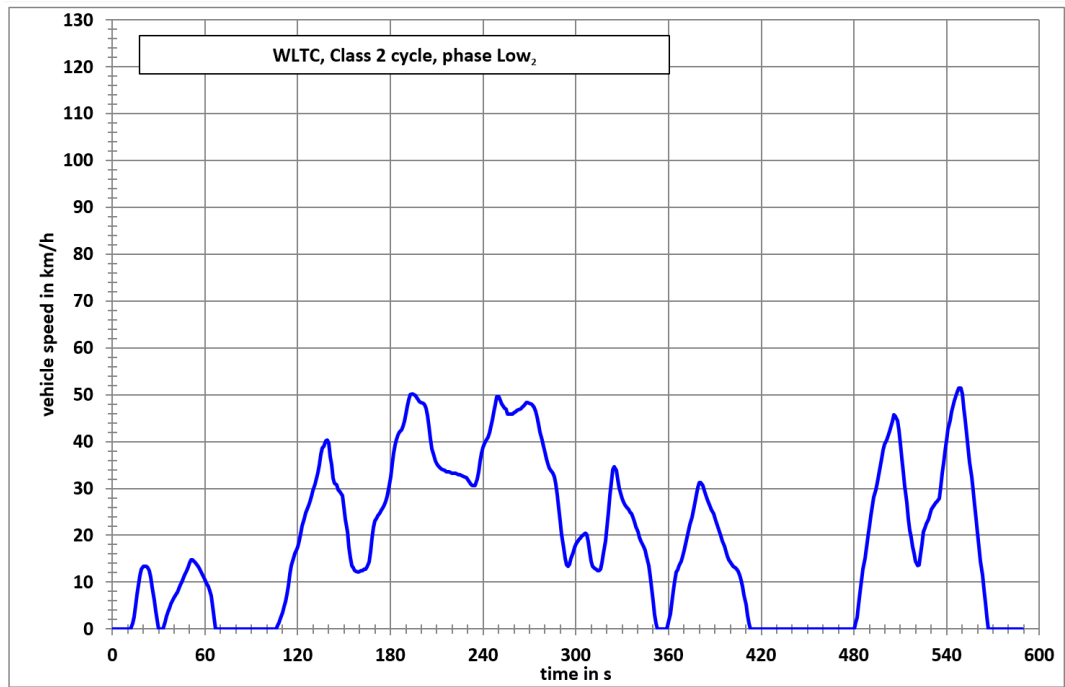
WLTC, Class 2 cycle, phase Low₂

Figure A1/4

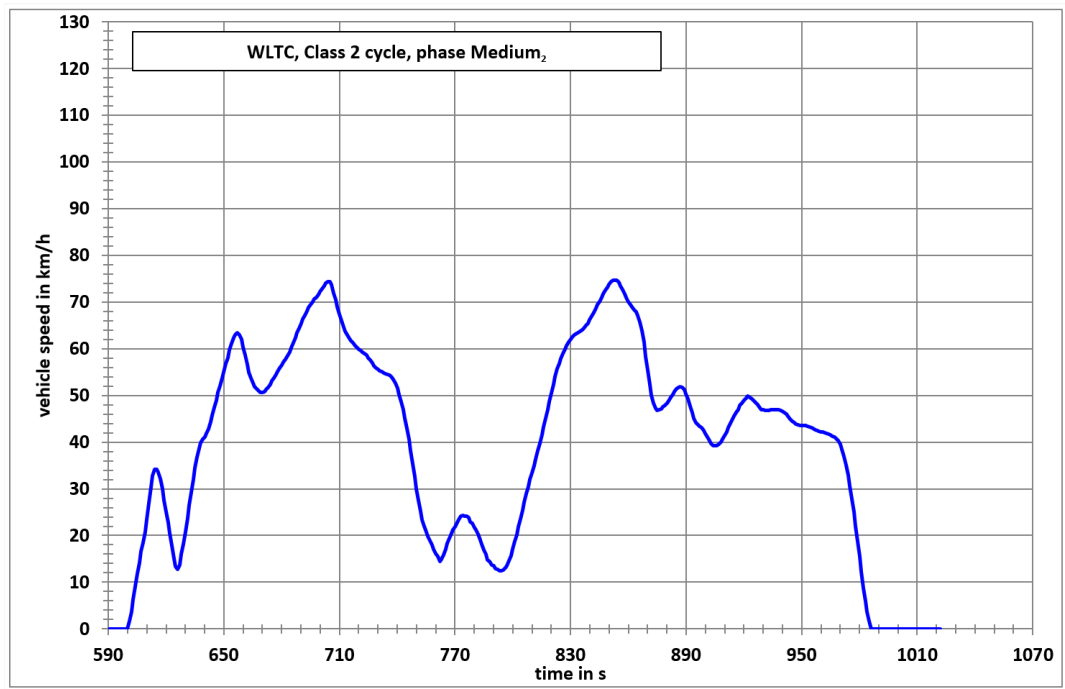
WLTC, Class 2 cycle, phase Medium₂

Figure A1/5
WLTC, Class 2 cycle, phase High₂

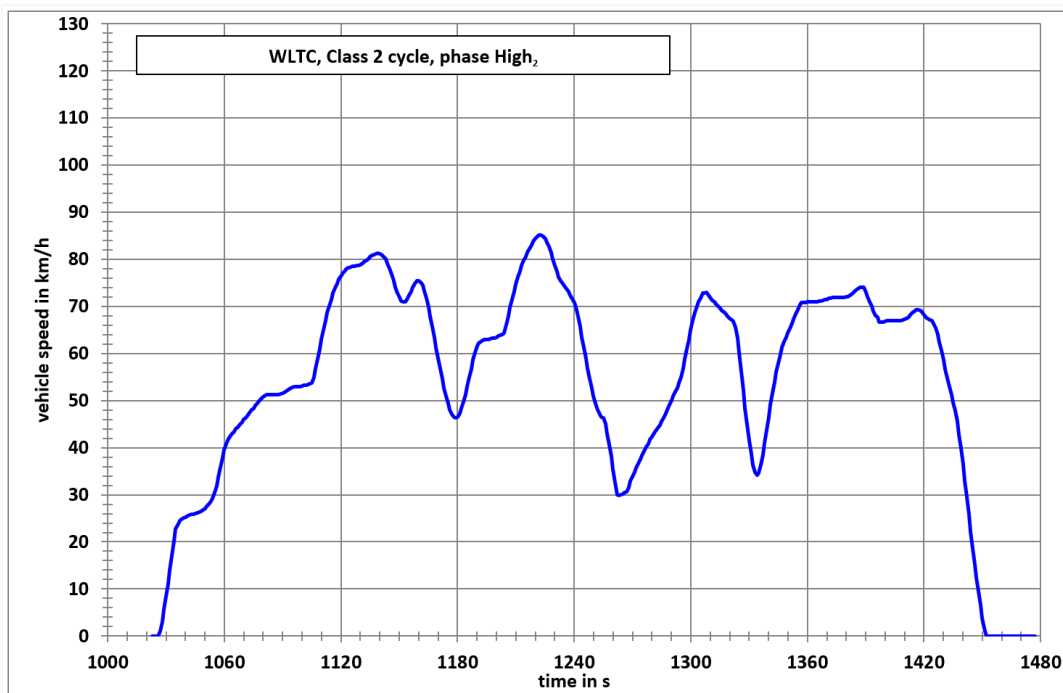


Figure A1/6
WLTC, Class 2 cycle, phase Extra High₂

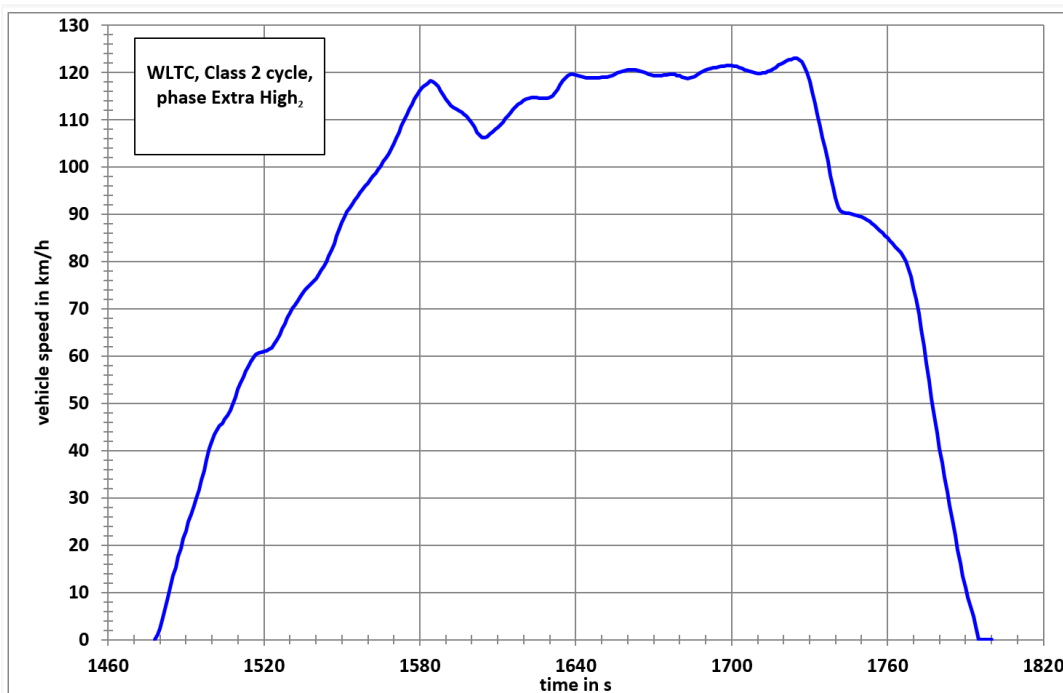


Table A1/3

WLTC, Class 2 cycle, phase Low₂ (Second 589 is the end of phase Low₁ and the start of phase Medium₁)

<i>Time in s</i>	<i>Speed in km/h</i>	<i>Time in s</i>	<i>Speed in km/h</i>	<i>Time in s</i>	<i>Speed in km/h</i>	<i>Time in s</i>	<i>Speed in km/h</i>
0	0.0	47	11.6	94	0.0	141	36.8
1	0.0	48	12.4	95	0.0	142	35.1
2	0.0	49	13.2	96	0.0	143	32.2
3	0.0	50	14.2	97	0.0	144	31.1
4	0.0	51	14.8	98	0.0	145	30.8
5	0.0	52	14.7	99	0.0	146	29.7
6	0.0	53	14.4	100	0.0	147	29.4
7	0.0	54	14.1	101	0.0	148	29.0
8	0.0	55	13.6	102	0.0	149	28.5
9	0.0	56	13.0	103	0.0	150	26.0
10	0.0	57	12.4	104	0.0	151	23.4
11	0.0	58	11.8	105	0.0	152	20.7
12	0.0	59	11.2	106	0.0	153	17.4
13	1.2	60	10.6	107	0.8	154	15.2
14	2.6	61	9.9	108	1.4	155	13.5
15	4.9	62	9.0	109	2.3	156	13.0
16	7.3	63	8.2	110	3.5	157	12.4
17	9.4	64	7.0	111	4.7	158	12.3
18	11.4	65	4.8	112	5.9	159	12.2
19	12.7	66	2.3	113	7.4	160	12.3
20	13.3	67	0.0	114	9.2	161	12.4
21	13.4	68	0.0	115	11.7	162	12.5
22	13.3	69	0.0	116	13.5	163	12.7
23	13.1	70	0.0	117	15.0	164	12.8
24	12.5	71	0.0	118	16.2	165	13.2
25	11.1	72	0.0	119	16.8	166	14.3
26	8.9	73	0.0	120	17.5	167	16.5
27	6.2	74	0.0	121	18.8	168	19.4
28	3.8	75	0.0	122	20.3	169	21.7
29	1.8	76	0.0	123	22.0	170	23.1
30	0.0	77	0.0	124	23.6	171	23.5
31	0.0	78	0.0	125	24.8	172	24.2
32	0.0	79	0.0	126	25.6	173	24.8
33	0.0	80	0.0	127	26.3	174	25.4
34	1.5	81	0.0	128	27.2	175	25.8
35	2.8	82	0.0	129	28.3	176	26.5
36	3.6	83	0.0	130	29.6	177	27.2
37	4.5	84	0.0	131	30.9	178	28.3
38	5.3	85	0.0	132	32.2	179	29.9
39	6.0	86	0.0	133	33.4	180	32.4
40	6.6	87	0.0	134	35.1	181	35.1
41	7.3	88	0.0	135	37.2	182	37.5
42	7.9	89	0.0	136	38.7	183	39.2
43	8.6	90	0.0	137	39.0	184	40.5
44	9.3	91	0.0	138	40.1	185	41.4
45	10	92	0.0	139	40.4	186	42.0
46	10.8	93	0.0	140	39.7	187	42.5

<i>Time in s</i>	<i>Speed in km/h</i>	<i>Time in s</i>	<i>Speed in km/h</i>	<i>Time in s</i>	<i>Speed in km/h</i>	<i>Time in s</i>	<i>Speed in km/h</i>
188	43.2	237	33.5	286	32.5	335	25.0
189	44.4	238	35.8	287	30.9	336	24.6
190	45.9	239	37.6	288	28.6	337	23.9
191	47.6	240	38.8	289	25.9	338	23.0
192	49.0	241	39.6	290	23.1	339	21.8
193	50.0	242	40.1	291	20.1	340	20.7
194	50.2	243	40.9	292	17.3	341	19.6
195	50.1	244	41.8	293	15.1	342	18.7
196	49.8	245	43.3	294	13.7	343	18.1
197	49.4	246	44.7	295	13.4	344	17.5
198	48.9	247	46.4	296	13.9	345	16.7
199	48.5	248	47.9	297	15.0	346	15.4
200	48.3	249	49.6	298	16.3	347	13.6
201	48.2	250	49.6	299	17.4	348	11.2
202	47.9	251	48.8	300	18.2	349	8.6
203	47.1	252	48.0	301	18.6	350	6.0
204	45.5	253	47.5	302	19.0	351	3.1
205	43.2	254	47.1	303	19.4	352	1.2
206	40.6	255	46.9	304	19.8	353	0.0
207	38.5	256	45.8	305	20.1	354	0.0
208	36.9	257	45.8	306	20.5	355	0.0
209	35.9	258	45.8	307	20.2	356	0.0
210	35.3	259	45.9	308	18.6	357	0.0
211	34.8	260	46.2	309	16.5	358	0.0
212	34.5	261	46.4	310	14.4	359	0.0
213	34.2	262	46.6	311	13.4	360	1.4
214	34.0	263	46.8	312	12.9	361	3.2
215	33.8	264	47.0	313	12.7	362	5.6
216	33.6	265	47.3	314	12.4	363	8.1
217	33.5	266	47.5	315	12.4	364	10.3
218	33.5	267	47.9	316	12.8	365	12.1
219	33.4	268	48.3	317	14.1	366	12.6
220	33.3	269	48.3	318	16.2	367	13.6
221	33.3	270	48.2	319	18.8	368	14.5
222	33.2	271	48.0	320	21.9	369	15.6
223	33.1	272	47.7	321	25.0	370	16.8
224	33.0	273	47.2	322	28.4	371	18.2
225	32.9	274	46.5	323	31.3	372	19.6
226	32.8	275	45.2	324	34.0	373	20.9
227	32.7	276	43.7	325	34.6	374	22.3
228	32.5	277	42.0	326	33.9	375	23.8
229	32.3	278	40.4	327	31.9	376	25.4
230	31.8	279	39.0	328	30.0	377	27.0
231	31.4	280	37.7	329	29.0	378	28.6
232	30.9	281	36.4	330	27.9	379	30.2
233	30.6	282	35.2	331	27.1	380	31.2
234	30.6	283	34.3	332	26.4	381	31.2
235	30.7	284	33.8	333	25.9	382	30.7
236	32.0	285	33.3	334	25.5	383	29.5

<i>Time in s</i>	<i>Speed in km/h</i>	<i>Time in s</i>	<i>Speed in km/h</i>	<i>Time in s</i>	<i>Speed in km/h</i>	<i>Time in s</i>	<i>Speed in km/h</i>
384	28.6	433	0.0	482	2.5	531	26.0
385	27.7	434	0.0	483	5.2	532	26.5
386	26.9	435	0.0	484	7.9	533	26.9
387	26.1	436	0.0	485	10.3	534	27.3
388	25.4	437	0.0	486	12.7	535	27.9
389	24.6	438	0.0	487	15.0	536	30.3
390	23.6	439	0.0	488	17.4	537	33.2
391	22.6	440	0.0	489	19.7	538	35.4
392	21.7	441	0.0	490	21.9	539	38.0
393	20.7	442	0.0	491	24.1	540	40.1
394	19.8	443	0.0	492	26.2	541	42.7
395	18.8	444	0.0	493	28.1	542	44.5
396	17.7	445	0.0	494	29.7	543	46.3
397	16.6	446	0.0	495	31.3	544	47.6
398	15.6	447	0.0	496	33.0	545	48.8
399	14.8	448	0.0	497	34.7	546	49.7
400	14.3	449	0.0	498	36.3	547	50.6
401	13.8	450	0.0	499	38.1	548	51.4
402	13.4	451	0.0	500	39.4	549	51.4
403	13.1	452	0.0	501	40.4	550	50.2
404	12.8	453	0.0	502	41.2	551	47.1
405	12.3	454	0.0	503	42.1	552	44.5
406	11.6	455	0.0	504	43.2	553	41.5
407	10.5	456	0.0	505	44.3	554	38.5
408	9.0	457	0.0	506	45.7	555	35.5
409	7.2	458	0.0	507	45.4	556	32.5
410	5.2	459	0.0	508	44.5	557	29.5
411	2.9	460	0.0	509	42.5	558	26.5
412	1.2	461	0.0	510	39.5	559	23.5
413	0.0	462	0.0	511	36.5	560	20.4
414	0.0	463	0.0	512	33.5	561	17.5
415	0.0	464	0.0	513	30.4	562	14.5
416	0.0	465	0.0	514	27.0	563	11.5
417	0.0	466	0.0	515	23.6	564	8.5
418	0.0	467	0.0	516	21.0	565	5.6
419	0.0	468	0.0	517	19.5	566	2.6
420	0.0	469	0.0	518	17.6	567	0.0
421	0.0	470	0.0	519	16.1	568	0.0
422	0.0	471	0.0	520	14.5	569	0.0
423	0.0	472	0.0	521	13.5	570	0.0
424	0.0	473	0.0	522	13.7	571	0.0
425	0.0	474	0.0	523	16.0	572	0.0
426	0.0	475	0.0	524	18.1	573	0.0
427	0.0	476	0.0	525	20.8	574	0.0
428	0.0	477	0.0	526	21.5	575	0.0
429	0.0	478	0.0	527	22.5	576	0.0
430	0.0	479	0.0	528	23.4	577	0.0
431	0.0	480	0.0	529	24.5	578	0.0
432	0.0	481	1.4	530	25.6	579	0.0

<i>Time in s</i>	<i>Speed in km/h</i>	<i>Time in s</i>	<i>Speed in km/h</i>	<i>Time in s</i>	<i>Speed in km/h</i>	<i>Time in s</i>	<i>Speed in km/h</i>
580	0.0						
581	0.0						
582	0.0						
583	0.0						
584	0.0						
585	0.0						
586	0.0						
587	0.0						
588	0.0						
589	0.0						

Table A1/4

WLTC, Class 2 cycle, phase Medium₂ (The start of this phase is at second 589)

<i>Time in s</i>	<i>Speed in km/h</i>	<i>Time in s</i>	<i>Speed in km/h</i>	<i>Time in s</i>	<i>Speed in km/h</i>	<i>Time in s</i>	<i>Speed in km/h</i>
590	0.0	637	38.6	684	59.3	731	55.3
591	0.0	638	39.8	685	60.2	732	55.1
592	0.0	639	40.6	686	61.3	733	54.8
593	0.0	640	41.1	687	62.4	734	54.6
594	0.0	641	41.9	688	63.4	735	54.5
595	0.0	642	42.8	689	64.4	736	54.3
596	0.0	643	44.3	690	65.4	737	53.9
597	0.0	644	45.7	691	66.3	738	53.4
598	0.0	645	47.4	692	67.2	739	52.6
599	0.0	646	48.9	693	68.0	740	51.5
600	0.0	647	50.6	694	68.8	741	50.2
601	1.6	648	52.0	695	69.5	742	48.7
602	3.6	649	53.7	696	70.1	743	47.0
603	6.3	650	55.0	697	70.6	744	45.1
604	9.0	651	56.8	698	71.0	745	43.0
605	11.8	652	58.0	699	71.6	746	40.6
606	14.2	653	59.8	700	72.2	747	38.1
607	16.6	654	61.1	701	72.8	748	35.4
608	18.5	655	62.4	702	73.5	749	32.7
609	20.8	656	63.0	703	74.1	750	30.0
610	23.4	657	63.5	704	74.3	751	27.5
611	26.9	658	63.0	705	74.3	752	25.3
612	30.3	659	62.0	706	73.7	753	23.4
613	32.8	660	60.4	707	71.9	754	22.0
614	34.1	661	58.6	708	70.5	755	20.8
615	34.2	662	56.7	709	68.9	756	19.8
616	33.6	663	55.0	710	67.4	757	18.9
617	32.1	664	53.7	711	66.0	758	18.0
618	30.0	665	52.7	712	64.7	759	17.0
619	27.5	666	51.9	713	63.7	760	16.1
620	25.1	667	51.4	714	62.9	761	15.5
621	22.8	668	51.0	715	62.2	762	14.4
622	20.5	669	50.7	716	61.7	763	14.9
623	17.9	670	50.6	717	61.2	764	15.9
624	15.1	671	50.8	718	60.7	765	17.1
625	13.4	672	51.2	719	60.3	766	18.3
626	12.8	673	51.7	720	59.9	767	19.4
627	13.7	674	52.3	721	59.6	768	20.4
628	16.0	675	53.1	722	59.3	769	21.2
629	18.1	676	53.8	723	59.0	770	21.9
630	20.8	677	54.5	724	58.6	771	22.7
631	23.7	678	55.1	725	58.0	772	23.4
632	26.5	679	55.9	726	57.5	773	24.2
633	29.3	680	56.5	727	56.9	774	24.3
634	32.0	681	57.1	728	56.3	775	24.2
635	34.5	682	57.8	729	55.9	776	24.1
636	36.8	683	58.5	730	55.6	777	23.8

<i>Time in s</i>	<i>Speed in km/h</i>	<i>Time in s</i>	<i>Speed in km/h</i>	<i>Time in s</i>	<i>Speed in km/h</i>	<i>Time in s</i>	<i>Speed in km/h</i>
778	23.0	827	59.9	876	46.9	925	49.0
779	22.6	828	60.7	877	47.1	926	48.5
780	21.7	829	61.4	878	47.5	927	48.0
781	21.3	830	62.0	879	47.8	928	47.5
782	20.3	831	62.5	880	48.3	929	47.0
783	19.1	832	62.9	881	48.8	930	46.9
784	18.1	833	63.2	882	49.5	931	46.8
785	16.9	834	63.4	883	50.2	932	46.8
786	16.0	835	63.7	884	50.8	933	46.8
787	14.8	836	64.0	885	51.4	934	46.9
788	14.5	837	64.4	886	51.8	935	46.9
789	13.7	838	64.9	887	51.9	936	46.9
790	13.5	839	65.5	888	51.7	937	46.9
791	12.9	840	66.2	889	51.2	938	46.9
792	12.7	841	67.0	890	50.4	939	46.8
793	12.5	842	67.8	891	49.2	940	46.6
794	12.5	843	68.6	892	47.7	941	46.4
795	12.6	844	69.4	893	46.3	942	46.0
796	13.0	845	70.1	894	45.1	943	45.5
797	13.6	846	70.9	895	44.2	944	45.0
798	14.6	847	71.7	896	43.7	945	44.5
799	15.7	848	72.5	897	43.4	946	44.2
800	17.1	849	73.2	898	43.1	947	43.9
801	18.7	850	73.8	899	42.5	948	43.7
802	20.2	851	74.4	900	41.8	949	43.6
803	21.9	852	74.7	901	41.1	950	43.6
804	23.6	853	74.7	902	40.3	951	43.5
805	25.4	854	74.6	903	39.7	952	43.5
806	27.1	855	74.2	904	39.3	953	43.4
807	28.9	856	73.5	905	39.2	954	43.3
808	30.4	857	72.6	906	39.3	955	43.1
809	32.0	858	71.8	907	39.6	956	42.9
810	33.4	859	71.0	908	40.0	957	42.7
811	35.0	860	70.1	909	40.7	958	42.5
812	36.4	861	69.4	910	41.4	959	42.4
813	38.1	862	68.9	911	42.2	960	42.2
814	39.7	863	68.4	912	43.1	961	42.1
815	41.6	864	67.9	913	44.1	962	42.0
816	43.3	865	67.1	914	44.9	963	41.8
817	45.1	866	65.8	915	45.6	964	41.7
818	46.9	867	63.9	916	46.4	965	41.5
819	48.7	868	61.4	917	47.0	966	41.3
820	50.5	869	58.4	918	47.8	967	41.1
821	52.4	870	55.4	919	48.3	968	40.8
822	54.1	871	52.4	920	48.9	969	40.3
823	55.7	872	50.0	921	49.4	970	39.6
824	56.8	873	48.3	922	49.8	971	38.5
825	57.9	874	47.3	923	49.6	972	37.0
826	59.0	875	46.8	924	49.3	973	35.1

<i>Time in s</i>	<i>Speed in km/h</i>	<i>Time in s</i>	<i>Speed in km/h</i>	<i>Time in s</i>	<i>Speed in km/h</i>	<i>Time in s</i>	<i>Speed in km/h</i>
974	33.0						
975	30.6						
976	27.9						
977	25.1						
978	22.0						
979	18.8						
980	15.5						
981	12.3						
982	8.8						
983	6.0						
984	3.6						
985	1.6						
986	0.0						
987	0.0						
988	0.0						
989	0.0						
990	0.0						
991	0.0						
992	0.0						
993	0.0						
994	0.0						
995	0.0						
996	0.0						
997	0.0						
998	0.0						
999	0.0						
1000	0.0						
1001	0.0						
1002	0.0						
1003	0.0						
1004	0.0						
1005	0.0						
1006	0.0						
1007	0.0						
1008	0.0						
1009	0.0						
1010	0.0						
1011	0.0						
1012	0.0						
1013	0.0						
1014	0.0						
1015	0.0						
1016	0.0						
1017	0.0						
1018	0.0						
1019	0.0						
1020	0.0						
1021	0.0						
1022	0.0						

Table A1/5

WLTC, Class 2 cycle, phase High₂ (Second 1022 is the end of phase Medium₂ and the start of phase High₂)

<i>Time in s</i>	<i>Speed in km/h</i>	<i>Time in s</i>	<i>Speed in km/h</i>	<i>Time in s</i>	<i>Speed in km/h</i>	<i>Time in s</i>	<i>Speed in km/h</i>
1023	0.0	1070	46.0	1117	73.9	1164	71.7
1024	0.0	1071	46.4	1118	74.9	1165	69.9
1025	0.0	1072	47.0	1119	75.7	1166	67.9
1026	0.0	1073	47.4	1120	76.4	1167	65.7
1027	1.1	1074	48.0	1121	77.1	1168	63.5
1028	3.0	1075	48.4	1122	77.6	1169	61.2
1029	5.7	1076	49.0	1123	78.0	1170	59.0
1030	8.4	1077	49.4	1124	78.2	1171	56.8
1031	11.1	1078	50.0	1125	78.4	1172	54.7
1032	14.0	1079	50.4	1126	78.5	1173	52.7
1033	17.0	1080	50.8	1127	78.5	1174	50.9
1034	20.1	1081	51.1	1128	78.6	1175	49.4
1035	22.7	1082	51.3	1129	78.7	1176	48.1
1036	23.6	1083	51.3	1130	78.9	1177	47.1
1037	24.5	1084	51.3	1131	79.1	1178	46.5
1038	24.8	1085	51.3	1132	79.4	1179	46.3
1039	25.1	1086	51.3	1133	79.8	1180	46.5
1040	25.3	1087	51.3	1134	80.1	1181	47.2
1041	25.5	1088	51.3	1135	80.5	1182	48.3
1042	25.7	1089	51.4	1136	80.8	1183	49.7
1043	25.8	1090	51.6	1137	81.0	1184	51.3
1044	25.9	1091	51.8	1138	81.2	1185	53.0
1045	26.0	1092	52.1	1139	81.3	1186	54.9
1046	26.1	1093	52.3	1140	81.2	1187	56.7
1047	26.3	1094	52.6	1141	81.0	1188	58.6
1048	26.5	1095	52.8	1142	80.6	1189	60.2
1049	26.8	1096	52.9	1143	80.0	1190	61.6
1050	27.1	1097	53.0	1144	79.1	1191	62.2
1051	27.5	1098	53.0	1145	78.0	1192	62.5
1052	28.0	1099	53.0	1146	76.8	1193	62.8
1053	28.6	1100	53.1	1147	75.5	1194	62.9
1054	29.3	1101	53.2	1148	74.1	1195	63.0
1055	30.4	1102	53.3	1149	72.9	1196	63.0
1056	31.8	1103	53.4	1150	71.9	1197	63.1
1057	33.7	1104	53.5	1151	71.2	1198	63.2
1058	35.8	1105	53.7	1152	70.9	1199	63.3
1059	37.8	1106	55.0	1153	71.0	1200	63.5
1060	39.5	1107	56.8	1154	71.5	1201	63.7
1061	40.8	1108	58.8	1155	72.3	1202	63.9
1062	41.8	1109	60.9	1156	73.2	1203	64.1
1063	42.4	1110	63.0	1157	74.1	1204	64.3
1064	43.0	1111	65.0	1158	74.9	1205	66.1
1065	43.4	1112	66.9	1159	75.4	1206	67.9
1066	44.0	1113	68.6	1160	75.5	1207	69.7
1067	44.4	1114	70.1	1161	75.2	1208	71.4
1068	45.0	1115	71.5	1162	74.5	1209	73.1
1069	45.4	1116	72.8	1163	73.3	1210	74.7

<i>Time in s</i>	<i>Speed in km/h</i>	<i>Time in s</i>	<i>Speed in km/h</i>	<i>Time in s</i>	<i>Speed in km/h</i>	<i>Time in s</i>	<i>Speed in km/h</i>
1211	76.2	1260	35.4	1309	72.3	1358	70.8
1212	77.5	1261	32.7	1310	71.9	1359	70.8
1213	78.6	1262	30.0	1311	71.3	1360	70.9
1214	79.7	1263	29.9	1312	70.9	1361	70.9
1215	80.6	1264	30.0	1313	70.5	1362	70.9
1216	81.5	1265	30.2	1314	70.0	1363	70.9
1217	82.2	1266	30.4	1315	69.6	1364	71.0
1218	83.0	1267	30.6	1316	69.2	1365	71.0
1219	83.7	1268	31.6	1317	68.8	1366	71.1
1220	84.4	1269	33.0	1318	68.4	1367	71.2
1221	84.9	1270	33.9	1319	67.9	1368	71.3
1222	85.1	1271	34.8	1320	67.5	1369	71.4
1223	85.2	1272	35.7	1321	67.2	1370	71.5
1224	84.9	1273	36.6	1322	66.8	1371	71.7
1225	84.4	1274	37.5	1323	65.6	1372	71.8
1226	83.6	1275	38.4	1324	63.3	1373	71.9
1227	82.7	1276	39.3	1325	60.2	1374	71.9
1228	81.5	1277	40.2	1326	56.2	1375	71.9
1229	80.1	1278	40.8	1327	52.2	1376	71.9
1230	78.7	1279	41.7	1328	48.4	1377	71.9
1231	77.4	1280	42.4	1329	45.0	1378	71.9
1232	76.2	1281	43.1	1330	41.6	1379	71.9
1233	75.4	1282	43.6	1331	38.6	1380	72.0
1234	74.8	1283	44.2	1332	36.4	1381	72.1
1235	74.3	1284	44.8	1333	34.8	1382	72.4
1236	73.8	1285	45.5	1334	34.2	1383	72.7
1237	73.2	1286	46.3	1335	34.7	1384	73.1
1238	72.4	1287	47.2	1336	36.3	1385	73.4
1239	71.6	1288	48.1	1337	38.5	1386	73.8
1240	70.8	1289	49.1	1338	41.0	1387	74.0
1241	69.9	1290	50.0	1339	43.7	1388	74.1
1242	67.9	1291	51.0	1340	46.5	1389	74.0
1243	65.7	1292	51.9	1341	49.1	1390	73.0
1244	63.5	1293	52.7	1342	51.6	1391	72.0
1245	61.2	1294	53.7	1343	53.9	1392	71.0
1246	59.0	1295	55.0	1344	56.0	1393	70.0
1247	56.8	1296	56.8	1345	57.9	1394	69.0
1248	54.7	1297	58.8	1346	59.7	1395	68.0
1249	52.7	1298	60.9	1347	61.2	1396	67.7
1250	50.9	1299	63.0	1348	62.5	1397	66.7
1251	49.4	1300	65.0	1349	63.5	1398	66.6
1252	48.1	1301	66.9	1350	64.3	1399	66.7
1253	47.1	1302	68.6	1351	65.3	1400	66.8
1254	46.5	1303	70.1	1352	66.3	1401	66.9
1255	46.3	1304	71.0	1353	67.3	1402	66.9
1256	45.1	1305	71.8	1354	68.3	1403	66.9
1257	43.0	1306	72.8	1355	69.3	1404	66.9
1258	40.6	1307	72.9	1356	70.3	1405	66.9
1259	38.1	1308	73.0	1357	70.8	1406	66.9

<i>Time in s</i>	<i>Speed in km/h</i>	<i>Time in s</i>	<i>Speed in km/h</i>	<i>Time in s</i>	<i>Speed in km/h</i>	<i>Time in s</i>	<i>Speed in km/h</i>
1407	66.9	1456	0.0				
1408	67.0	1457	0.0				
1409	67.1	1458	0.0				
1410	67.3	1459	0.0				
1411	67.5	1460	0.0				
1412	67.8	1461	0.0				
1413	68.2	1462	0.0				
1414	68.6	1463	0.0				
1415	69.0	1464	0.0				
1416	69.3	1465	0.0				
1417	69.3	1466	0.0				
1418	69.2	1467	0.0				
1419	68.8	1468	0.0				
1420	68.2	1469	0.0				
1421	67.6	1470	0.0				
1422	67.4	1471	0.0				
1423	67.2	1472	0.0				
1424	66.9	1473	0.0				
1425	66.3	1474	0.0				
1426	65.4	1475	0.0				
1427	64.0	1476	0.0				
1428	62.4	1477	0.0				
1429	60.6						
1430	58.6						
1431	56.7						
1432	54.8						
1433	53.0						
1434	51.3						
1435	49.6						
1436	47.8						
1437	45.5						
1438	42.8						
1439	39.8						
1440	36.5						
1441	33.0						
1442	29.5						
1443	25.8						
1444	22.1						
1445	18.6						
1446	15.3						
1447	12.4						
1448	9.6						
1449	6.6						
1450	3.8						
1451	1.6						
1452	0.0						
1453	0.0						
1454	0.0						
1455	0.0						

Table A1/6

WLTC, Class 2 cycle, phase Extra High₂ (Second 1477 is the end of phase High₂ and the start of Extra High₂)

<i>Time in s</i>	<i>Speed in km/h</i>	<i>Time in s</i>	<i>Speed in km/h</i>	<i>Time in s</i>	<i>Speed in km/h</i>	<i>Time in s</i>	<i>Speed in km/h</i>
1478	0.0	1525	63.4	1572	107.4	1619	113.7
1479	1.1	1526	64.5	1573	108.7	1620	114.1
1480	2.3	1527	65.7	1574	109.9	1621	114.4
1481	4.6	1528	66.9	1575	111.2	1622	114.6
1482	6.5	1529	68.1	1576	112.3	1623	114.7
1483	8.9	1530	69.1	1577	113.4	1624	114.7
1484	10.9	1531	70.0	1578	114.4	1625	114.7
1485	13.5	1532	70.9	1579	115.3	1626	114.6
1486	15.2	1533	71.8	1580	116.1	1627	114.5
1487	17.6	1534	72.6	1581	116.8	1628	114.5
1488	19.3	1535	73.4	1582	117.4	1629	114.5
1489	21.4	1536	74.0	1583	117.7	1630	114.7
1490	23.0	1537	74.7	1584	118.2	1631	115.0
1491	25.0	1538	75.2	1585	118.1	1632	115.6
1492	26.5	1539	75.7	1586	117.7	1633	116.4
1493	28.4	1540	76.4	1587	117.0	1634	117.3
1494	29.8	1541	77.2	1588	116.1	1635	118.2
1495	31.7	1542	78.2	1589	115.2	1636	118.8
1496	33.7	1543	78.9	1590	114.4	1637	119.3
1497	35.8	1544	79.9	1591	113.6	1638	119.6
1498	38.1	1545	81.1	1592	113.0	1639	119.7
1499	40.5	1546	82.4	1593	112.6	1640	119.5
1500	42.2	1547	83.7	1594	112.2	1641	119.3
1501	43.5	1548	85.4	1595	111.9	1642	119.2
1502	44.5	1549	87.0	1596	111.6	1643	119.0
1503	45.2	1550	88.3	1597	111.2	1644	118.8
1504	45.8	1551	89.5	1598	110.7	1645	118.8
1505	46.6	1552	90.5	1599	110.1	1646	118.8
1506	47.4	1553	91.3	1600	109.3	1647	118.8
1507	48.5	1554	92.2	1601	108.4	1648	118.8
1508	49.7	1555	93.0	1602	107.4	1649	118.9
1509	51.3	1556	93.8	1603	106.7	1650	119.0
1510	52.9	1557	94.6	1604	106.3	1651	119.0
1511	54.3	1558	95.3	1605	106.2	1652	119.1
1512	55.6	1559	95.9	1606	106.4	1653	119.2
1513	56.8	1560	96.6	1607	107.0	1654	119.4
1514	57.9	1561	97.4	1608	107.5	1655	119.6
1515	58.9	1562	98.1	1609	107.9	1656	119.9
1516	59.7	1563	98.7	1610	108.4	1657	120.1
1517	60.3	1564	99.5	1611	108.9	1658	120.3
1518	60.7	1565	100.3	1612	109.5	1659	120.4
1519	60.9	1566	101.1	1613	110.2	1660	120.5
1520	61.0	1567	101.9	1614	110.9	1661	120.5
1521	61.1	1568	102.8	1615	111.6	1662	120.5
1522	61.4	1569	103.8	1616	112.2	1663	120.5
1523	61.8	1570	105.0	1617	112.8	1664	120.4
1524	62.5	1571	106.1	1618	113.3	1665	120.3

<i>Time in s</i>	<i>Speed in km/h</i>	<i>Time in s</i>	<i>Speed in km/h</i>	<i>Time in s</i>	<i>Speed in km/h</i>	<i>Time in s</i>	<i>Speed in km/h</i>
1666	120.1	1715	120.4	1764	82.6		
1667	119.9	1716	120.8	1765	81.9		
1668	119.6	1717	121.1	1766	81.1		
1669	119.5	1718	121.6	1767	80.0		
1670	119.4	1719	121.8	1768	78.7		
1671	119.3	1720	122.1	1769	76.9		
1672	119.3	1721	122.4	1770	74.6		
1673	119.4	1722	122.7	1771	72.0		
1674	119.5	1723	122.8	1772	69.0		
1675	119.5	1724	123.1	1773	65.6		
1676	119.6	1725	123.1	1774	62.1		
1677	119.6	1726	122.8	1775	58.5		
1678	119.6	1727	122.3	1776	54.7		
1679	119.4	1728	121.3	1777	50.9		
1680	119.3	1729	119.9	1778	47.3		
1681	119.0	1730	118.1	1779	43.8		
1682	118.8	1731	115.9	1780	40.4		
1683	118.7	1732	113.5	1781	37.4		
1684	118.8	1733	111.1	1782	34.3		
1685	119.0	1734	108.6	1783	31.3		
1686	119.2	1735	106.2	1784	28.3		
1687	119.6	1736	104.0	1785	25.2		
1688	120.0	1737	101.1	1786	22.0		
1689	120.3	1738	98.3	1787	18.9		
1690	120.5	1739	95.7	1788	16.1		
1691	120.7	1740	93.5	1789	13.4		
1692	120.9	1741	91.5	1790	11.1		
1693	121.0	1742	90.7	1791	8.9		
1694	121.1	1743	90.4	1792	6.9		
1695	121.2	1744	90.2	1793	4.9		
1696	121.3	1745	90.2	1794	2.8		
1697	121.4	1746	90.1	1795	0.0		
1698	121.5	1747	90.0	1796	0.0		
1699	121.5	1748	89.8	1797	0.0		
1700	121.5	1749	89.6	1798	0.0		
1701	121.4	1750	89.4	1799	0.0		
1702	121.3	1751	89.2	1800	0.0		
1703	121.1	1752	88.9				
1704	120.9	1753	88.5				
1705	120.6	1754	88.1				
1706	120.4	1755	87.6				
1707	120.2	1756	87.1				
1708	120.1	1757	86.6				
1709	119.9	1758	86.1				
1710	119.8	1759	85.5				
1711	119.8	1760	85.0				
1712	119.9	1761	84.4				
1713	120.0	1762	83.8				
1714	120.2	1763	83.2				

6. WLTC Class 3 cycle

Figure A1/7

WLTC, Class 3 cycle, phase Low₃

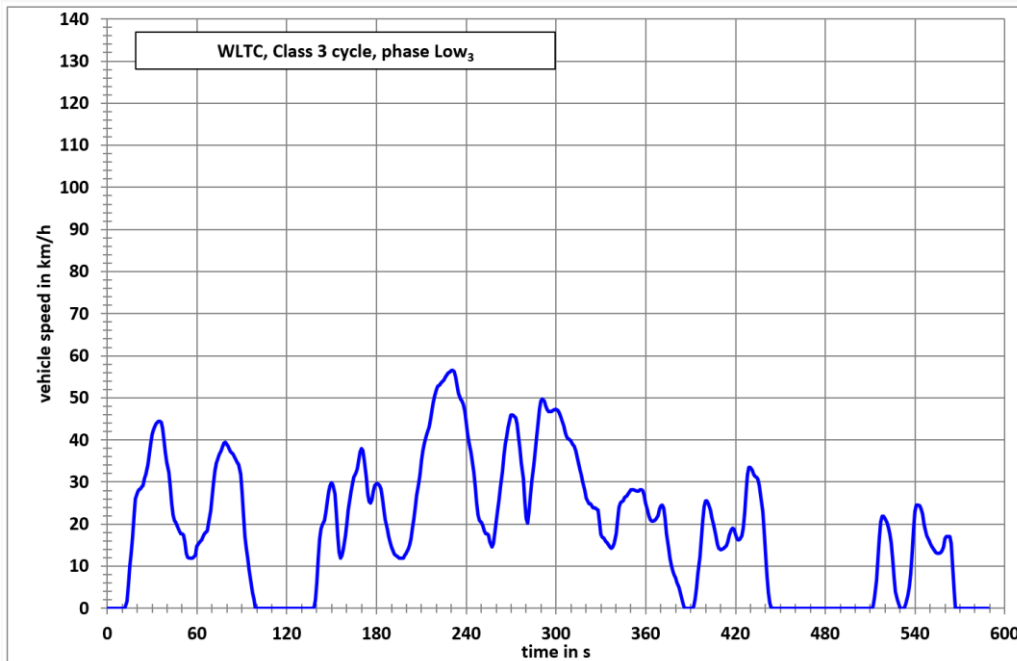


Figure A1/8

WLTC, Class 3a cycle, phase Medium_{3a}

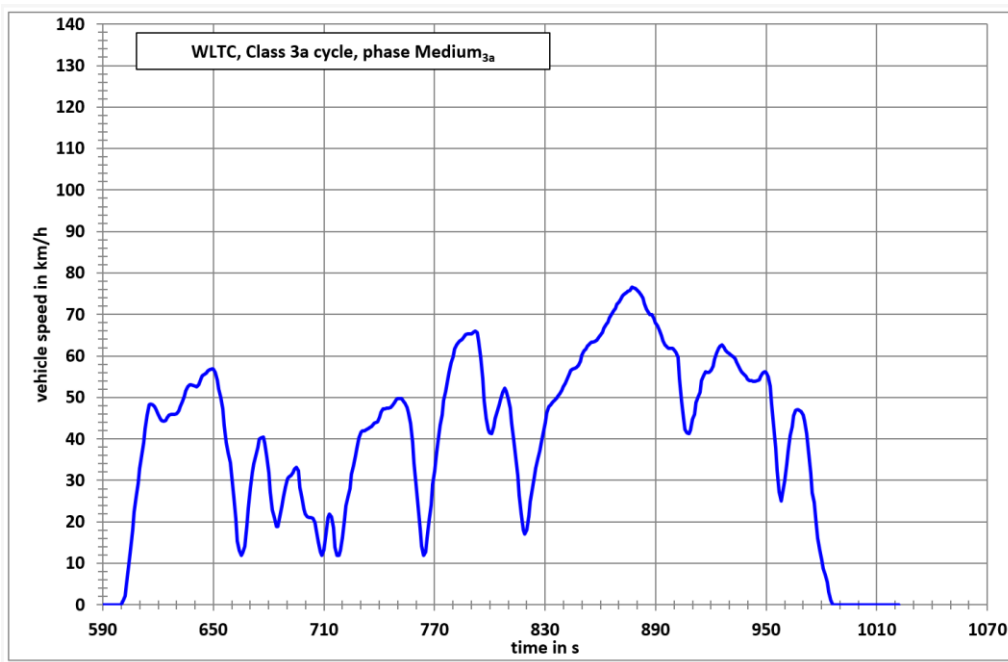


Figure A1/9
WLTC, Class 3b cycle, phase Medium_{3b}

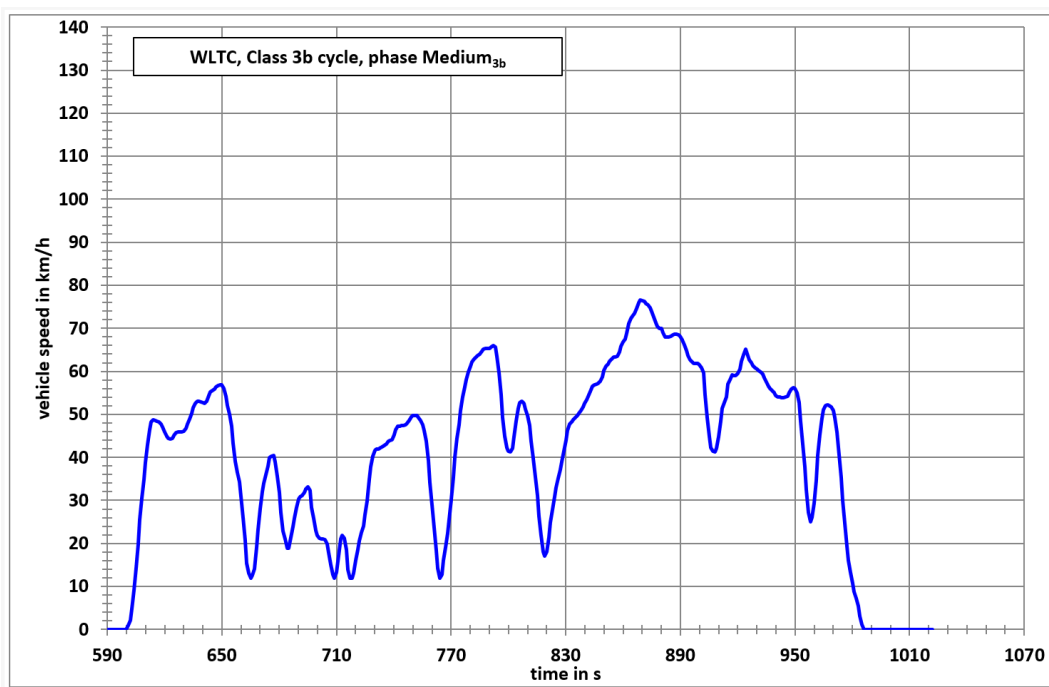


Figure A1/10
WLTC, Class 3a cycle, phase High_{3a}

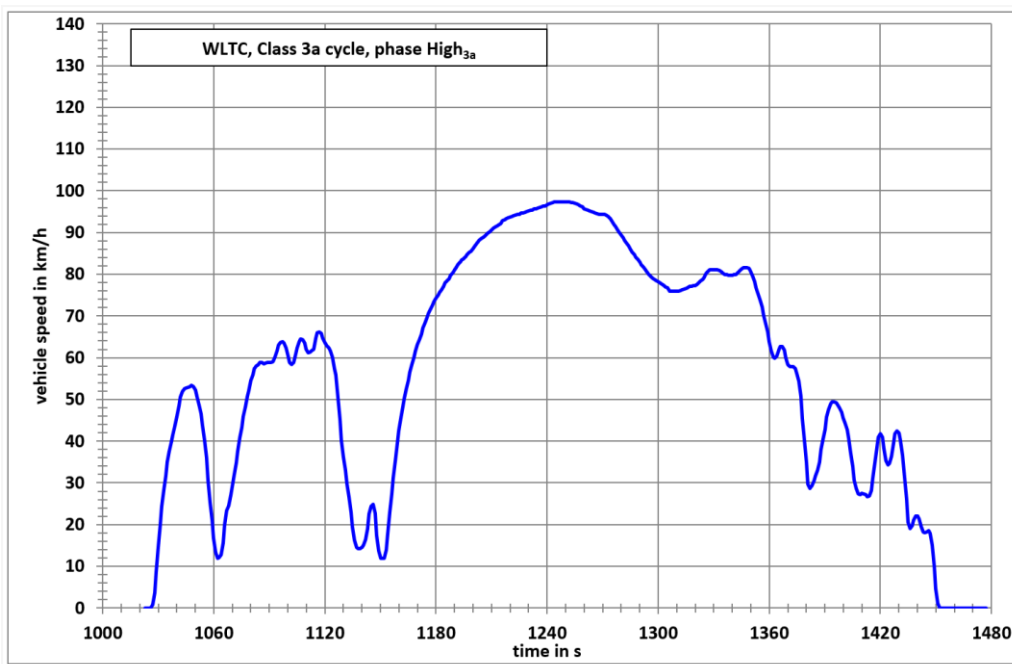


Figure A1/11
WLTC, Class 3b cycle, phase High_{3b}

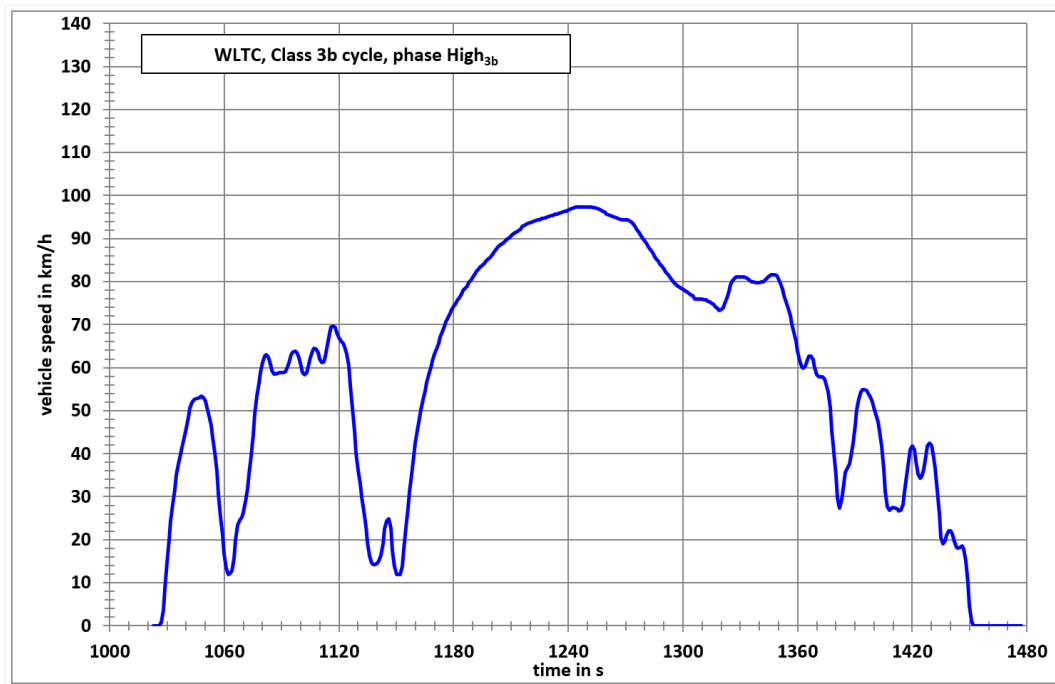


Figure A1/12
WLTC, Class 3 cycle, phase Extra High₃

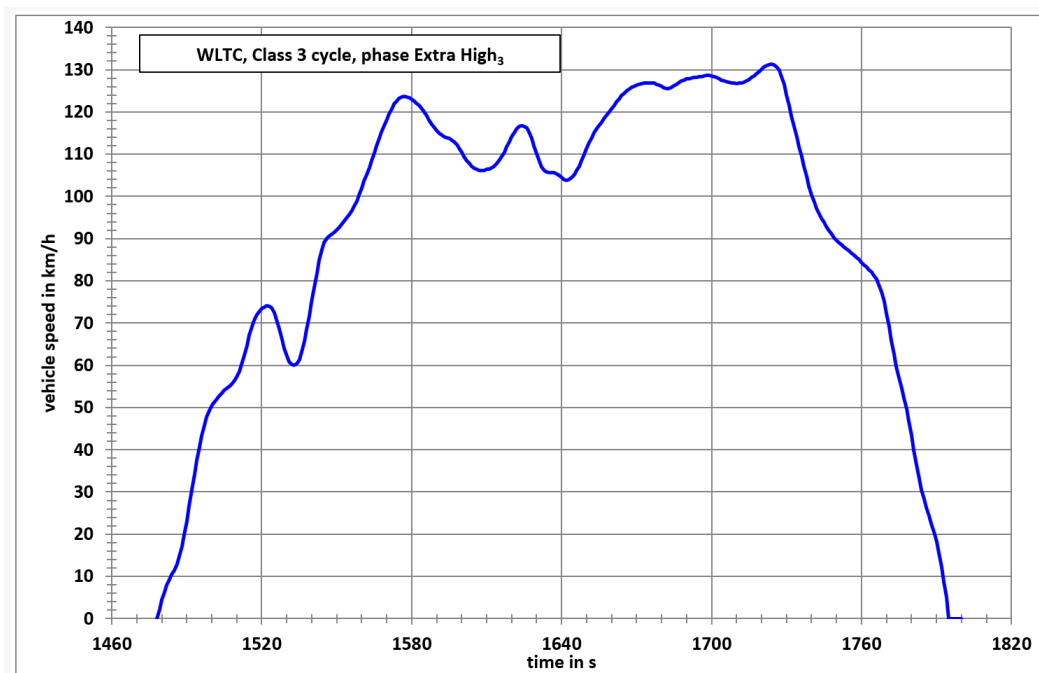


Table A1/7

WLTC, Class 3 cycle, phase Low₃ (Second 589 is the end of phase Low₃ and the start of phase Medium₃)

<i>Time in s</i>	<i>Speed in km/h</i>	<i>Time in s</i>	<i>Speed in km/h</i>	<i>Time in s</i>	<i>Speed in km/h</i>	<i>Time in s</i>	<i>Speed in km/h</i>
0	0.0	47	19.5	94	12.0	141	11.7
1	0.0	48	18.4	95	9.1	142	16.4
2	0.0	49	17.8	96	5.8	143	18.9
3	0.0	50	17.8	97	3.6	144	19.9
4	0.0	51	17.4	98	2.2	145	20.8
5	0.0	52	15.7	99	0.0	146	22.8
6	0.0	53	13.1	100	0.0	147	25.4
7	0.0	54	12.1	101	0.0	148	27.7
8	0.0	55	12.0	102	0.0	149	29.2
9	0.0	56	12.0	103	0.0	150	29.8
10	0.0	57	12.0	104	0.0	151	29.4
11	0.0	58	12.3	105	0.0	152	27.2
12	0.2	59	12.6	106	0.0	153	22.6
13	1.7	60	14.7	107	0.0	154	17.3
14	5.4	61	15.3	108	0.0	155	13.3
15	9.9	62	15.9	109	0.0	156	12.0
16	13.1	63	16.2	110	0.0	157	12.6
17	16.9	64	17.1	111	0.0	158	14.1
18	21.7	65	17.8	112	0.0	159	17.2
19	26.0	66	18.1	113	0.0	160	20.1
20	27.5	67	18.4	114	0.0	161	23.4
21	28.1	68	20.3	115	0.0	162	25.5
22	28.3	69	23.2	116	0.0	163	27.6
23	28.8	70	26.5	117	0.0	164	29.5
24	29.1	71	29.8	118	0.0	165	31.1
25	30.8	72	32.6	119	0.0	166	32.1
26	31.9	73	34.4	120	0.0	167	33.2
27	34.1	74	35.5	121	0.0	168	35.2
28	36.6	75	36.4	122	0.0	169	37.2
29	39.1	76	37.4	123	0.0	170	38.0
30	41.3	77	38.5	124	0.0	171	37.4
31	42.5	78	39.3	125	0.0	172	35.1
32	43.3	79	39.5	126	0.0	173	31.0
33	43.9	80	39.0	127	0.0	174	27.1
34	44.4	81	38.5	128	0.0	175	25.3
35	44.5	82	37.3	129	0.0	176	25.1
36	44.2	83	37.0	130	0.0	177	25.9
37	42.7	84	36.7	131	0.0	178	27.8
38	39.9	85	35.9	132	0.0	179	29.2
39	37.0	86	35.3	133	0.0	180	29.6
40	34.6	87	34.6	134	0.0	181	29.5
41	32.3	88	34.2	135	0.0	182	29.2
42	29.0	89	31.9	136	0.0	183	28.3
43	25.1	90	27.3	137	0.0	184	26.1
44	22.2	91	22.0	138	0.2	185	23.6
45	20.9	92	17.0	139	1.9	186	21.0
46	20.4	93	14.2	140	6.1	187	18.9

<i>Time in s</i>	<i>Speed in km/h</i>	<i>Time in s</i>	<i>Speed in km/h</i>	<i>Time in s</i>	<i>Speed in km/h</i>	<i>Time in s</i>	<i>Speed in km/h</i>
188	17.1	237	49.2	286	37.4	335	15.0
189	15.7	238	48.4	287	40.7	336	14.5
190	14.5	239	46.9	288	44.0	337	14.3
191	13.7	240	44.3	289	47.3	338	14.5
192	12.9	241	41.5	290	49.2	339	15.4
193	12.5	242	39.5	291	49.8	340	17.8
194	12.2	243	37.0	292	49.2	341	21.1
195	12.0	244	34.6	293	48.1	342	24.1
196	12.0	245	32.3	294	47.3	343	25.0
197	12.0	246	29.0	295	46.8	344	25.3
198	12.0	247	25.1	296	46.7	345	25.5
199	12.5	248	22.2	297	46.8	346	26.4
200	13.0	249	20.9	298	47.1	347	26.6
201	14.0	250	20.4	299	47.3	348	27.1
202	15.0	251	19.5	300	47.3	349	27.7
203	16.5	252	18.4	301	47.1	350	28.1
204	19.0	253	17.8	302	46.6	351	28.2
205	21.2	254	17.8	303	45.8	352	28.1
206	23.8	255	17.4	304	44.8	353	28.0
207	26.9	256	15.7	305	43.3	354	27.9
208	29.6	257	14.5	306	41.8	355	27.9
209	32.0	258	15.4	307	40.8	356	28.1
210	35.2	259	17.9	308	40.3	357	28.2
211	37.5	260	20.6	309	40.1	358	28.0
212	39.2	261	23.2	310	39.7	359	26.9
213	40.5	262	25.7	311	39.2	360	25.0
214	41.6	263	28.7	312	38.5	361	23.2
215	43.1	264	32.5	313	37.4	362	21.9
216	45.0	265	36.1	314	36.0	363	21.1
217	47.1	266	39.0	315	34.4	364	20.7
218	49.0	267	40.8	316	33.0	365	20.7
219	50.6	268	42.9	317	31.7	366	20.8
220	51.8	269	44.4	318	30.0	367	21.2
221	52.7	270	45.9	319	28.0	368	22.1
222	53.1	271	46.0	320	26.1	369	23.5
223	53.5	272	45.6	321	25.6	370	24.3
224	53.8	273	45.3	322	24.9	371	24.5
225	54.2	274	43.7	323	24.9	372	23.8
226	54.8	275	40.8	324	24.3	373	21.3
227	55.3	276	38.0	325	23.9	374	17.7
228	55.8	277	34.4	326	23.9	375	14.4
229	56.2	278	30.9	327	23.6	376	11.9
230	56.5	279	25.5	328	23.3	377	10.2
231	56.5	280	21.4	329	20.5	378	8.9
232	56.2	281	20.2	330	17.5	379	8.0
233	54.9	282	22.9	331	16.9	380	7.2
234	52.9	283	26.6	332	16.7	381	6.1
235	51.0	284	30.2	333	15.9	382	4.9
236	49.8	285	34.1	334	15.6	383	3.7

<i>Time in s</i>	<i>Speed in km/h</i>	<i>Time in s</i>	<i>Speed in km/h</i>	<i>Time in s</i>	<i>Speed in km/h</i>	<i>Time in s</i>	<i>Speed in km/h</i>
384	2.3	433	31.3	482	0.0	531	0.0
385	0.9	434	31.1	483	0.0	532	0.0
386	0.0	435	30.6	484	0.0	533	0.2
387	0.0	436	29.2	485	0.0	534	1.2
388	0.0	437	26.7	486	0.0	535	3.2
389	0.0	438	23.0	487	0.0	536	5.2
390	0.0	439	18.2	488	0.0	537	8.2
391	0.0	440	12.9	489	0.0	538	13
392	0.5	441	7.7	490	0.0	539	18.8
393	2.1	442	3.8	491	0.0	540	23.1
394	4.8	443	1.3	492	0.0	541	24.5
395	8.3	444	0.2	493	0.0	542	24.5
396	12.3	445	0.0	494	0.0	543	24.3
397	16.6	446	0.0	495	0.0	544	23.6
398	20.9	447	0.0	496	0.0	545	22.3
399	24.2	448	0.0	497	0.0	546	20.1
400	25.6	449	0.0	498	0.0	547	18.5
401	25.6	450	0.0	499	0.0	548	17.2
402	24.9	451	0.0	500	0.0	549	16.3
403	23.3	452	0.0	501	0.0	550	15.4
404	21.6	453	0.0	502	0.0	551	14.7
405	20.2	454	0.0	503	0.0	552	14.3
406	18.7	455	0.0	504	0.0	553	13.7
407	17.0	456	0.0	505	0.0	554	13.3
408	15.3	457	0.0	506	0.0	555	13.1
409	14.2	458	0.0	507	0.0	556	13.1
410	13.9	459	0.0	508	0.0	557	13.3
411	14.0	460	0.0	509	0.0	558	13.8
412	14.2	461	0.0	510	0.0	559	14.5
413	14.5	462	0.0	511	0.0	560	16.5
414	14.9	463	0.0	512	0.5	561	17.0
415	15.9	464	0.0	513	2.5	562	17.0
416	17.4	465	0.0	514	6.6	563	17.0
417	18.7	466	0.0	515	11.8	564	15.4
418	19.1	467	0.0	516	16.8	565	10.1
419	18.8	468	0.0	517	20.5	566	4.8
420	17.6	469	0.0	518	21.9	567	0.0
421	16.6	470	0.0	519	21.9	568	0.0
422	16.2	471	0.0	520	21.3	569	0.0
423	16.4	472	0.0	521	20.3	570	0.0
424	17.2	473	0.0	522	19.2	571	0.0
425	19.1	474	0.0	523	17.8	572	0.0
426	22.6	475	0.0	524	15.5	573	0.0
427	27.4	476	0.0	525	11.9	574	0.0
428	31.6	477	0.0	526	7.6	575	0.0
429	33.4	478	0.0	527	4.0	576	0.0
430	33.5	479	0.0	528	2.0	577	0.0
431	32.8	480	0.0	529	1.0	578	0.0
432	31.9	481	0.0	530	0.0	579	0.0

<i>Time in s</i>	<i>Speed in km/h</i>	<i>Time in s</i>	<i>Speed in km/h</i>	<i>Time in s</i>	<i>Speed in km/h</i>	<i>Time in s</i>	<i>Speed in km/h</i>
580	0.0						
581	0.0						
582	0.0						
583	0.0						
584	0.0						
585	0.0						
586	0.0						
587	0.0						
588	0.0						
589	0.0						

Table A1/8

WLTC, Class 3a cycle, phase Medium_{3a} (Second 589 is the end of phase Low₃ and the start of phase Medium_{3a})

<i>Time in s</i>	<i>Speed in km/h</i>	<i>Time in s</i>	<i>Speed in km/h</i>	<i>Time in s</i>	<i>Speed in km/h</i>	<i>Time in s</i>	<i>Speed in km/h</i>
590	0.0	637	53.0	684	18.9	731	41.9
591	0.0	638	53.0	685	18.9	732	42.0
592	0.0	639	52.9	686	21.3	733	42.2
593	0.0	640	52.7	687	23.9	734	42.4
594	0.0	641	52.6	688	25.9	735	42.7
595	0.0	642	53.1	689	28.4	736	43.1
596	0.0	643	54.3	690	30.3	737	43.7
597	0.0	644	55.2	691	30.9	738	44.0
598	0.0	645	55.5	692	31.1	739	44.1
599	0.0	646	55.9	693	31.8	740	45.3
600	0.0	647	56.3	694	32.7	741	46.4
601	1.0	648	56.7	695	33.2	742	47.2
602	2.1	649	56.9	696	32.4	743	47.3
603	5.2	650	56.8	697	28.3	744	47.4
604	9.2	651	56.0	698	25.8	745	47.4
605	13.5	652	54.2	699	23.1	746	47.5
606	18.1	653	52.1	700	21.8	747	47.9
607	22.3	654	50.1	701	21.2	748	48.6
608	26.0	655	47.2	702	21.0	749	49.4
609	29.3	656	43.2	703	21.0	750	49.8
610	32.8	657	39.2	704	20.9	751	49.8
611	36.0	658	36.5	705	19.9	752	49.7
612	39.2	659	34.3	706	17.9	753	49.3
613	42.5	660	31.0	707	15.1	754	48.5
614	45.7	661	26.0	708	12.8	755	47.6
615	48.2	662	20.7	709	12.0	756	46.3
616	48.4	663	15.4	710	13.2	757	43.7
617	48.2	664	13.1	711	17.1	758	39.3
618	47.8	665	12.0	712	21.1	759	34.1
619	47.0	666	12.5	713	21.8	760	29.0
620	45.9	667	14.0	714	21.2	761	23.7
621	44.9	668	19.0	715	18.5	762	18.4
622	44.4	669	23.2	716	13.9	763	14.3
623	44.3	670	28.0	717	12.0	764	12.0
624	44.5	671	32.0	718	12.0	765	12.8
625	45.1	672	34.0	719	13.0	766	16.0
626	45.7	673	36.0	720	16.3	767	20.4
627	46.0	674	38.0	721	20.5	768	24.0
628	46.0	675	40.0	722	23.9	769	29.0
629	46.0	676	40.3	723	26.0	770	32.2
630	46.1	677	40.5	724	28.0	771	36.8
631	46.7	678	39.0	725	31.5	772	39.4
632	47.7	679	35.7	726	33.4	773	43.2
633	48.9	680	31.8	727	36.0	774	45.8
634	50.3	681	27.1	728	37.8	775	49.2
635	51.6	682	22.8	729	40.2	776	51.4
636	52.6	683	21.1	730	41.6	777	54.2

<i>Time in s</i>	<i>Speed in km/h</i>	<i>Time in s</i>	<i>Speed in km/h</i>	<i>Time in s</i>	<i>Speed in km/h</i>	<i>Time in s</i>	<i>Speed in km/h</i>
778	56.0	827	37.1	876	75.8	925	62.3
779	58.3	828	38.9	877	76.6	926	62.7
780	59.8	829	41.4	878	76.5	927	62.0
781	61.7	830	44.0	879	76.2	928	61.3
782	62.7	831	46.3	880	75.8	929	60.9
783	63.3	832	47.7	881	75.4	930	60.5
784	63.6	833	48.2	882	74.8	931	60.2
785	64.0	834	48.7	883	73.9	932	59.8
786	64.7	835	49.3	884	72.7	933	59.4
787	65.2	836	49.8	885	71.3	934	58.6
788	65.3	837	50.2	886	70.4	935	57.5
789	65.3	838	50.9	887	70.0	936	56.6
790	65.4	839	51.8	888	70.0	937	56.0
791	65.7	840	52.5	889	69.0	938	55.5
792	66.0	841	53.3	890	68.0	939	55.0
793	65.6	842	54.5	891	67.3	940	54.4
794	63.5	843	55.7	892	66.2	941	54.1
795	59.7	844	56.5	893	64.8	942	54.0
796	54.6	845	56.8	894	63.6	943	53.9
797	49.3	846	57.0	895	62.6	944	53.9
798	44.9	847	57.2	896	62.1	945	54.0
799	42.3	848	57.7	897	61.9	946	54.2
800	41.4	849	58.7	898	61.9	947	55.0
801	41.3	850	60.1	899	61.8	948	55.8
802	43.0	851	61.1	900	61.5	949	56.2
803	45.0	852	61.7	901	60.9	950	56.1
804	46.5	853	62.3	902	59.7	951	55.1
805	48.3	854	62.9	903	54.6	952	52.7
806	49.5	855	63.3	904	49.3	953	48.4
807	51.2	856	63.4	905	44.9	954	43.1
808	52.2	857	63.5	906	42.3	955	37.8
809	51.6	858	63.9	907	41.4	956	32.5
810	49.7	859	64.4	908	41.3	957	27.2
811	47.4	860	65.0	909	42.1	958	25.1
812	43.7	861	65.6	910	44.7	959	27.0
813	39.7	862	66.6	911	46.0	960	29.8
814	35.5	863	67.4	912	48.8	961	33.8
815	31.1	864	68.2	913	50.1	962	37.0
816	26.3	865	69.1	914	51.3	963	40.7
817	21.9	866	70.0	915	54.1	964	43.0
818	18.0	867	70.8	916	55.2	965	45.6
819	17.0	868	71.5	917	56.2	966	46.9
820	18.0	869	72.4	918	56.1	967	47.0
821	21.4	870	73.0	919	56.1	968	46.9
822	24.8	871	73.7	920	56.5	969	46.5
823	27.9	872	74.4	921	57.5	970	45.8
824	30.8	873	74.9	922	59.2	971	44.3
825	33.0	874	75.3	923	60.7	972	41.3
826	35.1	875	75.6	924	61.8	973	36.5

<i>Time in s</i>	<i>Speed in km/h</i>	<i>Time in s</i>	<i>Speed in km/h</i>	<i>Time in s</i>	<i>Speed in km/h</i>	<i>Time in s</i>	<i>Speed in km/h</i>
974	31.7						
975	27.0						
976	24.7						
977	19.3						
978	16.0						
979	13.2						
980	10.7						
981	8.8						
982	7.2						
983	5.5						
984	3.2						
985	1.1						
986	0.0						
987	0.0						
988	0.0						
989	0.0						
990	0.0						
991	0.0						
992	0.0						
993	0.0						
994	0.0						
995	0.0						
996	0.0						
997	0.0						
998	0.0						
999	0.0						
1000	0.0						
1001	0.0						
1002	0.0						
1003	0.0						
1004	0.0						
1005	0.0						
1006	0.0						
1007	0.0						
1008	0.0						
1009	0.0						
1010	0.0						
1011	0.0						
1012	0.0						
1013	0.0						
1014	0.0						
1015	0.0						
1016	0.0						
1017	0.0						
1018	0.0						
1019	0.0						
1020	0.0						
1021	0.0						
1022	0.0						

Table A1/9

WLTC, Class 3b cycle, phase Medium_{3b} (Second 589 is the end of phase Low₃ and the start of phase Medium_{3b})

<i>Time in s</i>	<i>Speed in km/h</i>	<i>Time in s</i>	<i>Speed in km/h</i>	<i>Time in s</i>	<i>Speed in km/h</i>	<i>Time in s</i>	<i>Speed in km/h</i>
590	0.0	637	53.0	684	18.9	731	41.9
591	0.0	638	53.0	685	18.9	732	42.0
592	0.0	639	52.9	686	21.3	733	42.2
593	0.0	640	52.7	687	23.9	734	42.4
594	0.0	641	52.6	688	25.9	735	42.7
595	0.0	642	53.1	689	28.4	736	43.1
596	0.0	643	54.3	690	30.3	737	43.7
597	0.0	644	55.2	691	30.9	738	44.0
598	0.0	645	55.5	692	31.1	739	44.1
599	0.0	646	55.9	693	31.8	740	45.3
600	0.0	647	56.3	694	32.7	741	46.4
601	1.0	648	56.7	695	33.2	742	47.2
602	2.1	649	56.9	696	32.4	743	47.3
603	4.8	650	56.8	697	28.3	744	47.4
604	9.1	651	56.0	698	25.8	745	47.4
605	14.2	652	54.2	699	23.1	746	47.5
606	19.8	653	52.1	700	21.8	747	47.9
607	25.5	654	50.1	701	21.2	748	48.6
608	30.5	655	47.2	702	21.0	749	49.4
609	34.8	656	43.2	703	21.0	750	49.8
610	38.8	657	39.2	704	20.9	751	49.8
611	42.9	658	36.5	705	19.9	752	49.7
612	46.4	659	34.3	706	17.9	753	49.3
613	48.3	660	31.0	707	15.1	754	48.5
614	48.7	661	26.0	708	12.8	755	47.6
615	48.5	662	20.7	709	12.0	756	46.3
616	48.4	663	15.4	710	13.2	757	43.7
617	48.2	664	13.1	711	17.1	758	39.3
618	47.8	665	12.0	712	21.1	759	34.1
619	47.0	666	12.5	713	21.8	760	29.0
620	45.9	667	14.0	714	21.2	761	23.7
621	44.9	668	19.0	715	18.5	762	18.4
622	44.4	669	23.2	716	13.9	763	14.3
623	44.3	670	28.0	717	12.0	764	12.0
624	44.5	671	32.0	718	12.0	765	12.8
625	45.1	672	34.0	719	13.0	766	16.0
626	45.7	673	36.0	720	16.0	767	19.1
627	46.0	674	38.0	721	18.5	768	22.4
628	46.0	675	40.0	722	20.6	769	25.6
629	46.0	676	40.3	723	22.5	770	30.1
630	46.1	677	40.5	724	24.0	771	35.3
631	46.7	678	39.0	725	26.6	772	39.9
632	47.7	679	35.7	726	29.9	773	44.5
633	48.9	680	31.8	727	34.8	774	47.5
634	50.3	681	27.1	728	37.8	775	50.9
635	51.6	682	22.8	729	40.2	776	54.1
636	52.6	683	21.1	730	41.6	777	56.3

<i>Time in s</i>	<i>Speed in km/h</i>	<i>Time in s</i>	<i>Speed in km/h</i>	<i>Time in s</i>	<i>Speed in km/h</i>	<i>Time in s</i>	<i>Speed in km/h</i>
778	58.1	827	37.1	876	72.7	925	64.1
779	59.8	828	38.9	877	71.3	926	62.7
780	61.1	829	41.4	878	70.4	927	62.0
781	62.1	830	44.0	879	70.0	928	61.3
782	62.8	831	46.3	880	70.0	929	60.9
783	63.3	832	47.7	881	69.0	930	60.5
784	63.6	833	48.2	882	68.0	931	60.2
785	64.0	834	48.7	883	68.0	932	59.8
786	64.7	835	49.3	884	68.0	933	59.4
787	65.2	836	49.8	885	68.1	934	58.6
788	65.3	837	50.2	886	68.4	935	57.5
789	65.3	838	50.9	887	68.6	936	56.6
790	65.4	839	51.8	888	68.7	937	56.0
791	65.7	840	52.5	889	68.5	938	55.5
792	66.0	841	53.3	890	68.1	939	55.0
793	65.6	842	54.5	891	67.3	940	54.4
794	63.5	843	55.7	892	66.2	941	54.1
795	59.7	844	56.5	893	64.8	942	54.0
796	54.6	845	56.8	894	63.6	943	53.9
797	49.3	846	57.0	895	62.6	944	53.9
798	44.9	847	57.2	896	62.1	945	54.0
799	42.3	848	57.7	897	61.9	946	54.2
800	41.4	849	58.7	898	61.9	947	55.0
801	41.3	850	60.1	899	61.8	948	55.8
802	42.1	851	61.1	900	61.5	949	56.2
803	44.7	852	61.7	901	60.9	950	56.1
804	48.4	853	62.3	902	59.7	951	55.1
805	51.4	854	62.9	903	54.6	952	52.7
806	52.7	855	63.3	904	49.3	953	48.4
807	53.0	856	63.4	905	44.9	954	43.1
808	52.5	857	63.5	906	42.3	955	37.8
809	51.3	858	64.5	907	41.4	956	32.5
810	49.7	859	65.8	908	41.3	957	27.2
811	47.4	860	66.8	909	42.1	958	25.1
812	43.7	861	67.4	910	44.7	959	26.0
813	39.7	862	68.8	911	48.4	960	29.3
814	35.5	863	71.1	912	51.4	961	34.6
815	31.1	864	72.3	913	52.7	962	40.4
816	26.3	865	72.8	914	54.0	963	45.3
817	21.9	866	73.4	915	57.0	964	49.0
818	18.0	867	74.6	916	58.1	965	51.1
819	17.0	868	76.0	917	59.2	966	52.1
820	18.0	869	76.6	918	59.0	967	52.2
821	21.4	870	76.5	919	59.1	968	52.1
822	24.8	871	76.2	920	59.5	969	51.7
823	27.9	872	75.8	921	60.5	970	50.9
824	30.8	873	75.4	922	62.3	971	49.2
825	33.0	874	74.8	923	63.9	972	45.9
826	35.1	875	73.9	924	65.1	973	40.6

<i>Time in s</i>	<i>Speed in km/h</i>	<i>Time in s</i>	<i>Speed in km/h</i>	<i>Time in s</i>	<i>Speed in km/h</i>	<i>Time in s</i>	<i>Speed in km/h</i>
974	35.3						
975	30.0						
976	24.7						
977	19.3						
978	16.0						
979	13.2						
980	10.7						
981	8.8						
982	7.2						
983	5.5						
984	3.2						
985	1.1						
986	0.0						
987	0.0						
988	0.0						
989	0.0						
990	0.0						
991	0.0						
992	0.0						
993	0.0						
994	0.0						
995	0.0						
996	0.0						
997	0.0						
998	0.0						
999	0.0						
1000	0.0						
1001	0.0						
1002	0.0						
1003	0.0						
1004	0.0						
1005	0.0						
1006	0.0						
1007	0.0						
1008	0.0						
1009	0.0						
1010	0.0						
1011	0.0						
1012	0.0						
1013	0.0						
1014	0.0						
1015	0.0						
1016	0.0						
1017	0.0						
1018	0.0						
1019	0.0						
1020	0.0						
1021	0.0						
1022	0.0						

Table A1/10
WLTC, Class 3a cycle, phase High_{3a} (Second 1022 is the start of this phase)

<i>Time in s</i>	<i>Speed in km/h</i>	<i>Time in s</i>	<i>Speed in km/h</i>	<i>Time in s</i>	<i>Speed in km/h</i>	<i>Time in s</i>	<i>Speed in km/h</i>
1023	0.0	1070	29.0	1117	66.2	1164	52.6
1024	0.0	1071	32.0	1118	65.8	1165	54.5
1025	0.0	1072	34.8	1119	64.7	1166	56.6
1026	0.0	1073	37.7	1120	63.6	1167	58.3
1027	0.8	1074	40.8	1121	62.9	1168	60.0
1028	3.6	1075	43.2	1122	62.4	1169	61.5
1029	8.6	1076	46.0	1123	61.7	1170	63.1
1030	14.6	1077	48.0	1124	60.1	1171	64.3
1031	20.0	1078	50.7	1125	57.3	1172	65.7
1032	24.4	1079	52.0	1126	55.8	1173	67.1
1033	28.2	1080	54.5	1127	50.5	1174	68.3
1034	31.7	1081	55.9	1128	45.2	1175	69.7
1035	35.0	1082	57.4	1129	40.1	1176	70.6
1036	37.6	1083	58.1	1130	36.2	1177	71.6
1037	39.7	1084	58.4	1131	32.9	1178	72.6
1038	41.5	1085	58.8	1132	29.8	1179	73.5
1039	43.6	1086	58.8	1133	26.6	1180	74.2
1040	46.0	1087	58.6	1134	23.0	1181	74.9
1041	48.4	1088	58.7	1135	19.4	1182	75.6
1042	50.5	1089	58.8	1136	16.3	1183	76.3
1043	51.9	1090	58.8	1137	14.6	1184	77.1
1044	52.6	1091	58.8	1138	14.2	1185	77.9
1045	52.8	1092	59.1	1139	14.3	1186	78.5
1046	52.9	1093	60.1	1140	14.6	1187	79.0
1047	53.1	1094	61.7	1141	15.1	1188	79.7
1048	53.3	1095	63.0	1142	16.4	1189	80.3
1049	53.1	1096	63.7	1143	19.1	1190	81.0
1050	52.3	1097	63.9	1144	22.5	1191	81.6
1051	50.7	1098	63.5	1145	24.4	1192	82.4
1052	48.8	1099	62.3	1146	24.8	1193	82.9
1053	46.5	1100	60.3	1147	22.7	1194	83.4
1054	43.8	1101	58.9	1148	17.4	1195	83.8
1055	40.3	1102	58.4	1149	13.8	1196	84.2
1056	36.0	1103	58.8	1150	12.0	1197	84.7
1057	30.7	1104	60.2	1151	12.0	1198	85.2
1058	25.4	1105	62.3	1152	12.0	1199	85.6
1059	21.0	1106	63.9	1153	13.9	1200	86.3
1060	16.7	1107	64.5	1154	17.7	1201	86.8
1061	13.4	1108	64.4	1155	22.8	1202	87.4
1062	12.0	1109	63.5	1156	27.3	1203	88.0
1063	12.1	1110	62.0	1157	31.2	1204	88.3
1064	12.8	1111	61.2	1158	35.2	1205	88.7
1065	15.6	1112	61.3	1159	39.4	1206	89.0
1066	19.9	1113	61.7	1160	42.5	1207	89.3
1067	23.4	1114	62.0	1161	45.4	1208	89.8
1068	24.6	1115	64.6	1162	48.2	1209	90.2
1069	27.0	1116	66.0	1163	50.3	1210	90.6

<i>Time in s</i>	<i>Speed in km/h</i>	<i>Time in s</i>	<i>Speed in km/h</i>	<i>Time in s</i>	<i>Speed in km/h</i>	<i>Time in s</i>	<i>Speed in km/h</i>
1211	91.0	1260	95.7	1309	75.9	1358	68.2
1212	91.3	1261	95.5	1310	76.0	1359	66.1
1213	91.6	1262	95.3	1311	76.0	1360	63.8
1214	91.9	1263	95.2	1312	76.1	1361	61.6
1215	92.2	1264	95.0	1313	76.3	1362	60.2
1216	92.8	1265	94.9	1314	76.5	1363	59.8
1217	93.1	1266	94.7	1315	76.6	1364	60.4
1218	93.3	1267	94.5	1316	76.8	1365	61.8
1219	93.5	1268	94.4	1317	77.1	1366	62.6
1220	93.7	1269	94.4	1318	77.1	1367	62.7
1221	93.9	1270	94.3	1319	77.2	1368	61.9
1222	94.0	1271	94.3	1320	77.2	1369	60.0
1223	94.1	1272	94.1	1321	77.6	1370	58.4
1224	94.3	1273	93.9	1322	78.0	1371	57.8
1225	94.4	1274	93.4	1323	78.4	1372	57.8
1226	94.6	1275	92.8	1324	78.8	1373	57.8
1227	94.7	1276	92.0	1325	79.2	1374	57.3
1228	94.8	1277	91.3	1326	80.3	1375	56.2
1229	95.0	1278	90.6	1327	80.8	1376	54.3
1230	95.1	1279	90.0	1328	81.0	1377	50.8
1231	95.3	1280	89.3	1329	81.0	1378	45.5
1232	95.4	1281	88.7	1330	81.0	1379	40.2
1233	95.6	1282	88.1	1331	81.0	1380	34.9
1234	95.7	1283	87.4	1332	81.0	1381	29.6
1235	95.8	1284	86.7	1333	80.9	1382	28.7
1236	96.0	1285	86.0	1334	80.6	1383	29.3
1237	96.1	1286	85.3	1335	80.3	1384	30.5
1238	96.3	1287	84.7	1336	80.0	1385	31.7
1239	96.4	1288	84.1	1337	79.9	1386	32.9
1240	96.6	1289	83.5	1338	79.8	1387	35.0
1241	96.8	1290	82.9	1339	79.8	1388	38.0
1242	97.0	1291	82.3	1340	79.8	1389	40.5
1243	97.2	1292	81.7	1341	79.9	1390	42.7
1244	97.3	1293	81.1	1342	80.0	1391	45.8
1245	97.4	1294	80.5	1343	80.4	1392	47.5
1246	97.4	1295	79.9	1344	80.8	1393	48.9
1247	97.4	1296	79.4	1345	81.2	1394	49.4
1248	97.4	1297	79.1	1346	81.5	1395	49.4
1249	97.3	1298	78.8	1347	81.6	1396	49.2
1250	97.3	1299	78.5	1348	81.6	1397	48.7
1251	97.3	1300	78.2	1349	81.4	1398	47.9
1252	97.3	1301	77.9	1350	80.7	1399	46.9
1253	97.2	1302	77.6	1351	79.6	1400	45.6
1254	97.1	1303	77.3	1352	78.2	1401	44.2
1255	97.0	1304	77.0	1353	76.8	1402	42.7
1256	96.9	1305	76.7	1354	75.3	1403	40.7
1257	96.7	1306	76.0	1355	73.8	1404	37.1
1258	96.4	1307	76.0	1356	72.1	1405	33.9
1259	96.1	1308	76.0	1357	70.2	1406	30.6

<i>Time in s</i>	<i>Speed in km/h</i>	<i>Time in s</i>	<i>Speed in km/h</i>	<i>Time in s</i>	<i>Speed in km/h</i>	<i>Time in s</i>	<i>Speed in km/h</i>
1407	28.6	1456	0.0				
1408	27.3	1457	0.0				
1409	27.2	1458	0.0				
1410	27.5	1459	0.0				
1411	27.4	1460	0.0				
1412	27.1	1461	0.0				
1413	26.7	1462	0.0				
1414	26.8	1463	0.0				
1415	28.2	1464	0.0				
1416	31.1	1465	0.0				
1417	34.8	1466	0.0				
1418	38.4	1467	0.0				
1419	40.9	1468	0.0				
1420	41.7	1469	0.0				
1421	40.9	1470	0.0				
1422	38.3	1471	0.0				
1423	35.3	1472	0.0				
1424	34.3	1473	0.0				
1425	34.6	1474	0.0				
1426	36.3	1475	0.0				
1427	39.5	1476	0.0				
1428	41.8	1477	0.0				
1429	42.5						
1430	41.9						
1431	40.1						
1432	36.6						
1433	31.3						
1434	26.0						
1435	20.6						
1436	19.1						
1437	19.7						
1438	21.1						
1439	22.0						
1440	22.1						
1441	21.4						
1442	19.6						
1443	18.3						
1444	18.0						
1445	18.3						
1446	18.5						
1447	17.9						
1448	15.0						
1449	9.9						
1450	4.6						
1451	1.2						
1452	0.0						
1453	0.0						
1454	0.0						
1455	0.0						

Table A1/11
WLTC, Class 3b cycle, phase High_{3b} (Second 1022 is the start of this phase)

<i>Time in s</i>	<i>Speed in km/h</i>	<i>Time in s</i>	<i>Speed in km/h</i>	<i>Time in s</i>	<i>Speed in km/h</i>	<i>Time in s</i>	<i>Speed in km/h</i>
1023	0.0	1070	26.4	1117	69.7	1164	52.6
1024	0.0	1071	28.8	1118	69.3	1165	54.5
1025	0.0	1072	31.8	1119	68.1	1166	56.6
1026	0.0	1073	35.3	1120	66.9	1167	58.3
1027	0.8	1074	39.5	1121	66.2	1168	60.0
1028	3.6	1075	44.5	1122	65.7	1169	61.5
1029	8.6	1076	49.3	1123	64.9	1170	63.1
1030	14.6	1077	53.3	1124	63.2	1171	64.3
1031	20.0	1078	56.4	1125	60.3	1172	65.7
1032	24.4	1079	58.9	1126	55.8	1173	67.1
1033	28.2	1080	61.2	1127	50.5	1174	68.3
1034	31.7	1081	62.6	1128	45.2	1175	69.7
1035	35.0	1082	63.0	1129	40.1	1176	70.6
1036	37.6	1083	62.5	1130	36.2	1177	71.6
1037	39.7	1084	60.9	1131	32.9	1178	72.6
1038	41.5	1085	59.3	1132	29.8	1179	73.5
1039	43.6	1086	58.6	1133	26.6	1180	74.2
1040	46.0	1087	58.6	1134	23.0	1181	74.9
1041	48.4	1088	58.7	1135	19.4	1182	75.6
1042	50.5	1089	58.8	1136	16.3	1183	76.3
1043	51.9	1090	58.8	1137	14.6	1184	77.1
1044	52.6	1091	58.8	1138	14.2	1185	77.9
1045	52.8	1092	59.1	1139	14.3	1186	78.5
1046	52.9	1093	60.1	1140	14.6	1187	79.0
1047	53.1	1094	61.7	1141	15.1	1188	79.7
1048	53.3	1095	63.0	1142	16.4	1189	80.3
1049	53.1	1096	63.7	1143	19.1	1190	81.0
1050	52.3	1097	63.9	1144	22.5	1191	81.6
1051	50.7	1098	63.5	1145	24.4	1192	82.4
1052	48.8	1099	62.3	1146	24.8	1193	82.9
1053	46.5	1100	60.3	1147	22.7	1194	83.4
1054	43.8	1101	58.9	1148	17.4	1195	83.8
1055	40.3	1102	58.4	1149	13.8	1196	84.2
1056	36.0	1103	58.8	1150	12.0	1197	84.7
1057	30.7	1104	60.2	1151	12.0	1198	85.2
1058	25.4	1105	62.3	1152	12.0	1199	85.6
1059	21.0	1106	63.9	1153	13.9	1200	86.3
1060	16.7	1107	64.5	1154	17.7	1201	86.8
1061	13.4	1108	64.4	1155	22.8	1202	87.4
1062	12.0	1109	63.5	1156	27.3	1203	88.0
1063	12.1	1110	62.0	1157	31.2	1204	88.3
1064	12.8	1111	61.2	1158	35.2	1205	88.7
1065	15.6	1112	61.3	1159	39.4	1206	89.0
1066	19.9	1113	62.6	1160	42.5	1207	89.3
1067	23.4	1114	65.3	1161	45.4	1208	89.8
1068	24.6	1115	68.0	1162	48.2	1209	90.2
1069	25.2	1116	69.4	1163	50.3	1210	90.6

<i>Time in s</i>	<i>Speed in km/h</i>	<i>Time in s</i>	<i>Speed in km/h</i>	<i>Time in s</i>	<i>Speed in km/h</i>	<i>Time in s</i>	<i>Speed in km/h</i>
1211	91.0	1260	95.7	1309	75.9	1358	68.2
1212	91.3	1261	95.5	1310	75.9	1359	66.1
1213	91.6	1262	95.3	1311	75.8	1360	63.8
1214	91.9	1263	95.2	1312	75.7	1361	61.6
1215	92.2	1264	95.0	1313	75.5	1362	60.2
1216	92.8	1265	94.9	1314	75.2	1363	59.8
1217	93.1	1266	94.7	1315	75.0	1364	60.4
1218	93.3	1267	94.5	1316	74.7	1365	61.8
1219	93.5	1268	94.4	1317	74.1	1366	62.6
1220	93.7	1269	94.4	1318	73.7	1367	62.7
1221	93.9	1270	94.3	1319	73.3	1368	61.9
1222	94.0	1271	94.3	1320	73.5	1369	60.0
1223	94.1	1272	94.1	1321	74.0	1370	58.4
1224	94.3	1273	93.9	1322	74.9	1371	57.8
1225	94.4	1274	93.4	1323	76.1	1372	57.8
1226	94.6	1275	92.8	1324	77.7	1373	57.8
1227	94.7	1276	92.0	1325	79.2	1374	57.3
1228	94.8	1277	91.3	1326	80.3	1375	56.2
1229	95.0	1278	90.6	1327	80.8	1376	54.3
1230	95.1	1279	90.0	1328	81.0	1377	50.8
1231	95.3	1280	89.3	1329	81.0	1378	45.5
1232	95.4	1281	88.7	1330	81.0	1379	40.2
1233	95.6	1282	88.1	1331	81.0	1380	34.9
1234	95.7	1283	87.4	1332	81.0	1381	29.6
1235	95.8	1284	86.7	1333	80.9	1382	27.3
1236	96.0	1285	86.0	1334	80.6	1383	29.3
1237	96.1	1286	85.3	1335	80.3	1384	32.9
1238	96.3	1287	84.7	1336	80.0	1385	35.6
1239	96.4	1288	84.1	1337	79.9	1386	36.7
1240	96.6	1289	83.5	1338	79.8	1387	37.6
1241	96.8	1290	82.9	1339	79.8	1388	39.4
1242	97.0	1291	82.3	1340	79.8	1389	42.5
1243	97.2	1292	81.7	1341	79.9	1390	46.5
1244	97.3	1293	81.1	1342	80.0	1391	50.2
1245	97.4	1294	80.5	1343	80.4	1392	52.8
1246	97.4	1295	79.9	1344	80.8	1393	54.3
1247	97.4	1296	79.4	1345	81.2	1394	54.9
1248	97.4	1297	79.1	1346	81.5	1395	54.9
1249	97.3	1298	78.8	1347	81.6	1396	54.7
1250	97.3	1299	78.5	1348	81.6	1397	54.1
1251	97.3	1300	78.2	1349	81.4	1398	53.2
1252	97.3	1301	77.9	1350	80.7	1399	52.1
1253	97.2	1302	77.6	1351	79.6	1400	50.7
1254	97.1	1303	77.3	1352	78.2	1401	49.1
1255	97.0	1304	77.0	1353	76.8	1402	47.4
1256	96.9	1305	76.7	1354	75.3	1403	45.2
1257	96.7	1306	76.0	1355	73.8	1404	41.8
1258	96.4	1307	76.0	1356	72.1	1405	36.5
1259	96.1	1308	76.0	1357	70.2	1406	31.2

<i>Time in s</i>	<i>Speed in km/h</i>	<i>Time in s</i>	<i>Speed in km/h</i>	<i>Time in s</i>	<i>Speed in km/h</i>	<i>Time in s</i>	<i>Speed in km/h</i>
1407	27.6	1456	0.0				
1408	26.9	1457	0.0				
1409	27.3	1458	0.0				
1410	27.5	1459	0.0				
1411	27.4	1460	0.0				
1412	27.1	1461	0.0				
1413	26.7	1462	0.0				
1414	26.8	1463	0.0				
1415	28.2	1464	0.0				
1416	31.1	1465	0.0				
1417	34.8	1466	0.0				
1418	38.4	1467	0.0				
1419	40.9	1468	0.0				
1420	41.7	1469	0.0				
1421	40.9	1470	0.0				
1422	38.3	1471	0.0				
1423	35.3	1472	0.0				
1424	34.3	1473	0.0				
1425	34.6	1474	0.0				
1426	36.3	1475	0.0				
1427	39.5	1476	0.0				
1428	41.8	1477	0.0				
1429	42.5						
1430	41.9						
1431	40.1						
1432	36.6						
1433	31.3						
1434	26.0						
1435	20.6						
1436	19.1						
1437	19.7						
1438	21.1						
1439	22.0						
1440	22.1						
1441	21.4						
1442	19.6						
1443	18.3						
1444	18.0						
1445	18.3						
1446	18.5						
1447	17.9						
1448	15.0						
1449	9.9						
1450	4.6						
1451	1.2						
1452	0.0						
1453	0.0						
1454	0.0						
1455	0.0						

Table A1/12
WLTC, Class 3 cycle, phase Extra High₃ (Second 1477 is the start of this phase)

<i>Time in s</i>	<i>Speed in km/h</i>	<i>Time in s</i>	<i>Speed in km/h</i>	<i>Time in s</i>	<i>Speed in km/h</i>	<i>Time in s</i>	<i>Speed in km/h</i>
1478	0.0	1525	72.5	1572	120.7	1619	113.0
1479	2.2	1526	70.8	1573	121.8	1620	114.1
1480	4.4	1527	68.6	1574	122.6	1621	115.1
1481	6.3	1528	66.2	1575	123.2	1622	115.9
1482	7.9	1529	64.0	1576	123.6	1623	116.5
1483	9.2	1530	62.2	1577	123.7	1624	116.7
1484	10.4	1531	60.9	1578	123.6	1625	116.6
1485	11.5	1532	60.2	1579	123.3	1626	116.2
1486	12.9	1533	60.0	1580	123.0	1627	115.2
1487	14.7	1534	60.4	1581	122.5	1628	113.8
1488	17.0	1535	61.4	1582	122.1	1629	112.0
1489	19.8	1536	63.2	1583	121.5	1630	110.1
1490	23.1	1537	65.6	1584	120.8	1631	108.3
1491	26.7	1538	68.4	1585	120.0	1632	107.0
1492	30.5	1539	71.6	1586	119.1	1633	106.1
1493	34.1	1540	74.9	1587	118.1	1634	105.8
1494	37.5	1541	78.4	1588	117.1	1635	105.7
1495	40.6	1542	81.8	1589	116.2	1636	105.7
1496	43.3	1543	84.9	1590	115.5	1637	105.6
1497	45.7	1544	87.4	1591	114.9	1638	105.3
1498	47.7	1545	89.0	1592	114.5	1639	104.9
1499	49.3	1546	90.0	1593	114.1	1640	104.4
1500	50.5	1547	90.6	1594	113.9	1641	104.0
1501	51.3	1548	91.0	1595	113.7	1642	103.8
1502	52.1	1549	91.5	1596	113.3	1643	103.9
1503	52.7	1550	92.0	1597	112.9	1644	104.4
1504	53.4	1551	92.7	1598	112.2	1645	105.1
1505	54.0	1552	93.4	1599	111.4	1646	106.1
1506	54.5	1553	94.2	1600	110.5	1647	107.2
1507	55.0	1554	94.9	1601	109.5	1648	108.5
1508	55.6	1555	95.7	1602	108.5	1649	109.9
1509	56.3	1556	96.6	1603	107.7	1650	111.3
1510	57.2	1557	97.7	1604	107.1	1651	112.7
1511	58.5	1558	98.9	1605	106.6	1652	113.9
1512	60.2	1559	100.4	1606	106.4	1653	115.0
1513	62.3	1560	102.0	1607	106.2	1654	116.0
1514	64.7	1561	103.6	1608	106.2	1655	116.8
1515	67.1	1562	105.2	1609	106.2	1656	117.6
1516	69.2	1563	106.8	1610	106.4	1657	118.4
1517	70.7	1564	108.5	1611	106.5	1658	119.2
1518	71.9	1565	110.2	1612	106.8	1659	120.0
1519	72.7	1566	111.9	1613	107.2	1660	120.8
1520	73.4	1567	113.7	1614	107.8	1661	121.6
1521	73.8	1568	115.3	1615	108.5	1662	122.3
1522	74.1	1569	116.8	1616	109.4	1663	123.1
1523	74.0	1570	118.2	1617	110.5	1664	123.8
1524	73.6	1571	119.5	1618	111.7	1665	124.4

<i>Time in s</i>	<i>Speed in km/h</i>	<i>Time in s</i>	<i>Speed in km/h</i>	<i>Time in s</i>	<i>Speed in km/h</i>	<i>Time in s</i>	<i>Speed in km/h</i>
1666	125.0	1715	127.7	1764	82.0		
1667	125.4	1716	128.1	1765	81.3		
1668	125.8	1717	128.5	1766	80.4		
1669	126.1	1718	129.0	1767	79.1		
1670	126.4	1719	129.5	1768	77.4		
1671	126.6	1720	130.1	1769	75.1		
1672	126.7	1721	130.6	1770	72.3		
1673	126.8	1722	131.0	1771	69.1		
1674	126.9	1723	131.2	1772	65.9		
1675	126.9	1724	131.3	1773	62.7		
1676	126.9	1725	131.2	1774	59.7		
1677	126.8	1726	130.7	1775	57.0		
1678	126.6	1727	129.8	1776	54.6		
1679	126.3	1728	128.4	1777	52.2		
1680	126.0	1729	126.5	1778	49.7		
1681	125.7	1730	124.1	1779	46.8		
1682	125.6	1731	121.6	1780	43.5		
1683	125.6	1732	119.0	1781	39.9		
1684	125.8	1733	116.5	1782	36.4		
1685	126.2	1734	114.1	1783	33.2		
1686	126.6	1735	111.8	1784	30.5		
1687	127.0	1736	109.5	1785	28.3		
1688	127.4	1737	107.1	1786	26.3		
1689	127.6	1738	104.8	1787	24.4		
1690	127.8	1739	102.5	1788	22.5		
1691	127.9	1740	100.4	1789	20.5		
1692	128.0	1741	98.6	1790	18.2		
1693	128.1	1742	97.2	1791	15.5		
1694	128.2	1743	95.9	1792	12.3		
1695	128.3	1744	94.8	1793	8.7		
1696	128.4	1745	93.8	1794	5.2		
1697	128.5	1746	92.8	1795	0.0		
1698	128.6	1747	91.8	1796	0.0		
1699	128.6	1748	91.0	1797	0.0		
1700	128.5	1749	90.2	1798	0.0		
1701	128.3	1750	89.6	1799	0.0		
1702	128.1	1751	89.1	1800	0.0		
1703	127.9	1752	88.6				
1704	127.6	1753	88.1				
1705	127.4	1754	87.6				
1706	127.2	1755	87.1				
1707	127.0	1756	86.6				
1708	126.9	1757	86.1				
1709	126.8	1758	85.5				
1710	126.7	1759	85.0				
1711	126.8	1760	84.4				
1712	126.9	1761	83.8				
1713	127.1	1762	83.2				
1714	127.4	1763	82.6				

7. Cycle identification

In order to confirm if the correct cycle version was chosen or if the correct cycle was implemented into the test bench operation system, checksums of the vehicle speed values for cycle phases and the whole cycle are listed in Table A1/13.

Table A1/13

1Hz checksums (as applicable)

<i>Cycle class</i>	<i>Cycle phase</i>	<i>Checksum of 1 Hz target vehicle speeds</i>
Class 1	Low	11988.4
	Medium	17162.8
	Low	11988.4
	Total	41139.6
Class 2	Low	11162.2
	Medium	17054.3
	High	24450.6
	Extra High	28869.8
	Total	81536.9
Class 3a	Low	11140.3
	Medium	16995.7
	High	25646.0
	Extra High	29714.9
	Total	83496.9
Class 3b	Low	11140.3
	Medium	17121.2
	High	25782.2
	Extra High	29714.9
	Total	83758.6

8. Cycle modification

This paragraph shall not apply to OVC-HEVs, NOVC-HEVs and NOVC-FCHVs.

8.1. General remarks

Driveability problems may occur for vehicles with power to mass ratios close to the borderlines between Class 1 and Class 2, Class 2 and Class 3 vehicles, or very low powered vehicles in Class 1.

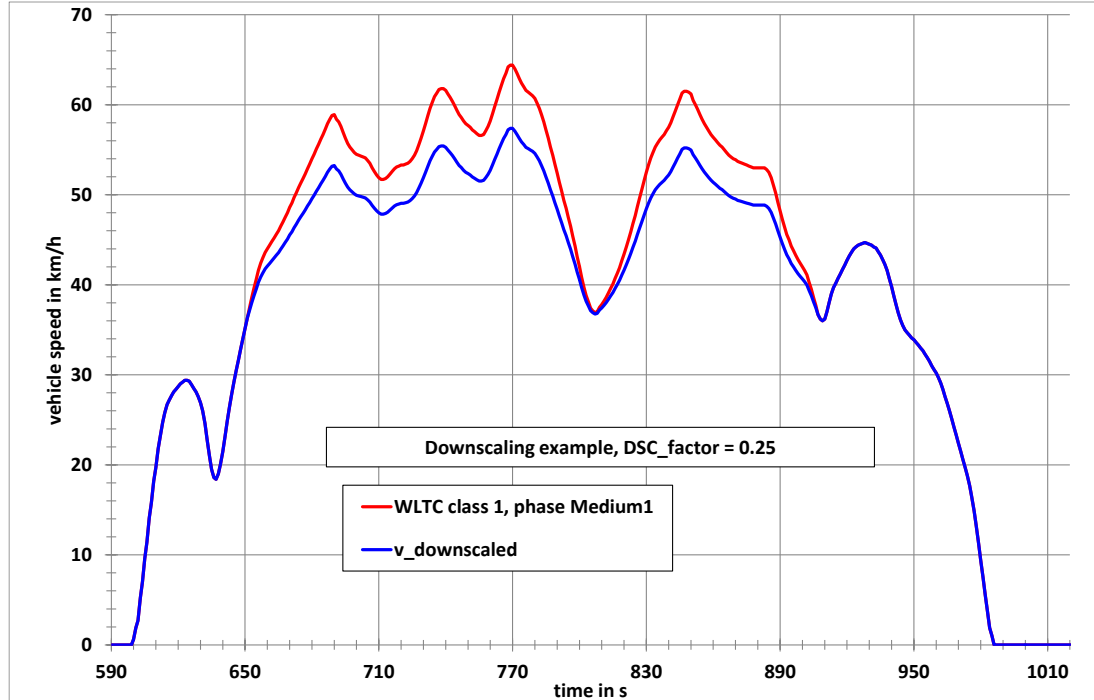
Since these problems are related mainly to cycle phases with a combination of high vehicle speed and high accelerations rather than to the maximum speed of the cycle, the downscaling procedure shall be applied to improve driveability.

8.2. This paragraph describes the method to modify the cycle profile using the downscaling procedure. The modified vehicle speed values calculated according to paragraphs 8.2.1 to 8.2.3. shall be rounded according to paragraph 6.1.8. of this Regulation to 1 place of decimal in a final step.

8.2.1. Downscaling procedure for Class 1 cycles

Figure A1/14 shows an example of a downscaled medium speed phase of the Class 1 WLTC.

Figure A1/14

Downscaled medium speed phase of the Class 1 WLTC

For the Class 1 cycle, the downscaling period is the time period between second 651 and second 906. Within this time period, the acceleration for the original cycle shall be calculated using the following equation:

$$a_{\text{orig}_i} = \frac{v_{i+1} - v_i}{3.6}$$

where:

v_i is the vehicle speed, km/h;

i is the time between second 651 and second 906.

The downscaling shall be applied first in the time period between second 651 and second 848. The downscaled speed trace shall be subsequently calculated using the following equation:

$$v_{\text{dsc}_{i+1}} = v_{\text{dsc}_i} + a_{\text{orig}_i} \times (1 - f_{\text{dsc}}) \times 3.6$$

with $i = 651$ to 847.

For $i = 651$, $v_{\text{dsc}_i} = v_{\text{orig}_i}$.

In order to meet the original vehicle speed at second 907, a correction factor for the deceleration shall be calculated using the following equation:

$$f_{\text{corr_dec}} = \frac{v_{\text{dsc}_{848}} - 36.7}{v_{\text{orig}_{848}} - 36.7}$$

where 36.7 km/h is the original vehicle speed at second 907.

The downscaled vehicle speed between second 849 and second 906 shall be subsequently calculated using the following equation:

$$v_{\text{dsc}_i} = v_{\text{dsc}_{i-1}} + a_{\text{orig}_{i-1}} \times f_{\text{corr_dec}} \times 3.6$$

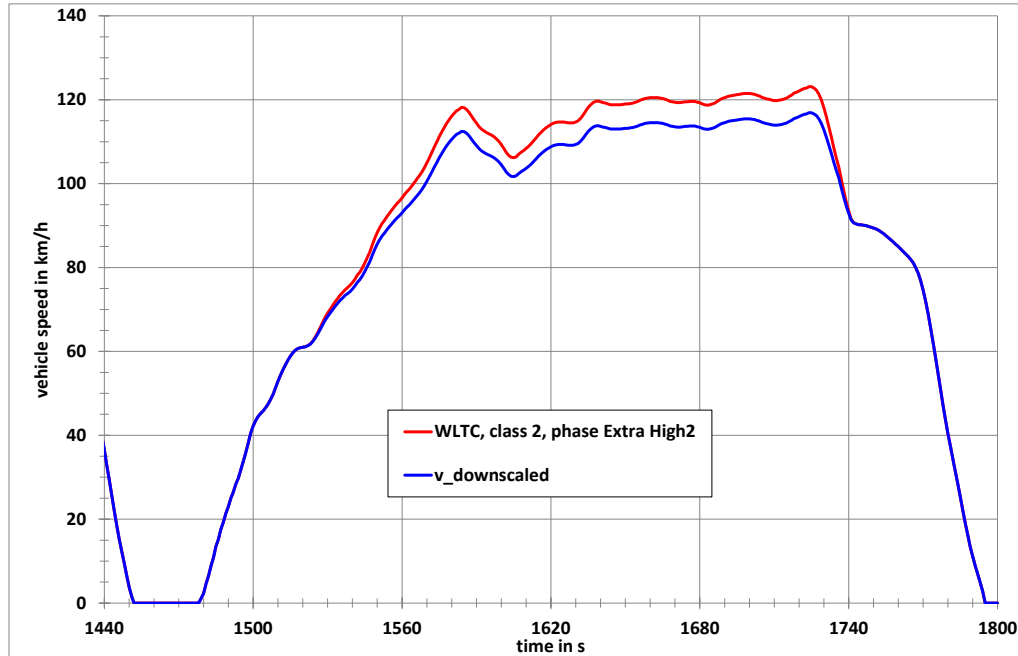
For $i = 849$ to 906.

8.2.2. Downscaling procedure for Class 2 cycles

Since the driveability problems are exclusively related to the extra high speed phases of the Class 2 and Class 3 cycles, the downscaling is related to those time periods of the extra high speed phases where driveability problems are expected to occur (see Figures A1/15 and A1/16).

Figure A1/15

Downscaled extra high speed phase of the Class 2 WLTC



For the Class 2 cycle, the downscaling period is the time period between second 1520 and second 1742. Within this time period, the acceleration for the original cycle shall be calculated using the following equation:

$$a_{orig_i} = \frac{v_{i+1} - v_i}{3.6}$$

where:

v_i is the vehicle speed, km/h;

i is the time between second 1520 and second 1742.

The downscaling shall be applied first to the time period between second 1520 and second 1725. Second 1725 is the time when the maximum speed of the extra high speed phase is reached. The downscaled speed trace shall be subsequently calculated using the following equation:

$$v_{dsc_{i+1}} = v_{dsc_i} + a_{orig_i} \times (1 - f_{dsc}) \times 3.6$$

for $i = 1520$ to 1724 .

For $i = 1520$, $v_{dsc_i} = v_{orig_i}$.

In order to meet the original vehicle speed at second 1743, a correction factor for the deceleration shall be calculated using the following equation:

$$f_{corr_dec} = \frac{v_{dsc_1725} - 90.4}{v_{orig_1725} - 90.4}$$

90.4 km/h is the original vehicle speed at second 1743.

The downscaled vehicle speed between second 1726 and second 1742 shall be calculated using the following equation:

$$v_{dsc_i} = v_{dsc_{i-1}} + a_{orig_{i-1}} \times f_{corr_dec} \times 3.6$$

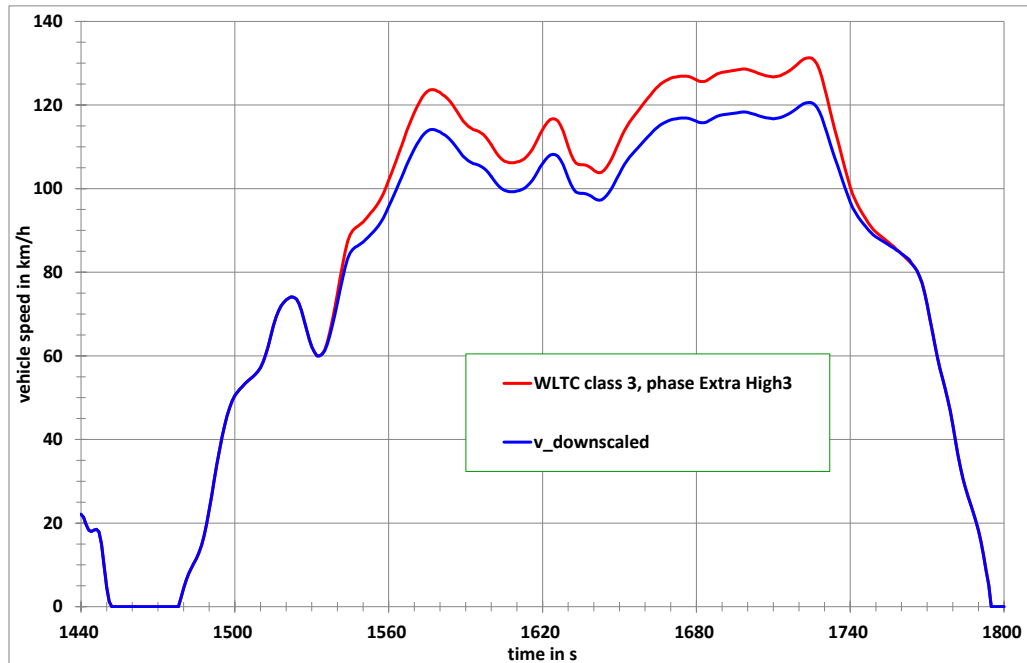
for $i = 1726$ to 1742 .

8.2.3. Downscaling procedure for Class 3 cycles

Figure A1/16 shows an example for a downscaled extra high speed phase of the Class 3 WLTC.

Figure A1/16

Downscaled extra high speed phase of the Class 3 WLTC



For the Class 3 cycle, the downscaling period is the time period between second 1533 and second 1762. Within this time period, the acceleration for the original cycle shall be calculated using the following equation:

$$a_{orig_i} = \frac{v_{i+1} - v_i}{3.6}$$

where:

v_i is the vehicle speed, km/h;

i is the time between second 1533 and second 1762.

The downscaling shall be applied first in the time period between second 1533 and second 1724. Second 1724 is the time when the maximum speed of the extra high speed phase is reached. The downscaled speed trace shall be subsequently calculated using the following equation:

$$v_{dsc_{i+1}} = v_{dsc_i} + a_{orig_i} \times (1 - f_{dsc}) \times 3.6$$

For $i = 1533$ to 1723 .

For $i = 1533$, $v_{dsc_i} = v_{orig_i}$.

In order to meet the original vehicle speed at second 1763, a correction factor for the deceleration shall be calculated using the following equation:

$$f_{corr_dec} = \frac{v_{dsc_1724} - 82.6}{v_{orig_1724} - 82.6}$$

82.6 km/h is the original vehicle speed at second 1763.

The downscaled vehicle speed between second 1725 and second 1762 shall be subsequently calculated using the following equation:

$$v_{dsc_i} = v_{dsc_{i-1}} + a_{orig_{i-1}} \times f_{corr_dec} \times 3.6$$

For $i = 1725$ to 1762 .

8.3. Determination of the downscaling factor (as applicable)

The downscaling factor f_{dsc} is a function of the ratio r_{max} between the maximum required power of the cycle phases where the downscaling is to be applied and the rated power of the vehicle, P_{rated} .

The maximum required power $P_{req,max,i}$ (in kW) is related to a specific time i and the corresponding vehicle speed v_i in the cycle trace and is calculated using the following equation:

$$P_{req,max,i} = \frac{\left((f_0 \times v_i) + (f_1 \times v_i^2) + (f_2 \times v_i^3) + (1.03 \times TM \times v_i \times a_i) \right)}{3600}$$

where:

f_0, f_1, f_2 are the applicable road load coefficients, N, N/(km/h), and N/(km/h)² respectively;

TM is the applicable test mass, kg;

v_i is the speed at time i , km/h;

a_i is the acceleration at time i , m/s².

The cycle time i at which maximum power or power values close to maximum power is required is second 764 for the Class 1 cycle, second 1574 for the Class 2 cycle and second 1566 for the Class 3 cycle.

The corresponding vehicle speed values, v_i , and acceleration values, a_i , are as follows:

$v_i = 61.4$ km/h, $a_i = 0.22$ m/s² for Class 1,

$v_i = 109.9$ km/h, $a_i = 0.36$ m/s² for Class 2,

$v_i = 111.9$ km/h, $a_i = 0.50$ m/s² for Class 3.

r_{max} shall be calculated using the following equation:

$$r_{max} = \frac{P_{req,max,i}}{P_{rated}}$$

The downscaling factor, f_{dsc} , shall be calculated using the following equations:

$$\text{if } r_{max} < r_0, \text{ then } f_{dsc} = 0$$

and no downscaling shall be applied.

If $r_{max} \geq r_0$, then $f_{dsc} = a_1 \times r_{max} + b_1$.

The calculation parameter/coefficients, r_0 , a_1 and b_1 , are as follows:

Class 1 $r_0 = 0.978, a_1 = 0.680, b_1 = -0.665$

Class 2 $r_0 = 0.866, a_1 = 0.606, b_1 = -0.525$.

Class 3 $r_0 = 0.867, a_1 = 0.588, b_1 = -0.510$.

The resulting f_{dsc} shall be rounded according to paragraph 6.1.8. of this Regulation to 3 places of decimal and shall be applied only if it exceeds 0.010.

The following data shall be recorded:

- (a) f_{dsc} ;
- (b) v_{max} ;
- (c) d_{cycle} (distance driven), m.

The distance shall be calculated using the following equation:

$$d_{cycle} = \sum \left(\frac{(v_i + v_{i-1})}{2 \times 3.6} \times (t_i - t_{i-1}) \right), \text{ for}$$

$i = t_{\text{start}} + 1$ to t_{end}

t_{start} is the time at which the applicable test cycle starts (see paragraph 3 of this annex), s;

t_{end} is the time at which the applicable test cycle ends (see paragraph 3 of this annex), s.

8.4. Additional requirements (as applicable)

For different vehicle configurations in terms of test mass and driving resistance coefficients, downscaling shall be applied individually.

If, after application of downscaling, the vehicle's maximum speed is lower than the maximum speed of the cycle, the process described in paragraph 9. of this annex shall be applied with the applicable cycle.

If the vehicle cannot follow the speed trace of the applicable cycle within the tolerance at speeds lower than its maximum speed, it shall be driven with the accelerator control fully activated during these periods. During such periods of operation, speed trace violations shall be permitted.

9. Cycle modifications for vehicles with a maximum speed lower than the maximum speed of the cycle specified in the previous paragraphs of this annex

9.1. General remarks

This paragraph applies to vehicles that are technically able to follow the speed trace of the applicable cycle specified in paragraph 1. of this annex (base cycle) at speeds lower than its maximum speed, but whose maximum speed is limited to a value lower than the maximum speed of the base cycle for other reasons. For the purposes of this paragraph, the applicable cycle specified in paragraph 1. shall be referred to as the "base cycle" and is used to determine the capped speed cycle.

In the cases where downscaling according to paragraph 8.2. of this annex is applied, the downscaled cycle shall be used as the base cycle.

The maximum speed of the base cycle shall be referred to as $v_{\text{max,cycle}}$.

The maximum speed of the vehicle shall be referred to as its capped speed v_{cap} .

If v_{cap} is applied to a Class 3b vehicle, the Class 3b cycle as defined in paragraph 3.3.2. of this annex shall be used as the base cycle. This shall apply even if v_{cap} is lower than 120 km/h.

In the cases where v_{cap} is applied, the base cycle shall be modified as described in paragraph 9.2. of this annex in order to achieve the same cycle distance for the capped speed cycle as for the base cycle.

9.2. Calculation steps

9.2.1. Determination of the distance difference per cycle phase

An interim capped speed cycle shall be derived by replacing all vehicle speed samples v_i where $v_i > v_{\text{cap}}$ by v_{cap} .

9.2.1.1. If $v_{\text{cap}} < v_{\text{max,medium}}$, the distance of the medium speed phases of the base cycle $d_{\text{base,medium}}$ and the interim capped speed cycle $d_{\text{cap,medium}}$ shall be calculated using the following equation for both cycles:

$$d_{\text{medium}} = \sum \left(\frac{(v_i + v_{i-1})}{2 \times 3.6} \times (t_i - t_{i-1}) \right), \text{ for } i = 590 \text{ to } 1022$$

where:

$v_{\text{max,medium}}$ is the maximum vehicle speed of the medium speed phase as listed in Table A1/2 for the Class 1 cycle, in Table A1/4 for the Class 2 cycle, in Table A1/8 for the Class 3a cycle and in Table A1/9 for the Class 3b cycle.

- 9.2.1.2. If $v_{cap} < v_{max,high}$, the distances of the high speed phases of the base cycle $d_{base,high}$ and the interim capped speed cycle $d_{cap,high}$ shall be calculated using the following equation for both cycles:

$$d_{high} = \sum \left(\frac{(v_i + v_{i-1})}{2 \times 3.6} \times (t_i - t_{i-1}) \right), \text{ for } i = 1023 \text{ to } 1477$$

$v_{max,high}$ is the maximum vehicle speed of the high speed phase as listed in Table A1/5 for the Class 2 cycle, in Table A1/10 for the Class 3a cycle and in Table A1/11 for the Class 3b cycle.

- 9.2.1.3. The distances of the extra high speed phase of the base cycle $d_{base,exhigh}$ and the interim capped speed cycle $d_{cap,exhigh}$ shall be calculated applying the following equation to the extra high speed phase of both cycles:

$$d_{exhigh} = \sum \left(\frac{(v_i + v_{i-1})}{2 \times 3.6} \times (t_i - t_{i-1}) \right), \text{ for } i = 1478 \text{ to } 1800$$

- 9.2.2. Determination of the time periods to be added to the interim capped speed cycle in order to compensate for distance differences

In order to compensate for a difference in distance between the base cycle and the interim capped speed cycle, corresponding time periods with $v_i = v_{cap}$ shall be added to the interim capped speed cycle as described in paragraphs 9.2.2.1. to 9.2.2.3. inclusive of this annex.

- 9.2.2.1. Additional time period for the medium speed phase

If $v_{cap} < v_{max,medium}$, the additional time period to be added to the medium speed phase of the interim capped speed cycle shall be calculated using the following equation:

$$\Delta t_{medium} = \frac{(d_{base,medium} - d_{cap,medium})}{v_{cap}} \times 3.6$$

The number of time samples $n_{add,medium}$ with $v_i = v_{cap}$ to be added to the medium speed phase of the interim capped speed cycle equals Δt_{medium} , rounded according to paragraph 6.1.8. of this Regulation to the nearest integer.

- 9.2.2.2. Additional time period for the high speed phase

If $v_{cap} < v_{max,high}$, the additional time period to be added to the high speed phases of the interim capped speed cycle shall be calculated using the following equation:

$$\Delta t_{high} = \frac{(d_{base,high} - d_{cap,high})}{v_{cap}} \times 3.6$$

The number of time samples $n_{add,high}$ with $v_i = v_{cap}$ to be added to the high speed phase of the interim capped speed cycle equals Δt_{high} , rounded according to paragraph 6.1.8. of this Regulation to the nearest integer.

- 9.2.2.3. The additional time period to be added to the extra high speed phase of the interim capped speed cycle shall be calculated using the following equation:

$$\Delta t_{exhigh} = \frac{(d_{base,exhigh} - d_{cap,exhigh})}{v_{cap}} \times 3.6$$

The number of time samples $n_{add,exhigh}$ with $v_i = v_{cap}$ to be added to the extra high speed phase of the interim capped speed cycle equals Δt_{exhigh} , rounded according to paragraph 6.1.8. of this Regulation to the nearest integer.

- 9.2.3. Construction of the final capped speed cycle

- 9.2.3.1. Class 1 cycle

The first part of the final capped speed cycle consists of the vehicle speed trace of the interim capped speed cycle up to the last sample in the medium speed phase where $v = v_{cap}$. The time of this sample is referred to as t_{medium} .

Then $n_{\text{add,medium}}$ samples with $v_i = v_{\text{cap}}$ shall be added, so that the time of the last sample is $(t_{\text{medium}} + n_{\text{add,medium}})$.

The remaining part of the medium speed phase of the interim capped speed cycle, which is identical with the same part of the base cycle, shall then be added, so that the time of the last sample is $(1022 + n_{\text{add,medium}})$.

9.2.3.2. Class 2 and Class 3 cycles

9.2.3.2.1. $v_{\text{cap}} < v_{\text{max,medium}}$

The first part of the final capped speed cycle consists of the vehicle speed trace of the interim capped speed cycle up to the last sample in the medium speed phase where $v = v_{\text{cap}}$. The time of this sample is referred to as t_{medium} .

Then $n_{\text{add,medium}}$ samples with $v_i = v_{\text{cap}}$ shall be added, so that the time of the last sample is $(t_{\text{medium}} + n_{\text{add,medium}})$.

The remaining part of the medium speed phase of the interim capped speed cycle, which is identical with the same part of the base cycle, shall then be added, so that the time of the last sample is $(1022 + n_{\text{add,medium}})$.

In a next step, the first part of the high speed phase of the interim capped speed cycle up to the last sample in the high speed phase where $v = v_{\text{cap}}$ shall be added. The time of this sample in the interim capped speed is referred to as t_{high} , so that the time of this sample in the final capped speed cycle is $(t_{\text{high}} + n_{\text{add,medium}})$.

Then, $n_{\text{add,high}}$ samples with $v_i = v_{\text{cap}}$ shall be added, so that the time of the last sample becomes $(t_{\text{high}} + n_{\text{add,medium}} + n_{\text{add,high}})$.

The remaining part of the high speed phase of the interim capped speed cycle, which is identical with the same part of the base cycle, shall then be added, so that the time of the last sample is $(1477 + n_{\text{add,medium}} + n_{\text{add,high}})$.

In a next step, the first part of the extra high speed phase (if applicable) of the interim capped speed cycle up to the last sample in the extra high speed phase where $v = v_{\text{cap}}$ shall be added. The time of this sample in the interim capped speed is referred to as t_{exhigh} , so that the time of this sample in the final capped speed cycle is $(t_{\text{exhigh}} + n_{\text{add,medium}} + n_{\text{add,high}})$.

Then $n_{\text{add,exhigh}}$ samples with $v_i = v_{\text{cap}}$ shall be added, so that the time of the last sample is $(t_{\text{exhigh}} + n_{\text{add,medium}} + n_{\text{add,high}} + n_{\text{add,exhigh}})$.

The remaining part of the extra high speed phase (if applicable) of the interim capped speed cycle, which is identical with the same part of the base cycle, shall then be added, so that the time of the last sample is $(1800 + n_{\text{add,medium}} + n_{\text{add,high}} + n_{\text{add,exhigh}})$.

The length of the final capped speed cycle is equivalent to the length of the base cycle except for differences caused by the rounding process according to paragraph 6.1.8. of this Regulation for $n_{\text{add,medium}}$, $n_{\text{add,high}}$ and $n_{\text{add,exhigh}}$.

9.2.3.2.2. $v_{\text{max,medium}} \leq v_{\text{cap}} < v_{\text{max,high}}$

The first part of the final capped speed cycle consists of the vehicle speed trace of the interim capped speed cycle up to the last sample in the high speed phase where $v = v_{\text{cap}}$. The time of this sample is referred to as t_{high} .

Then, $n_{\text{add,high}}$ samples with $v_i = v_{\text{cap}}$ shall be added, so that the time of the last sample is $(t_{\text{high}} + n_{\text{add,high}})$.

The remaining part of the high speed phase of the interim capped speed cycle, which is identical with the same part of the base cycle, shall then be added, so that the time of the last sample is $(1477 + n_{\text{add,high}})$.

In a next step, the first part of the extra high speed phase (if applicable) of the interim capped speed cycle up to the last sample in the extra high speed phase

where $v = v_{\text{cap}}$ shall be added. The time of this sample in the interim capped speed is referred to as t_{exhigh} , so that the time of this sample in the final capped speed cycle is $(t_{\text{exhigh}} + n_{\text{add,high}})$.

Then $n_{\text{add,exhigh}}$ samples with $v_i = v_{\text{cap}}$ shall be added, so that the time of the last sample is $(t_{\text{exhigh}} + n_{\text{add,high}} + n_{\text{add,exhigh}})$.

The remaining part of the extra high speed phase (if applicable) of the interim capped speed cycle, which is identical with the same part of the base cycle, shall then be added, so that the time of the last sample is $(1800 + n_{\text{add,high}} + n_{\text{add,exhigh}})$.

The length of the final capped speed cycle is equivalent to the length of the base cycle except for differences caused by the rounding process according to paragraph 6.1.8. of this Regulation for $n_{\text{add,high}}$ and $n_{\text{add,exhigh}}$.

9.2.3.2.3. $v_{\text{max, high}} \leq v_{\text{cap}} < v_{\text{max, exhigh}}$

The first part of the final capped speed cycle consists of the vehicle speed trace of the interim capped speed cycle up to the last sample in the extra high speed phase where $v = v_{\text{cap}}$. The time of this sample is referred to as t_{exhigh} .

Then, $n_{\text{add,exhigh}}$ samples with $v_i = v_{\text{cap}}$ shall be added, so that the time of the last sample is $(t_{\text{exhigh}} + n_{\text{add,exhigh}})$.

The remaining part of the extra high speed phase of the interim capped speed cycle, which is identical with the same part of the base cycle, shall then be added, so that the time of the last sample is $(1800 + n_{\text{add,exhigh}})$.

The length of the final capped speed cycle is equivalent to the length of the base cycle except for differences caused by the rounding process according to paragraph 6.1.8. of this Regulation for $n_{\text{add,exhigh}}$.

10. Allocation of cycles to vehicles

- 10.1. A vehicle of a certain class shall be tested on the cycle of the same class, i.e. Class 1 vehicles on the Class 1 cycle, Class 2 vehicles on the Class 2 cycle, Class 3a vehicles on the Class 3a cycle, and Class 3b vehicles on the Class 3b cycle. However, at the request of the manufacturer and with approval of the responsible authority, a vehicle may be tested on a numerically higher cycle class, e.g. a Class 2 vehicle may be tested on a Class 3 cycle. In this case the differences between Classes 3a and 3b shall be respected and the cycle may be downscaled according to paragraphs 8. to 8.4. inclusive of this annex.

Annex B2

Gear selection and shift point determination for vehicles equipped with manual transmissions

1. General approach
 - 1.1. The shifting procedures described in this annex shall apply to vehicles equipped with manual shift transmissions.
 - 1.2. The prescribed gears and shifting points are based on the balance between the power required to overcome driving resistance and acceleration, and the power provided by the engine in all possible gears at a specific cycle phase.
 - 1.3. The calculation to determine the gears to use shall be based on engine speeds and full load power curves versus engine speed.
 - 1.4. For vehicles equipped with a dual-range transmission (low and high), only the range designed for normal on-road operation shall be considered for gear use determination.
 - 1.5. The prescriptions for clutch operation shall not be applied if the clutch is operated automatically without the need of an engagement or disengagement of the driver.
 - 1.6. This annex shall not apply to vehicles tested according to Annex B8.

2. Required data and precalculations

The following data are required and calculations shall be performed in order to determine the gears to be used when driving the cycle on a chassis dynamometer:

- (a) P_{rated} , the maximum rated engine power as declared by the manufacturer, kW;
- (b) n_{rated} , the rated engine speed declared by the manufacturer as the engine speed at which the engine develops its maximum power, min^{-1} ;
- (c) n_{idle} , idling speed, min^{-1} .

n_{idle} shall be measured over a period of at least 1 minute at a sampling rate of at least 1 Hz with the engine running in warm condition, the gear lever placed in neutral, and the clutch engaged. The conditions for temperature, peripheral and auxiliary devices, etc. shall be the same as described in Annex B6 for the Type 1 test.

The value to be used in this annex shall be the arithmetic average over the measuring period and rounded according to paragraph 6.1.8. of this Regulation to the nearest 10 min^{-1} ;

- (d) n_g , the number of forward gears.
The forward gears in the transmission range designed for normal on-road operation shall be numbered in descending order of the ratio between engine speed in min^{-1} and vehicle speed in km/h. Gear 1 is the gear with the highest ratio, gear n_g is the gear with the lowest ratio. n_g determines the number of forward gears;
- (e) $(n/v)_i$, the ratio obtained by dividing the engine speed n by the vehicle speed v for each gear i , for $i = 1$ to n_g , $\text{min}^{-1}/(\text{km/h})$. $(n/v)_i$ shall be calculated according to the equations in paragraph 8. of Annex B7;
- (f) f_0, f_1, f_2 , road load coefficients selected for testing, N, N/(km/h), and N/(km/h)² respectively;

- (g) n_{\max}
- $n_{\max 1} = n_{95_high}$, the maximum engine speed where 95 per cent of rated power is reached, min^{-1} ;
- If n_{95_high} cannot be determined because the engine speed is limited to a lower value n_{lim} for all gears and the corresponding full load power is higher than 95 per cent of rated power, n_{95_high} shall be set to n_{lim} .
- $$n_{\max 2} = (n/v)(ng_{v\max}) \times V_{\max, \text{cycle}}$$
- $$n_{\max 3} = (n/v)(ng_{v\max}) \times V_{\max, \text{vehicle}}$$
- where:
- $V_{\max, \text{cycle}}$ is the maximum speed of the vehicle speed trace according to Annex B1, km/h;
- $V_{\max, \text{vehicle}}$ is the maximum speed of the vehicle according to paragraph 2.(i) of this annex, km/h;
- $(n/v)(ng_{v\max})$ is the ratio obtained by dividing engine speed n by the vehicle speed v for the gear $ng_{v\max}$, $\text{min}^{-1}/(\text{km/h})$;
- $ng_{v\max}$ is defined in paragraph 2.(i) of this annex;
- n_{\max} is the maximum of $n_{\max 1}$, $n_{\max 2}$ and $n_{\max 3}$, min^{-1} .
- (h) $P_{\text{wot}}(n)$, the full load power curve over the engine speed range
- The power curve shall consist of a sufficient number of data sets (n , P_{wot}) so that the calculation of interim points between consecutive data sets can be performed by linear interpolation. Deviation of the linear interpolation from the full load power curve according to UN Regulation No. 85 shall not exceed 2 per cent. The first data set shall be at $n_{\text{min_drive_set}}$ (see (k)(3) below) or lower. The last data set shall be at n_{\max} or higher engine speed. Data sets need not be spaced equally but all data sets shall be reported.
- The data sets and the values P_{rated} and n_{rated} shall be taken from the power curve as declared by the manufacturer.
- The full load power at engine speeds not covered by UN Regulation No. 85 shall be determined according to the method described in UN Regulation No. 85;
- (i) Determination of $ng_{v\max}$ and v_{\max}
- $ng_{v\max}$, the gear in which the maximum vehicle speed is reached and shall be determined as follows:
- If $v_{\max}(ng) \geq v_{\max}(ng-1)$ and $v_{\max}(ng-1) \geq v_{\max}(ng-2)$, then:
- $$ng_{v\max} = ng \text{ and } v_{\max} = v_{\max}(ng).$$
- If $v_{\max}(ng) < v_{\max}(ng-1)$ and $v_{\max}(ng-1) \geq v_{\max}(ng-2)$, then:
- $$ng_{v\max} = ng-1 \text{ and } v_{\max} = v_{\max}(ng-1),$$
- otherwise, $ng_{v\max} = ng-2$ and $v_{\max} = v_{\max}(ng-2)$
- where:
- $v_{\max}(ng)$ is the vehicle speed at which the required road load power equals the available power P_{wot} in gear ng (see Figure A2/1a).
- $v_{\max}(ng-1)$ is the vehicle speed at which the required road load power equals the available power P_{wot} in the next lower gear (gear $ng-1$). See Figure A2/1b.

$v_{\max}(ng-2)$ is the vehicle speed at which the required road load power equals the available power P_{wot} in the gear $ng-2$.

Vehicle speed values rounded according to paragraph 6.1.8. of this Regulation to one place of decimal shall be used for the determination of v_{\max} and $ng_{v_{\max}}$.

The required road load power, kW, shall be calculated using the following equation:

$$P_{\text{required}} = \frac{(f_0 \times v) + (f_1 \times v^2) + (f_2 \times v^3)}{3600}$$

where:

v is the vehicle speed specified above, km/h.

The available power at vehicle speed v_{\max} in gear ng , gear $ng - 1$ or gear $ng-2$ shall be determined from the full load power curve, $P_{\text{wot}}(n)$, by using the following equations:

$$n_{ng} = (n/v)_{ng} \times v_{\max}(ng);$$

$$n_{ng-1} = (n/v)_{ng-1} \times v_{\max}(ng-1);$$

$$n_{ng-2} = (n/v)_{ng-2} \times v_{\max}(ng-2),$$

and by reducing the power values of the full load power curve by 10 per cent.

The method described above shall be extended to even lower gears, i.e. $ng- 3$, $ng-4$, etc. if necessary.

If, for the purpose of limiting maximum vehicle speed, the maximum engine speed is limited to n_{lim} which is lower than the engine speed corresponding to the intersection of the road load power curve and the available power curve, then:

$$ng_{v_{\max}} = ng \text{ and } v_{\max} = n_{\text{lim}} / (n/v)(ng).$$

Figure A2/1a
An example where $ng_{v_{\max}}$ is the highest gear

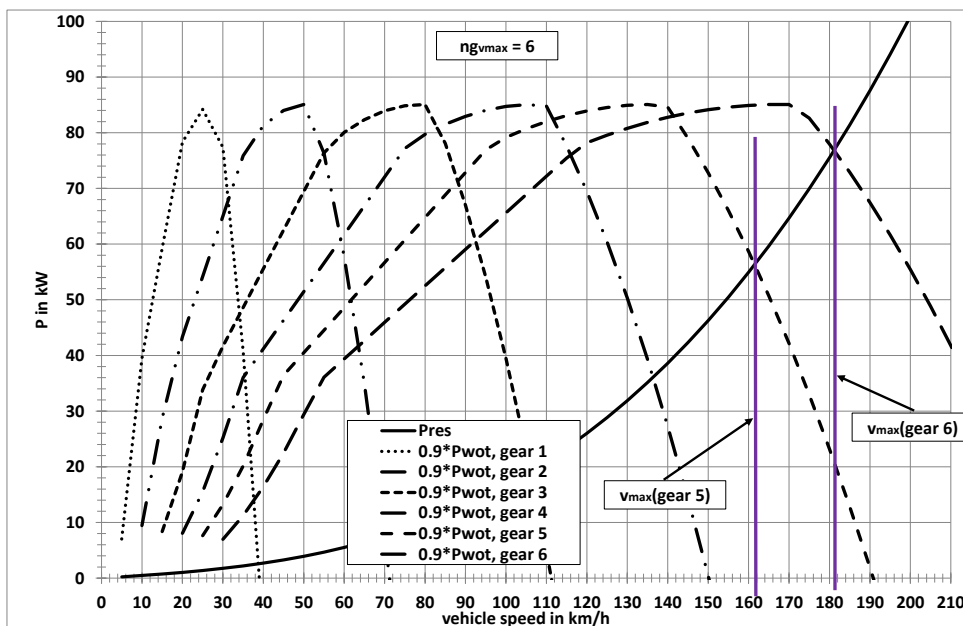
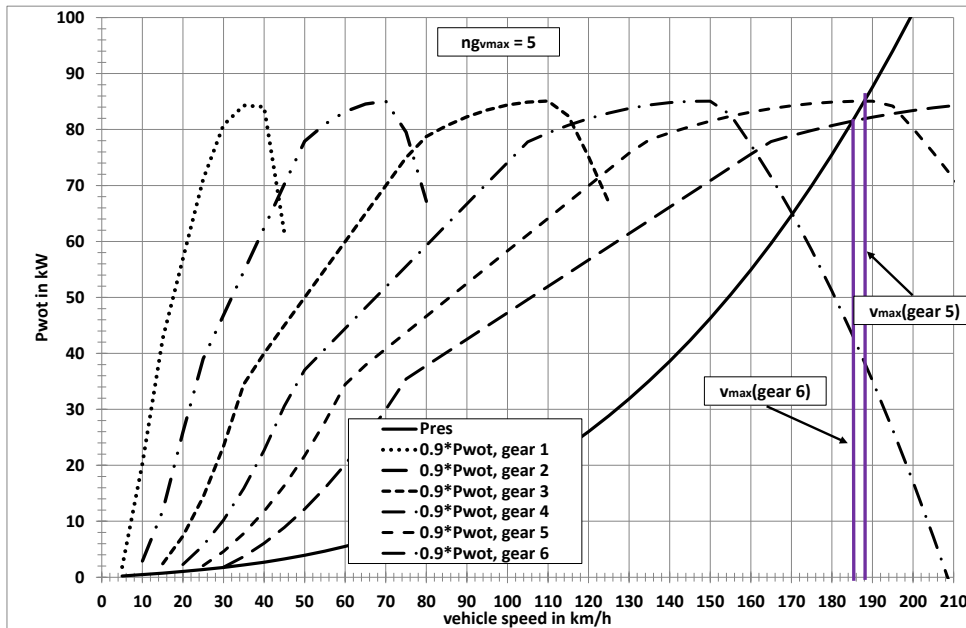


Figure A2/1b
 An example where ng_{vmax} is the 2nd highest gear



(j) Exclusion of a crawler gear

Gear 1 may be excluded at the request of the manufacturer if all of the following conditions are fulfilled:

- (1) The vehicle family is homologated to tow a trailer;
- (2) $(n/v)_1 \times (v_{max} / n_{95_high}) > 6.74$;
- (3) $(n/v)_2 \times (v_{max} / n_{95_high}) > 3.85$;
- (4) The vehicle, having a mass m_t as defined in the equation below, is able to pull away from standstill within 4 seconds, on an uphill gradient of at least 12 per cent, on five separate occasions within a period of 5 minutes.

$$m_t = m_{r0} + 25 \text{ kg} + (MC - m_{r0} - 25 \text{ kg}) \times 0.28$$

(factor 0.28 in the above equation shall be used for category 2 vehicles with a gross vehicle mass up to 3.5 tons and shall be replaced by factor 0.15 in the case of category 1 vehicles),

where:

v_{max} is the maximum vehicle speed as specified in paragraph 2. (i) of this annex. Only the v_{max} value resulting from the intersection of the required road load power curve and the available power curve of the relevant gear shall be used for the conditions in (2) and (3) above. A v_{max} value resulting from a limitation of the engine speed which prevents this intersection of curves shall not be used;

$(n/v)(ng_{vmax})$ is the ratio obtained by dividing the engine speed n by the vehicle speed v for gear ng_{vmax} , $\text{min}^{-1}/(\text{km/h})$;

m_{r0} is the mass in running order, kg;

MC is the technically permissible maximum laden mass of the combination (see paragraph 3.2.27. of this Regulation), kg.

In this case, gear 1 shall not be used when driving the cycle on a chassis dynamometer and the gears shall be renumbered starting with the second gear as gear 1.

(k) Definition of n_{\min_drive}

n_{\min_drive} is the minimum engine speed when the vehicle is in motion, min^{-1} ;

(1) For $n_{\text{gear}} = 1$, $n_{\min_drive} = n_{\text{idle}}$,

(2) For $n_{\text{gear}} = 2$,

(i) for transitions from first to second gear:

$$n_{\min_drive} = 1.15 \times n_{\text{idle}},$$

(ii) for decelerations to standstill:

$$n_{\min_drive} = n_{\text{idle}},$$

(iii) for all other driving conditions:

$$n_{\min_drive} = 0.9 \times n_{\text{idle}}.$$

(3) For $n_{\text{gear}} > 2$, n_{\min_drive} shall be determined by:

$$n_{\min_drive} = n_{\text{idle}} + 0.125 \times (n_{\text{rated}} - n_{\text{idle}}).$$

This value shall be referred to as $n_{\min_drive_set}$.

$n_{\min_drive_set}$ shall be rounded according to paragraph 6.1.8. of this Regulation to the nearest integer.

Values higher than $n_{\min_drive_set}$ may be used for $n_{\text{gear}} > 2$ if requested by the manufacturer. In this case, the manufacturer may specify one value for acceleration/constant speed phases ($n_{\min_drive_up}$) and a different value for deceleration phases ($n_{\min_drive_down}$).

Samples which have acceleration values $\geq -0.1389 \text{ m/s}^2$ shall belong to the acceleration/constant speed phases. This phase specification shall only be used for the determination of the initial gear according to paragraph 3.5. of this annex and shall not be applied to the requirements specified in paragraph 4. of this annex.

In addition, for an initial period of time ($t_{\text{start_phase}}$), the manufacturer may specify higher values ($n_{\min_drive_start}$ or $n_{\min_drive_up_start}$ and $n_{\min_drive_down_start}$) for the values n_{\min_drive} or $n_{\min_drive_up}$ and $n_{\min_drive_down}$ for $n_{\text{gear}} > 2$ than specified above.

The initial time period shall be specified by the manufacturer but shall not exceed the low speed phase of the cycle and shall end in a stop phase so that there is no change of n_{\min_drive} within a short trip.

All individually chosen n_{\min_drive} values shall be equal to or higher than $n_{\min_drive_set}$ but shall not exceed ($2 \times n_{\min_drive_set}$).

All individually chosen n_{\min_drive} values and $t_{\text{start_phase}}$ shall be recorded.

Only $n_{\min_drive_set}$ shall be used as the lower limit for the full load power curve according to paragraph 2(h) above.

(l) TM, test mass of the vehicle, kg.

3. Calculations of required power, engine speeds, available power, and possible gear to be used

3.1. Calculation of required power

For each second j of the cycle trace, the power required to overcome driving resistance and to accelerate shall be calculated using the following equation:

$$P_{\text{required},j} = \left(\frac{(f_0 \times v_j) + (f_1 \times v_j^2) + (f_2 \times v_j^3)}{3600} \right) + \frac{(kr \times a_j \times v_j \times TM)}{3600}$$

where:

$P_{\text{required},j}$ is the required power at second j , kW;
 a_j is the vehicle acceleration at second j , m/s², and is calculated as follows:

$$a_j = \frac{(v_{j+1} - v_j)}{3.6 \times (t_{j+1} - t_j)}$$

$j = t_{\text{start}}$ to $t_{\text{end}} - 1$,

t_{start} is the time at which the applicable test cycle starts (see paragraph 3 of Annex 1 of this Regulation), s;

t_{end} is the time at which the applicable test cycle ends (see paragraph 3 of Annex 1 of this Regulation), s;

The acceleration value at second t_{end} (second 1611 for class 1 cycle and second 1800 for class 2 and 3 cycles) may be set to 0 in order to avoid empty cells.

kr is a factor taking the inertial resistances of the drivetrain during acceleration into account and is set to 1.03.

3.2. Determination of engine speeds

For any $v_j < 1.0$ km/h, it shall be assumed that the vehicle is standing still and the engine speed shall be set to n_{idle} . The gear lever shall be placed in neutral with the clutch engaged except 1 second before beginning an acceleration from standstill where first gear shall be selected with the clutch disengaged.

For each $v_j \geq 1.0$ km/h of the cycle trace and each gear i , $i = 1$ to n_g the engine speed, $n_{i,j}$, shall be calculated using the following equation:

$$n_{i,j} = (n/v)_i \times v_j$$

The calculation shall be performed with floating point numbers; the results shall not be rounded.

3.3. Selection of possible gears with respect to engine speed

The following gears may be selected for driving the speed trace at v_j :

- (a) All gears $i < n_{g_{\text{vmax}}}$ where $n_{\text{min_drive}} \leq n_{i,j} \leq n_{\text{max}1}$;
- (b) All gears $i \geq n_{g_{\text{vmax}}}$ where $n_{\text{min_drive}} \leq n_{i,j} \leq n_{\text{max}2}$;
- (c) Gear 1, if $n_{1,j} < n_{\text{min_drive}}$.

If $a_j < 0$ and $n_{i,j} \leq n_{\text{idle}}$, $n_{i,j}$ shall be set to n_{idle} and the clutch shall be disengaged.

If $a_j \geq 0$ and $n_{i,j} < \max(1.15 \times n_{\text{idle}}; \text{min. engine speed of the } P_{\text{wot}}(n) \text{ curve})$, $n_{i,j}$ shall be set to the maximum of $(1.15 \times n_{\text{idle}})$ or the min. engine speed of the $P_{\text{wot}}(n)$ curve, and the clutch shall be set to "undefined".

"Undefined" covers any status of the clutch between disengaged and engaged, depending on the individual engine and transmission design. In such a case, the real engine speed may deviate from the calculated engine speed.

With regard to the definition of $n_{\text{min_drive}}$ in paragraph 2 (k) the requirements (a) to (c) specified above can be expressed as follows for deceleration phases:

During a deceleration phase, gears with $n_{\text{gear}} > 2$ shall be used as long as the engine speed does not drop below $n_{\text{min_drive}}$.

Gear 2 shall be used during a deceleration phase within a short trip of the cycle (not at the end of a short trip) as long as the engine speed does not drop below $(0.9 \times n_{\text{idle}})$.

If the engine speed drops below n_{idle} , the clutch shall be disengaged.

If the deceleration phase is the last part of a short trip shortly before a stop phase, the second gear shall be used as long as the engine speed does not drop below n_{idle} . This requirement shall be applied to the whole deceleration phase ending at standstill.

A deceleration phase is a time period of more than 2 seconds with a vehicle speed ≥ 1.0 km/h and with strictly monotonic decrease of vehicle speed (see paragraph 4. of this annex).

3.4. Calculation of available power

For each engine speed value n_k of the full load power curve as specified in paragraph 2 (h) of this annex the available power shall be calculated using the following equation:

$$P_{available_k} = P_{wot}(n_k) \times (1 - (SM + ASM))$$

where:

P_{rated} is the rated power, kW;

P_{wot} is the power available at $n_{i,j}$ at full load condition from the full load power curve;

SM is a safety margin accounting for the difference between the stationary full load condition power curve and the power available during transition conditions. SM shall be set to 10 per cent;

ASM is an additional power safety margin which may be applied at the request of the manufacturer.

When requested, the manufacturer shall provide the ASM values (in per cent reduction of the wot power) together with data sets for $P_{wot}(n)$ as shown by the example in Table A2/1. Linear interpolation shall be used between consecutive data points. ASM is limited to 50 per cent.

The application of an ASM requires the approval of the responsible authority.

Table A2/1

n	P_{wot}	SM per cent	ASM per cent	$P_{available}$
min^{-1}	kW			kW
700	6.3	10.0	20.0	4.4
1000	15.7	10.0	20.0	11.0
1500	32.3	10.0	15.0	24.2
1800	56.6	10.0	10.0	45.3
1900	59.7	10.0	5.0	50.8
2000	62.9	10.0	0.0	56.6
3000	94.3	10.0	0.0	84.9
4000	125.7	10.0	0.0	113.2
5000	157.2	10.0	0.0	141.5
5700	179.2	10.0	0.0	161.3
5800	180.1	10.0	0.0	162.1
6000	174.7	10.0	0.0	157.3
6200	169.0	10.0	0.0	152.1
6400	164.3	10.0	0.0	147.8
6600	156.4	10.0	0.0	140.8

For each possible gear i and each vehicle speed value of the cycle trace v_j (j as specified in paragraph 3.1 of this annex) and each engine speed value $n_{ij} \geq n_{min}$ of the full load power curve the available power shall be calculated from adjacent n_k , $P_{available_k}$ values of the full load power curve by linear interpolation.

3.5. Determination of possible gears to be used

The possible gears to be used shall be determined by the following conditions:

- (a) The conditions of paragraph 3.3. of this annex are fulfilled, and
- (b) For $n_{gear} > 2$, if $P_{available_i,j} \geq P_{required,j}$.

The initial gear to be used for each second j of the cycle trace is the highest final possible gear, i_{max} . When starting from standstill, only the first gear shall be used.

The lowest final possible gear is i_{min} .

4. Additional requirements for corrections and/or modifications of gear use

The initial gear selection shall be checked and modified in order to avoid too frequent gearshifts and to ensure driveability and practicality.

An acceleration phase is a time period of more than 2 seconds with a vehicle speed ≥ 1.0 km/h and with strictly monotonic increase of vehicle speed. A deceleration phase is a time period of more than 2 seconds with a vehicle speed ≥ 1.0 km/h and with strictly monotonic decrease of vehicle speed. A constant speed phase is a time period of more than 2 seconds with a constant vehicle speed ≥ 1.0 km/h.

The end of an acceleration/deceleration phase is determined by the last time sample in which the vehicle speed is higher/lower than the vehicle speed of the previous time sample. In this context the end of a deceleration phase could be the beginning of an acceleration phase. In this case the requirements for acceleration phases overrule the requirements for deceleration phases.

Corrections and/or modifications shall be made according to the following requirements:

- (a) The modification check described in paragraph 4.(a) of this annex shall be applied to the complete cycle trace twice prior to the application of the following paragraphs of this annex.

If a one step higher gear (n+1) is required for only 1 second and the gears before and after are the same (n) or one of them is one step lower (n - 1), gear (n + 1) shall be corrected to gear n.

Examples:

Gear sequence i - 1, i, i - 1 shall be replaced by:

i - 1, i - 1, i - 1;

Gear sequence i - 1, i, i - 2 shall be replaced by:

i - 1, i - 1, i - 2;

Gear sequence i - 2, i, i - 1 shall be replaced by:

i - 2, i - 1, i - 1.

If, during acceleration or constant speed phases or transitions from constant speed to acceleration or acceleration to constant speed phases where these phases only contain upshifts, a gear is used for only one second, the gear in the following second shall be corrected to the gear before, so that a gear is used for at least 2 seconds.

Examples:

Gear sequence 1, 2, 3, 3, 3, 3, 3 shall be replaced by:

1, 1, 2, 2, 3, 3, 3.

Gear sequence 1, 2, 3, 4, 5, 5, 6, 6, 6, 6, 6 shall be replaced by:

1, 1, 2, 2, 3, 3, 4, 4, 5, 5, 6.

This requirement shall not be applied to downshifts during an acceleration phase or if the use of a gear for just one second follows immediately after such a downshift or if the downshift occurs right at the beginning of an acceleration phase. In these cases, the downshifts shall be first corrected according to paragraph 4.(b) of this annex.

Example:

Gear sequence 4, 4, 3, 4, 5, 5, 5, where the first second or the third second determines the start of an acceleration phase and where paragraph 4.(b) does not apply in the further course of the acceleration phase, shall be replaced by:

4, 4, 4, 4, 5, 5, 5.

However, if the gear at the beginning of an acceleration phase is one step lower than the gear in the previous second and the gears in the following (up to five) seconds are the same as the gear in the previous second but followed by a downshift, so that the application of paragraph 4.(c) would correct them to the same gear as at the beginning of the acceleration phase, the application of paragraph 4.(c) should be performed instead.

Example:

For a speed trace sequence

19.6 18.3 18.0 18.3 18.5 17.9 15.0 km/h

with an initial gear use of

3 3 2 3 3 2 2,

the gears in the fourth and fifth second shall be corrected to a one step lower gear (which would be done by an application of paragraph 4.(c)) instead of a correction of the gear at the beginning of the acceleration phase (second three), so that the correction results in the following gear sequence

3 3 2 2 2 2 2

Furthermore, if the gear in the first second of an acceleration phase is the same as the gear in the previous second and the gear in the following seconds is one step higher, the gear in the 2nd second of the acceleration phase shall be replaced by the gear used in the first second of the acceleration phase.

Example:

For a speed trace sequence

30.9 25.5 21.4 20.2 22.9 26.6 30.2 km/h

with an initial gear use of

3 3 2 2 3 3 3,

the gear in the fifth second (the 2nd second of the acceleration phase) shall be corrected to a one step lower gear in order to ensure the use of a gear within the acceleration phase for at least two seconds, so that the correction results in the following gear sequence

3 3 2 2 2 3 3

Gears shall not be skipped during upshifts within acceleration phases.

However, an upshift by two gears is permitted at the transition from an acceleration phase to a constant speed phase if the duration of the constant speed phase exceeds 5 seconds.

- (b) If a downshift is required during an acceleration phase or at the beginning of the acceleration phase, the gear required during this downshift shall be noted (i_{DS}). The starting point of a correction procedure is defined by either the last previous second when i_{DS} was identified or by the starting point of the acceleration phase if all time samples before have gears $> i_{DS}$. The highest gear of the time samples before the downshift determines the reference gear i_{ref} for the downshift. A downshift where $i_{DS} = i_{ref} - 1$ is referred to as a one step downshift, a downshift where $i_{DS} = i_{ref} - 2$ is referred to as a two step downshift, a downshift where $i_{DS} = i_{ref} - 3$ is referred to as a three step downshift. The following check shall then be applied.

- (i) One step downshifts

Working forward from the starting point of the correction procedure to the end of the acceleration phase, the latest occurrence of a 10 second window containing i_{DS} for either 2 or more consecutive seconds, or 2 or more individual seconds, shall be identified. The last usage of i_{DS} in this window defines the end point of the correction procedure. Between the start and end of the correction period, all requirements for gears greater than i_{DS} shall be corrected to a requirement of i_{DS} .

From the end of the correction period (in case of 10 second windows containing i_{DS} for either 2 or more consecutive seconds, or 2 or more individual seconds) or from the starting point of the correction procedure (in case that all 10 second windows contain i_{DS} only for one second or some 10 second windows contain no i_{DS} at all) to the end of the acceleration phase all downshifts with a duration of only one second shall be removed.

(ii) Two or three step downshifts

Working forward from the starting point of the correction procedure to the end of the acceleration phase, the latest occurrence of i_{DS} shall be identified. From the starting point of the correction procedure all requirements for gears greater than or equal to i_{DS} up to the latest occurrence of i_{DS} shall be corrected to $(i_{DS} + 1)$.

(iii) One step downshifts and two step and/or three step downshifts

If one step downshifts as well as two step and/or three step downshifts occur during an acceleration phase, three step downshifts shall be corrected before two or one step downshifts are corrected and two step downshifts shall be corrected before one step downshifts are corrected. In such cases, the starting point of the correction procedure for the two or one step downshifts is the second immediately following the end of the correction period for the three step downshifts and the starting point of the correction procedure for the one step downshifts is the second immediately following the end of the correction period for the two step downshifts. If a three step downshift occurs after a one or two step downshift, it shall overrule these downshifts in the time period before the three step downshift. If a two step downshift occurs after a one step downshift, it shall overrule the one step downshift in the time period before the two step downshift.

Examples are shown in Tables A2/2 to A2/6.

Table A2/2

Time	j	j+1	j+2	j+3	j+4	j+5	j+6	j+7	j+8	j+9	j+10	j+11	j+12	j+13	j+14	j+15	j+16	j+17	j+18
	Start of accel.								Down shift, $i_{DS} = 3$							Down shift, $i_{DS} = 3$			End of accel.
Initial gear use	2	2	3	3	4	4	4	4	3	4	4	4	4	4	4	3	4	4	4
				Start of correction check															
					$i_{ref} = 4$														
					First 10 second window for the correction check										Last 10 second window for the correction check				
					Latest 10 second window containing i_{DS} twice														
																End of correction			
Correction Removal					3	3	3	3		3	3	3	3	3	3	3			
Final gear use	2	2	3	3	3	3	3	3	3	3	3	3	3	3	3	3	4	4	4

Table A2/3

Time	j	j+1	j+2	j+3	j+4	j+5	j+6	j+7	j+8	j+9	j+10	j+11	j+12	j+13	j+14	j+15	j+16	j+17	j+18
	Start of accel.						Down shift, $i_{DS} = 3$											Down shift, $i_{DS} = 3$	End of accel.
Initial gear use	2	2	3	3	4	4	3	4	4	4	4	4	4	4	4	4	4	3	4
				Start of correction check															
					$i_{ref} = 4$														
					First 10 second window for the correction check										Last 10 second window for the correction check				
					Latest 10 second window containing i_{DS} twice														
							End of correction												
Correction Removal					3	3													4
Final gear use	2	2	3	3	3	3	3	4	4	4	4	4	4	4	4	4	4	4	4

Table A2/4

Time	j	j+1	j+2	j+3	j+4	j+5	j+6	j+7	j+8	j+9	j+10	j+11	j+12	j+13	j+14	j+15	j+16	j+17	j+18	
	Start of accel.			Down shift, $i_{DS} = 3$											Down shift, $i_{DS} = 3$				End of accel.	
Initial gear use	4	4	4	3	4	4	4	4	4	4	4	4	4	4	3	4	4	5	5	
	Start of correction check																			
	$i_{ref} = 4$																			
	First 10 second window for the correction check										Last 10 second window for the correction check									
	no 10 second window containing i_{DS} twice																			
Correction Removal				4											4					
Final gear use	4	4	4	4	4	4	4	4	4	4	4	4	4	4	4	4	4	5	5	

Table A2/5

Time	j	j+1	j+2	j+3	j+4	j+5	j+6	j+7	j+8	j+9	j+10	j+11	j+12	j+13	j+14	j+15	j+16	j+17	j+18	j+19
	Start of accel.			Down shift, $i_{DS1} = 5$		Down shift by 2 steps, $i_{DS1} = 4$													Down shift by 1 step, $i_{DS2} = 5$	End of accel.
Initial gear use	6	6	6	5	5	4	4	4	4	4	5	6	6	6	6	6	6	6	5	5
	Start of correction check for i_{DS1}										Start of correction check for i_{DS2}									
	$i_{ref} = 6$										$i_{ref} = 6$									
	Latest 10 second window containing i_{DS1} twice or more										Latest 10 second window containing i_{DS2} twice or more									
				End of correction for i_{DS1}															End of correction for i_{DS2}	
Correction Removal	4	4	4	4	4						5	5	5	5	5	5	5	5		
Final gear use	4	4	4	4	4	4	4	4	4	4	5	5	5	5	5	5	5	5	5	5

Table A2/6

Time	j	j+1	j+2	j+3	j+4	j+5	j+6	j+7	j+8	j+9	j+10	j+11	j+12	j+13	j+14	j+15	j+16	j+17	j+18	
	Start of accel.	Down shift, $i_{DS1} = 3$					Down shift, $i_{DS2} = 4$							Down shift, $i_{DS3} = 5$					End of accel.	
Initial gear use	4	3	3	4	5	5	4	5	5	6	6	6	6	5	5	6	6	6	6	
	Start of correction check i_{DS1}			Start of correction check i_{DS2}				Start of correction check i_{DS3}												
	$i_{ref} = 4$			$i_{ref} = 5$						$i_{ref} = 6$										
	Latest 10 second window containing i_{DS1} twice or more										Latest 10 second window containing i_{DS2} twice or more									
	Latest 10 second window containing i_{DS3} twice or more										Latest 10 second window containing i_{DS3} twice or more									
	End of correction i_{DS1}				End of correction i_{DS2}							End of correction i_{DS3}								
correction removal	3				4	4				5	5	5	5							
Final gear use	3	3	3	4	4	4	4	5	5	5	5	5	5	5	5	6	6	6	6	

This correction shall not be performed for gear 1. The requirements of the 3rd sub-paragraph of paragraph 3.3. (If $a_j \geq 0 \dots$) shall not be applied for gear corrections described in this paragraph for gears > 2.

- (c) The modification check described in paragraph 4.(c) of this annex shall be applied to the complete cycle trace twice prior to the application of paragraphs 4.(d) to 4.(f) of this annex.

If gear i is used for a time sequence of 1 to 5 seconds and the gear prior to this sequence is one step lower and the gear after this sequence is one or two steps lower than within this sequence or the gear prior to this sequence is two steps lower and the gear after this sequence is one step lower than within the sequence, the gear for the sequence shall be corrected to the maximum of the gears before and after the sequence.

Examples:

(i) Gear sequence $i-1, i, i-1$ shall be replaced by:

$i-1, i-1, i-1$;

Gear sequence $i-1, i, i-2$ shall be replaced by:

$i-1, i-1, i-2$;

Gear sequence $i-2, i, i-1$ shall be replaced by:

$i-2, i-1, i-1$.

(ii) Gear sequence $i-1, i, i, i-1$ shall be replaced by:

$i-1, i-1, i-1, i-1$;

Gear sequence $i-1, i, i, i-2$ shall be replaced by:

$i-1, i-1, i-1, i-2$;

Gear sequence $i-2, i, i, i-1$ shall be replaced by:

$i-2, i-1, i-1, i-1$.

(iii) Gear sequence $i-1, i, i, i, i-1$ shall be replaced by:

$i-1, i-1, i-1, i-1, i-1$;

Gear sequence $i-1, i, i, i, i-2$ shall be replaced by:

$i-1, i-1, i-1, i-1, i-2$;

Gear sequence $i-2, i, i, i, i-1$ shall be replaced by:

$i-2, i-1, i-1, i-1, i-1$.

(iv) Gear sequence $i-1, i, i, i, i, i-1$ shall be replaced by:

$i-1, i-1, i-1, i-1, i-1, i-1$;

Gear sequence $i-1, i, i, i, i, i-2$ shall be replaced by:

$i-1, i-1, i-1, i-1, i-1, i-2$;

Gear sequence $i-2, i, i, i, i, i-1$ shall be replaced by:

$i-2, i-1, i-1, i-1, i-1, i-1$.

(v) Gear sequence $i-1, i, i, i, i, i, i-1$ shall be replaced by:

$i-1, i-1, i-1, i-1, i-1, i-1, i-1$;

Gear sequence $i-1, i, i, i, i, i, i-2$ shall be replaced by:

$i-1, i-1, i-1, i-1, i-1, i-1, i-2$;

Gear sequence $i-2, i, i, i, i, i, i-1$ shall be replaced by:

$i-2, i-1, i-1, i-1, i-1, i-1, i-1$.

In all cases (i) to (v), $i-1 \geq i_{\min}$ shall be fulfilled.

- (d) No upshift to a higher gear shall be performed within a deceleration phase.
- (e) No upshift to a higher gear at the transition from an acceleration or constant speed phase to a deceleration phase shall be performed if one of the gears in the first two seconds following the end of the deceleration phase is lower than the upshifted gear or is gear 0.

Example:

If $v_i \leq v_{i+1}$ and $v_{i+2} < v_{i+1}$ and gear $i = 4$ and gear $(i + 1 = 5)$ and gear $(i + 2 = 5)$, then gear $(i + 1)$ and gear $(i + 2)$ shall be set to 4 if the gear for the phase following the deceleration phase is gear 4 or lower. For all

following cycle trace points with gear 5 within the deceleration phase, the gear shall also be set to 4. If the gear following the deceleration phase is gear 5, an upshift shall be performed.

If there is an upshift during the transition and the initial deceleration phase by 2 gears, an upshift by 1 gear shall be performed instead. In this case, no further modifications shall be performed in the following gear use checks.

(f) Other gear modifications for deceleration phases

A downshift to first gear is not permitted during deceleration phases. If such a downshift would be necessary in the last part of a short trip just before a stop phase, since the engine speed would drop below n_{idle} in 2nd gear, gear 0 shall be used instead and the gear lever shall be placed in neutral and the clutch shall be engaged.

If the first gear is required in a time period of at least 2 seconds immediately before a deceleration to stop, this gear should be used until the first sample of the deceleration phase. For the rest of the deceleration phase, gear 0 shall be used and the gear lever shall be placed in neutral and the clutch shall be engaged.

If during a deceleration phase the duration of a gear period (a time sequence with constant gear) between two gear periods of 3 seconds or more is only 1 second, it shall be replaced by gear 0 and the clutch shall be disengaged.

If during a deceleration phase the duration of a gear period between two gear periods of 3 seconds or more is 2 seconds, it shall be replaced by gear 0 for the 1st second and for the 2nd second with the gear that follows after the 2 second period. The clutch shall be disengaged for the 1st second.

Example: A gear sequence 5, 4, 4, 2 shall be replaced by 5, 0, 2, 2.

This requirement shall only be applied if the gear that follows after the 2 second period is > 0 .

If several gear periods with durations of 1 or 2 seconds follow one another, corrections shall be performed as follows:

A gear sequence $i, i, i, i - 1, i - 1, i - 2$ or $i, i, i, i - 1, i - 2, i - 2$ shall be changed to $i, i, i, 0, i - 2, i - 2$.

A gear sequence such as $i, i, i, i - 1, i - 2, i - 3$ or $i, i, i, i - 2, i - 2, i - 3$ or other possible combinations shall be changed to $i, i, i, 0, i - 3, i - 3$.

This change shall also be applied to gear sequences where the acceleration is ≥ 0 for the first 2 seconds and < 0 for the 3rd second or where the acceleration is ≥ 0 for the last 2 seconds.

For extreme transmission designs, it is possible that gear periods with durations of 1 or 2 seconds following one another may last up to 7 seconds. In such cases, the correction above shall be complemented by the following correction requirements in a second step.

A gear sequence $j, 0, i, i, i - 1, k$ with $j > (i + 1)$ and $k \leq (i - 1)$ but $k > 0$ shall be changed to $j, 0, i - 1, i - 1, i - 1, k$, if gear $(i - 1)$ is one or two steps below i_{max} for second 3 of this sequence (one after gear 0).

If gear $(i - 1)$ is more than two steps below i_{max} for second 3 of this sequence, a gear sequence $j, 0, i, i, i - 1, k$ with $j > (i + 1)$ and $k \leq (i - 1)$ but $k > 0$ shall be changed to $j, 0, 0, k, k, k$.

A gear sequence $j, 0, i, i-2, k$ with $j > (i + 1)$ and $k \leq (i - 2)$ but $k > 0$ shall be changed to $j, 0, i - 2, i - 2, i - 2, k$, if gear $(i - 2)$ is one or two steps below i_{\max} for second 3 of this sequence (one after gear 0).

If gear $(i - 2)$ is more than two steps below i_{\max} for second 3 of this sequence, a gear sequence $j, 0, i, i, i - 2, k$ with $j > (i + 1)$ and $k \leq (i - 2)$ but $k > 0$ shall be changed to $j, 0, 0, k, k, k$.

In all cases specified above in this sub-paragraph (paragraph 4.(f) of this annex), the clutch disengagement (gear 0) for 1 second is used in order to avoid too high engine speeds for this second. If this is not an issue and, if requested by the manufacturer, it is allowed to use the lower gear of the following second directly instead of gear 0 for downshifts of up to 3 steps. The use of this option shall be recorded.

If the deceleration phase is the last part of a short trip shortly before a stop phase and the last gear > 0 before the stop phase is used only for a period of up to 2 seconds, gear 0 shall be used instead and the gear lever shall be placed in neutral and the clutch shall be engaged.

Examples: A gear sequence of 4, 0, 2, 2, 0 for the last 5 seconds before a stop phase shall be replaced by 4, 0, 0, 0, 0. A gear sequence of 4, 3, 3, 0 for the last 4 seconds before a stop phase shall be replaced by 4, 0, 0, 0.

5. Final requirements

- (a) Paragraphs 4.(a) to 4.(f) inclusive of this annex shall be applied sequentially, scanning the complete cycle trace in each case. Since modifications to paragraphs 4.(a) to 4.(f) inclusive of this annex may create new gear use sequences, these new gear sequences shall be checked twice and modified if necessary.
- (b) After the application of paragraph 4.(b) of this annex, a downshift by more than one gear could occur at the transition from a deceleration or constant speed phase to an acceleration phase.

In this case, the gear for the last sample of the deceleration or constant speed phase shall be replaced by gear 0 and the clutch shall be disengaged. If the “suppress gear 0 during downshifts” option according to paragraph 4.(f) of this annex is chosen, the gear of the following second (first second of the acceleration phase) shall be used instead of gear 0.

- (c) In order to enable the assessment of the correctness of the calculation, the checksum of $v \cdot \text{gear}$ for $v \geq 1.0$ km/h, rounded according to paragraph 6.1.8. of this Regulation to four places of decimal, shall be calculated and recorded.

Research octane number, RON ^(c)		95.0	98.0	EN ISO 5164 JIS K2280
Motor octane number, MON ^(c)		85.0	89.0	EN ISO 5163 JIS K2280
Density at 15 °C	kg/m ³	743.0	756.0	EN ISO 12185 JIS K2249
Vapour pressure	kPa	56.0	60.0	EN 13016-1 JIS K2258
Water content	% v/v		0.05	EN 12937
Appearance at -7 °C		clear and bright		
Distillation:				
— evaporated at 70 °C	% v/v	34.0	46.0	EN-ISO 3405
— evaporated at 100 °C	% v/v	54.0	62.0	EN-ISO 3405
— evaporated at 150 °C	% v/v	86.0	94.0	EN-ISO 3405
— final boiling point	°C	170	195	EN-ISO 3405
Residue	% v/v		2.0	EN-ISO 3405
Hydrocarbon analysis:				
— olefins	% v/v	6.0	13.0	EN 22854 JIS K2536-1 JIS K2536-2
— aromatics	% v/v	25.0	32.0	EN 22854 JIS K2536-1 JIS K2536-2 JIS K2536-3
— benzene	% v/v		1.00	EN 22854 EN 238 JIS K2536-2 JIS K2536-3 JIS K2536-4
— saturates	% v/v		To be recorded	EN 22854
Carbon/hydrogen ratio			To be recorded	
Carbon/oxygen ratio			To be recorded	
Induction period ^(d)	minutes	480		EN-ISO 7536
Oxygen content ^(e)	% m/m	3.3	3.7	EN 22854 JIS K2536-2 JIS K2536-4 JIS K2536-6
Solvent washed gum (Existent gum content)	mg/100ml		4	EN-ISO 6246 JIS K2261
Sulphur content ^(f)	mg/kg		10	EN ISO 20846 EN ISO 20884 JIS K2541-1 JIS K2541-2 JIS K2541-6 JIS K2541-7
Copper corrosion			Class 1	EN-ISO 2160
Lead content	mg/l		5	EN 237 JIS K2255
Phosphorus content ^(g)	mg/l		1.3	ASTM D 3231

Ethanol ^(e)	% v/v	9.0	10.0	EN 22854 JIS K2536-2 JIS K2536-4 JIS K2536-6
------------------------	-------	-----	------	---

^(a) The values quoted in the specifications are 'true values'. In establishing of their limit values the terms of ISO 4259 "Petroleum products - Determination and application of precision data in relation to methods of test" have been applied and in fixing a minimum value, a minimum difference of 2R above zero has been taken into account; in fixing a maximum and minimum value, the minimum difference is 4R (R = reproducibility).

Notwithstanding this measure, which is necessary for technical reasons, the manufacturer of fuels shall nevertheless aim at a zero value where the stipulated maximum value is 2R and at the mean value in the case of quotations of maximum and minimum limits. Should it be necessary to clarify whether a fuel meets the requirements of the specifications, the terms of ISO 4259 shall be applied.

^(b) Equivalent EN/ISO methods will be adopted when issued for properties listed above.

^(c) A correction factor of 0.2 for MON and RON shall be subtracted for the calculation of the final result in accordance with EN 228:2008.

^(d) The fuel may contain oxidation inhibitors and metal deactivators normally used to stabilise refinery gasoline streams, but detergent/dispersive additives and solvent oils shall not be added.

^(e) Ethanol is the only oxygenate that shall be intentionally added to the reference fuel. The Ethanol used shall conform to EN 15376.

^(f) The actual sulphur content of the fuel used for the Type 1 test shall be recorded.

^(g) There shall be no intentional addition of compounds containing phosphorus, iron, manganese, or lead to this reference fuel.

3.7. Ethanol (nominal 95 RON, E85)

Table A3/7

Ethanol (nominal 95 RON, E85)

Parameter	Unit	Limits ^(a)		Test method ^(b)
		Minimum	Maximum	
Research octane number, RON		95		EN ISO 5164
Motor octane number, MON		85		EN ISO 5163
Density at 15 °C	kg/m ³	To be recorded		ISO 3675
Vapour pressure	kPa	40	60	EN ISO 13016-1 (DVPE)
Sulphur content ^{(c)(d)}	mg/kg		10	EN ISO 20846 EN ISO 20884
Oxidation stability	minutes	360		EN ISO 7536
Existent gum content (solvent washed)	mg/100ml		5	EN-ISO 6246
Appearance: This shall be determined at ambient temperature or 15 °C whichever is higher.		Clear and bright, visibly free of suspended or precipitated contaminants		Visual inspection
Ethanol and higher alcohols ^(g)	% v/v	83	85	EN 1601 EN 13132 EN 14517
Higher alcohols (C3-C8)	% v/v		2	
Methanol	% v/v		0.5	
Petrol ^(e)	% v/v	Balance		EN 228
Phosphorus	mg/l	0.3 ^(f)		ASTM D 3231
Water content	% v/v		0.3	ASTM E 1064
Inorganic chloride content	mg/l		1	ISO 6227
pHe		6.5	9	ASTM D 6423
Copper strip corrosion (3h at 50 °C)	Rating	Class 1		EN ISO 2160
Acidity, (as acetic acid CH ₃ COOH)	% (m/m) (mg/l)		0.005-40	ASTM D 1613
Carbon/hydrogen ratio		Record		
Carbon/oxygen ratio		Record		

^(a) The values quoted in the specifications are 'true values'. In establishing of their limit values the terms of ISO 4259 "Petroleum products — Determination and application of precision data in relation to methods of test" have been applied and in fixing a minimum value, a minimum difference of 2R above zero has been taken into account; in fixing a maximum and minimum value, the minimum difference is 4R (R = reproducibility). Notwithstanding this measure, which is necessary for technical reasons, the manufacturer of fuels shall nevertheless aim at a zero value where the stipulated maximum value is 2R and at the mean value in the case of quotations of maximum and minimum limits. Should it be necessary to clarify whether a fuel meets the requirements of the specifications, the terms of ISO 4259 shall be applied.

^(b) In cases of dispute, the procedures for resolving the dispute and interpretation of the results based on test method precision, described in EN ISO 4259 shall be used.

^(c) In cases of national dispute concerning sulphur content, either EN ISO 20846 or EN ISO 20884 shall be called up (similar to the reference in the national Annex of EN 228).

^(d) The actual sulphur content of the fuel used for the Type 1 test shall be recorded.

^(e) The unleaded petrol content can be determined as 100 minus the sum of the percentage content of water and alcohols.

^(f) There shall be no intentional addition of compounds containing phosphorus, iron, manganese, or lead to this reference fuel.

^(g) Ethanol to meet specification of EN 15376 is the only oxygenate that shall be intentionally added to this reference fuel.

4. Technical data on gaseous fuels for testing vehicles with positive-ignition engines

4.1. LPG (A and B)

Table A3/8

LPG (A and B)

<i>Parameter</i>	<i>Unit</i>	<i>Fuel E1</i>	<i>Fuel E2</i>	<i>Fuel J</i>	<i>Fuel K</i>	<i>Test method</i>
Composition:						ISO 7941
C3-content	% vol	30 ±2	85 ±2		Winter: min. 15, max. 35 Summer: max. 10	KS M ISO 7941
Propane and propylene content	% mole			Min 20, max 30		JIS K2240
C4-content	% vol	Balance			Winter: min.60, Summer: min. 85	KS M ISO 7941
Butane and butylene content				Min 70, max 80		JIS K2240
Butadiene					max. 0.5	KS M ISO 7941
< C3, > C4	% vol	Max. 2	Max. 2			
Olefins	% vol	Max. 12	Max. 15			
Evaporation residue	mg/kg	Max. 50	Max. 50			EN 15470
Evaporation residue (100ml)	ml	-			0.05	ASTM D2158
Water at 0 °C		Free				EN 15469
Total sulphur content	mg/kg	Max. 10	Max 10			ASTM 6667
					Max 40	KS M 2150, ASTM D4486, ASTM D5504
Hydrogen sulphide		None	None			ISO 8819
Copper strip corrosion	rating	Class 1	Class 1			ISO 6251 ^(a)
Copper corrosion	40 °C, 1h	-			1	KS M ISO 6251
Odour		Characteristic				
Motor octane number		Min. 89	Min. 89			EN 589 Annex B
Vapour pressure (40 °C)	MPa	-	1.27			KS M ISO 4256 KS M ISO 8973
Density (15 °C)	kg/m ³	500			620	KS M 2150, KS M ISO 3993 KS M ISO 8973

^(a) This method may not accurately determine the presence of corrosive materials if the sample contains corrosion inhibitors or other chemicals which diminish the corrosivity of the sample to the copper strip. Therefore, the addition of such compounds for the sole purpose of biasing the test method is prohibited.

4.2. NG/biomethane

4.2.1. "G20" "High Gas" (nominal 100 per cent Methane)

Table A3/9

"G20" "High Gas" (nominal 100 per cent methane)

Characteristics	Units	Basis	Limits		Test method
			Minimum	Maximum	
Composition:					
Methane	% mole	100	99	100	ISO 6974
Balance ^(a)	% mole	—	—	1	ISO 6974
N ₂	% mole				ISO 6974
Sulphur content	mg/m ³ ^(b)	—	—	10	ISO 6326-5
Wobbe Index (net)	MJ/m ³ ^(c)	48.2	47.2	49.2	

^(a) Inerts (different from N₂) + C₂ + C₂+

^(b) Value to be determined at 293.15 K (20 °C) and 101.325 kPa.

^(c) Value to be determined at 273.15 K (0 °C) and 101.325 kPa.

4.2.2. [Reserved]

4.2.3. "G25" "Low Gas" (nominal 86 per cent Methane)

Table A3/11

"G25" "Low Gas" (nominal 86 per cent methane)

Characteristics	Units	Basis	Limits		Test method
			Minimum	Maximum	
Composition:					
Methane	% mole	86	84	88	ISO 6974
Balance ^(a)	% mole	—	—	1	ISO 6974
N ₂	% mole	14	12	16	ISO 6974
Sulphur content	mg/m ³ ^(b)	—	—	10	ISO 6326-5
Wobbe Index (net)	MJ/m ³ ^(c)	39.4	38.2	40.6	

^(a) Inerts (different from N₂) + C₂ + C₂+

^(b) Value to be determined at 293.15 K (20 °C) and 101.325 kPa.

^(c) Value to be determined at 273.15 K (0 °C) and 101.325 kPa.

4.2.4. "J-Gas" (nominal 85 per cent Methane)

Table A3/12

"J-Gas" (nominal 85 per cent methane)

<i>Characteristics</i>	<i>Units</i>	<i>Limits</i>	
		<i>Minimum</i>	<i>Maximum</i>
Methane	% mole	85	
Ethane	% mole		10
Propane	% mole		6
Butane	% mole		4
HC of C ₃ +C ₄	% mole		8
HC of C ₅ or more	% mole		0.1
Other gases (H ₂ +O ₂ +N ₂ +CO+CO ₂)	% mole		1.0
Sulphur content	mg/Nm ³		10
Wobbe Index	WI	13.260	13.730
Gross Calorific value	kcal/Nm ³	10.410	11.050
Maximum combustion speed	MCP	36.8	37.5

4.2.5. Hydrogen

Table A3/13

Hydrogen

<i>Characteristics</i>	<i>Units</i>	<i>Limits</i>		<i>Test method</i>
		<i>Minimum</i>	<i>Maximum</i>	
Hydrogen purity	% mole	98	100	ISO 14687-1
Total hydrocarbon	µmol/mol	0	100	ISO 14687-1
Water ^(a)	µmol/mol	0	(b)	ISO 14687-1
Oxygen	µmol/mol	0	(b)	ISO 14687-1
Argon	µmol/mol	0	(b)	ISO 14687-1
Nitrogen	µmol/mol	0	(b)	ISO 14687-1
CO	µmol/mol	0	1	ISO 14687-1
Sulphur	µmol/mol	0	2	ISO 14687-1
Permanent particulates ^(c)				ISO 14687-1

^(a) Not to be condensed.

^(b) Combined water, oxygen, nitrogen and argon: 1.900 µmol/mol.

^(c) The hydrogen shall not contain dust, sand, dirt, gums, oils, or other substances in an amount sufficient to damage the fuelling station equipment or the vehicle (engine) being fuelled.

5. Technical data on liquid fuels for testing vehicles with compression ignition engines
 - 5.1. J-Diesel (nominal 53 Cetane, B0)
 - 5.2. [Reserved]
 - 5.3. [Reserved]

5.4. Diesel

Table A3/17

Diesel

Parameter	Unit	Limits ^(a)		Test method (as applicable)
		Minimum	Maximum	
Cetane Index		46.0		EN-ISO 4264 JIS K2280
Cetane number ^(b)		52.0	56.0	EN-ISO 5165
Density at 15 °C	kg/m ³	833.0	837.0	EN-ISO 12185 JIS K2249
Distillation:				
— 50 % point	°C	245.0	—	EN-ISO 3405 JIS K2254
— 95 % point	°C	345.0	360.0	EN-ISO 3405 JIS K2254
— final boiling point	°C	—	370.0	EN-ISO 3405 JIS K2254
Flash point	°C	55	—	EN ISO 2719 JIS K2265-3
Cloud point	°C	—	-10	EN 116
Viscosity at 40 °C	mm ² /s	2.30	3.30	EN-ISO 3104 JIS K2283
Polycyclic aromatic hydrocarbons	% m/m	2.0	4.0	EN 12916 JIS method HPLC
Sulphur content	mg/kg	—	10.0	EN ISO 20846/ EN ISO 20884 JIS K2541-1 JIS K2541-2 JIS K2541-6 JIS K2541-7
Copper corrosion (3 hours, 50 °C)		—	Class 1	EN-ISO 2160
Conradson carbon residue (10 % DR)	% m/m	—	0.20	EN-ISO10370
Ash content	% m/m	—	0.010	EN-ISO 6245
Total contamination	mg/kg		24	EN 12662
Water content	mg/kg	—	200	EN-ISO12937
Acid number	mg KOH/g	—	0.10	EN ISO 6618
Lubricity (HFRR wear scan diameter at 60 °C)	µm	—	400	EN ISO 12156
Oxidation stability at 110 °C ^(c)	h	20.0		EN 15751
FAME ^(d)	% v/v	4.5	5.0	EN 14078

^(a) The values quoted in the specifications are 'true values'. In establishing of their limit values the terms of ISO 4259 Petroleum products – Determination and application of precision data in relation to methods of test have been applied and in fixing a minimum value, a minimum difference of 2R above zero has been taken into account; in fixing a maximum and minimum value, the minimum difference is 4R (R = reproducibility).

Notwithstanding this measure, which is necessary for technical reasons, the manufacturer of fuels shall nevertheless aim at a zero value where the stipulated maximum value is 2R and at the mean value in the case of quotations of maximum and minimum limits. Should it be necessary to clarify whether a fuel meets the requirements of the specifications, the terms of ISO 4259 shall be applied.

- (b) The range for cetane number is not in accordance with the requirements of a minimum range of 4R. However, in the case of a dispute between fuel supplier and fuel user, the terms of ISO 4259 may be used to resolve such disputes provided replicate measurements, of sufficient number to archive the necessary precision, are made in preference to single determinations.
- (c) Even though oxidation stability is controlled, it is likely that shelf life will be limited. Advice shall be sought from the supplier as to storage conditions and life.
- (d) FAME content to meet the specification of EN 14214.

6. Technical data on fuels for testing fuel cell vehicles

6.1. Compressed hydrogen gas for fuel cell vehicles

Table A3/18

Hydrogen for fuel cell vehicles

Characteristics	Units	Limits		Test Method
		Minimum	Maximum	
Hydrogen fuel index ^(a)	% mole	99.97		
Total non-hydrogen gases	µmol/mol		300	
Maximum concentration of individual contaminants^(f)				
Water (H ₂ O)	µmol/mol		5	e
Total hydrocarbons ^(b) (Methane basis)	µmol/mol		2	e
Oxygen (O ₂)	µmol/mol		5	e
Helium (He)	µmol/mol		300	e
Total Nitrogen (N ₂) and Argon (Ar) ^(b)	µmol/mol		100	e
Carbon dioxide (CO ₂)	µmol/mol		2	e
Carbon monoxide (CO)	µmol/mol		0.2	e
Total sulfur compounds ^(c) (H ₂ S basis)	µmol/mol		0.004	e
Formaldehyde (HCHO)	µmol/mol		0.01	e
Formic acid (HCOOH)	µmol/mol		0.2	e
Ammonia (NH ₃)	µmol/mol		0.1	e
Total halogenated compounds ^(d) (Halogenate ion basis)	µmol/mol		0.05	e

For the constituents that are additive, such as total hydrocarbons and total sulfur compounds, the sum of the constituents are to be less than or equal to the acceptable limit.

(a) The hydrogen fuel index is determined by subtracting the “total non-hydrogen gases” in this table, expressed in mole per cent, from 100 mole per cent.

(b) Total hydrocarbons include oxygenated organic species. Total hydrocarbons shall be measured on a carbon basis (µmolC/mol). Total hydrocarbons may exceed 2 µmol/mol due only to the presence of methane, in which case the summation of methane, nitrogen and argon shall not exceed 100 µmol/mol.

(c) As a minimum, total sulphur compounds include H₂S, COS, CS₂ and mercaptans, which are typically found in natural gas.

(d) Total halogenated compounds include, for example, hydrogen bromide (HBr), hydrogen chloride (HCl), chlorine (Cl₂), and organic halides (R-X).

(e) Test method shall be documented.

(f) The analysis of specific contaminants depending on the production process shall be exempted. A vehicle manufacturer shall provide the responsible authority reasons for exempting specific contaminants.

7. Technical data on fuels for Type 4 test on evaporative emissions

Table A3/19

Petrol reference fuel for Type 4 test

<i>Parameter</i>	<i>Unit</i>	<i>Limits</i>		<i>Test method</i>
		<i>Minimum</i>	<i>Maximum</i>	
Research octane number, RON		95.0	98.0	EN ISO 5164 JIS K2280
Density at 15 °C	kg/m ³	743.0	756.0	EN ISO 12185 JIS K2249-1,2,3
Vapour pressure	kPa	56.0	60.0	EN 13016-1 JIS K2258-1,2
Distillation:				
– evaporated at 70 °C	% v/v	34.0	46.0	EN ISO 3405
– evaporated at 100 °C	% v/v	54.0	62.0	EN ISO 3405
– evaporated at 150 °C	% v/v	86.0	94.0	EN ISO 3405
Hydrocarbon analysis:				
– olefins	% v/v	6.0	13.0	EN 22854
– aromatics	% v/v	25.0	32.0	EN 22854
– benzene	% v/v	-	1.00	EN 22854 EN 238 JIS K2536-2,3,4
Oxygen content	% m/m	3.3	3.7	EN 22854 JIS K2536-2,4,6
Sulphur content	mg/kg	—	10	EN ISO 20846 EN ISO 20884 JIS K2541-1,2,6,7
Lead content	mg/l	Not detected		EN 237 JIS K2255
Ethanol	% v/v	9.0	10.0	EN 22854 JIS K2536-2,4,6
MTBE		Not detected		JIS K2536-2,4,5,6 ^a
Methanol		Not detected		JIS K2536-2,4,5,6 ^a
Kerosene		Not detected		JIS K2536-2,4 ^(a)

^a Other method that is traceable to national or international standard may be used.

Annex B4

Road load and dynamometer setting

1. Scope

This annex describes the determination of the road load of a test vehicle and the transfer of that road load to a chassis dynamometer.
2. Terms and definitions
 - 2.1. For the purpose of this document, the terms and definitions given in paragraph 3. of this Regulation shall have primacy. Where definitions are not provided in paragraph 3. of this Regulation, definitions given in ISO 3833:1977 "Road vehicles -- Types -- Terms and definitions" shall apply.
 - 2.2. Reference speed points shall start at 20 km/h in incremental steps of 10 km/h and with the highest reference speed according to the following provisions:
 - (a) The highest reference speed point shall be 130 km/h or the reference speed point immediately above the maximum speed of the applicable test cycle if this value is less than 130 km/h. In the case that the applicable test cycle contains less than the 4 cycle phases (Low, Medium, High and Extra High) and at the request of the manufacturer and with approval of the responsible authority, the highest reference speed may be increased to the reference speed point immediately above the maximum speed of the next higher phase, but no higher than 130 km/h; in this case road load determination and chassis dynamometer setting shall be done with the same reference speed points;
 - (b) If a reference speed point applicable for the cycle plus 14 km/h is more than or equal to the maximum vehicle speed v_{max} , this reference speed point shall be excluded from the coastdown test and from chassis dynamometer setting. The next lower reference speed point shall become the highest reference speed point for the vehicle.
 - 2.3. Unless otherwise specified, a cycle energy demand shall be calculated according to paragraph 5. of Annex B7 over the target speed trace of the applicable drive cycle.
 - 2.4. f_0 , f_1 , f_2 are the road load coefficients of the road load equation $F = f_0 + f_1 \times v + f_2 \times v^2$ determined according to this annex.

f_0 is the constant road load coefficient and shall be rounded according to paragraph 6.1.8. of this Regulation to one place of decimal, N;

f_1 is the first order road load coefficient and shall be rounded according to paragraph 6.1.8. of this Regulation to three places of decimal, N/(km/h);

f_2 is the second order road load coefficient and shall be rounded according to paragraph 6.1.8. of this Regulation to five places of decimal, N/(km/h)².

Unless otherwise stated, the road load coefficients shall be calculated with a least square regression analysis over the range of the reference speed points.
 - 2.5. Rotational mass
 - 2.5.1. Determination of m_r

m_r is the equivalent effective mass of all the wheels and vehicle components rotating with the wheels on the road while the gearbox is placed in neutral, in kilograms (kg). m_r shall be measured or calculated using an appropriate technique agreed upon by the responsible authority. Alternatively, m_r may be estimated to be 3 per cent of the sum of the mass in running order and 25 kg.

- 2.5.2. Application of rotational mass to the road load
- Coastdown times shall be transferred to forces and vice versa by taking into account the applicable test mass plus m_r . This shall apply to measurements on the road as well as on a chassis dynamometer.
- 2.5.3. Application of rotational mass for the inertia setting
- If the vehicle is tested on a dynamometer in 4WD operation, the equivalent inertia mass of the chassis dynamometer shall be set to the applicable test mass.
- Otherwise, the equivalent inertia mass of the chassis dynamometer shall be set to the test mass plus either the equivalent effective mass of the wheels not influencing the measurement results or 50 per cent of m_r .
- 2.6. Additional masses for setting the test mass shall be applied such that the weight distribution of that vehicle is approximately the same as that of the vehicle with its mass in running order. In the case of Category N vehicles or passenger vehicles derived from Category N vehicles, the additional masses shall be located in a representative manner and shall be justified to the responsible authority upon their request. The weight distribution of the vehicle shall be recorded and shall be used for any subsequent road load determination testing.
3. General requirements
- The manufacturer shall be responsible for the accuracy of the road load coefficients and shall ensure this for each production vehicle within the road load family. Tolerances within the road load determination, simulation and calculation methods shall not be used to underestimate the road load of production vehicles. At the request of the responsible authority, the accuracy of the road load coefficients of an individual vehicle shall be demonstrated.
- 3.1. Overall measurement accuracy, precision, resolution and frequency
- The required overall measurement accuracy shall be as follows:
- (a) Vehicle speed accuracy: ± 0.2 km/h with a measurement frequency of at least 10 Hz;
 - (b) Time: min. accuracy: ± 10 ms; min. precision and resolution: 10 ms;
 - (c) Wheel torque accuracy: ± 6 Nm or ± 0.5 per cent of the maximum measured total torque, whichever is greater, for the whole vehicle, with a measurement frequency of at least 10 Hz;
 - (d) Wind speed accuracy: ± 0.3 m/s, with a measurement frequency of at least 1 Hz;
 - (e) Wind direction accuracy: $\pm 3^\circ$, with a measurement frequency of at least 1 Hz;
 - (f) Atmospheric temperature accuracy: ± 1 °C, with a measurement frequency of at least 0.1 Hz;
 - (g) Atmospheric pressure accuracy: ± 0.3 kPa, with a measurement frequency of at least 0.1 Hz;
 - (h) Vehicle mass accuracy measured on the same weighing scale before and after the test: ± 10 kg (± 20 kg for vehicles $> 4,000$ kg);
 - (i) Tyre pressure accuracy: ± 5 kPa;
 - (j) Wheel rotational speed accuracy: ± 0.05 s⁻¹ or 1 per cent, whichever is greater.

3.2. Wind tunnel criteria

3.2.1. Wind velocity

The wind velocity during a measurement shall remain within ± 2 km/h at the centre of the test section. The possible wind velocity shall be at least 140 km/h.

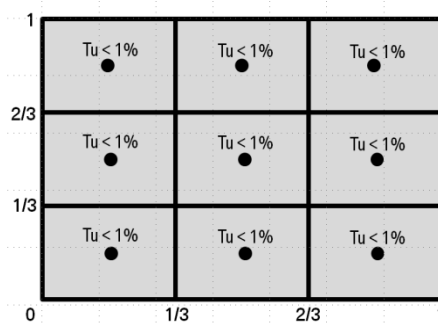
3.2.2. Air temperature

The air temperature during a measurement shall remain within ± 3 °C at the centre of the test section. The air temperature distribution at the nozzle outlet shall remain within ± 3 °C.

3.2.3. Turbulence

For an equally-spaced 3 by 3 grid over the entire nozzle outlet, the turbulence intensity, Tu , shall not exceed 1 per cent. See Figure A4/1.

Figure A4/1

Turbulence intensity

$$Tu = \frac{u'}{U_{\infty}}$$

where:

Tu is the turbulence intensity;

u' is the turbulent velocity fluctuation, m/s;

U_{∞} is the free flow velocity, m/s.

3.2.4. Solid blockage ratio

The vehicle blockage ratio ε_{sb} expressed as the quotient of the vehicle frontal area and the area of the nozzle outlet as calculated using the following equation, shall not exceed 0.35.

$$\varepsilon_{sb} = \frac{A_f}{A_{nozzle}}$$

where:

ε_{sb} is the vehicle blockage ratio;

A_f is the frontal area of the vehicle, m²;

A_{nozzle} is the nozzle outlet area, m².

3.2.5. Rotating wheels

To properly determine the aerodynamic influence of the wheels, the wheels of the test vehicle shall rotate at such a speed that the resulting vehicle velocity is within ± 3 km/h of the wind velocity.

3.2.6. Moving belt

To simulate the fluid flow at the underbody of the test vehicle, the wind tunnel shall have a moving belt extending from the front to the rear of the vehicle. The speed of the moving belt shall be within ± 3 km/h of the wind velocity.

3.2.7. Fluid flow angle

At nine equally distributed points over the nozzle area, the root mean square deviation of both the pitch angle α and the yaw angle β (Y-, Z-plane) at the nozzle outlet shall not exceed 1° .

3.2.8. Air pressure

At nine equally distributed points over the nozzle outlet area, the standard deviation of the total pressure at the nozzle outlet shall be less than or equal to 0.02.

$$\sigma\left(\frac{\Delta P_t}{q}\right) \leq 0.02$$

where:

σ is the standard deviation of the pressure ratio $\left(\frac{\Delta P_t}{q}\right)$;

ΔP_t is the variation of total pressure between the measurement points, N/m²;

q is the dynamic pressure, N/ m².

The absolute difference of the pressure coefficient c_p over a distance 3 metres ahead and 3 metres behind the centre of the balance in the empty test section and at a height of the centre of the nozzle outlet shall not deviate more than ± 0.02 .

$$|c_{p_{x=+3m}} - c_{p_{x=-3m}}| \leq 0.02$$

where:

c_p is the pressure coefficient.

3.2.9. Boundary layer thickness

At $x = 0$ (balance center point), the wind velocity shall have at least 99 per cent of the inflow velocity 30 mm above the wind tunnel floor.

$$\delta_{99}(x = 0 \text{ m}) \leq 30 \text{ mm}$$

where:

δ_{99} is the distance perpendicular to the road where 99 per cent of free stream velocity is reached (boundary layer thickness).

3.2.10. Restraint blockage ratio

The restraint system mounting shall not be in front of the vehicle. The relative blockage ratio of the vehicle frontal area due to the restraint system, ϵ_{restr} , shall not exceed 0.10.

$$\epsilon_{\text{restr}} = \frac{A_{\text{restr}}}{A_f} \text{ where:}$$

ϵ_{restr} is the relative blockage ratio of the restraint system;

A_{restr} is the frontal area of the restraint system projected on the nozzle face, m²;

A_f is the frontal area of the vehicle, m².

3.2.11. Measurement accuracy of the balance in the x-direction

The inaccuracy of the resulting force in the x-direction shall not exceed ± 5 N. The resolution of the measured force shall be within ± 3 N.

3.2.12. Measurement precision

The precision of the measured force shall be within ± 3 N.

4. Road load measurement on road
- 4.1. Requirements for road test
- 4.1.1. Atmospheric conditions for road test
- Atmospheric conditions (wind conditions, atmospheric temperature and atmospheric pressure) shall be measured according to paragraph 3.1. of this annex. Only those atmospheric conditions measured during coastdown time measurements and/or torque measurement shall be used for checking data validity and corrections.
- 4.1.1.1. Permissible wind conditions when using stationary anemometry and on-board anemometry
- 4.1.1.1.1. Permissible wind conditions when using stationary anemometry
- The wind speed shall be measured at a location and height above the road level alongside the test road where the most representative wind conditions will be experienced. In cases where tests in opposite directions cannot be performed at the same part of the test track (e.g. on an oval test track with an obligatory driving direction), the wind speed and direction shall be measured at the opposite parts of the test track.
- The wind conditions during run pairs shall meet all of the following criteria:
- (a) Wind speed shall be less than 5 m/s over a 5 second moving average period;
 - (b) Peak wind speeds shall not exceed 8 m/s for more than 2 consecutive seconds;
 - (c) The arithmetic average vector component of the wind speed across the test road shall be less than 2 m/s.
- The wind correction shall be calculated according to paragraph 4.5.3. of this annex.
- 4.1.1.1.2. Permissible wind conditions when using on-board anemometry
- For testing with an on-board anemometer, a device as described in paragraph 4.3.2. of this annex shall be used.
- The wind conditions during run pairs shall meet all of the following criteria:
- (a) The arithmetic average of the wind speed shall be less than 7 m/s;
 - (b) Peak wind speeds shall not exceed 10 m/s for more than 2 consecutive seconds;
 - (c) The arithmetic average vector component of the wind speed across the road shall be less than 4 m/s.
- 4.1.1.2. Atmospheric temperature
- The atmospheric temperature should be within the range of 5 °C up to and including 40 °C.
- At the option of the manufacturer, coastdowns may be performed between 1 °C and 5 °C. If the difference between the highest and the lowest measured temperature during the coastdown test is more than 5 °C, the temperature correction shall be applied separately for each run with the arithmetic average of the ambient temperature of that run.
- In that case, the values of the road load coefficients f_0 , f_1 and f_2 shall be determined and corrected for each run pair. The final set of f_0 , f_1 and f_2 values shall be the arithmetic average of the individually corrected coefficients f_0 , f_1 and f_2 respectively.

4.1.2. Test road

The road surface shall be flat, even, clean, dry and free of obstacles or wind barriers that might impede the measurement of the road load, and its texture and composition shall be representative of current urban and highway road surfaces, i.e. no airstrip-specific surface. The longitudinal slope of the test road shall not exceed ± 1 per cent. The local slope between any points 3 metres apart shall not deviate more than ± 0.5 per cent from this longitudinal slope. If tests in opposite directions cannot be performed at the same part of the test track (e.g. on an oval test track with an obligatory driving direction), the sum of the longitudinal slopes of the parallel test track segments shall be between 0 and an upward slope of 0.1 per cent. The maximum camber of the test road shall be 1.5 per cent.

4.2. Preparation

4.2.1. Test vehicle

Each test vehicle shall conform in all its components with the production series, (e.g. side mirrors shall be same position as during normal vehicle operation, body gaps shall not be sealed), or, if the vehicle is different from the production vehicle, a full description shall be recorded.

4.2.1.1. Requirements for test vehicle selection

4.2.1.1.1. Without using the interpolation method

A test vehicle (vehicle H) with the combination of road load relevant characteristics (i.e. mass, aerodynamic drag and tyre rolling resistance) producing the highest cycle energy demand shall be selected from the family (see paragraphs 6.3.2. and 6.3.3. of this Regulation).

If the aerodynamic influence of the different wheels within one interpolation family is not known, the selection shall be based on the highest expected aerodynamic drag. As a guideline, the highest aerodynamic drag may be expected for wheels with (a) the largest width, (b) the largest diameter, and (c) the most open structure design (in that order of importance).

The wheel selection shall be performed additional to the requirement of the highest cycle energy demand.

4.2.1.1.2. Using an interpolation method

At the request of the manufacturer, an interpolation method may be applied.

In this case, two test vehicles shall be selected from the family complying with the respective family requirement.

Test vehicle H shall be the vehicle producing the higher, and preferably highest, cycle energy demand of that selection, test vehicle L the one producing the lower, and preferably lowest, cycle energy demand of that selection.

All items of optional equipment and/or body shapes that are chosen not to be considered when applying the interpolation method shall be identical for both test vehicles H and L such that these items of optional equipment produce the highest combination of the cycle energy demand due to their road load relevant characteristics (i.e. mass, aerodynamic drag and tyre rolling resistance).

In the case where individual vehicles can be supplied with a complete set of standard wheels and tyres and in addition a complete set of snow tyres (marked with 3 Peaked Mountain and Snowflake – 3PMS) with or without wheels, the additional wheels/tyres shall not be considered as optional equipment.

4.2.1.1.2.1. The following requirements between vehicles H and L shall be fulfilled for the road load relevant characteristics:

- (a) To allow extrapolating road load coefficients:
- (i) If f_{0_ind} is below $f_{0_L}^*$ or above f_{0_H} as defined in paragraph 3.2.3.2.2.4. while performing the calculation in paragraph 3.2.3.2.2.4. of Annex B7, the following minimum differences between H and L are required:
- Rolling resistance of at least 1.0 kg/tonne and a mass of at least 30 kg; in case of RR between 0 and 1.0, the minimum of the mass difference is replaced with 100 kg instead of 30 kg;
- (ii) If f_{2_ind} is below $f_{2_L}^*$ or above f_{2_H} as defined in paragraph 3.2.3.2.2.4. while performing the calculation in paragraph 3.2.3.2.2.4. of Annex B7, the following minimum difference between H and L is required:
- Aerodynamic drag ($C_D \times A_f$) of at least 0.05 m². If the manufacturer can demonstrate that the results after an extrapolation are still rational, the minimum criteria in points (i) to (iii) above can be waived.
- (b) For each road load characteristic (i.e. mass, aerodynamic drag and tyre rolling resistance) as well as for the road load coefficients f_0 and f_2 , the value of vehicle H shall be higher than that of vehicle L, otherwise the worst case shall be applied for that road load relevant characteristic. At the request of the manufacturer and upon approval by the responsible authority the requirements of this point can be waived.
- 4.2.1.1.2.2. To achieve a sufficient difference between vehicle H and vehicle L on a particular road load relevant characteristic, or in order to fulfil criteria of paragraph 4.2.1.1.2.1. of this annex, the manufacturer may artificially worsen vehicle H, e.g. by applying a higher test mass.
- 4.2.1.2. Requirements for families
- 4.2.1.2.1. Requirements for applying the interpolation family without using the interpolation method
- For the criteria defining an interpolation family, see paragraph 6.2. of this Regulation.
- 4.2.1.2.2. Requirements for applying the interpolation family using the interpolation method are:
- (a) Fulfilling the interpolation family criteria listed in paragraph 6.2. of this Regulation;
- (b) Fulfilling the requirements in paragraphs 2.3.1. and 2.3.2. of Annex B6;
- (c) Performing the calculations in paragraph 3.2.3.2. of Annex B7.
- 4.2.1.2.3. Requirements for applying the road load family
- 4.2.1.2.3.1. At the request of the manufacturer and upon fulfilling the criteria of paragraph 6.3. of this Regulation, the road load values for vehicles H and L of an interpolation family shall be calculated.
- 4.2.1.2.3.2. Test vehicles H and L as defined in paragraph 4.2.1.1.2. of this annex shall be referred to as H_R and L_R for the purpose of the road load family.
- 4.2.1.2.3.3. The difference in cycle energy demand between H_R and L_R of the road load family shall be at least 4 per cent and shall not exceed 35 per cent based on H_R over a complete WLTC Class 3 cycle.
- If more than one transmission is included in the road load family, a transmission with the highest power losses shall be used for road load determination.

4.2.1.2.3.4. If the road load delta of the vehicle option causing the friction difference is determined according to paragraph 6.8. of this annex, a new road load family shall be calculated which includes the road load delta in both vehicle L and vehicle H of that new road load family.

$$f_{0,N} = f_{0,R} + f_{0,\Delta}$$

$$f_{1,N} = f_{1,R} + f_{1,\Delta}$$

$$f_{2,N} = f_{2,R} + f_{2,\Delta}$$

where:

N refers to the road load coefficients of the new road load family;

R refers to the road load coefficients of the reference road load family;

Delta refers to the delta road load coefficients determined in paragraph 6.8.1. of this annex.

4.2.1.3. Allowable combinations of test vehicle selection and family requirements

Table A4/1 shows the permissible combinations of test vehicle selection and family requirements as described in paragraphs 4.2.1.1. and 4.2.1.2. of this annex.

Table A4/1

Permissible combinations of test vehicle selection and family requirements

<i>Requirements to be fulfilled:</i>	<i>(1) w/o interpolation method</i>	<i>(2) Interpolation method w/o road load family</i>	<i>(3) Applying the road load family</i>	<i>(4) Interpolation method using one or more road load families</i>
Road load test vehicle	Paragraph 4.2.1.1.1. of this annex.	Paragraph 4.2.1.1.2. of this annex.	Paragraph 4.2.1.1.2. of this annex.	n.a.
Family	Paragraph 4.2.1.2.1. of this annex.	Paragraph 4.2.1.2.2. of this annex.	Paragraph 4.2.1.2.3. of this annex.	Paragraph 4.2.1.2.2. of this annex.
Additional	none	none	none	Application of column (3) "Applying the road load family" and application of paragraph 4.2.1.3.1. of this annex.

4.2.1.3.1. Deriving road loads of an interpolation family from a road load family

Road loads H_R and/or L_R shall be determined according to this annex.

The road load of vehicle H (and L) of an interpolation family within the road load family shall be calculated according to paragraphs 3.2.3.2.2. to 3.2.3.2.2.4. inclusive of Annex B7 by:

- (a) Using H_R and L_R of the road load family instead of H and L as inputs for the equations;
- (b) Using the road load parameters (i.e. test mass, $\Delta(C_D \times A_f)$ compared to vehicle L_R , and tyre rolling resistance) of vehicle H (or L) of the interpolation family as inputs for the individual vehicle;
- (c) Repeating this calculation for each H and L vehicle of every interpolation family within the road load family.

The road load interpolation shall only be applied on those road load-relevant characteristics that were identified to be different between test vehicle L_R and H_R . For other road load-relevant characteristic(s), the value of vehicle H_R shall apply.

H and L of the interpolation family may be derived from different road load families. If that difference between these road load families comes from applying the delta method, refer to paragraph 4.2.1.2.3.4. of this annex.

4.2.1.4. Application of the road load matrix family

A vehicle that fulfils the criteria of paragraph 6.3.4. of this Regulation that is:

- (a) Representative of the intended series of complete vehicles to be covered by the road load matrix family in terms of estimated worst C_D value and body shape; and
- (b) Representative of the intended series of vehicles to be covered by the road load matrix family in terms of estimated average of the mass of optional equipment

shall be used to determine the road load.

In the case that no representative body shape for a complete vehicle can be determined, the test vehicle shall be equipped with a square box with rounded corners with radii of maximum of 25 mm and a width equal to the maximum width of the vehicles covered by the road load matrix family, and a total height of the test vehicle of 3.0 m \pm 0.1 m, including the box.

The manufacturer and the responsible authority shall agree which vehicle test model is representative.

The vehicle parameters test mass, tyre rolling resistance and frontal area of both a vehicle H_M and L_M shall be determined in such a way that vehicle H_M produces the highest cycle energy demand and vehicle L_M the lowest cycle energy from the road load matrix family. The manufacturer and the responsible authority shall agree on the vehicle parameters for vehicles H_M and L_M .

The road load of all individual vehicles of the road load matrix family, including H_M and L_M , shall be calculated according to paragraph 5.1. of this annex.

4.2.1.5. Movable aerodynamic body parts

Movable aerodynamic body parts on the test vehicles shall operate during road load determination as intended under WLTP Type 1 test conditions (test temperature, vehicle speed and acceleration range, engine load, etc.).

Every vehicle system that dynamically modifies the vehicle's aerodynamic drag (e.g. vehicle height control) shall be considered to be a movable aerodynamic body part. Appropriate requirements shall be added if future vehicles are equipped with movable aerodynamic items of optional equipment whose influence on aerodynamic drag justifies the need for further requirements.

4.2.1.6. Weighing

Before and after the road load determination procedure, the selected vehicle shall be weighed, including the test driver and equipment, to determine the arithmetic average mass m_{av} . The mass of the vehicle shall be greater than or equal to the test mass of vehicle H or of vehicle L at the start of the road load determination procedure.

4.2.1.7. Test vehicle configuration

The test vehicle configuration shall be recorded and shall be used for any subsequent coastdown testing.

4.2.1.8. Test vehicle condition

4.2.1.8.1. Run-in

The test vehicle shall be suitably run-in for the purpose of the subsequent test for at least 10,000 but no more than 80,000 km.

At the request of the manufacturer, a vehicle with a minimum of 3,000 km may be used.

4.2.1.8.2. Manufacturer's specifications

The vehicle shall conform to the manufacturer's intended production vehicle specifications regarding tyre pressures described in paragraph 4.2.2.3. of this annex, wheel alignment described in paragraph 4.2.1.8.3. of this annex, ground clearance, vehicle height, drivetrain and wheel bearing lubricants, and brake adjustment to avoid unrepresentative parasitic drag.

4.2.1.8.3. Wheel alignment

Toe and camber shall be set to the maximum deviation from the longitudinal axis of the vehicle in the range defined by the manufacturer. If a manufacturer prescribes values for toe and camber for the vehicle, these values shall be used. At the request of the manufacturer, values with higher deviations from the longitudinal axis of the vehicle than the prescribed values may be used. The prescribed values shall be the reference for all maintenance during the lifetime of the vehicle.

Other adjustable wheel alignment parameters (such as caster) shall be set to the values recommended by the manufacturer. In the absence of recommended values, they shall be set to the arithmetic average of the range defined by the manufacturer.

Such adjustable parameters and set values shall be recorded.

4.2.1.8.4. Closed panels

During the road load determination, the engine compartment cover, luggage compartment cover, manually-operated movable panels and all windows shall be closed.

4.2.1.8.5. Vehicle coastdown mode

If the determination of dynamometer settings cannot meet the criteria described in paragraphs 8.1.3. or 8.2.3. of this annex due to non-reproducible forces, the vehicle shall be equipped with a vehicle coastdown mode. The vehicle coastdown mode shall be approved and its use shall be recorded by the responsible authority.

If a vehicle is equipped with a vehicle coastdown mode, it shall be engaged both during road load determination and on the chassis dynamometer.

4.2.2. Tyres

4.2.2.1. Tyre rolling resistance

Tyre rolling resistances shall be measured according to Annex 6 to UN Regulation No. 117 - 02, or an internationally-accepted equivalent. The rolling resistance coefficients shall be aligned according to the respective regional procedures (e.g. EU 1235/2011), and categorised according to the rolling resistance classes in Table A4/2.

Table A4/2

Energy efficiency classes according to rolling resistance coefficients (RRC) for C1, C2 and C3 tyres and the RRC values to be used for those energy efficiency classes in the interpolation, kg/tonne

<i>Energy efficiency class</i>	<i>Range of RRC for C1 tyres</i>	<i>Range of RRC for C2 tyres</i>	<i>Range of RRC for C3 tyres</i>
1	RRC ≤ 6.5	RRC ≤ 5.5	RRC ≤ 4.0
2	6.5 < RRC ≤ 7.7	5.5 < RRC ≤ 6.7	4.0 < RRC ≤ 5.0
3	7.7 < RRC ≤ 9.0	6.7 < RRC ≤ 8.0	5.0 < RRC ≤ 6.0
4	9.0 < RRC ≤ 10.5	8.0 < RRC ≤ 9.2	6.0 < RRC ≤ 7.0
5	10.5 < RRC ≤ 12.0	9.2 < RRC ≤ 10.5	7.0 < RRC ≤ 8.0
6	RRC > 12.0	RRC > 10.5	RRC > 8.0

<i>Energy efficiency class</i>	<i>Value of RRC to be used for interpolation for C1 tyres</i>	<i>Value of RRC to be used for interpolation for C2 tyres</i>	<i>Value of RRC to be used for interpolation for C3 tyres</i>
1	RRC = 5.9	RRC = 4.9	RRC = 3.5
2	RRC = 7.1	RRC = 6.1	RRC = 4.5
3	RRC = 8.4	RRC = 7.4	RRC = 5.5
4	RRC = 9.8	RRC = 8.6	RRC = 6.5
5	RRC = 11.3	RRC = 9.9	RRC = 7.5
6	RRC = 12.9	RRC = 11.2	RRC = 8.5

If the interpolation method is applied to rolling resistance the actual rolling resistance values for the tyres fitted to the test vehicles L and H shall be used as input for the interpolation method. For an individual vehicle within an interpolation family, the RRC value for the energy efficiency class of the tyres fitted shall be used.

In the case where individual vehicles can be supplied with a complete set of standard wheels and tyres and in addition a complete set of snow tyres (marked with 3 Peaked Mountain and Snowflake – 3PMS) with or without wheels, the additional wheels/tyres shall not be considered as optional equipment.

4.2.2.2. Tyre condition

Tyres used for the test shall:

- (a) Not be older than 2 years after the production date;
- (b) Not be specially conditioned or treated (e.g. heated or artificially aged), with the exception of grinding in the original shape of the tread;
- (c) Be run-in on a road for at least 200 km before road load determination;
- (d) Have a constant tread depth before the test between 100 and 80 per cent of the original tread depth at any point over the full tread width of the tyre.

After measurement of tread depth, the driving distance shall be limited to 500 km. If 500 km are exceeded, the tread depth shall be measured again.

4.2.2.3. Tyre pressure

The front and rear tyres shall be inflated to the lower limit of the tyre pressure range for the respective axle for the selected tyre at the coastdown test mass, as specified by the vehicle manufacturer.

4.2.2.3.1. Tyre pressure adjustment

If the difference between ambient and soak temperature is more than 5 °C, the tyre pressure shall be adjusted as follows:

- (a) The tyres shall be soaked for more than 1 hour at 10 per cent above the target pressure;
- (b) Prior to testing, the tyre pressure shall be reduced to the inflation pressure as specified in paragraph 4.2.2.3. of this annex, adjusted for difference between the soaking environment temperature and the ambient test temperature at a rate of 0.8 kPa per 1 °C using the following equation:

$$\Delta p_t = 0.8 \times (T_{\text{soak}} - T_{\text{amb}})$$

where:

Δp_t is the tyre pressure adjustment added to the tyre pressure defined in paragraph 4.2.2.3. of this annex, kPa;

0.8 is the pressure adjustment factor, kPa/°C;

T_{soak} is the tyre soaking temperature, °C;

T_{amb} is the test ambient temperature, °C.

- (c) Between the pressure adjustment and the vehicle warm-up, the tyres shall be shielded from external heat sources including sun radiation.

4.2.3. Instrumentation

Any instruments shall be installed in such a manner as to minimise their effects on the aerodynamic characteristics of the vehicle.

If the effect of the installed instrument on $(C_D \times A_f)$ is expected to be greater than 0.015 m², the vehicle with and without the instrument shall be measured in a wind tunnel fulfilling the criteria in paragraph 3.2. of this annex. The corresponding difference shall be subtracted from f_2 . At the request of the manufacturer, and with approval of the responsible authority, the determined value may be used for similar vehicles where the influence of the equipment is expected to be the same.

4.2.4. Vehicle warm-up

4.2.4.1. On the road

Warming up shall be performed by driving the vehicle only.

- 4.2.4.1.1. Before warm-up, the vehicle shall be decelerated with the clutch disengaged or an automatic transmission placed in neutral by moderate braking from 80 to 20 km/h within 5 to 10 seconds. After this braking, there shall be no further actuation or manual adjustment of the braking system.

At the request of the manufacturer and upon approval of the responsible authority, the brakes may also be activated after the warm-up with the same deceleration as described in this paragraph and only if necessary.

4.2.4.1.2. Warming up and stabilization

All vehicles shall be driven at 90 per cent of the maximum speed of the applicable WLTC. The vehicle may be driven at 90 per cent of the maximum speed of the next higher phase (see Table A4/3) if this phase is added to the applicable WLTC warm-up procedure as defined in paragraph 7.3.4. of this annex. The vehicle shall be warmed up for at least 20 minutes until stable conditions are reached.

Table A4/3

Warming-up and stabilization across phases (as applicable)

<i>Cycle class</i>	<i>Applicable WLTC</i>	<i>90 per cent of maximum speed</i>	<i>Next higher phase</i>
Class 1	Low ₁ + Medium ₁	58 km/h	NA
Class 2	Low ₂ + Medium ₂ + High ₂ + Extra High ₂	111 km/h	NA
	Low ₂ + Medium ₂ + High ₂	77 km/h	Extra High (111 km/h)
Class 3	Low ₃ + Medium ₃ + High ₃ + Extra High ₃	118 km/h	NA
	Low ₃ + Medium ₃ + High ₃	88 km/h	Extra High (118 km/h)

4.2.4.1.3. Criterion for stable condition

Refer to paragraph 4.3.1.4.2. of this annex.

4.3. Measurement and calculation of road load using the coastdown method

The road load shall be determined by using either the stationary anemometry (paragraph 4.3.1. of this annex) or the on-board anemometry (paragraph 4.3.2. of this annex) method.

4.3.1. Coastdown method using stationary anemometry

4.3.1.1. Selection of reference speeds for road load curve determination

Reference speeds for road load determination shall be selected according to paragraph 2.2. of this annex.

4.3.1.2. Data collection

During the test, elapsed time and vehicle speed shall be measured at a minimum frequency of 10 Hz.

4.3.1.3. Vehicle coastdown procedure

4.3.1.3.1. Following the vehicle warm-up procedure described in paragraph 4.2.4. of this annex and immediately prior to each coastdown run, the vehicle shall be accelerated to 10 to 15 km/h above the highest reference speed and shall be driven at that speed for a maximum of 1 minute. After that, the coastdown run shall be started immediately.

4.3.1.3.2. During a coastdown run, the transmission shall be in neutral. Any movement of the steering wheel shall be avoided as much as possible, and the vehicle brakes shall not be operated.

4.3.1.3.3. The test shall be repeated until the coastdown data satisfy the statistical precision requirements as specified in paragraph 4.3.1.4.2. of this annex.

4.3.1.3.4. Although it is recommended that each coastdown run should be performed without interruption, if data cannot be collected in a single run for all the reference speed points, the coastdown test may be performed with coastdown runs where the first and last reference speeds are not necessarily the highest and lowest reference speeds. In this case, the following additional requirements shall apply:

(a) At least one reference speed in each coastdown run shall overlap with the immediately higher speed range coastdown run. This reference speed shall be referred to as a split point;

(b) At each overlapped reference speed, the average force of the immediately lower speed coastdown run shall not deviate from the average force of the immediately higher speed coastdown run by ± 10 N or ± 5 per cent, whichever is greater;

- (c) Overlapped reference speed data of the lower speed coastdown run shall be used only for checking criterion (b) and shall be excluded from evaluation of the statistical precision as defined in paragraph 4.3.1.4.2. of this annex;
- (d) The overlapped speed may be less than 10 km/h but shall not be less than 5 km/h. In this case, overlap criterion (b) shall be checked by either extrapolating the polynomial curves for the lower and higher speed segment to a 10 km/h overlap, or by comparing the average force in the specific speed range.

4.3.1.3.5. It is recommended that coastdown runs should be conducted successively without undue delay between runs. If there is a delay between runs (e.g. for a driver break, checking vehicle integrity, etc.), the vehicle shall be warmed up again as described in paragraph 4.2.4. and the coastdown runs shall be recommenced from this point.

4.3.1.4. Coastdown time measurement

4.3.1.4.1. The coastdown time corresponding to reference speed v_j as the elapsed time from vehicle speed $(v_j + 5 \text{ km/h})$ to $(v_j - 5 \text{ km/h})$ shall be measured.

4.3.1.4.2. These measurements shall be carried out in opposite directions until a minimum of three pairs of measurements have been obtained that satisfy the statistical precision p_j defined in the following equation:

$$p_j = \frac{h \times \sigma_j}{\sqrt{n} \times \Delta t_{pj}} \leq 0.030$$

where:

p_j is the statistical precision of the measurements made at reference speed v_j ;

n is the number of pairs of measurements;

Δt_{pj} is the harmonic average of the coastdown time at reference speed v_j in seconds given by the following equation:

$$\Delta t_{pj} = \frac{n}{\sum_{i=1}^n \frac{1}{\Delta t_{ji}}}$$

where:

Δt_{ji} is the harmonic average coastdown time of the i^{th} pair of measurements at velocity v_j , seconds, s, given by the following equation:

$$\Delta t_{ji} = \frac{2}{\left(\frac{1}{\Delta t_{jai}}\right) + \left(\frac{1}{\Delta t_{jbi}}\right)}$$

where:

Δt_{jai} and Δt_{jbi} are the coastdown times of the i^{th} measurement at reference speed v_j , in seconds, s, in the respective directions a and b;

σ_j is the standard deviation, expressed in seconds, s, defined by:

$$\sigma_j = \sqrt{\frac{1}{n-1} \sum_{i=1}^n (\Delta t_{ji} - \Delta t_{pj})^2}$$

h is a coefficient given in Table A4/4.

Table A4/4
Coefficient h as a function of n

n	h	n	h
3	4.3	17	2.1
4	3.2	18	2.1
5	2.8	19	2.1
6	2.6	20	2.1
7	2.5	21	2.1
8	2.4	22	2.1
9	2.3	23	2.1
10	2.3	24	2.1
11	2.2	25	2.1
12	2.2	26	2.1
13	2.2	27	2.1
14	2.2	28	2.1
15	2.2	29	2.0
16	2.1	30	2.0

4.3.1.4.3. If during a measurement in one direction any external factor or driver action occurs that obviously influences the road load test, that measurement and the corresponding measurement in the opposite direction shall be rejected. All the rejected data and the reason for rejection shall be recorded, and the number of rejected pairs of measurement shall not exceed 1/3 of the total number of measurement pairs. In the case of split runs, the rejection criteria shall be applied at each split run speed range.

Due to uncertainty of data validity and for practical reasons, more than the minimum number of run pairs required in paragraph 4.3.1.4.2. of this annex may be performed, but the total number of run pairs shall not exceed 30 runs including the rejected pairs as described in this paragraph. In this case, data evaluation shall be carried out as described in paragraph 4.3.1.4.2. of this annex starting from the first run pair, then including as many consecutive run pairs as needed to reach the statistical precision on a data set containing no more than 1/3 of rejected pairs. The remaining run pairs shall be disregarded.

4.3.1.4.4. The following equation shall be used to compute the arithmetic average of the road load where the harmonic average of the alternate coastdown times shall be used:

$$F_j = \frac{1}{3.6} \times (m_{av} + m_r) \times \frac{2 \times \Delta v}{\Delta t_j}$$

where:

Δv is 5 km/h;

Δt_j is the harmonic average of alternate coastdown time measurements at velocity v_j , seconds, s, given by:

$$\Delta t_j = \frac{2}{\frac{1}{\Delta t_{ja}} + \frac{1}{\Delta t_{jb}}}$$

where:

Δt_{ja} and Δt_{jb} are the harmonic average coastdown times in directions a and b, respectively, corresponding to reference speed v_j , in seconds, s, given by the following two equations:

$$\Delta t_{ja} = \frac{n}{\sum_{i=1}^n \frac{1}{t_{jai}}}$$

and:

$$\Delta t_{jb} = \frac{n}{\sum_{i=1}^n \frac{1}{t_{jbi}}}$$

where:

m_{av} is the arithmetic average of the test vehicle masses at the beginning and end of road load determination, kg;

m_r is the equivalent effective mass of rotating components according to paragraph 2.5.1. of this annex;

The coefficients, f_0 , f_1 and f_2 , in the road load equation shall be calculated with a least squares regression analysis.

In the case that the tested vehicle is the representative vehicle of a road load matrix family, the coefficient f_1 shall be set to zero and the coefficients f_0 and f_2 shall be recalculated with a least squares regression analysis.

4.3.1.4.5 Correction to reference conditions

The curve determined in paragraph 4.3.1.4.4. of this annex shall be corrected to reference conditions as specified in paragraph 4.5. of this annex.

4.3.2. Coastdown method using on-board anemometry

The vehicle shall be warmed up and stabilised according to paragraph 4.2.4. of this annex.

4.3.2.1. Additional instrumentation for on-board anemometry

The on-board anemometer and instrumentation shall be calibrated by means of operation on the test vehicle where such calibration occurs during the warm-up for the test.

4.3.2.1.1. Relative wind speed shall be measured at a minimum frequency of 1 Hz and to an accuracy of 0.3 m/s. Vehicle blockage shall be accounted for in the calibration of the anemometer.

4.3.2.1.2. Wind direction shall be relative to the direction of the vehicle. The relative wind direction (yaw) shall be measured with a resolution of 1 degree and an accuracy of 3 degrees; the dead band of the instrument shall not exceed 10 degrees and shall be directed towards the rear of the vehicle.

4.3.2.1.3. Before the coastdown, the anemometer shall be calibrated for speed and yaw offset as specified in ISO 10521-1:2006(E) Annex A.

4.3.2.1.4. Anemometer blockage shall be corrected for in the calibration procedure as described in ISO 10521-1:2006(E) Annex A in order to minimise its effect.

4.3.2.2. Selection of vehicle speed range for road load curve determination

The test vehicle speed range shall be selected according to paragraph 2.2. of this annex.

4.3.2.3. Data collection

During the procedure, elapsed time, vehicle speed, and air velocity (speed, direction) relative to the vehicle, shall be measured at a minimum frequency of 5 Hz. Ambient temperature shall be synchronised and sampled at a minimum frequency of 0.1 Hz.

4.3.2.4. Vehicle coastdown procedure

The measurements shall be carried out in run pairs in opposite directions until a minimum of ten consecutive runs (five pairs) have been obtained. Should an individual run fail to satisfy the required on-board anemometry test conditions, that pair, i.e. that run and the corresponding run in the opposite direction, shall be rejected. All valid pairs shall be included in the final analysis with a minimum of 5 pairs of coastdown runs. See paragraph 4.3.2.6.10. of this annex for statistical validation criteria.

The anemometer shall be installed in a position such that the effect on the operating characteristics of the vehicle is minimised.

The anemometer shall be installed according to one of the options below:

- (a) Using a boom approximately 2 metres in front of the vehicle's forward aerodynamic stagnation point;
- (b) On the roof of the vehicle at its centreline. If possible, the anemometer shall be mounted within 30 cm from the top of the windshield;
- (c) On the engine compartment cover of the vehicle at its centreline, mounted at the midpoint position between the vehicle front and the base of the windshield.

In all cases, the anemometer shall be mounted parallel to the road surface. In the event that positions (b) or (c) are used, the coastdown results shall be analytically adjusted for the additional aerodynamic drag induced by the anemometer. The adjustment shall be made by testing the coastdown vehicle in a wind tunnel both with and without the anemometer installed in the same position as used on the track. The calculated difference shall be the incremental aerodynamic drag coefficient C_D combined with the frontal area, which shall be used to correct the coastdown results.

- 4.3.2.4.1. Following the vehicle warm-up procedure described in paragraph 4.2.4. of this annex and immediately prior to each coastdown run, the vehicle shall be accelerated to 10 to 15 km/h above the highest reference speed and shall be driven at that speed for a maximum of 1 minute. After that, the coastdown run shall be started immediately.
- 4.3.2.4.2. During a coastdown run, the transmission shall be in neutral. Any steering wheel movement shall be avoided as much as possible, and the vehicle's brakes shall not be operated.
- 4.3.2.4.3. Although it is recommended that each coastdown run be performed without interruption, if data cannot be collected in a single run for all the reference speed points the coastdown test may be performed with coastdown runs where the first and last reference speeds are not necessarily the highest and lowest reference speeds. For split runs, the following additional requirements shall apply:
 - (a) At least one reference speed in each coastdown run shall overlap with the immediately higher speed range coastdown run. This reference speed shall be referred to as a split point;
 - (b) At each overlapped reference speed, the average force of the immediately lower speed coastdown run shall not deviate from the average force of the immediately higher speed range coastdown run by ± 10 N or ± 5 per cent, whichever is greater;
 - (c) Overlapped reference speed data of the lower speed coastdown run shall be used only for checking criterion (b) and shall be excluded from evaluation of the statistical precision as defined in paragraph 4.3.1.4.2. of this annex;
 - (d) The overlapped speed may be less than 10 km/h but shall not be less than 5 km/h. In this case, overlap criterion (b) shall be checked by either extrapolating the polynomial curves for the lower and higher speed segment to a 10 km/h overlap, or by comparing the average force in the specific speed range.
- 4.3.2.4.4. It is recommended that coastdown runs should be conducted successively without undue delay between runs. If there is a delay between runs (e.g. for a driver break, checking vehicle integrity, etc.), the vehicle shall be warmed up again as described in paragraph 4.2.4. and the coastdown runs shall be recommenced from this point.

4.3.2.5. Determination of the equation of motion

Symbols used in the on-board anemometer equations of motion are listed in Table A4/5.

Table A4/5

Symbols used in the on-board anemometer equations of motion

<i>Symbol</i>	<i>Units</i>	<i>Description</i>
A_f	m^2	frontal area of the vehicle
$a_0 \dots a_n$	degrees ⁻¹	aerodynamic drag coefficients as a function of yaw angle
A_m	N	mechanical drag coefficient
B_m	N/(km/h)	mechanical drag coefficient
C_m	N/(km/h) ²	mechanical drag coefficient
$C_D(Y)$		aerodynamic drag coefficient at yaw angle Y
D	N	drag
D_{aero}	N	aerodynamic drag
D_f	N	front axle drag (including driveline)
D_{grav}	N	gravitational drag
D_{mech}	N	mechanical drag
D_r	N	rear axle drag (including driveline)
D_{tyre}	N	tyre rolling resistance
(dh/ds)	-	sine of the slope of the track in the direction of travel (+ indicates ascending)
(dv/dt)	m/s^2	acceleration
g	m/s^2	gravitational constant
m_{av}	kg	arithmetic average mass of the test vehicle before and after road load determination
m_e	kg	effective vehicle mass including rotating components
ρ	kg/m^3	air density
t	s	time
T	K	Temperature
v	km/h	vehicle speed
v_r	km/h	relative wind speed
Y	degrees	yaw angle of apparent wind relative to direction of vehicle travel

4.3.2.5.1. General form

The general form of the equation of motion is as follows:

$$-m_e \left(\frac{dv}{dt} \right) = D_{mech} + D_{aero} + D_{grav}$$

where:

$$D_{mech} = D_{tyre} + D_f + D_r;$$

$$D_{aero} = \left(\frac{1}{2} \right) \rho C_D(Y) A_f v_r^2;$$

$$D_{grav} = m \times g \times \left(\frac{dh}{ds} \right)$$

In the case that the slope of the test track is equal to or less than 0.1 per cent over its length, D_{grav} may be set to zero.

4.3.2.5.2. Mechanical drag modelling

Mechanical drag consisting of separate components representing tyre D_{tyre} and front and rear axle frictional losses D_f and D_r (including transmission losses) shall be modelled as a three-term polynomial as a function of vehicle speed v as in the equation below:

$$D_{\text{mech}} = A_m + B_m v + C_m v^2$$

where A_m , B_m , and C_m are determined in the data analysis using the least squares method. These constants reflect the combined driveline and tyre drag.

In the case that the tested vehicle is the representative vehicle of a road load matrix family, the coefficient B_m shall be set to zero and the coefficients A_m and C_m shall be recalculated with a least squares regression analysis.

4.3.2.5.3. Aerodynamic drag modelling

The aerodynamic drag coefficient $C_D(Y)$ shall be modelled as a four-term polynomial as a function of yaw angle Y as in the equation below:

$$C_D(Y) = a_0 + a_1 Y + a_2 Y^2 + a_3 Y^3 + a_4 Y^4$$

a_0 to a_4 are constant coefficients whose values are determined in the data analysis.

The aerodynamic drag shall be determined by combining the drag coefficient with the vehicle's frontal area A_f and the relative wind velocity v_r :

$$D_{\text{aero}} = \left(\frac{1}{2}\right) \times \rho \times A_f \times v_r^2 \times C_D(Y)$$

$$D_{\text{aero}} = \left(\frac{1}{2}\right) \times \rho \times A_f \times v_r^2 (a_0 + a_1 Y + a_2 Y^2 + a_3 Y^3 + a_4 Y^4)$$

4.3.2.5.4. Final equation of motion

Through substitution, the final form of the equation of motion becomes:

$$-m_e \left(\frac{dv}{dt}\right) = A_m + B_m v + C_m v^2 + \left(\frac{1}{2}\right) \times \rho \times A_f \times v_r^2 (a_0 + a_1 Y + a_2 Y^2 + a_3 Y^3 + a_4 Y^4) + (m \times g \times \frac{dh}{ds})$$

4.3.2.6. Data reduction

A three-term equation shall be generated to describe the road load force as a function of velocity, $F = A + Bv + Cv^2$, corrected to standard ambient temperature and pressure conditions, and in still air. The method for this analysis process is described in paragraphs 4.3.2.6.1. to 4.3.2.6.10. inclusive of this annex.

4.3.2.6.1. Determining calibration coefficients

If not previously determined, calibration factors to correct for vehicle blockage shall be determined for relative wind speed and yaw angle. Vehicle speed v , relative wind velocity v_r and yaw Y measurements during the warm-up phase of the test procedure shall be recorded. Paired runs in alternate directions on the test track at a constant velocity of 80 km/h shall be performed, and the arithmetic average values of v , v_r and Y for each run shall be determined. Calibration factors that minimize the total errors in head and cross winds over all the run pairs, i.e. the sum of $(\text{head}_i - \text{head}_{i+1})^2$, etc., shall be selected where head_i and head_{i+1} refer to wind speed and wind direction from the paired test runs in opposing directions during the vehicle warm-up/stabilization prior to testing.

4.3.2.6.2. Deriving second by second observations

From the data collected during the coastdown runs, values for v , $\left(\frac{dh}{ds}\right) \left(\frac{dv}{dt}\right)$, v_r^2 , and Y shall be determined by applying calibration factors obtained in

paragraphs 4.3.2.1.3. and 4.3.2.1.4. of this annex. Data filtering shall be used to adjust samples to a frequency of 1 Hz.

4.3.2.6.3. Preliminary analysis

Using a linear least squares regression technique, all data points shall be analysed at once to determine A_m , B_m , C_m , a_0 , a_1 , a_2 , a_3 and a_4 given m_e , $\left(\frac{dh}{ds}\right)$, $\left(\frac{dv}{dt}\right)$, v , v_r , and ρ .

4.3.2.6.4. Data outliers

A predicted force $m_e \left(\frac{dv}{dt}\right)$ shall be calculated and compared to the observed data points. Data points with excessive deviations, e.g., over three standard deviations, shall be flagged.

4.3.2.6.5. Data filtering (optional)

Appropriate data filtering techniques may be applied and the remaining data points shall be smoothed out.

4.3.2.6.6. Data elimination

Data points gathered where yaw angles are greater than ± 20 degrees from the direction of vehicle travel shall be flagged. Data points gathered where relative wind is less than + 5 km/h (to avoid conditions where tailwind speed is higher than vehicle speed) shall also be flagged. Data analysis shall be restricted to vehicle speeds within the speed range selected according to paragraph 4.3.2.2. of this annex.

4.3.2.6.7. Final data analysis

All data that has not been flagged shall be analysed using a linear least squares regression technique. Given m_e , $\left(\frac{dh}{ds}\right)$, $\left(\frac{dv}{dt}\right)$, v , v_r , and ρ , A_m , B_m , C_m , a_0 , a_1 , a_2 , a_3 and a_4 shall be determined.

4.3.2.6.8. Constrained analysis (optional)

To better separate the vehicle aerodynamic and mechanical drag, a constrained analysis may be applied such that the vehicle's frontal area A_f and the drag coefficient C_D may be fixed if they have been previously determined.

4.3.2.6.9. Correction to reference conditions

Equations of motion shall be corrected to reference conditions as specified in paragraph 4.5. of this annex.

4.3.2.6.10. Statistical criteria for on-board anemometry

The exclusion of each single pair of coastdown runs shall change the calculated road load for each coastdown reference speed v_j less than the convergence requirement, for all i and j :

$$\Delta F_i(v_j)/F(v_j) \leq \frac{0.030}{\sqrt{n-1}}$$

where:

$\Delta F_i(v_j)$ is the difference between the calculated road load with all coastdown runs and the calculated road load with the i^{th} pair of coastdown runs excluded, N;

$F(v_j)$ is the calculated road load with all coastdown runs included, N;

v_j is the reference speed, km/h;

n is the number of pairs of coastdown runs, all valid pairs are included.

In the case that the convergence requirement is not met, pairs shall be removed from the analysis, starting with the pair giving the highest change in calculated

road load, until the convergence requirement is met, as long as a minimum of 5 valid pairs are used for the final road load determination.

4.4. Measurement and calculation of running resistance using the torque meter method

As an alternative to the coastdown methods, the torque meter method may also be used in which the running resistance is determined by measuring wheel torque on the driven wheels at the reference speed points for time periods of at least 5 seconds.

4.4.1. Installation of torque meters

Wheel torque meters shall be installed between the wheel hub and the wheel of each driven wheel, measuring the required torque to keep the vehicle at a constant speed.

The torque meter shall be calibrated on a regular basis, at least once a year, traceable to national or international standards, in order to meet the required accuracy and precision.

4.4.2. Procedure and data sampling

4.4.2.1. Selection of reference speeds for running resistance curve determination

Reference speed points for running resistance determination shall be selected according to paragraph 2.2. of this annex.

The reference speeds shall be measured in descending order. At the request of the manufacturer, there may be stabilization periods between measurements but the stabilization speed shall not exceed the speed of the next reference speed.

4.4.2.2. Data collection

Data sets consisting of actual speed v_{ji} actual torque C_{ji} and time over a period of at least 5 seconds shall be measured for every v_j at a sampling frequency of at least 10 Hz. The data sets collected over one time period for a reference speed v_j shall be referred to as one measurement.

4.4.2.3. Vehicle torque meter measurement procedure

Prior to the torque meter method test measurement, a vehicle warm-up shall be performed according to paragraph 4.2.4. of this annex.

During test measurement, steering wheel movement shall be avoided as much as possible, and the vehicle brakes shall not be operated.

The test shall be repeated until the running resistance data satisfy the measurement precision requirements as specified in paragraph 4.4.3.2. of this annex.

4.4.2.4. Velocity deviation

During a measurement at a single reference speed point, the velocity deviation from the arithmetic average velocity ($v_{ji}-v_{jm}$) calculated according to paragraph 4.4.3. of this annex, shall be within the values in Table A4/6.

Additionally, the arithmetic average velocity v_{jm} at every reference speed point shall not deviate from the reference speed v_j by more than ± 1 km/h or 2 per cent of the reference speed v_j , whichever is greater.

Table A4/6
Velocity deviation

Time period, s	Velocity deviation, km/h
5 - 10	±0.2
10 - 15	±0.4
15 - 20	±0.6
20 - 25	±0.8
25 - 30	±1.0
≥ 30	±1.2

4.4.2.5. Atmospheric temperature

Tests shall be performed under the same temperature conditions as defined in paragraph 4.1.1.2. of this annex.

4.4.3. Calculation of arithmetic average velocity and arithmetic average torque

4.4.3.1. Calculation process

Arithmetic average velocity v_{jm} , km/h, and arithmetic average torque C_{jm} , in Nm, of each measurement shall be calculated from the data sets collected according to the requirements of paragraph 4.4.2.2. of this annex using the following equations:

$$v_{jm} = \frac{1}{k} \sum_{i=1}^k v_{ji}$$

and

$$C_{jm} = \frac{1}{k} \sum_{i=1}^k C_{ji} - C_{js}$$

where:

v_{ji} is the actual vehicle speed of the i^{th} data set at reference speed point j , km/h;

k is the number of data sets in a single measurement;

C_{ji} is the actual torque of the i^{th} data set, Nm;

C_{js} is the compensation term for speed drift, Nm, given by the following equation:

$$C_{js} = (m_{st} + m_r) \times \alpha_j r_j.$$

$\frac{C_{js}}{\frac{1}{k} \sum_{i=1}^k C_{ji}}$ shall be no greater than 0.05 and may be disregarded if α_j is not greater than $\pm 0.005 \text{ m/s}^2$;

m_{st} is the test vehicle mass at the start of the measurements and shall be measured immediately before the warm-up procedure and no earlier, kg;

m_r is the equivalent effective mass of rotating components according to paragraph 2.5.1. of this annex, kg;

r_j is the dynamic radius of the tyre determined at a reference point of 80 km/h or at the highest reference speed point of the vehicle if this speed is lower than 80 km/h, calculated using the following equation:

$$r_j = \frac{1}{3.6} \times \frac{v_{jm}}{2 \times \pi n}$$

where:

n is the rotational frequency of the driven tyre, s^{-1} ;

α_j is the arithmetic average acceleration, m/s², calculated using the following equation:

$$\alpha_j = \frac{1}{3.6} \times \frac{k \sum_{i=1}^k t_i v_{ji} - \sum_{i=1}^k t_i \sum_{i=1}^k v_{ji}}{k \times \sum_{i=1}^k t_i^2 - [\sum_{i=1}^k t_i]^2}$$

where:

t_i is the time at which the i^{th} data set was sampled, s.

4.4.3.2. Measurement precision

The measurements shall be carried out in opposite directions until a minimum of three pairs of measurements at each reference speed v_j have been obtained, for which \bar{C}_j satisfies the precision ρ_j according to the following equation:

$$\rho_j = \frac{h \times s}{\sqrt{n} \times \bar{C}_j} \leq 0.030$$

where:

n is the number pairs of measurements for C_{jmi} ;

\bar{C}_j is the running resistance at the speed v_j , Nm, given by the equation:

$$\bar{C}_j = \frac{1}{n} \sum_{i=1}^n C_{jmi}$$

where:

C_{jmi} is the arithmetic average torque of the i^{th} pair of measurements at speed v_j , Nm, and given by:

$$C_{jmi} = \frac{1}{2} \times (C_{jmai} + C_{jm bi})$$

where:

C_{jmai} and $C_{jm bi}$ are the arithmetic average torques of the i^{th} measurement at speed v_j determined in paragraph 4.4.3.1. of this annex for each direction, a and b respectively, Nm;

s is the standard deviation, Nm, calculated using the following equation:

$$s = \sqrt{\frac{1}{k-1} \sum_{i=1}^k (C_{jmi} - \bar{C}_j)^2}$$

h is a coefficient as a function of n as given in Table A4/4 in paragraph 4.3.1.4.2. of this annex.

4.4.4. Running resistance curve determination

The arithmetic average speed and arithmetic average torque at each reference speed point shall be calculated using the following equations:

$$V_{jm} = \frac{1}{2} \times (v_{jma} + v_{jmb})$$

$$C_{jm} = \frac{1}{2} \times (C_{jma} + C_{jmb})$$

The following least squares regression curve of arithmetic average running resistance shall be fitted to all the data pairs (v_{jm}, C_{jm}) at all reference speeds described in paragraph 4.4.2.1. of this annex to determine the coefficients c_0 , c_1 and c_2 .

The coefficients, c_0 , c_1 and c_2 , as well as the coastdown times measured on the chassis dynamometer (see paragraph 8.2.4. of this annex) shall be recorded.

In the case that the tested vehicle is the representative vehicle of a road load matrix family, the coefficient c_1 shall be set to zero and the coefficients c_0 and c_2 shall be recalculated with a least squares regression analysis.

4.5. Correction to reference conditions and measurement equipment

4.5.1. Air resistance correction factor

The correction factor for air resistance K_2 shall be determined using the following equation:

$$K_2 = \frac{T}{293 \text{ K}} \times \frac{100 \text{ kPa}}{P}$$

where:

T is the arithmetic average atmospheric temperature of all individual runs, Kelvin (K);

P is the arithmetic average atmospheric pressure, kPa.

4.5.2. Rolling resistance correction factor

The correction factor K_0 for rolling resistance, in Celsius⁻¹ (°C⁻¹), may be determined based on empirical data and approved by the responsible authority for the particular vehicle and tyre combination to be tested, or may be assumed to be as follows:

$$K_0 = 8.6 \times 10^{-3} \text{ °C}^{-1}$$

4.5.3. Wind correction

4.5.3.1. Wind correction when using stationary anemometry

Wind correction may be waived when the arithmetic average wind speed for each valid run pair is 2 m/s or less. In the case that wind speed is measured at more than one part of the test track, such as when the test is performed on an oval test track (see paragraph 4.1.1.1.1. of this annex), the wind speed shall be averaged at each measurement location and the higher of two average wind speeds shall be used to determine whether a wind speed correction is to be applied or may be waived.

4.5.3.1.1. The wind correction resistance w_1 for the coastdown method or w_2 for the torque meter method shall be calculated using the following equations:

$$w_1 = 3.6^2 \times f_2 \times v_w^2$$

$$\text{or: } w_2 = 3.6^2 \times c_2 \times v_w^2$$

where:

w_1 is the wind correction resistance for the coastdown method, N;

f_2 is the coefficient of the aerodynamic term determined according to paragraph 4.3.1.4.4. of this annex;

v_w in the case that wind speed is measured at only one point, v_w is the arithmetic average vector component of the wind speed parallel to the test road during all valid run pairs m/s;

v_w in the case that the wind speed is measured at two points, v_w is the lower of the two arithmetic average vector components of the wind speed parallel to the test road during all valid run pairs, m/s;

w_2 is the wind correction resistance for the torque meter method, Nm;

c_2 is the coefficient of the aerodynamic term for the torque meter method determined according to paragraph 4.4.4. of this annex.

4.5.3.2. Wind correction when using on-board anemometry

In the case that the coastdown method is based on on-board anemometry, w_1 and w_2 in the equations in paragraph 4.5.3.1.1. of this annex shall be set to zero, as the wind correction is already applied according to paragraph 4.3.2. of this annex.

4.5.4. Test mass correction factor

The correction factor K_1 for the test mass of the test vehicle shall be determined using the following equation:

$$K_1 = \left(1 - \frac{TM}{m_{av}}\right)$$

where:

TM is the test mass of the test vehicle, kg;

m_{av} is the arithmetic average of the test vehicle masses at the beginning and end of road load determination, kg.

4.5.5. Road load curve correction

4.5.5.1. The curve determined in paragraph 4.3.1.4.4. of this annex shall be corrected to reference conditions as follows:

$$F^* = ((f_0(1 - K_1) - w_1) + f_1v) \times (1 + K_0(T - 20)) + K_2f_2v^2$$

where:

F^* is the corrected road load, N;

f_0 is the constant road load coefficient, N;

f_1 is the first order road load coefficient, N/(km/h);

f_2 is the second order road load coefficient, N/(km/h)²;

K_0 is the correction factor for rolling resistance as defined in paragraph 4.5.2. of this annex;

K_1 is the test mass correction as defined in paragraph 4.5.4. of this annex;

K_2 is the correction factor for air resistance as defined in paragraph 4.5.1. of this annex;

T is the arithmetic average atmospheric temperature during all valid run pairs, °C;

v is vehicle velocity, km/h;

w_1 is the wind resistance correction as defined in paragraph 4.5.3. of this annex, N.

The result of the calculation below shall be used as the target road load coefficient A_t in the calculation of the chassis dynamometer load setting described in paragraph 8.1. of this annex:

$$((f_0(1 - K_1) - w_1)) \times (1 + K_0(T - 20)).$$

The result of the calculation below shall be used as the target road load coefficient B_t in the calculation of the chassis dynamometer load setting described in paragraph 8.1. of this annex:

$$(f_1 \times (1 + K_0 \times (T-20))).$$

The result of the calculation below shall be used as the target road load coefficient C_t in the calculation of the chassis dynamometer load setting described in paragraph 8.1. of this annex:

$$(K_2 \times f_2).$$

4.5.5.2. The curve determined in paragraph 4.4.4. of this annex shall be corrected to reference conditions and measurement equipment installed according to the following procedure.

4.5.5.2.1. Correction to reference conditions

$$C^* = ((c_0(1 - K_1) - w_2) + c_1v) \times (1 + K_0(T - 20)) + K_2f_2v^2$$

where:

- C^* is the corrected running resistance, Nm;
- c_0 is the constant term as determined in paragraph 4.4.4. of this annex, Nm;
- c_1 is the coefficient of the first order term as determined in paragraph 4.4.4. of this annex, Nm/(km/h);
- c_2 is the coefficient of the second order term as determined in paragraph 4.4.4. of this annex, Nm/(km/h)²;
- K_0 is the correction factor for rolling resistance as defined in paragraph 4.5.2. of this annex;
- K_1 is the test mass correction as defined in paragraph 4.5.4. of this annex;
- K_2 is the correction factor for air resistance as defined in paragraph 4.5.1. of this annex;
- v is the vehicle velocity, km/h;
- T is the arithmetic average atmospheric temperature during all valid run pairs, °C;
- w_2 is the wind correction resistance as defined in paragraph 4.5.3. of this annex.

4.5.5.2.2. Correction for installed torque meters

If the running resistance is determined according to the torque meter method, the running resistance shall be corrected for effects of the torque measurement equipment installed outside the vehicle on its aerodynamic characteristics.

The running resistance coefficient c_2 shall be corrected using the following equation:

$$c_{2\text{corr}} = K_2 \times c_2 \times (1 + (\Delta(C_D \times A_f))/(C_{D'} \times A_{f'}))$$

where:

$$\Delta(C_D \times A_f) = (C_D \times A_f) - (C_{D'} \times A_{f'});$$

$C_{D'} \times A_{f'}$ is the product of the aerodynamic drag coefficient multiplied by the frontal area of the vehicle with the torque meter measurement equipment installed measured in a wind tunnel fulfilling the criteria of paragraph 3.2. of this annex, m²;

$C_D \times A_f$ is the product of the aerodynamic drag coefficient multiplied by the frontal area of the vehicle with the torque meter measurement equipment not installed measured in a wind tunnel fulfilling the criteria of paragraph 3.2. of this annex, m².

4.5.5.2.3. Target running resistance coefficients

The result of the calculation below shall be used as the target running resistance coefficient a_t in the calculation of the chassis dynamometer load setting described in paragraph 8.2. of this annex:

$$((c_0(1 - K_1) - w_2)) \times (1 + K_0(T - 20)).$$

The result of the calculation below shall be used as the target running resistance coefficient b_t in the calculation of the chassis dynamometer load setting described in paragraph 8.2. of this annex:

$$(c_1 \times (1 + K_0 \times (T-20))).$$

The result of the calculation below shall be used as the target running resistance coefficient c_t in the calculation of the chassis dynamometer load setting described in paragraph 8.2. of this annex:

$$(c_{2corr} \times r).$$

5. Method for the calculation of road load or running resistance based on vehicle parameters

5.1. Calculation of road load and running resistance for vehicles based on a representative vehicle of a road load matrix family

If the road load of the representative vehicle is determined according to a coastdown method described in paragraph 4.3. of this annex or according to the wind tunnel method described in paragraph 6. of this annex, the road load of an individual vehicle shall be calculated according to paragraph 5.1.1. of this annex.

If the running resistance of the representative vehicle is determined according to the torque meter method described in paragraph 4.4. of this annex, the running resistance of an individual vehicle shall be calculated according to paragraph 5.1.2. of this annex.

5.1.1. For the calculation of the road load of vehicles of a road load matrix family, the vehicle parameters described in paragraph 4.2.1.4. of this annex and the road load coefficients of the representative test vehicle determined in paragraph 4.3. of this annex shall be used.

5.1.1.1. The road load force for an individual vehicle shall be calculated using the following equation:

$$F_c = f_0 + (f_1 \times v) + (f_2 \times v^2)$$

where:

F_c is the calculated road load force as a function of vehicle velocity, N;

f_0 is the constant road load coefficient, N, defined by the equation:

$$f_0 = \text{Max}((0.05 \times f_{0r} + 0.95 \times (f_{0r} \times \text{TM}/\text{TM}_r + (\frac{\text{RR} - \text{RR}_r}{1000}) \times 9.81 \times \text{TM})); \\ (0.2 \times f_{0r} + 0.8 \times (f_{0r} \times \text{TM}/\text{TM}_r + (\frac{\text{RR} - \text{RR}_r}{1000}) \times 9.81 \times \text{TM})))$$

f_{0r} is the constant road load coefficient of the representative vehicle of the road load matrix family, N;

f_1 is the first order road load coefficient, N/(km/h), and shall be set to zero;

f_2 is the second order road load coefficient, N/(km/h)², defined by the equation:

$$f_2 = \text{Max}((0.05 \times f_{2r} + 0.95 \times f_{2r} \times A_f / A_{fr}); (0.2 \times f_{2r} + 0.8 \times f_{2r} \times A_f / A_{fr}))$$

f_{2r} is the second order road load coefficient of the representative vehicle of the road load matrix family, N/(km/h)²;

v is the vehicle speed, km/h;

TM is the actual test mass of the individual vehicle of the road load matrix family, kg;

TM_r is the test mass of the representative vehicle of the road load matrix family, kg;

- A_f is the frontal area of the individual vehicle of the road load matrix family, m²;
- A_{fr} is the frontal area of the representative vehicle of the road load matrix family, m²;
- RR is the tyre rolling resistance of the individual vehicle of the road load matrix family, kg/tonne;
- RR_r is the tyre rolling resistance of the representative vehicle of the road load matrix family, kg/tonne.

For the tyres fitted to an individual vehicle, the value of the rolling resistance RR shall be set to the class value of the applicable tyre energy efficiency class according to Table A4/2 of Annex B4.

If the tyres on the front and rear axles belong to different energy efficiency classes, the weighted mean shall be used, calculated using the equation in paragraph 3.2.3.2.2.2. of Annex B7.

If the same tyres were fitted to test vehicles L and H, the value of RR_{ind} when using the interpolation method shall be set to RR_H .

- 5.1.2. For the calculation of the running resistance of vehicles of a road load matrix family, the vehicle parameters described in paragraph 4.2.1.4. of this annex and the running resistance coefficients of the representative test vehicle determined in paragraph 4.4. of this annex shall be used.
- 5.1.2.1. The running resistance for an individual vehicle shall be calculated using the following equation:

$$C_c = c_0 + c_1 \times v + c_2 \times v^2$$

where:

- C_c is the calculated running resistance as a function of vehicle velocity, Nm;
- c_0 is the constant running resistance coefficient, Nm, defined by the equation:

$$c_0 = r'/1.02 \times \text{Max}((0.05 \times 1.02 \times c_{0r}/r' + 0.95 \times (1.02 \times c_{0r}/r' \times TM/TM_r + (\frac{RR - RR_r}{1000}) \times 9.81 \times TM)); (0.2 \times 1.02 \times c_{0r}/r' + 0.8 \times (1.02 \times c_{0r}/r' \times TM/TM_r + (\frac{RR - RR_r}{1000}) \times 9.81 \times TM)))$$

- c_{0r} is the constant running resistance coefficient of the representative vehicle of the road load matrix family, Nm;
- c_1 is the first order running resistance coefficient, Nm/(km/h), and shall be set to zero;
- c_2 is the second order running resistance coefficient, Nm/(km/h)², defined by the equation:

$$c_2 = r'/1.02 \times \text{Max}((0.05 \times 1.02 \times c_{2r}/r' + 0.95 \times 1.02 \times c_{2r}/r' \times A_f/A_{fr}); (0.2 \times 1.02 \times c_{2r}/r' + 0.8 \times 1.02 \times c_{2r}/r' \times A_f/A_{fr}))$$

- c_{2r} is the second order running resistance coefficient of the representative vehicle of the road load matrix family, N/(km/h)²;
- v is the vehicle speed, km/h;
- TM is the actual test mass of the individual vehicle of the road load matrix family, kg;
- TM_r is the test mass of the representative vehicle of the road load matrix family, kg;
- A_f is the frontal area of the individual vehicle of the road load matrix family, m²;

- A_{fr} is the frontal area of the representative vehicle of the road load matrix family, m²;
- RR is the tyre rolling resistance of the individual vehicle of the road load matrix family, kg/tonne;
- RR_r is the tyre rolling resistance of the representative vehicle of the road load matrix family, kg/tonne;
- r' is the dynamic radius of the tyre on the chassis dynamometer obtained at 80 km/h, m;
- 1.02 is an approximate coefficient compensating for drivetrain losses.

5.2. Calculation of the default road load based on vehicle parameters

5.2.1. As an alternative for determining road load with the coastdown or torque meter method, a calculation method for default road load may be used.

For the calculation of a default road load based on vehicle parameters, several parameters such as test mass, width and height of the vehicle shall be used. The default road load F_c shall be calculated for the reference speed points.

5.2.2. The default road load force shall be calculated using the following equation:

$$F_c = f_0 + (f_1 \times v) + (f_2 \times v^2)$$

where:

F_c is the calculated default road load force as a function of vehicle velocity, N;

f_0 is the constant road load coefficient, N, defined by the following equation:

$$f_0 = 0.140 \times TM;$$

f_1 is the first order road load coefficient, N/(km/h), and shall be set to zero;

f_2 is the second order road load coefficient, N/(km/h)², defined by the following equation:

$$f_2 = (2.8 \times 10^{-6} \times TM) + (0.0170 \times \text{width} \times \text{height});$$

v is vehicle velocity, km/h;

TM test mass, kg;

width vehicle width as defined in 6.2. of Standard ISO 612:1978, m;

height vehicle height as defined in 6.3. of Standard ISO 612:1978, m.

6. Wind tunnel method

The wind tunnel method is a road load measurement method using a combination of a wind tunnel and a chassis dynamometer or of a wind tunnel and a flat belt dynamometer. The test benches may be separate facilities or integrated with one another.

6.1. Measurement method

6.1.1. The road load shall be determined by:

- (a) adding the road load forces measured in a wind tunnel and those measured using a flat belt dynamometer; or
- (b) adding the road load forces measured in a wind tunnel and those measured on a chassis dynamometer.

6.1.2. Aerodynamic drag shall be measured in the wind tunnel.

6.1.3. Rolling resistance and drivetrain losses shall be measured using a flat belt or a chassis dynamometer, measuring the front and rear axles simultaneously.

6.2. Approval of the facilities by the responsible authority

The results of the wind tunnel method shall be compared to those obtained using the coastdown method to demonstrate qualification of the facilities and recorded.

6.2.1. Three vehicles shall be selected by the responsible authority. The vehicles shall cover the range of vehicles (e.g. size, weight) planned to be measured with the facilities concerned.

6.2.2. Two separate coastdown tests shall be performed with each of the three vehicles according to paragraph 4.3. of this annex, and the resulting road load coefficients, f_0 , f_1 and f_2 , shall be determined according to that paragraph and corrected according to paragraph 4.5.5. of this annex. The coastdown test result of a test vehicle shall be the arithmetic average of the road load coefficients of its two separate coastdown tests. If more than two coastdown tests are necessary to fulfil the approval of facilities' criteria, all valid tests shall be averaged.

6.2.3. Measurement with the wind tunnel method according to paragraphs 6.3. to 6.7. inclusive of this annex shall be performed on the same three vehicles as selected in paragraph 6.2.1. of this annex and in the same conditions, and the resulting road load coefficients, f_0 , f_1 and f_2 , shall be determined.

If the manufacturer chooses to use one or more of the available alternative procedures within the wind tunnel method (i.e. paragraph 6.5.2.1. on preconditioning, paragraphs 6.5.2.2. and 6.5.2.3. on the procedure, including paragraph 6.5.2.3.3. on dynamometer setting), these procedures shall also be used also for the approval of the facilities.

6.2.4. Approval criteria

The facility or combination of facilities used shall be approved if both of the following two criteria are fulfilled:

(a) The difference in cycle energy, expressed as ε_k , between the wind tunnel method and the coastdown method shall be within ± 0.05 for each of the three vehicles k according to the following equation:

$$\varepsilon_k = \frac{E_{k,WTM}}{E_{k,coastdown}} - 1$$

where:

ε_k is the difference in cycle energy over a complete Class 3 WLTC for vehicle k between the wind tunnel method and the coastdown method, per cent;

$E_{k,WTM}$ is the cycle energy over a complete Class 3 WLTC for vehicle k , calculated with the road load derived from the wind tunnel method (WTM) calculated according to paragraph 5. of Annex B7, J;

$E_{k,coastdown}$ is the cycle energy over a complete Class 3 WLTC for vehicle k , calculated with the road load derived from the coastdown method calculated according to paragraph 5. of Annex B7, J.; and

(b) The arithmetic average \bar{x} of the three differences shall be within 0.02.

$$\bar{x} = \left| \frac{\varepsilon_1 + \varepsilon_2 + \varepsilon_3}{3} \right|$$

The approval shall be recorded by the responsible authority including measurement data and the facilities concerned.

The facility may be used for road load determination for a maximum of two years after the approval has been granted.

Each combination of roller chassis dynamometer or moving belt and wind tunnel shall be approved separately.

Every combination of wind speeds (see paragraph 6.4.3. of this annex) used for the determination of road load values shall be validated separately.

6.3. Vehicle preparation and temperature

Conditioning and preparation of the vehicle shall be performed according to paragraphs 4.2.1. and 4.2.2. of this annex and applies to both the flat belt or roller chassis dynamometers and the wind tunnel measurements.

In the case that the alternative warm-up procedure described in paragraph 6.5.2.1. of this annex is applied, the target test mass adjustment, the weighing of the vehicle and the measurement shall all be performed without the driver in the vehicle.

The flat belt or the chassis dynamometer test cells shall have a temperature set point of 20 °C with a tolerance of ± 3 °C. At the request of the manufacturer, the set point may also be 23 °C with a tolerance of ± 3 °C.

6.4. Wind tunnel procedure

6.4.1. Wind tunnel criteria

The wind tunnel design, test methods and the corrections shall provide a value of $(C_D \times A_f)$ representative of the on-road $(C_D \times A_f)$ value and with a repeatability of ± 0.015 m².

For all $(C_D \times A_f)$ measurements, the wind tunnel criteria listed in paragraph 3.2. of this annex shall be met with the following modifications:

- (a) The solid blockage ratio described in paragraph 3.2.4. of this annex shall be less than 25 per cent;
- (b) The belt surface contacting any tyre shall exceed the length of that tyre's contact area by at least 20 per cent and shall be at least as wide as that contact patch;
- (c) The standard deviation of total air pressure at the nozzle outlet described in paragraph 3.2.8. of this annex shall be less than 1 per cent;
- (d) The restraint system blockage ratio described in paragraph 3.2.10. of this annex shall be less than 3 per cent;
- (e) Additionally to the requirement defined in paragraph 3.2.11. of this annex, when measuring Class 1 vehicles, the precision of the measured force shall not exceed ± 2.0 N.

6.4.2. Wind tunnel measurement

The vehicle shall be in the condition described in paragraph 6.3. of this annex.

The vehicle shall be placed parallel to the longitudinal centre line of the tunnel with a maximum tolerance of ± 10 mm.

The vehicle shall be placed with a yaw angle of 0 ° within a tolerance of ± 0.1 °.

Aerodynamic drag shall be measured for at least for 60 seconds and at a minimum frequency of 5 Hz. Alternatively, the drag may be measured at a minimum frequency of 1 Hz and with at least 300 subsequent samples. The result shall be the arithmetic average of the drag.

Prior to a test it shall be checked that at the aerodynamic force measured at a wind speed of 0 km/h yields a result equal to 0 Newtons.

In the case that the vehicle has movable aerodynamic body parts, paragraph 4.2.1.5. of this annex shall apply. Where movable parts are velocity-dependent, every applicable position shall be measured in the wind tunnel and evidence shall be provided to the responsible authority indicating the

relationship between reference speed, movable part position, and the corresponding ($C_D \times A_f$).

6.4.3. Wind speeds for wind tunnel measurement

The aerodynamic force shall be measured at two wind speeds under the following speed conditions:

(a) Class 1 vehicles

Lower wind speed v_{low} to measure aerodynamic force shall be $v_{low} < 80$ km/h;

Higher wind speed v_{high} shall be ($v_{low} + 40$ km/h $\leq v_{high} \leq 150$ km/h).

(b) Class 2 and 3 vehicles

Lower wind speed v_{low} to measure aerodynamic force shall be 80 km/h $\leq v_{low} \leq 100$ km/h;

Higher wind speed shall be ($v_{low} + 40$ km/h $\leq v_{high} \leq 150$ km).

6.5. Flat belt applied for the wind tunnel method

6.5.1. Flat belt criteria

6.5.1.1. Description of the flat belt test bench

The wheels shall rotate on flat belts that do not change the rolling characteristics of the wheels compared to those on the road. The measured forces in the x-direction shall include the frictional forces in the drivetrain.

6.5.1.2. Vehicle restraint system

The dynamometer shall be equipped with a centring device aligning the vehicle within a tolerance of ± 0.5 degrees of rotation around the z-axis. The restraint system shall maintain the centred drive wheel position throughout the coastdown runs of the road load determination within the following limits:

6.5.1.2.1. Lateral position (y-axis)

The vehicle shall remain aligned in the y-direction and lateral movement shall be minimised.

6.5.1.2.2. Front and rear position (x-axis)

Additional to the requirement of paragraph 6.5.1.2.1. of this annex, both wheel axes shall be within ± 10 mm of the belt's lateral centre lines.

6.5.1.2.3. Vertical force

The restraint system shall be designed so as to impose no vertical force on the drive wheels.

6.5.1.3. Accuracy of measured forces

Only the reaction force for turning the wheels shall be measured. No external forces shall be included in the result (e.g. force of the cooling fan air, vehicle restraints, aerodynamic reaction forces of the flat belt, dynamometer losses, etc.).

The force in the x-direction shall be measured with an accuracy of ± 5 N.

6.5.1.4. Flat belt speed control

The belt speed shall be controlled with an accuracy of ± 0.1 km/h.

6.5.1.5. Flat belt surface

The flat belt surface shall be clean, dry and free from foreign material that might cause tyre slippage.

6.5.1.6. Cooling

A current of air of variable speed shall be blown towards the vehicle. The set point of the linear velocity of the air at the blower outlet shall be equal to the corresponding dynamometer speed above measurement speeds of 5 km/h. The

linear velocity of the air at the blower outlet shall be within ± 5 km/h or ± 10 per cent of the corresponding measurement speed, whichever is greater.

6.5.2. Flat belt measurement

The measurement procedure may be performed according to either paragraph 6.5.2.2. or paragraph 6.5.2.3. of this annex.

6.5.2.1. Preconditioning

The vehicle shall be conditioned on the dynamometer as described in paragraphs 4.2.4.1.1. to 4.2.4.1.3. inclusive of this annex.

The dynamometer load setting F_d for the preconditioning shall be:

$$F_d = a_d + (b_d \times v) + (c_d \times v^2)$$

where in the case of applying paragraph 6.7.2.1:

$$a_d = 0$$

$$b_d = f_{1a};$$

$$c_d = f_{2a}$$

or, where in the case of applying paragraph 6.7.2.2.:

$$a_d = 0$$

$$b_d = 0$$

$$c_d = (C_D \times A_f) \times \frac{\rho_0}{2} \times \frac{1}{3.6^2}$$

The equivalent inertia of the dynamometer shall be the test mass.

The aerodynamic drag used for the load setting shall be taken from paragraph 6.7.2. of this annex and may be set directly as input. Otherwise, a_d , b_d , and c_d from this paragraph shall be used.

At the request of the manufacturer, as an alternative to paragraph 4.2.4.1.2. of this annex, the warm-up may be conducted by driving the vehicle with the flat belt.

In this case, the warm-up speed shall be 110 per cent of the maximum speed of the applicable WLTC. The warm up is considered complete when the vehicle has been driven for at least 1,200 seconds and the change of measured force over a period of 200 seconds is less than 5 N.

6.5.2.2. Measurement procedure with stabilised speeds

6.5.2.2.1. The test shall be conducted from the highest to the lowest reference speed point.

6.5.2.2.2. Immediately after the measurement at the previous speed point, the deceleration from the current to the next applicable reference speed point shall be performed in a smooth transition of approximately 1 m/s².

6.5.2.2.3. The reference speed shall be stabilised for at least 4 seconds and for a maximum of 10 seconds. The measurement equipment shall ensure that the signal of the measured force is stabilised after that period.

6.5.2.2.4. The force at each reference speed shall be measured for at least 6 seconds while the vehicle speed is kept constant. The resulting force for that reference speed point $F_{j\text{Dyno}}$ shall be the arithmetic average of the force during the measurement.

6.5.2.2.5. The steps in paragraphs 6.5.2.2.2. to 6.5.2.2.4. inclusive of this annex shall be repeated for each reference speed.

6.5.2.3. Measurement procedure by deceleration

6.5.2.3.1. Preconditioning and dynamometer setting shall be performed according to paragraph 6.5.2.1. of this annex. Prior to each coastdown, the vehicle shall be driven at the highest reference speed or, in the case that the alternative warm-up procedure is used at 110 per cent of the highest reference speed, for at least 1 minute. The vehicle shall be subsequently accelerated to at least 10 km/h above the highest reference speed and the coastdown shall be started immediately.

6.5.2.3.2.

The measurement shall be performed according to paragraphs 4.3.1.3.1. to 4.3.1.4.4. inclusive of this annex but excluding paragraph 4.3.1.4.2., where Δt_{ja} and Δt_{jb} are replaced by Δt_j . The measurement shall be stopped after two decelerations if the force of both coastdowns at each reference speed point is within ± 10 N, otherwise at least three coastdowns shall be performed using the criteria set out in paragraph 4.3.1.4.2. of this annex.

6.5.2.3.3. The force f_{jDyno} at each reference speed v_j shall be calculated by removing the dynamometer set force:

$$f_{jDyno} = f_{jDecel} - f_{dj}$$

where:

f_{jDecel} is the force determined according to the equation calculating F_j in paragraph 4.3.1.4.4. of this annex at reference speed point j , N;

f_{dj} is the force determined to the equation calculating F_d in paragraph 6.5.2.1. of this annex at reference speed point j , N.

Alternatively, at the request of the manufacturer, c_d may be set to zero during the coastdown and for calculating f_{jDyno} .

6.5.2.4. Measurement conditions

The vehicle shall be in the condition described in paragraph 4.3.1.3.2. of this annex.

6.5.3. Measurement result of the flat belt method

The result of the flat belt dynamometer f_{jDyno} shall be referred to as f_j for the further calculations in paragraph 6.7. of this annex.

6.6. Chassis dynamometer applied for the wind tunnel method

6.6.1. Criteria

In addition to the descriptions in paragraphs 1. and 2. of Annex B5, the criteria described in paragraphs 6.6.1.1. to 6.6.1.6. shall apply.

6.6.1.1. Description of a chassis dynamometer

The front and rear axles shall be equipped with a single roller with a diameter of not less than 1.2 metres.

6.6.1.2. Vehicle restraint system

The dynamometer shall be equipped with a centring device aligning the vehicle. The restraint system shall maintain the centred drive wheel position within the following recommended limits throughout the coastdown runs of the road load determination:

6.6.1.2.1. Vehicle position

The vehicle to be tested shall be installed on the chassis dynamometer roller as defined in paragraph 7.3.3. of this annex.

6.6.1.2.2. Vertical force

The restraint system shall fulfil the requirements of paragraph 6.5.1.2.3. of this annex.

6.6.1.3. Accuracy of measured forces

The accuracy of measured forces shall be as described in paragraph 6.5.1.3. of this annex apart from the force in the x-direction that shall be measured with an accuracy as described in paragraph 2.4.1. of Annex B5.

6.6.1.4. Dynamometer speed control

The roller speeds shall be controlled with an accuracy of ± 0.2 km/h.

6.6.1.5. Roller surface

The roller surface shall be clean, dry and free from foreign material that might cause tyre slippage.

6.6.1.6. Cooling

The cooling fan shall be as described in paragraph 6.5.1.6. of this annex.

6.6.2. Dynamometer measurement

The measurement shall be performed as described in paragraph 6.5.2. of this annex.

6.6.3. Correcting measured chassis dynamometer forces to those on a flat surface

The measured forces on the chassis dynamometer shall be corrected to a reference equivalent to the road (flat surface) and the result shall be referred to as f_j .

$$f_j = f_{j\text{Dyno}} \times c1 \times \sqrt{\frac{1}{\frac{R_{\text{Wheel}}}{R_{\text{Dyno}}} \times c2 + 1}} + f_{j\text{Dyno}} \times (1 - c1)$$

where:

$c1$ is the tyre rolling resistance fraction of $f_{j\text{Dyno}}$;

$c2$ is a chassis dynamometer-specific radius correction factor;

$f_{j\text{Dyno}}$ is the force calculated in paragraph 6.5.2.3.3. of this annex for each reference speed j , N;

R_{Wheel} is one-half of the nominal design tyre diameter, m;

R_{Dyno} is the radius of the chassis dynamometer roller, m.

The manufacturer and the responsible authority shall agree on the factors $c1$ and $c2$ to be used, based on correlation test evidence provided by the manufacturer for the range of tyre characteristics intended to be tested on the chassis dynamometer.

As an alternative the following conservative equation may be used:

$$f_j = f_{j\text{Dyno}} \times \sqrt{\frac{1}{\frac{R_{\text{Wheel}}}{R_{\text{Dyno}}} \times 0.2 + 1}}$$

$C2$ shall be 0.2 except that 2.0 shall be used if the road load delta method (see paragraph 6.8. of this annex) is used and the road load delta calculated according to paragraph 6.8.1. of this annex is negative.

6.7. Calculations

6.7.1. Correction of the flat belt and chassis dynamometer results

The measured forces determined in paragraphs 6.5. and 6.6. of this annex shall be corrected to reference conditions using the following equation:

$$F_{Dj} = (f_j(1 - K_1)) \times (1 + K_0(T - 293))$$

where:

F_{Dj} is the corrected resistance measured at the flat belt or chassis dynamometer at reference speed j , N;

f_j is the measured force at reference speed j , N;

K_0 is the correction factor for rolling resistance as defined in paragraph 4.5.2. of this annex, K^{-1} ;

K_1 is the test mass correction as defined in paragraph 4.5.4. of this annex, N;

T is the arithmetic average temperature in the test cell during the measurement, K.

6.7.2. Calculation of the aerodynamic force

The calculation in paragraph 6.7.2.1. shall be applied considering the results of both wind speeds. However, if the difference of the product of the drag coefficient and frontal area ($C_D \times A_f$) measured at the wind speeds v_{low} and v_{high} is less than 0.015 m^2 , the calculation in paragraph 6.7.2.2. may be applied at the request of the manufacturer.

6.7.2.1. The aerodynamic force of each wind speed F_{0wind} , F_{low} , and F_{high} shall be calculated using the equation below.

$$F_{Aw} = (C_D \times A_f)_w \times \frac{\rho_0}{2} \times \frac{v_w^2}{3.6^2}$$

where:

$(C_D \times A_f)_j$ is the product of the drag coefficient and frontal area measured in the wind tunnel at a certain reference speed point j , if applicable, m^2 ;

ρ_0 is the dry air density defined in paragraph 3.2.10. of this Regulation, kg/m^3 ;

F_w is the aerodynamic force calculated at wind speed w , N;

v_w is the applicable wind speed, km/h .

w is the reference to the applicable wind speed "0wind", "low" and "high";

F_{0wind} is the aerodynamic force at $0 \text{ km}/\text{h}$, N;

F_{low} is the aerodynamic force at v_{low} , N;

F_{high} is the aerodynamic force at v_{high} , N.

The aerodynamic force coefficients f_{1a} and f_{2a} shall be calculated with a least square regression analysis using F_{0wind} , F_{low} , and F_{high} and the equation below:

$$F = f_{1a} \times v + f_{2a} \times v^2$$

The final result for the aerodynamic force F_{Aj} shall be calculated with the equation below at each reference speed point v_j . If the vehicle is equipped with velocity-dependent movable aerodynamic body parts, the

corresponding aerodynamic force shall be applied for the reference speed points concerned.

$$F_{Aj} = f_{1a} \times v_j + f_{2a} \times v_j^2$$

- 6.7.2.2. The aerodynamic force shall be calculated using the equation below, where the final $(C_D \times A_f)$ of that wind speed shall be used, that is also used for determination of optional equipment within the interpolation method. If the vehicle is equipped with velocity-dependent movable aerodynamic body parts, the corresponding $(C_D \times A_f)$ values shall be applied for the reference speed points concerned.

$$F_{Aj} = (C_D \times A_f)_j \times \frac{\rho_0}{2} \times \frac{v_j^2}{3.6^2}$$

where:

- F_{Aj} is the aerodynamic force calculated at reference speed j , N;
- $(C_D \times A_f)_j$ is the product of the drag coefficient and frontal area measured in the wind tunnel at a certain reference speed point j , if applicable, m²;
- ρ_0 is the dry air density defined in paragraph 3.2.10. of this Regulation, kg/m³;
- v_j is the reference speed j , km/h.

- 6.7.3. Calculation of road load values

The total road load as a sum of the results of paragraphs 6.7.1 and 6.7.2. of this annex shall be calculated using the following equation:

$$F_j^* = F_{Dj} + F_{Aj}$$

for all applicable reference speed points j , N.

For all calculated F_j^* , the coefficients f_0 , f_1 and f_2 in the road load equation shall be calculated with a least squares regression analysis and shall be used as the target coefficients in paragraph 8.1.1. of this annex.

In the case that the vehicle tested according to the wind tunnel method is representative of a road load matrix family vehicle, the coefficient f_1 shall be set to zero and the coefficients f_0 and f_2 shall be recalculated with a least squares regression analysis.

- 6.8. Road load delta method

For the purpose of including options when using the interpolation method which are not incorporated in the road load interpolation (i.e. aerodynamics, rolling resistance and mass), a delta in vehicle friction may be measured by the road load delta method (e.g. friction difference between brake systems). The following steps shall be performed:

- (a) The friction of reference vehicle R shall be measured;
- (b) The friction of the vehicle with the option (vehicle N) causing the difference in friction shall be measured;
- (c) The difference shall be calculated according to paragraph 6.8.1. of this annex.

These measurements shall be performed on a flat belt according to paragraph 6.5. of this annex or on a chassis dynamometer according to paragraph 6.6. of this annex, and the correction of the results (excluding aerodynamic force) calculated according to paragraph 6.7.1. of this annex.

The application of this method is permitted only if the following criterion is fulfilled:

$$\left| \frac{1}{n} \sum_{j=1}^n (F_{Dj,R} - F_{Dj,N}) \right| \leq 25 \text{ N}$$

where:

$F_{Dj,R}$ is the corrected resistance of vehicle R measured on the flat belt or chassis dynamometer at reference speed j calculated according to paragraph 6.7.1. of this annex, N;

$F_{Dj,N}$ is the corrected resistance of vehicle N measured on the flat belt or chassis dynamometer at reference speed j calculated according to paragraph 6.7.1. of this annex, N;

n is the total number of speed points.

This alternative road load determination method may only be applied if vehicles R and N have identical aerodynamic resistance and if the measured delta appropriately covers the entire influence on the vehicle's energy consumption. This method shall not be applied if the overall accuracy of the absolute road load of vehicle N is compromised in any way.

6.8.1. Determination of delta flat belt or chassis dynamometer coefficients

The delta road load shall be calculated using the following equation:

$$F_{Dj,Delta} = F_{Dj,N} - F_{Dj,R}$$

where:

$F_{Dj,Delta}$ is the delta road load at reference speed j, N;

$F_{Dj,N}$ is the corrected resistance measured on the flat belt or chassis dynamometer at reference speed j calculated according to paragraph 6.7.1. of this annex for vehicle N, N;

$F_{Dj,R}$ is the corrected resistance of the reference vehicle measured on the flat belt or chassis dynamometer at reference speed j calculated according to paragraph 6.7.1. of this annex for reference vehicle R, N.

For all calculated $F_{Dj,Delta}$, the coefficients $f_{0,Delta}$, $f_{1,Delta}$ and $f_{2,Delta}$ in the road load equation shall be calculated with a least squares regression analysis.

6.8.2. Determination of total road load

If the interpolation method (see paragraph 3.2.3.2. of Annex B7) is not used, the road load delta method for vehicle N shall be calculated according to the following equations:

$$f_{0,N} = f_{0,R} + f_{0,Delta}$$

$$f_{1,N} = f_{1,R} + f_{1,Delta}$$

$$f_{2,N} = f_{2,R} + f_{2,Delta}$$

where:

N refers to the road load coefficients of vehicle N;

R refers to the road load coefficients of reference vehicle R;

Delta refers to the delta road load coefficients determined in paragraph 6.8.1. of this annex.

7. Transferring road load to a chassis dynamometer
- 7.1. Preparation for chassis dynamometer test
 - 7.1.0. Selection of dynamometer operation

The test shall be carried out in accordance with paragraph 2.4.2.4. of Annex B6.
 - 7.1.1. Laboratory conditions
 - 7.1.1.1. Roller(s)

The chassis dynamometer roller(s) shall be clean, dry and free from foreign material that might cause tyre slippage. The dynamometer shall be run in the same coupled or uncoupled state as the subsequent Type 1 test. Chassis dynamometer speed shall be measured from the roller coupled to the power absorption unit.
 - 7.1.1.1.1. Tyre slippage

Additional weight may be placed on or in the vehicle to eliminate tyre slippage. The manufacturer shall perform the load setting on the chassis dynamometer with the additional weight. The additional weight shall be present for both load setting and the emissions and fuel consumption tests. The use of any additional weight shall be recorded.
 - 7.1.1.2. Room temperature

The laboratory atmospheric temperature shall be at a set point of 23 °C and shall not deviate by more than ± 5 °C during the test unless otherwise required by any subsequent test.
 - 7.2. Preparation of chassis dynamometer
 - 7.2.1. Inertia mass setting

The equivalent inertia mass of the chassis dynamometer shall be set according to paragraph 2.5.3. of this annex. If the chassis dynamometer is not capable to meet the inertia setting exactly, the next higher inertia setting shall be applied with a maximum increase of 10 kg.
 - 7.2.2. Chassis dynamometer warm-up

The chassis dynamometer shall be warmed up in accordance with the dynamometer manufacturer's recommendations, or as appropriate, so that the frictional losses of the dynamometer may be stabilized.
 - 7.3. Vehicle preparation
 - 7.3.1. Tyre pressure adjustment

The tyre pressure at the soak temperature of a Type 1 test shall be set to no more than 50 per cent above the lower limit of the tyre pressure range for the selected tyre, as specified by the vehicle manufacturer (see paragraph 4.2.2.3. of this annex), and shall be recorded.
 - 7.3.2. If the determination of dynamometer settings cannot meet the criteria described in paragraph 8.1.3. of this annex due to non-reproducible forces, the vehicle shall be equipped with a vehicle coastdown mode. The coastdown mode shall be approved by the responsible authority and its use shall be included in all relevant test reports.

If a vehicle is equipped with a vehicle coastdown mode, it shall be engaged both during road load determination and on the chassis dynamometer.
 - 7.3.3. Vehicle placement on the dynamometer

The tested vehicle shall be placed on the chassis dynamometer in a straight ahead position and restrained in a safe manner.

- 7.3.3.1. In the case that a single roller chassis dynamometer is used, the vehicle shall be positioned and stay positioned throughout the procedure according to the requirements in 7.3.3.1.1. to 7.3.3.1.3.
 - 7.3.3.1.1. Rotational alignment (rotation around z-axis)

The vehicle shall be positioned in line with the x-axis in order to minimise rotation around the z-axis
 - 7.3.3.1.2. Lateral position (y-axis)

The vehicle shall remain aligned in the y-direction and lateral movement shall be minimised.
 - 7.3.3.1.3. Front and rear position (x-axis)

For all rotating wheels the centre of the tyre’s contact patch on the roller shall be within ± 25 mm or ± 2 per cent of the roller diameter, whichever is smaller, from the top of the roller.
 - 7.3.3.1.4. The tested vehicle shall be restrained with a system compliant with paragraph 2.3.2. of Annex B5 .

If the torque meter method is used, the tyre pressure shall be adjusted such that the dynamic radius is within 0.5 per cent of the dynamic radius r_j calculated using the equations in paragraph 4.4.3.1. of this annex at the 80 km/h reference speed point. The dynamic radius on the chassis dynamometer shall be calculated according to the procedure described in paragraph 4.4.3.1. of this annex.

If this adjustment is outside the range defined in paragraph 7.3.1. of this annex, the torque meter method shall not apply.
- 7.3.4. Vehicle warm-up
 - 7.3.4.1. The vehicle shall be warmed up with the applicable WLTC. In the case that the vehicle was warmed up at 90 per cent of the maximum speed of the next higher phase during the procedure defined in paragraph 4.2.4.1.2. of this annex, this higher phase shall be added to the applicable WLTC.

Table A4/7
Vehicle warm-up

<i>Vehicle class</i>	<i>Applicable WLTC</i>	<i>Adopt next higher phase</i>	<i>Warm-up cycle</i>
Class 1	Low ₁ + Medium ₁	NA	Low ₁ + Medium ₁
Class 2	Low ₂ + Medium ₂ + High ₂ + Extra High ₂	NA	Low ₂ + Medium ₂ + High ₂ + Extra High ₂
	Low ₂ + Medium ₂ + High ₂	Yes (Extra High ₂)	Low ₂ + Medium ₂ + High ₂
Class 3	Low ₃ + Medium ₃ + High ₃ + Extra High ₃	No	
		Yes (Extra High ₃)	Low ₃ + Medium ₃ + High ₃ + Extra High ₃
	Low ₃ + Medium ₃ + High ₃	No	Low ₃ + Medium ₃ + High ₃

- 7.3.4.2. If the vehicle is already warmed up, the WLTC phase applied in paragraph 7.3.4.1. of this annex, with the highest speed, shall be driven.
- 7.3.4.3. Alternative warm-up procedure
 - 7.3.4.3.1. At the request of the vehicle manufacturer and with approval of the responsible authority, an alternative warm-up procedure may be used. The approved alternative warm-up procedure may be used for vehicles within the same road load family and shall satisfy the requirements outlined in paragraphs 7.3.4.3.2. to 7.3.4.3.5. inclusive of this annex.

- 7.3.4.3.2. At least one vehicle representing the road load family shall be selected.
- 7.3.4.3.3. The cycle energy demand calculated according to paragraph 5. of Annex B7 with corrected road load coefficients f_{0a} , f_{1a} and f_{2a} , for the alternative warm-up procedure shall be equal to or higher than the cycle energy demand calculated with the target road load coefficients f_0 , f_1 , and f_2 , for each applicable phase.

The corrected road load coefficients f_{0a} , f_{1a} and f_{2a} , shall be calculated according to the following equations:

$$f_{0a} = f_0 + A_{d_alt} - A_{d_WLTC}$$

$$f_{1a} = f_1 + B_{d_alt} - B_{d_WLTC}$$

$$f_{2a} = f_2 + C_{d_alt} - C_{d_WLTC}$$

where:

A_{d_alt} , B_{d_alt} and C_{d_alt} are the chassis dynamometer setting coefficients after the alternative warm-up procedure;

A_{d_WLTC} , B_{d_WLTC}

and C_{d_WLTC} are the chassis dynamometer setting coefficients after a WLTC warm-up procedure described in paragraph 7.3.4.1. of this annex and a valid chassis dynamometer load setting according to paragraph 8. of this annex.

- 7.3.4.3.4. The corrected road load coefficients f_{0a} , f_{1a} and f_{2a} , shall be used only for the purpose of paragraph 7.3.4.3.3. of this annex. For other purposes, the target road load coefficients f_0 , f_1 and f_2 , shall be used as the target road load coefficients.
- 7.3.4.3.5. Details of the procedure and of its equivalency shall be provided to the responsible authority.

8. Chassis dynamometer load setting

8.1. Chassis dynamometer load setting using the coastdown method

This method is applicable when the road load coefficients f_0 , f_1 and f_2 have been determined.

In the case of a road load matrix family, this method shall be applied when the road load of the representative vehicle is determined using the coastdown method described in paragraph 4.3. of this annex. The target road load values are the values calculated using the method described in paragraph 5.1. of this annex.

8.1.1. Initial load setting

For a chassis dynamometer with coefficient control, the chassis dynamometer power absorption unit shall be adjusted with the arbitrary initial coefficients, A_d , B_d and C_d , of the following equation:

$$F_d = A_d + B_d v + C_d v^2$$

where:

F_d is the chassis dynamometer setting load, N;

v is the speed of the chassis dynamometer roller, km/h.

The following are recommended coefficients to be used for the initial load setting:

(a) $A_d = 0.5 \times A_t$, $B_d = 0.2 \times B_t$, $C_d = C_t$

for single-axis chassis dynamometers, or

$$A_d = 0.1 \times A_t, B_d = 0.2 \times B_t, C_d = C_t$$

for dual-axis chassis dynamometers, where A_t , B_t and C_t are the target road load coefficients;

- (b) Empirical values, such as those used for the setting for a similar type of vehicle.

For a chassis dynamometer of polygonal control, adequate load values at each reference speed shall be set to the chassis dynamometer power absorption unit.

8.1.2. Coastdown

The coastdown test on the chassis dynamometer shall be performed with the procedure given in paragraphs 8.1.3.4.1. or 8.1.3.4.2. of this annex and shall start no later than 120 seconds after completion of the warm-up procedure. Consecutive coastdown runs shall be started immediately. At the request of the manufacturer and with approval of the responsible authority, the time between the warm-up procedure and coastdowns using the iterative method may be extended to ensure a proper vehicle setting for the coastdown. The manufacturer shall provide the responsible authority with evidence for requiring additional time and evidence that the chassis dynamometer load setting parameters (e.g. coolant and/or oil temperature, force on a dynamometer) are not affected.

8.1.3. Verification

- 8.1.3.1. The target road load value shall be calculated using the target road load coefficient, A_t , B_t and C_t , for each reference speed, v_j :

$$F_{tj} = A_t + B_t v_j + C_t v_j^2$$

where:

A_t , B_t and C_t are the target road load parameters;

F_{tj} is the target road load at reference speed v_j , N;

v_j is the j^{th} reference speed, km/h.

- 8.1.3.2. The measured road load shall be calculated using the following equation:

$$F_{mj} = \frac{1}{3.6} \times (TM + m_r) \times \frac{2 \times \Delta v}{\Delta t_j}$$

where:

Δv is 5 km/h;

F_{mj} is the measured road load for each reference speed v_j , N;

TM is the test mass of the vehicle, kg;

m_r is the equivalent effective mass of rotating components according to paragraph 2.5.1. of this annex, kg;

Δt_j is the coastdown time corresponding to speed v_j , s.

- 8.1.3.3. The coefficients A_s , B_s and C_s in the road load equation of the simulated road load on the chassis dynamometer shall be calculated using a least squares regression analysis:

$$F_s = A_s + (B_s \times v) + (C_s \times v^2)$$

The simulated road load for each reference speed v_j shall be determined using the following equation, using the calculated A_s , B_s and C_s :

$$F_{sj} = A_s + (B_s \times v_j) + (C_s \times v_j^2)$$

- 8.1.3.4. For dynamometer load setting, two different methods may be used. If the vehicle is accelerated by the dynamometer, the methods described in

paragraph 8.1.3.4.1. of this annex shall be used. If the vehicle is accelerated under its own power, the methods in paragraphs 8.1.3.4.1. or 8.1.3.4.2. of this annex shall be used and the minimum acceleration multiplied by speed shall be $6 \text{ m}^2/\text{sec}^3$. Vehicles which are unable to achieve $6 \text{ m}^2/\text{s}^3$ shall be driven with the acceleration control fully applied.

8.1.3.4.1. Fixed run method

8.1.3.4.1.1. The dynamometer software shall perform a total of four coastdowns. From the first coastdown, the dynamometer setting coefficients for the second run shall be calculated according to paragraph 8.1.4. of this annex. Following the first coastdown, the software shall perform three additional coastdowns with either the fixed dynamometer setting coefficients determined after the first coastdown or the adjusted dynamometer setting coefficients according to paragraph 8.1.4. of this annex.

8.1.3.4.1.2. The final dynamometer setting coefficients A, B and C shall be calculated using the following equations:

$$A = A_t - \frac{\sum_{n=2}^4 (A_{s_n} - A_{d_n})}{3}$$

$$B = B_t - \frac{\sum_{n=2}^4 (B_{s_n} - B_{d_n})}{3}$$

$$C = C_t - \frac{\sum_{n=2}^4 (C_{s_n} - C_{d_n})}{3}$$

where:

A_t , B_t and C_t are the target road load parameters;

A_{s_n} , B_{s_n} and C_{s_n} are the simulated road load coefficients of the n^{th} run;

A_{d_n} , B_{d_n} and C_{d_n} are the dynamometer setting coefficients of the n^{th} run;

n is the index number of coastdowns including the first stabilisation run.

8.1.3.4.2. Iterative method

The calculated forces in the specified speed ranges shall either be within $\pm 10 \text{ N}$ after a least squares regression of the forces for two consecutive coastdowns when compared with the target values, or additional coastdowns shall be performed after adjusting the chassis dynamometer load setting according to paragraph 8.1.4. of this annex until the tolerance is satisfied.

8.1.4. Adjustment

The chassis dynamometer setting load shall be adjusted according to the following equations:

$$\begin{aligned} F_{dj}^* &= F_{dj} - F_j = F_{dj} - F_{sj} + F_{tj} \\ &= (A_d + B_d v_j + C_d v_j^2) - (A_s + B_s v_j + C_s v_j^2) + (A_t + B_t v_j + C_t v_j^2) \\ &= (A_d + A_t - A_s) + (B_d + B_t - B_s) v_j + (C_d + C_t - C_s) v_j^2 \end{aligned}$$

Therefore:

$$A_d^* = A_d + A_t - A_s$$

$$B_d^* = B_d + B_t - B_s$$

$$C_d^* = C_d + C_t - C_s$$

where:

F_{dj} is the initial chassis dynamometer setting load, N;

F_{dj}^* is the adjusted chassis dynamometer setting load, N;

- F_j is the adjustment road load equal to $(F_{sj} - F_{tj})$, N;
 F_{sj} is the simulated road load at reference speed v_j , N;
 F_{tj} is the target road load at reference speed v_j , N;
 A_d^* , B_d^* and C_d^* are the new chassis dynamometer setting coefficients.

8.1.5. A_t , B_t and C_t shall be used as the final values of f_0 , f_1 and f_2 , and shall be used for the following purposes:

- (a) Determination of downscaling, paragraph 8. of Annex B1;
- (b) Determination of gearshift points, Annex B2;
- (c) Interpolation of CO₂ and fuel consumption, paragraph 3.2.3. of Annex B7;
- (d) Calculation of results of electric and hybrid-electric vehicles, paragraph 4. of Annex B8.

8.2. Chassis dynamometer load setting using the torque meter method

This method is applicable when the running resistance is determined using the torque meter method described in paragraph 4.4. of this annex.

In the case of a road load matrix family, this method shall be applied when the running resistance of the representative vehicle is determined using the torque meter method as specified in paragraph 4.4. of this annex. The target running resistance values are the values calculated using the method specified in paragraph 5.1. of this annex.

8.2.1. Initial load setting

For a chassis dynamometer of coefficient control, the chassis dynamometer power absorption unit shall be adjusted with the arbitrary initial coefficients, A_d , B_d and C_d , of the following equation:

$$F_d = A_d + B_d v + C_d v^2$$

where:

- F_d is the chassis dynamometer setting load, N;
 v is the speed of the chassis dynamometer roller, km/h.

The following coefficients are recommended for the initial load setting:

$$(a) \quad A_d = 0.5 \times \frac{a_t}{r'}, B_d = 0.2 \times \frac{b_t}{r'}, C_d = \frac{c_t}{r'}$$

For single-axis chassis dynamometers, or

$$A_d = 0.1 \times \frac{a_t}{r'}, B_d = 0.2 \times \frac{b_t}{r'}, C_d = \frac{c_t}{r'}$$

For dual-axis chassis dynamometers, where:

a_t , b_t and c_t are the target running resistance coefficients; and

r' is the dynamic radius of the tyre on the chassis dynamometer obtained at 80 km/h, m, or

- (b) Empirical values, such as those used for the setting for a similar type of vehicle.

For a chassis dynamometer of polygonal control, adequate load values at each reference speed shall be set for the chassis dynamometer power absorption unit.

8.2.2. Wheel torque measurement

The torque measurement test on the chassis dynamometer shall be performed with the procedure defined in paragraph 4.4.2. of this annex. The torque meter(s) shall be identical to the one(s) used in the preceding road test.

8.2.3. Verification

8.2.3.1. The target running resistance (torque) curve shall be determined using the equation in paragraph 4.5.5.2.1. of this annex and may be written as follows:

$$C_t^* = a_t + b_t \times v_j + c_t \times v_j^2$$

8.2.3.2. The simulated running resistance (torque) curve on the chassis dynamometer shall be calculated according to the method described and the measurement precision specified in paragraph 4.4.3.2. of this annex, and the running resistance (torque) curve determination as described in paragraph 4.4.4. of this annex with applicable corrections according to paragraph 4.5. of this annex, all with the exception of measuring in opposite directions, resulting in a simulated running resistance curve:

$$C_s^* = C_{0s} + C_{1s} \times v_j + C_{2s} \times v_j^2$$

The simulated running resistance (torque) shall be within a tolerance of $\pm 10 N \times r'$ from the target running resistance at every speed reference point where r' is the dynamic radius of the tyre in metres on the chassis dynamometer obtained at 80 km/h.

If the tolerance at any reference speed does not satisfy the criterion of the method described in this paragraph, the procedure specified in paragraph 8.2.3.3. of this annex shall be used to adjust the chassis dynamometer load setting.

8.2.3.3. Adjustment

The chassis dynamometer load setting shall be adjusted using the following equation:

$$\begin{aligned} F_{dj}^* &= F_{dj} - \frac{F_{ej}}{r'} = F_{dj} - \frac{F_{sj}}{r'} + \frac{F_{tj}}{r'} \\ &= (A_d + B_d v_j + C_d v_j^2) - \frac{(a_s + b_s v_j + c_s v_j^2)}{r'} + \frac{(a_t + b_t v_j + c_t v_j^2)}{r'} \\ &= \left\{ A_d + \frac{(a_t - a_s)}{r'} \right\} + \left\{ B_d + \frac{(b_t - b_s)}{r'} \right\} v_j + \left\{ C_d + \frac{(c_t - c_s)}{r'} \right\} v_j^2 \end{aligned}$$

therefore:

$$\begin{aligned} A_d^* &= A_d + \frac{a_t - a_s}{r'} \\ B_d^* &= B_d + \frac{b_t - b_s}{r'} \\ C_d^* &= C_d + \frac{c_t - c_s}{r'} \end{aligned}$$

where:

- F_{dj}^* is the new chassis dynamometer setting load, N;
- F_{ej} is the adjustment road load equal to $(F_{sj} - F_{tj})$, Nm;
- F_{sj} is the simulated road load at reference speed v_j , Nm;
- F_{tj} is the target road load at reference speed v_j , Nm;
- A_d^* , B_d^* and C_d^* are the new chassis dynamometer setting coefficients;

r' is the dynamic radius of the tyre on the chassis dynamometer obtained at 80 km/h, m.

Paragraphs 8.2.2. and 8.2.3. of this annex shall be repeated until the tolerance in paragraph 8.2.3.2. of this annex is met.

8.2.3.4. The mass of the driven axle(s), tyre specifications and chassis dynamometer load setting shall be recorded when the requirement of paragraph 8.2.3.2. of this annex is fulfilled.

8.2.4. Transforming running resistance coefficients to road load coefficients f_0 , f_1 , f_2

8.2.4.1. If the vehicle does not coast down in a repeatable manner and a vehicle coastdown mode according to paragraph 4.2.1.8.5. of this annex is not feasible, the coefficients f_0 , f_1 and f_2 in the road load equation shall be calculated using the equations in paragraph 8.2.4.1.1. of this annex. In any other case, the procedure described in paragraphs 8.2.4.2. to 8.2.4.4. inclusive of this annex shall be performed.

8.2.4.1.1.
$$f_0 = \frac{c_0}{r} \times 1.02$$

$$f_1 = \frac{c_1}{r} \times 1.02$$

$$f_2 = \frac{c_2}{r} \times 1.02$$

where:

c_0 , c_1 , c_2 are the running resistance coefficients determined in paragraph 4.4.4. of this annex, Nm, Nm/(km/h), Nm/(km/h)²;

r is the dynamic tyre radius of the vehicle with which the running resistance was determined, m;

1.02 is an approximate coefficient compensating for drivetrain losses.

8.2.4.1.2. The determined f_0 , f_1 , f_2 values shall not be used for a chassis dynamometer setting or any emission or range testing. They shall be used only in the following cases:

- (a) Determination of downscaling, paragraph 8. of Annex B1;
- (b) Determination of gearshift points, Annex B2;
- (c) Interpolation of CO₂ and fuel consumption, paragraph 3.2.3 of Annex B7;
- (d) Calculation of results of electric and hybrid-electric vehicles, paragraph 4. of Annex B8.

8.2.4.2. Once the chassis dynamometer has been set within the specified tolerances, a vehicle coastdown procedure shall be performed on the chassis dynamometer as outlined in paragraph 4.3.1.3. of this annex. The coastdown times shall be recorded.

8.2.4.3. The road load F_j at reference speed v_j , N, shall be determined using the following equation:

$$F_j = \frac{1}{3.6} \times (TM + m_r) \times \frac{2 \times \Delta v}{\Delta t_j}$$

where:

F_j is the road load at reference speed v_j , N;

TM is the test mass of the vehicle, kg;

m_r is the equivalent effective mass of rotating components according to paragraph 2.5.1. of this annex, kg;

$\Delta v = 5 \text{ km/h}$

Δt_j is the coastdown time corresponding to speed v_j , s.

- 8.2.4.4. The coefficients f_0 , f_1 and f_2 in the road load equation shall be calculated with a least squares regression analysis over the reference speed range.

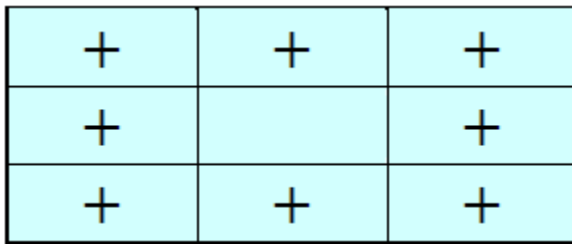
Annex B5

Test equipment and calibrations

1. Test bench specifications and settings
 - 1.1. Cooling fan specifications
 - 1.1.1. A variable speed current of air shall be blown towards the vehicle. The set point of the linear velocity of the air at the blower outlet shall be equal to the corresponding roller speed above roller speeds of 5 km/h. The linear velocity of the air at the blower outlet shall be within ± 5 km/h or ± 10 per cent of the corresponding roller speed, whichever is greater.
 - 1.1.2. The above-mentioned air velocity shall be determined as an averaged value of a number of measuring points that:
 - (a) For fans with rectangular outlets, are located at the centre of each rectangle dividing the whole of the fan outlet into 9 areas (dividing both horizontal and vertical sides of the fan outlet into 3 equal parts). The centre area shall not be measured (as shown in Figure A5/1);

Figure A5/1

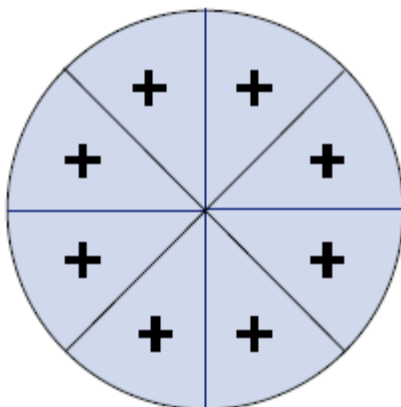
Fan with rectangular outlet



- (b) For fans with circular outlets, the outlet shall be divided into 8 equal sectors by vertical, horizontal and 45° lines. The measurement points shall lie on the radial centre line of each sector (22.5°) at two-thirds of the outlet radius (as shown in Figure A5/2).

Figure A5/2

Fan with circular outlet



These measurements shall be made with no vehicle or other obstruction in front of the fan. The device used to measure the linear velocity of the air shall be located between 0 and 20 cm from the air outlet.

- 1.1.3. The outlet of the fan shall have the following characteristics:
 - (a) An area of at least 0.3 m^2 ; and
 - (b) A width/diameter of at least 0.8 metre.

- 1.1.4. The position of the fan shall be as follows:
- (a) Height of the lower edge above ground: approximately 20 cm;
 - (b) Distance from the front of the vehicle: approximately 30 cm;
 - (c) Approximately on the longitudinal centreline of the vehicle.
- 1.1.5. At the request of the manufacturer and if considered appropriate by the responsible authority, the height, lateral position and distance from the vehicle of the cooling fan may be modified.
- If the specified fan configuration is impractical for special vehicle designs, such as vehicles with rear-mounted engines or side air intakes, or it does not provide adequate cooling to properly represent in-use operation, at the request of the manufacturer and if considered appropriate by the responsible authority, the height, capacity, longitudinal and lateral position of the cooling fan may be modified and additional fans which may have different specifications (including constant speed fans) may be used.
- 1.1.6. In the cases described in paragraph 1.1.5. of this annex, the position and capacity of the cooling fan(s) and details of the justification supplied to the responsible authority shall be recorded. For any subsequent testing, similar positions and specifications shall be used in consideration of the justification to avoid non-representative cooling characteristics.
2. Chassis dynamometer
- 2.1. General requirements
- 2.1.1. The dynamometer shall be capable of simulating road load with three road load coefficients that can be adjusted to shape the load curve.
- 2.1.2. The chassis dynamometer may have a single or twin-roller configuration. In the case that twin-roller chassis dynamometers are used, the rollers shall be permanently coupled or the front roller shall drive, directly or indirectly, any inertial masses and the power absorption device.
- 2.2. Specific requirements
- The following specific requirements relate to the dynamometer manufacturer's specifications.
- 2.2.1. The roller run-out shall be less than 0.25 mm at all measured locations.
- 2.2.2. The roller diameter shall be within ± 1.0 mm of the specified nominal value at all measurement locations.
- 2.2.3. The dynamometer shall have a time measurement system for use in determining acceleration rates and for measuring vehicle/dynamometer coastdown times. This time measurement system shall not exceed an accuracy of ± 0.001 per cent after at least 1,000 seconds of operation. This shall be verified upon initial installation.
- 2.2.4. The dynamometer shall have a speed measurement system with an accuracy of at least ± 0.080 km/h. This shall be verified upon initial installation.
- 2.2.5. The dynamometer shall have a response time (90 per cent response to a tractive effort step change) of less than 100 ms with instantaneous accelerations that are at least 3 m/s^2 . This shall be verified upon initial installation and after major maintenance.
- 2.2.6. The base inertia of the dynamometer shall be stated by the dynamometer manufacturer and shall be confirmed to within 0.5 per cent or 7.5 kg whichever is the greater for each measured base inertia and ± 0.2 per cent relative to any arithmetic average value by dynamic derivation from trials at constant acceleration, deceleration and force.
- 2.2.7. Roller speed shall be measured at a frequency of not less than 10 Hz.

- 2.3. Additional specific requirements for a chassis dynamometer in 4WD operation
- 2.3.1. For testing in 4WD operation, the chassis dynamometer shall have a single roller configuration. The 4WD control system shall be designed such that the following requirements are fulfilled when tested with a vehicle driven over the WLTC.
- 2.3.1.1. Road load simulation shall be applied such that the dynamometer in 4WD operation reproduces the same proportioning of forces as would be encountered when driving the vehicle on a smooth, dry, level road surface.
- 2.3.1.2. Upon initial installation and after major maintenance, the requirements of paragraph 2.3.1.2.1. of this annex and of either paragraph 2.3.1.2.2. or 2.3.1.2.3. of this annex shall be satisfied. The speed difference between the front and rear rollers shall be assessed by applying a 1 second moving average filter to roller speed data acquired at a minimum frequency of 20 Hz.
- 2.3.1.2.1. The difference in distance covered by the front and rear rollers shall be less than 0.2 per cent of the distance driven over the WLTC. The absolute number shall be integrated for the calculation of the total difference in distance over the WLTC.
- 2.3.1.2.2. The difference in distance covered by the front and rear rollers shall be less than 0.1 m in any 200 ms time period.
- 2.3.1.2.3. The speed difference of all roller speeds shall be within ± 0.16 km/h.
- 2.3.2. Vehicle restraint system for single roller chassis dynamometers
- 2.3.2.1. Vertical force
- In addition to the requirement of paragraph 7.3.3.1.3. of Annex B4, the restraint system shall be designed so that the vertical force imposed to the vehicle is minimised and is the same during the chassis dynamometer setting and all tests. This criteria is fulfilled, if either the restraint system is designed such that it cannot impose any different vertical force, or if a procedure to demonstrate how this requirement can be met is agreed between the responsible authority and the manufacturer.
- 2.3.2.2. Restraint stiffness
- The restraint system shall exhibit sufficient stiffness in order to minimize any movements and rotations. Only limited movements along the z-axis and rotations over the y-axis are allowed to avoid non-negligible effects towards the test results and to fulfil the requirements of paragraph 2.3.2.1. of this annex.
- 2.4. Chassis dynamometer calibration
- 2.4.1. Force measurement system
- The accuracy of the force transducer shall be at least ± 10 N for all measured increments. This shall be verified upon initial installation, after major maintenance and within 370 days before testing.
- 2.4.2. Dynamometer parasitic loss calibration
- The dynamometer's parasitic losses shall be measured and updated if any measured value differs from the current loss curve by more than 9.0 N. This shall be verified upon initial installation, after major maintenance and within 35 days before testing.
- 2.4.3. Verification of road load simulation without a vehicle
- The dynamometer performance shall be verified by performing an unloaded coastdown test upon initial installation, after major maintenance, and within 7 days before testing. The arithmetic average coastdown force error shall be less than 10 N or 2 per cent, whichever is greater, at each reference speed point.

3. Exhaust gas dilution system
 - 3.1. System specification
 - 3.1.1. Overview
 - 3.1.1.1. A full flow exhaust dilution system shall be used. The total vehicle exhaust shall be continuously diluted with ambient air under controlled conditions using a constant volume sampler. A critical flow venturi (CFV) or multiple critical flow venturis arranged in parallel, a positive displacement pump (PDP), a subsonic venturi (SSV), or an ultrasonic flow meter (UFM) may be used. The total volume of the mixture of exhaust and dilution air shall be measured and a continuously proportional sample of the volume shall be collected for analysis. The quantities of exhaust gas compounds shall be determined from the sample concentrations, corrected for their respective content of the dilution air and the totalised flow over the test period.
 - 3.1.1.2. The exhaust dilution system shall consist of a connecting tube, a mixing device and dilution tunnel, dilution air conditioning, a suction device and a flow measurement device. Sampling probes shall be fitted in the dilution tunnel as specified in paragraphs 4.1., 4.2. and 4.3. of this annex.
 - 3.1.1.3. The mixing device referred to in paragraph 3.1.1.2. of this annex shall be a vessel such as that illustrated in Figure A5/3 in which vehicle exhaust gases and the dilution air are combined so as to produce a homogeneous mixture at the sampling position.
 - 3.2. General requirements
 - 3.2.1. The vehicle exhaust gases shall be diluted with a sufficient amount of ambient air to prevent any water condensation in the sampling and measuring system at all conditions that may occur during a test.
 - 3.2.2. The mixture of air and exhaust gases shall be homogeneous at the point where the sampling probes are located (see paragraph 3.3.3. of this annex). The sampling probes shall extract representative samples of the diluted exhaust gas.
 - 3.2.3. The system shall enable the total volume of the diluted exhaust gases to be measured.
 - 3.2.4. The sampling system shall be gas-tight. The design of the variable dilution sampling system and the materials used in its construction shall be such that the concentration of any compound in the diluted exhaust gases is not affected. If any component in the system (heat exchanger, cyclone separator, suction device, etc.) changes the concentration of any of the exhaust gas compounds and the systematic error cannot be corrected, sampling for that compound shall be carried out upstream from that component.
 - 3.2.5. All parts of the dilution system in contact with raw or diluted exhaust gas shall be designed to minimise deposition or alteration of the particulate or particles. All parts shall be made of electrically conductive materials that do not react with exhaust gas components, and shall be electrically grounded to prevent electrostatic effects.
 - 3.2.6. If the vehicle being tested is equipped with an exhaust pipe comprising several branches, the connecting tubes shall be connected as near as possible to the vehicle without adversely affecting their operation.
 - 3.3. Specific requirements
 - 3.3.1. Connection to vehicle exhaust
 - 3.3.1.1. The start of the connecting tube is the exit of the tailpipe. The end of the connecting tube is the sample point, or first point of dilution.

For multiple tailpipe configurations where all the tailpipes are combined, the start of the connecting tube shall be taken at the last joint of where all the

tailpipes are combined. In this case, the tube between the exit of the tailpipe and the start of the connecting tube may or may not be insulated or heated.

- 3.3.1.2. The connecting tube between the vehicle and dilution system shall be designed so as to minimize heat loss.
- 3.3.1.3. The connecting tube shall satisfy the following requirements:
- (a) Be less than 3.6 metres long, or less than 6.1 metres long if heat-insulated. Its internal diameter shall not exceed 105 mm; the insulating materials shall have a thickness of at least 25 mm and thermal conductivity shall not exceed $0.1 \text{ W/m}^1\text{K}^{-1}$ at 400 °C. Optionally, the tube may be heated to a temperature above the dew point. This may be assumed to be achieved if the tube is heated to 70 °C;
 - (b) Not cause the static pressure at the exhaust outlets on the vehicle being tested to differ by more than $\pm 0.75 \text{ kPa}$ at 50 km/h, or more than $\pm 1.25 \text{ kPa}$ for the duration of the test from the static pressures recorded when nothing is connected to the vehicle exhaust pipes. The pressure shall be measured in the exhaust outlet or in an extension having the same diameter and as near as possible to the end of the tailpipe. Sampling systems capable of maintaining the static pressure to within $\pm 0.25 \text{ kPa}$ may be used if a written request from a manufacturer to the responsible authority substantiates the need for the tighter tolerance;
 - (c) No component of the connecting tube shall be of a material that might affect the gaseous or solid composition of the exhaust gas. To avoid generation of any particles from elastomer connectors, elastomers employed shall be as thermally stable as possible and have minimum exposure to the exhaust gas. It is recommended not to use elastomer connectors to bridge the connection between the vehicle exhaust and the connecting tube.
- 3.3.2. Dilution air conditioning
- 3.3.2.1. The dilution air used for the primary dilution of the exhaust in the CVS tunnel shall pass through a medium capable of reducing particles of the most penetrating particle size in the filter material by ≤ 99.95 per cent, or through a filter of at least Class H13 of EN 1822:2009. This represents the specification of High Efficiency Particulate Air (HEPA) filters. The dilution air may optionally be charcoal-scrubbed before being passed to the HEPA filter. It is recommended that an additional coarse particle filter be situated before the HEPA filter and after the charcoal scrubber, if used.
- 3.3.2.2. At the vehicle manufacturer's request, the dilution air may be sampled according to good engineering practice to determine the tunnel contribution to background particulate and, if PN measurement is required particle levels, which can be subsequently subtracted from the values measured in the diluted exhaust. See paragraph 2.1.3. of Annex B6.
- 3.3.3. Dilution tunnel
- 3.3.3.1. Provision shall be made for the vehicle exhaust gases and the dilution air to be mixed. A mixing device may be used.
- 3.3.3.2. The homogeneity of the mixture in any cross-section at the location of the sampling probe shall not vary by more than ± 2 per cent from the arithmetic average of the values obtained for at least five points located at equal intervals on the diameter of the gas stream.
- 3.3.3.3. For PM and PN (if PN measurement is required) emissions sampling, a dilution tunnel shall be used that:
- (a) Consists of a straight tube of electrically-conductive material that is grounded;

- (b) Causes turbulent flow (Reynolds number $\geq 4,000$) and be of sufficient length to cause complete mixing of the exhaust and dilution air;
- (c) Is at least 200 mm in diameter;
- (d) May be insulated and/or heated.

3.3.4. Suction device

3.3.4.1. This device may have a range of fixed speeds to ensure sufficient flow to prevent any water condensation. This result is obtained if the flow is either:

- (a) Twice as high as the maximum flow of exhaust gas produced by accelerations of the driving cycle; or
- (b) Sufficient to ensure that the CO₂ concentration in the dilute exhaust sample bag is less than 3 per cent by volume for petrol and diesel, less than 2.2 per cent by volume for LPG and less than 1.5 per cent by volume for NG/biomethane.

3.3.4.2. Compliance with the requirements in paragraph 3.3.4.1. of this annex may not be necessary if the CVS system is designed to inhibit condensation by such techniques, or combination of techniques, as:

- (a) Reducing water content in the dilution air (dilution air dehumidification);
- (b) Heating of the CVS dilution air and of all components up to the diluted exhaust flow measurement device and, optionally, the bag sampling system including the sample bags and also the system for the measurement of the bag concentrations.

In such cases, the selection of the CVS flow rate for the test shall be justified by showing that condensation of water cannot occur at any point within the CVS, bag sampling or analytical system.

3.3.5. Volume measurement in the primary dilution system

3.3.5.1. The method of measuring total dilute exhaust volume incorporated in the constant volume sampler shall be such that measurement is accurate to ± 2 per cent under all operating conditions. If the device cannot compensate for variations in the temperature of the mixture of exhaust gases and dilution air at the measuring point, a heat exchanger shall be used to maintain the temperature to within ± 6 °C of the specified operating temperature for a PDP CVS, ± 11 °C for a CFV CVS, ± 6 °C for a UFM CVS, and ± 11 °C for an SSV CVS.

3.3.5.2. If necessary, some form of protection for the volume measuring device may be used e.g. a cyclone separator, bulk stream filter, etc.

3.3.5.3. A temperature sensor shall be installed immediately before the volume measuring device. This temperature sensor shall have an accuracy of ± 1 °C and a response time of 1 second or less at 62 per cent of a given temperature variation (value measured in water or silicone oil).

3.3.5.4. Measurement of the pressure difference from atmospheric pressure shall be taken upstream from and, if necessary, downstream from the volume measuring device.

3.3.5.5. The pressure measurements shall have a precision and an accuracy of ± 0.4 kPa during the test. See Table A5/5.

3.3.6. Recommended system description

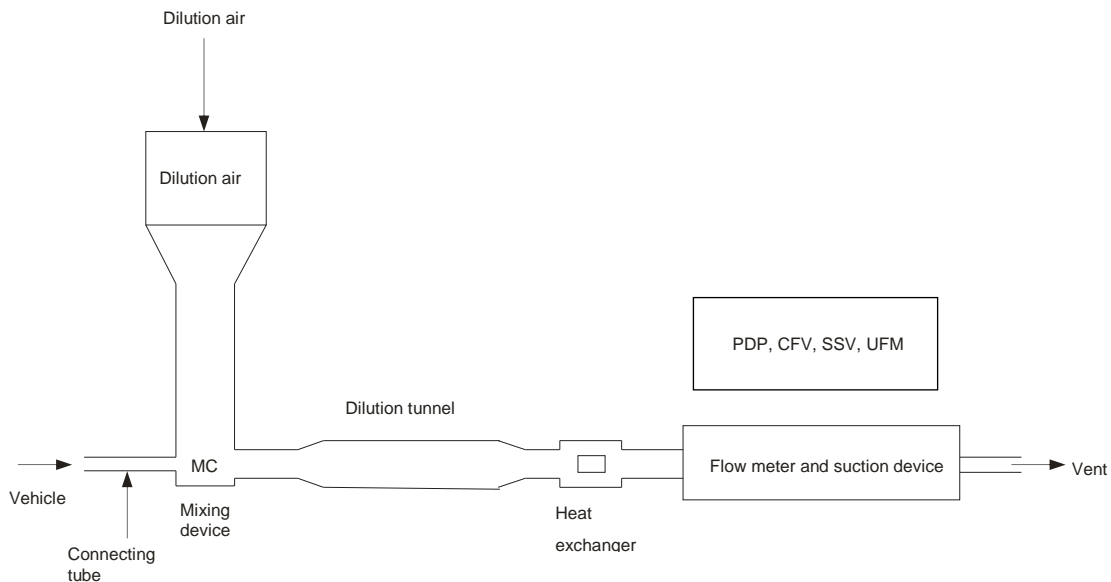
Figure A5/3 is a schematic drawing of exhaust dilution systems that meet the requirements of this annex.

The following components are recommended:

- (a) A dilution air filter, which may be pre-heated if necessary. This filter shall consist of the following filters in sequence: an optional activated charcoal filter (inlet side), and a HEPA filter (outlet side). It is recommended that an additional coarse particle filter be situated before the HEPA filter and after the charcoal filter, if used. The purpose of the charcoal filter is to reduce and stabilize the hydrocarbon concentrations of ambient emissions in the dilution air;
- (b) A connecting tube by which vehicle exhaust is admitted into a dilution tunnel;
- (c) An optional heat exchanger as described in paragraph 3.3.5.1. of this annex;
- (d) A mixing device in which exhaust gas and dilution air are mixed homogeneously, and which may be located close to the vehicle so that the length of the connecting tube is minimized;
- (e) A dilution tunnel from which particulate and, if applicable, particles are sampled;
- (f) Some form of protection for the measurement system may be used e.g. a cyclone separator, bulk stream filter, etc.;
- (g) A suction device of sufficient capacity to handle the total volume of diluted exhaust gas.

Exact conformity with these figures is not essential. Additional components such as instruments, valves, solenoids and switches may be used to provide additional information and co-ordinate the functions of the component system.

Figure A5/3
Exhaust dilution system



3.3.6.1. Positive displacement pump (PDP)

A positive displacement pump (PDP) full flow exhaust dilution system satisfies the requirements of this annex by metering the flow of gas through the pump at constant temperature and pressure. The total volume is measured by counting the revolutions made by the calibrated positive displacement pump. The proportional sample is achieved by sampling with pump, flow meter and flow control valve at a constant flow rate.

3.3.6.2. Critical flow venturi (CFV)

3.3.6.2.1. The use of a CFV for the full flow exhaust dilution system is based on the principles of flow mechanics for critical flow. The variable mixture flow rate of dilution and exhaust gas is maintained at sonic velocity that is directly proportional to the square root of the gas temperature. Flow is continually monitored, computed and integrated throughout the test.

3.3.6.2.2. The use of an additional critical flow sampling venturi ensures the proportionality of the gas samples taken from the dilution tunnel. As both pressure and temperature are equal at the two venturi inlets, the volume of the gas flow diverted for sampling is proportional to the total volume of diluted exhaust gas mixture produced, and thus the requirements of this annex are fulfilled.

3.3.6.2.3. A measuring CFV tube shall measure the flow volume of the diluted exhaust gas.

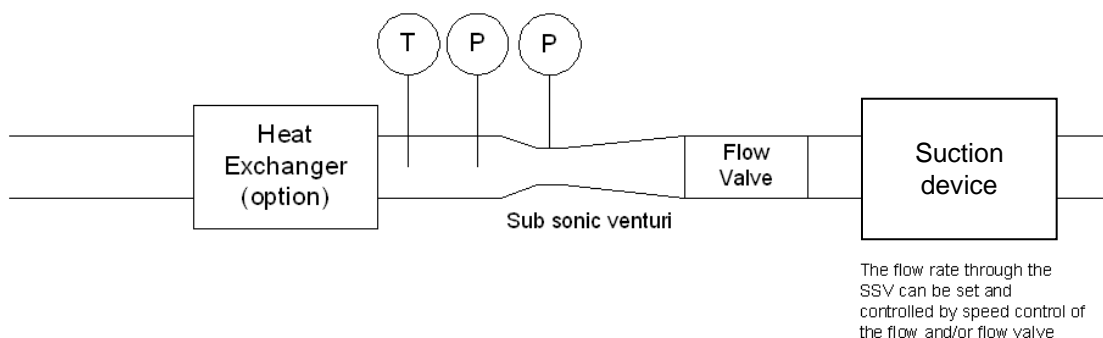
3.3.6.3. Subsonic flow venturi (SSV)

3.3.6.3.1. The use of an SSV (Figure A5/4) for a full flow exhaust dilution system is based on the principles of flow mechanics. The variable mixture flow rate of dilution and exhaust gas is maintained at a subsonic velocity that is calculated from the physical dimensions of the subsonic venturi and measurement of the absolute temperature (T) and pressure (P) at the venturi inlet and the pressure in the throat of the venturi. Flow is continually monitored, computed and integrated throughout the test.

3.3.6.3.2. An SSV shall measure the flow volume of the diluted exhaust gas.

Figure A5/4

Schematic of a subsonic venturi tube (SSV)



3.3.6.4. Ultrasonic flow meter (UFM)

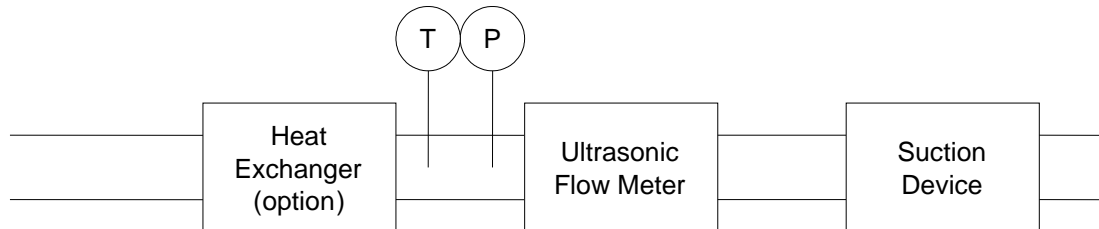
3.3.6.4.1. A UFM measures the velocity of the diluted exhaust gas in the CVS piping using the principle of ultrasonic flow detection by means of a pair, or multiple pairs, of ultrasonic transmitters/receivers mounted within the pipe as in Figure A5/5. The velocity of the flowing gas is determined by the difference in the time required for the ultrasonic signal to travel from transmitter to receiver in the upstream direction and the downstream direction. The gas velocity is converted to standard volumetric flow using a calibration factor for the tube diameter with real time corrections for the diluted exhaust temperature and absolute pressure.

3.3.6.4.2. Components of the system include:

- (a) A suction device fitted with speed control, flow valve or other method for setting the CVS flow rate and also for maintaining constant volumetric flow at standard conditions;
- (b) A UFM;
- (c) Temperature and pressure measurement devices, T and P, required for flow correction;

- (d) An optional heat exchanger for controlling the temperature of the diluted exhaust to the UFM. If installed, the heat exchanger shall be capable of controlling the temperature of the diluted exhaust to that specified in paragraph 3.3.5.1. of this annex. Throughout the test, the temperature of the air/exhaust gas mixture measured at a point immediately upstream of the suction device shall be within ± 6 °C of the arithmetic average operating temperature during the test.

Figure A5/5

Schematic of an ultrasonic flow meter (UFM)

3.3.6.4.3. The following conditions shall apply to the design and use of the UFM type CVS:

- (a) The velocity of the diluted exhaust gas shall provide a Reynolds number higher than 4,000 in order to maintain a consistent turbulent flow before the ultrasonic flow meter;
- (b) An ultrasonic flow meter shall be installed in a pipe of constant diameter with a length of 10 times the internal diameter upstream and 5 times the diameter downstream;
- (c) A temperature sensor (T) for the diluted exhaust shall be installed immediately before the ultrasonic flow meter. This sensor shall have an accuracy of ± 1 °C and a response time of 0.1 seconds at 62 per cent of a given temperature variation (value measured in silicone oil);
- (d) The absolute pressure (P) of the diluted exhaust shall be measured immediately before the ultrasonic flow meter to within ± 0.3 kPa;
- (e) If a heat exchanger is not installed upstream of the ultrasonic flow meter, the flow rate of the diluted exhaust, corrected to standard conditions, shall be maintained at a constant level during the test. This may be achieved by control of the suction device, flow valve or other method.

3.4. CVS calibration procedure

3.4.1. General requirements

3.4.1.1. The CVS system shall be calibrated by using an accurate flow meter and a restricting device and at the intervals listed in Table A5/4. The flow through the system shall be measured at various pressure readings and the control parameters of the system measured and related to the flows. The flow metering device (e.g. calibrated venturi, laminar flow element (LFE), calibrated turbine meter) shall be dynamic and suitable for the high flow rate encountered in constant volume sampler testing. The device shall be of certified accuracy.

3.4.1.2. The following paragraphs describe methods for calibrating PDP, CFV, SSV and UFM units using a laminar flow meter, which gives the required accuracy, along with a statistical check on the calibration validity.

3.4.2. Calibration of a positive displacement pump (PDP)

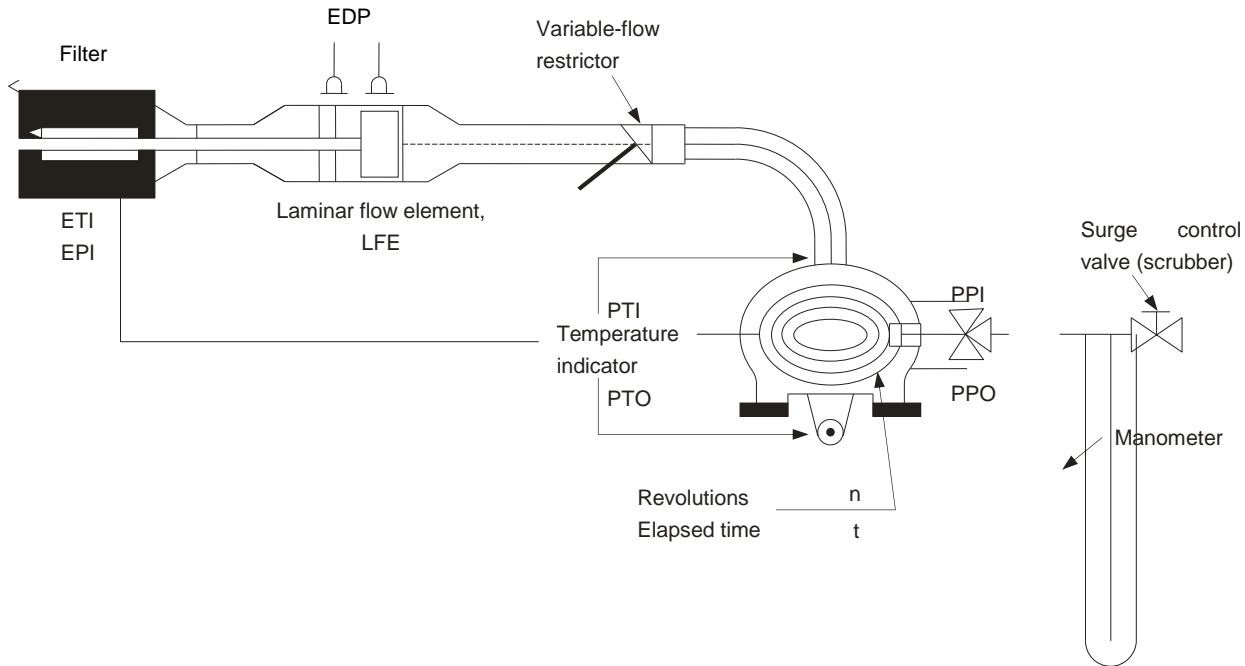
3.4.2.1. The following calibration procedure outlines the equipment, the test configuration and the various parameters that are measured to establish the flow rate of the CVS pump. All the parameters related to the pump are simultaneously measured with the parameters related to the flow meter that is

connected in series with the pump. The calculated flow rate (given in m^3/min at pump inlet for the measured absolute pressure and temperature) shall be subsequently plotted versus a correlation function that includes the relevant pump parameters. The linear equation that relates the pump flow and the correlation function shall be subsequently determined. In the case that a CVS has a multiple speed drive, a calibration for each range used shall be performed.

- 3.4.2.2. This calibration procedure is based on the measurement of the absolute values of the pump and flow meter parameters relating the flow rate at each point. The following conditions shall be maintained to ensure the accuracy and integrity of the calibration curve:
- 3.4.2.2.1. The pump pressures shall be measured at tapings on the pump rather than at the external piping on the pump inlet and outlet. Pressure taps that are mounted at the top centre and bottom centre of the pump drive head plate are exposed to the actual pump cavity pressures, and therefore reflect the absolute pressure differentials.
- 3.4.2.2.2. Temperature stability shall be maintained during the calibration. The laminar flow meter is sensitive to inlet temperature oscillations that cause data points to be scattered. Gradual changes of ± 1 °C in temperature are acceptable as long as they occur over a period of several minutes.
- 3.4.2.2.3. All connections between the flow meter and the CVS pump shall be free of leakage.
- 3.4.2.3. During an exhaust emissions test, the measured pump parameters shall be used to calculate the flow rate from the calibration equation.
- 3.4.2.4. Figure A5/6 of this annex shows an example of a calibration set-up. Variations are permissible, provided that the responsible authority approves them as being of comparable accuracy. If the set-up shown in Figure A5/6 is used, the following data shall be found within the limits of accuracy given:

Barometric pressure (corrected), P_b	± 0.03 kPa
Ambient temperature, T	± 0.2 °C
Air temperature at LFE, ETI	± 0.15 °C
Pressure depression upstream of LFE, EPI	± 0.01 kPa
Pressure drop across the LFE matrix, EDP	± 0.0015 kPa
Air temperature at CVS pump inlet, PTI	± 0.2 °C
Air temperature at CVS pump outlet, PTO	± 0.2 °C
Pressure depression at CVS pump inlet, PPI	± 0.22 kPa
Pressure head at CVS pump outlet, PPO	± 0.22 kPa
Pump revolutions during test period, n	± 1 min^{-1}
Elapsed time for period (minimum 250 s), t	± 0.1 s

Figure A5/6

PDP calibration configuration

- 3.4.2.5. After the system has been connected as shown in Figure A5/6, the variable restrictor shall be set in the wide-open position and the CVS pump shall run for 20 minutes before starting the calibration.
- 3.4.2.5.1. The restrictor valve shall be reset to a more restricted condition in increments of pump inlet depression (about 1 kPa) that will yield a minimum of six data points for the total calibration. The system shall be allowed to stabilize for 3 minutes before the data acquisition is repeated.
- 3.4.2.5.2. The air flow rate Q_s at each test point shall be calculated in standard m^3/min from the flow meter data using the manufacturer's prescribed method.
- 3.4.2.5.3. The air flow rate shall be subsequently converted to pump flow V_0 in m^3/rev at absolute pump inlet temperature and pressure.

$$V_0 = \frac{Q_s}{n} \times \frac{T_p}{273.15 \text{ K}} \times \frac{101.325 \text{ kPa}}{P_p}$$

where:

- V_0 is the pump flow rate at T_p and P_p , m^3/rev ;
- Q_s is the air flow at 101.325 kPa and 273.15 K (0 °C), m^3/min ;
- T_p is the pump inlet temperature, Kelvin (K);
- P_p is the absolute pump inlet pressure, kPa;
- n is the pump speed, min^{-1} .

- 3.4.2.5.4. To compensate for the interaction of pump speed pressure variations at the pump and the pump slip rate, the correlation function x_0 between the pump speed n , the pressure differential from pump inlet to pump outlet and the absolute pump outlet pressure shall be calculated using the following equation:

$$x_0 = \frac{1}{n} \sqrt{\frac{\Delta P_p}{P_e}}$$

where:

x_0 is the correlation function;

ΔP_p is the pressure differential from pump inlet to pump outlet, kPa;

P_e absolute outlet pressure ($PPO + P_b$), kPa.

A linear least squares fit shall be performed to generate the calibration equations having the following form:

$$V_0 = D_0 - M \times x_0$$

$$n = A - B \times \Delta P_p$$

where B and M are the slopes, and A and D_0 are the intercepts of the lines.

3.4.2.6. A CVS system having multiple speeds shall be calibrated at each speed used. The calibration curves generated for the ranges shall be approximately parallel and the intercept values D_0 shall increase as the pump flow range decreases.

3.4.2.7. The calculated values from the equation shall be within 0.5 per cent of the measured value of V_0 . Values of M will vary from one pump to another. A calibration shall be performed at initial installation and after major maintenance.

3.4.3. Calibration of a critical flow venturi (CFV)

3.4.3.1. Calibration of a CFV is based upon the flow equation for a critical venturi:

$$Q_s = \frac{K_v P}{\sqrt{T}}$$

where:

Q_s is the flow, m³/min;

K_v is the calibration coefficient;

P is the absolute pressure, kPa;

T is the absolute temperature, Kelvin (K).

Gas flow is a function of inlet pressure and temperature.

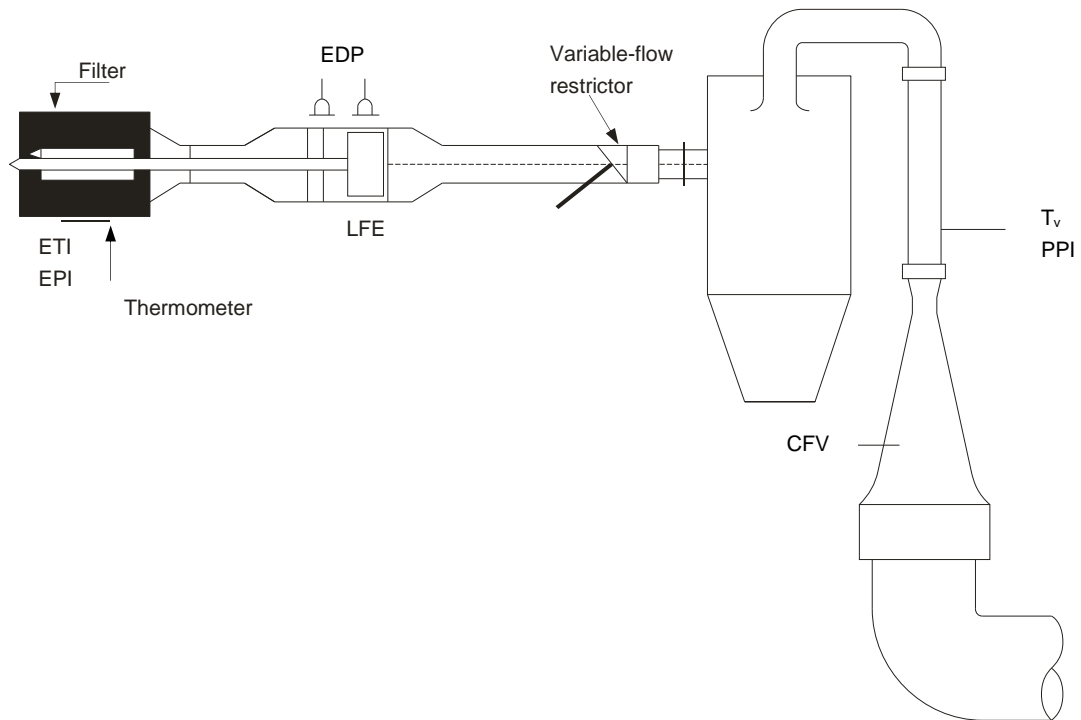
The calibration procedure described in paragraphs 3.4.3.2. to 3.4.3.3.4. inclusive of this annex establishes the value of the calibration coefficient at measured values of pressure, temperature and air flow.

3.4.3.2. Measurements for flow calibration of a critical flow venturi are required and the following data shall be within the limits of accuracy given:

Barometric pressure (corrected), P_b	± 0.03 kPa,
LFE air temperature, flow meter, ETI	± 0.15 °C,
Pressure depression upstream of LFE, EPI	± 0.01 kPa,
Pressure drop across LFE matrix, EDP	± 0.0015 kPa,
Air flow, Q_s	± 0.5 per cent,
CFV inlet depression, PPI	± 0.02 kPa,
Temperature at venturi inlet, T_v	± 0.2 °C.

3.4.3.3. The equipment shall be set up as shown in Figure A5/7 and checked for leaks. Any leaks between the flow-measuring device and the critical flow venturi will seriously affect the accuracy of the calibration and shall therefore be prevented.

Figure A5/7
CFV calibration configuration



- 3.4.3.3.1. The variable-flow restrictor shall be set to the open position, the suction device shall be started and the system stabilized. Data from all instruments shall be collected.
- 3.4.3.3.2. The flow restrictor shall be varied and at least eight readings across the critical flow range of the venturi shall be made.
- 3.4.3.3.3. The data recorded during the calibration shall be used in the following calculation:
- 3.4.3.3.3.1. The air flow rate Q_s at each test point shall be calculated from the flow meter data using the manufacturer's prescribed method.

Values of the calibration coefficient shall be calculated for each test point:

$$K_v = \frac{Q_s \sqrt{T_v}}{P_v}$$

where:

Q_s is the flow rate, m³/min at 273.15 K (0 °C) and 101.325, kPa;

T_v is the temperature at the venturi inlet, Kelvin (K);

P_v is the absolute pressure at the venturi inlet, kPa.

- 3.4.3.3.3.2. K_v shall be plotted as a function of venturi inlet pressure P_v . For sonic flow K_v will have a relatively constant value. As pressure decreases (vacuum increases), the venturi becomes unchoked and K_v decreases. These values of K_v shall not be used for further calculations.
- 3.4.3.3.3.3. For a minimum of eight points in the critical region, an arithmetic average K_v and the standard deviation shall be calculated.
- 3.4.3.3.3.4. If the standard deviation exceeds 0.3 per cent of the arithmetic average K_v , corrective action shall be taken.

- 3.4.4. Calibration of a subsonic venturi (SSV)
- 3.4.4.1. Calibration of the SSV is based upon the flow equation for a subsonic venturi. Gas flow is a function of inlet pressure and temperature, and the pressure drop between the SSV inlet and throat.
- 3.4.4.2. Data analysis
- 3.4.4.2.1. The airflow rate, Q_{SSV} , at each restriction setting (minimum 16 settings) shall be calculated in standard m^3/s from the flow meter data using the manufacturer's prescribed method. The discharge coefficient C_d shall be calculated from the calibration data for each setting using the following equation:

$$C_d = \frac{Q_{SSV}}{d_V^2 \times p_p \times \sqrt{\left\{ \frac{1}{T} \times (r_p^{1.426} - r_p^{1.713}) \times \left(\frac{1}{1 - r_D^4 \times r_p^{1.426}} \right) \right\}}}$$

where:

Q_{SSV} is the airflow rate at standard conditions (101.325 kPa, 273.15 K (0 °C)), m^3/s ;

T is the temperature at the venturi inlet, Kelvin (K);

d_V is the diameter of the SSV throat, m;

r_p is the ratio of the SSV throat pressure to inlet absolute static pressure, $1 - \frac{\Delta p}{p_p}$;

r_D is the ratio of the SSV throat diameter d_V to the inlet pipe inner diameter D ;

C_d is the discharge coefficient of the SSV;

p_p is the absolute pressure at venturi inlet, kPa.

To determine the range of subsonic flow, C_d shall be plotted as a function of Reynolds number Re at the SSV throat. The Reynolds number at the SSV throat shall be calculated using the following equation:

$$Re = A_1 \times \frac{Q_{SSV}}{d_V \times \mu}$$

where:

$$\mu = \frac{b \times T^{1.5}}{S + T}$$

A_1 is 25.55152 in SI, $\left(\frac{1}{m^3}\right) \left(\frac{min}{s}\right) \left(\frac{mm}{m}\right)$;

Q_{SSV} is the airflow rate at standard conditions (101.325 kPa, 273.15 K (0 °C)), m^3/s ;

d_V is the diameter of the SSV throat, m;

μ is the absolute or dynamic viscosity of the gas, kg/ms;

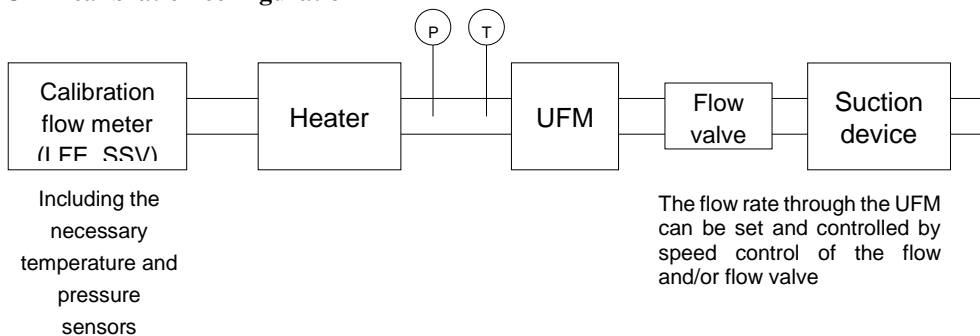
b is 1.458×10^6 (empirical constant), kg/ms $K^{0.5}$;

S is 110.4 (empirical constant), Kelvin (K).

- 3.4.4.2.2. Because Q_{SSV} is an input to the Re equation, the calculations shall be started with an initial estimate for Q_{SSV} or C_d of the calibration venturi, and repeated until Q_{SSV} converges. The convergence method shall be accurate to at least 0.1 per cent.

- 3.4.4.2.3. For a minimum of sixteen points in the region of subsonic flow, the calculated values of C_d from the resulting calibration curve fit equation shall be within ± 0.5 per cent of the measured C_d for each calibration point.
- 3.4.5. Calibration of an ultrasonic flow meter (UFM)
- 3.4.5.1. The UFM shall be calibrated against a suitable reference flow meter.
- 3.4.5.2. The UFM shall be calibrated in the CVS configuration that will be used in the test cell (diluted exhaust piping, suction device) and checked for leaks. See Figure A5/8.
- 3.4.5.3. A heater shall be installed to condition the calibration flow in the event that the UFM system does not include a heat exchanger.
- 3.4.5.4. For each CVS flow setting that will be used, the calibration shall be performed at temperatures from room temperature to the maximum that will be experienced during vehicle testing.
- 3.4.5.5. The manufacturer's recommended procedure shall be followed for calibrating the electronic portions (temperature (T) and pressure (P) sensors) of the UFM.
- 3.4.5.6. Measurements for flow calibration of the ultrasonic flow meter are required and the following data (in the case that a laminar flow element is used) shall be found within the limits of accuracy given:
- | | |
|--|---------------------|
| Barometric pressure (corrected), P_b | ± 0.03 kPa, |
| LFE air temperature, flow meter, ETI | ± 0.15 °C, |
| Pressure depression upstream of LFE, EPI | ± 0.01 kPa, |
| Pressure drop across (EDP) LFE matrix | ± 0.0015 kPa, |
| Air flow, Q_s | ± 0.5 per cent, |
| UFM inlet depression, P_{act} | ± 0.02 kPa, |
| Temperature at UFM inlet, T_{act} | ± 0.2 °C. |
- 3.4.5.7. Procedure
- 3.4.5.7.1. The equipment shall be set up as shown in Figure A5/8 and checked for leaks. Any leaks between the flow-measuring device and the UFM will seriously affect the accuracy of the calibration.

Figure A5/8
UFM calibration configuration



- 3.4.5.7.2. The suction device shall be started. Its speed and/or the position of the flow valve shall be adjusted to provide the set flow for the validation and the system stabilised. Data from all instruments shall be collected.
- 3.4.5.7.3. For UFM systems without a heat exchanger, the heater shall be operated to increase the temperature of the calibration air, allowed to stabilise and data from all the instruments recorded. The temperature shall be increased in reasonable steps until the maximum expected diluted exhaust temperature expected during the emissions test is reached.

- 3.4.5.7.4. The heater shall be subsequently turned off and the suction device speed and/or flow valve shall be adjusted to the next flow setting that will be used for vehicle emissions testing after which the calibration sequence shall be repeated.
- 3.4.5.8. The data recorded during the calibration shall be used in the following calculations. The air flow rate Q_s at each test point shall be calculated from the flow meter data using the manufacturer's prescribed method.

$$K_v = \frac{Q_{\text{reference}}}{Q_s}$$

where:

Q_s is the air flow rate at standard conditions (101.325 kPa, 273.15 K (0 °C)), m³/s;

$Q_{\text{reference}}$ is the air flow rate of the calibration flow meter at standard conditions (101.325 kPa, 273.15 K (0 °C)), m³/s;

K_v is the calibration coefficient.

For UFM systems without a heat exchanger, K_v shall be plotted as a function of T_{act} .

The maximum variation in K_v shall not exceed 0.3 per cent of the arithmetic average K_v value of all the measurements taken at the different temperatures.

3.5. System verification procedure

3.5.1. General requirements

- 3.5.1.1. The total accuracy of the CVS sampling system and analytical system shall be determined by introducing a known mass of an emissions gas compound into the system whilst it is being operated under normal test conditions and subsequently analysing and calculating the emission gas compounds according to the equations of Annex B7. The CFO method described in paragraph 3.5.1.1.1. of this annex and the gravimetric method described in paragraph 3.5.1.1.2. of this annex are both known to give sufficient accuracy.

The maximum permissible deviation between the quantity of gas introduced and the quantity of gas measured is ± 2 per cent.

3.5.1.1.1. Critical flow orifice (CFO) method

The CFO method meters a constant flow of pure gas (CO, CO₂, or C₃H₈) using a critical flow orifice device.

A known mass of pure carbon monoxide, carbon dioxide or propane gas shall be introduced into the CVS system through the calibrated critical orifice. If the inlet pressure is high enough, the flow rate q which is restricted by means of the critical flow orifice, is independent of orifice outlet pressure (critical flow). The CVS system shall be operated as in a normal exhaust emissions test and enough time shall be allowed for subsequent analysis. The gas collected in the sample bag shall be analysed by the usual equipment (see paragraph 4.1. of this annex) and the results compared to the concentration of the known gas samples. If deviations exceed ± 2 per cent, the cause of the malfunction shall be determined and corrected.

3.5.1.1.2. Gravimetric method

The gravimetric method weighs a quantity of pure gas (CO, CO₂, or C₃H₈).

The weight of a small cylinder filled with either pure carbon monoxide, carbon dioxide or propane shall be determined with a precision of ± 0.01 g. The CVS system shall operate under normal exhaust emissions test conditions while the pure gas is injected into the system for a time sufficient for subsequent analysis. The quantity of pure gas involved shall be determined by means of differential weighing. The gas accumulated in the bag shall be analysed by means of the

equipment normally used for exhaust gas analysis as described in paragraph 4.1. of this annex. The results shall be subsequently compared to the concentration figures computed previously. If deviations exceed ± 2 per cent, the cause of the malfunction shall be determined and corrected.

4. Emissions measurement equipment
 - 4.1. Gaseous emissions measurement equipment
 - 4.1.1. System overview
 - 4.1.1.1. A continuously proportional sample of the diluted exhaust gases and the dilution air shall be collected for analysis.
 - 4.1.1.2. The mass of gaseous emissions shall be determined from the proportional sample concentrations and the total volume measured during the test. Sample concentrations shall be corrected to take into account the respective compound concentrations in dilution air.
 - 4.1.2. Sampling system requirements
 - 4.1.2.1. The sample of diluted exhaust gases shall be taken upstream from the suction device.

With the exception of paragraphs 4.1.3.1. (hydrocarbon sampling system), paragraph 4.2. (PM measurement equipment) and paragraph 4.3 of this annex. (PN measurement equipment) of this annex, the dilute exhaust gas sample may be taken downstream of the conditioning devices (if any).
 - 4.1.2.2. The bag sampling flow rate shall be set to provide sufficient volumes of dilution air and diluted exhaust in the CVS bags to allow concentration measurement and shall not exceed 0.3 per cent of the flow rate of the dilute exhaust gases, unless the diluted exhaust bag fill volume is added to the integrated CVS volume.
 - 4.1.2.3. A sample of the dilution air shall be taken near the dilution air inlet (after the filter if one is fitted).
 - 4.1.2.4. The dilution air sample shall not be contaminated by exhaust gases from the mixing area.
 - 4.1.2.5. The sampling rate for the dilution air shall be comparable to that used for the dilute exhaust gases.
 - 4.1.2.6. The materials used for the sampling operations shall be such as not to change the concentration of the emissions compounds.
 - 4.1.2.7. Filters may be used in order to extract the solid particles from the sample.
 - 4.1.2.8. Any valve used to direct the exhaust gases shall be of a quick-adjustment, quick-acting type.
 - 4.1.2.9. Quick-fastening, gas-tight connections may be used between three-way valves and the sample bags, the connections sealing themselves automatically on the bag side. Other systems may be used for conveying the samples to the analyser (e.g. three-way stop valves).
 - 4.1.2.10. Sample storage
 - 4.1.2.10.1. The gas samples shall be collected in sample bags of sufficient capacity so as not to impede the sample flow.
 - 4.1.2.10.2. The bag material shall be such as to affect neither the measurements themselves nor the chemical composition of the gas samples by more than ± 2 per cent after 30 minutes (e.g., laminated polyethylene/polyamide films, or fluorinated polyhydrocarbons).

- 4.1.3. Sampling systems
- 4.1.3.1. Hydrocarbon sampling system (heated flame ionisation detector, HFID)
- 4.1.3.1.1. The hydrocarbon sampling system shall consist of a heated sampling probe, line, filter and pump. The sample shall be taken upstream of the heat exchanger (if fitted). The sampling probe shall be installed at the same distance from the exhaust gas inlet as the particulate sampling probe and in such a way that neither interferes with samples taken by the other. It shall have a minimum internal diameter of 4 mm.
- 4.1.3.1.2. All heated parts shall be maintained at a temperature of $190\text{ °C} \pm 10\text{ °C}$ by the heating system.
- 4.1.3.1.3. The arithmetic average concentration of the measured hydrocarbons shall be determined by integration of the second-by-second data divided by the phase or test duration.
- 4.1.3.1.4. The heated sampling line shall be fitted with a heated filter F_H having a 99 per cent efficiency for particles $\geq 0.3\text{ }\mu\text{m}$ to extract any solid particles from the continuous flow of gas required for analysis.
- 4.1.3.1.5. The sampling system delay time (from the probe to the analyser inlet) shall be no more than 4 seconds.
- 4.1.3.1.6. The HFID shall be used with a constant mass flow (heat exchanger) system to ensure a representative sample, unless compensation for varying CVS volume flow is made.
- 4.1.4. Analysers
- 4.1.4.1. General requirements for gas analysis
- 4.1.4.1.1. The analysers shall have a measuring range compatible with the accuracy required to measure the concentrations of the exhaust gas sample compounds.
- 4.1.4.1.2. If not defined otherwise, measurement errors shall not exceed ± 2 per cent (intrinsic error of analyser) disregarding the reference value for the calibration gases.
- 4.1.4.1.3. The ambient air sample shall be measured on the same analyser with the same range.
- 4.1.4.1.4. No gas drying device shall be used before the analysers unless it is shown to have no effect on the content of the compound in the gas stream.
- 4.1.4.2. Carbon monoxide (CO) and carbon dioxide (CO₂) analysis
- The analysers shall be of the non-dispersive infrared (NDIR) absorption type.
- 4.1.4.3. Hydrocarbons (HC) analysis for all fuels other than diesel fuel
- The analyser shall be of the flame ionization (FID) type calibrated with propane gas expressed in equivalent carbon atoms (C₁).
- 4.1.4.4. Hydrocarbons (HC) analysis for diesel fuel and optionally for other fuels
- The analyser shall be of the heated flame ionization type with detector, valves, pipework, etc., heated to $190\text{ °C} \pm 10\text{ °C}$. It shall be calibrated with propane gas expressed equivalent to carbon atoms (C₁).
- 4.1.4.5. Methane (CH₄) analysis
- The analyser shall be either a gas chromatograph combined with a flame ionization detector (FID), or a flame ionization detector (FID) combined with a non-methane cutter (NMC-FID), calibrated with methane or propane gas expressed equivalent to carbon atoms (C₁).

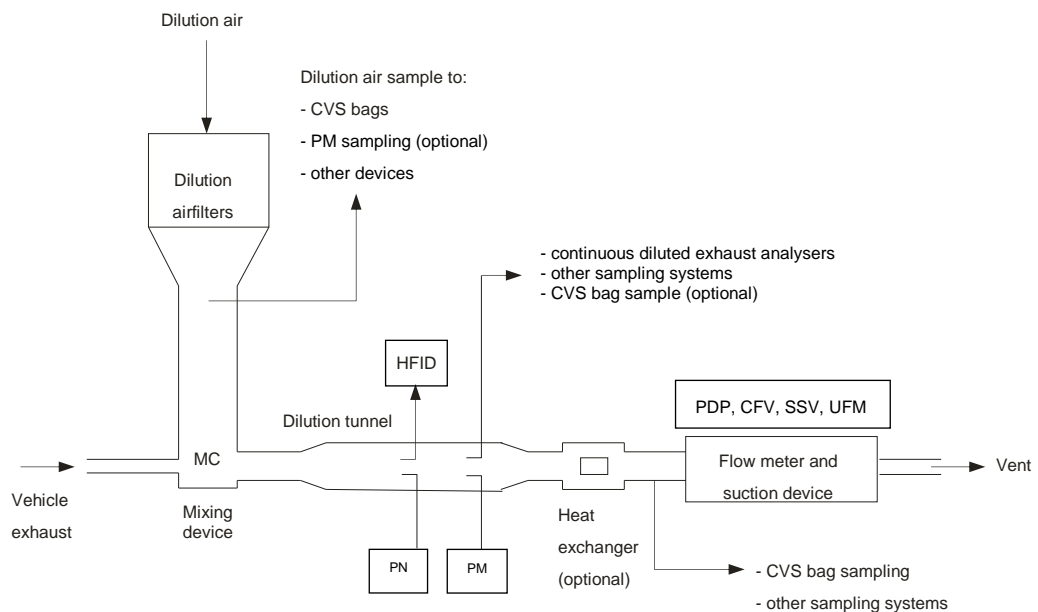
- 4.1.4.6. Nitrogen oxides (NO_x) analysis
The analysers shall be of chemiluminescent (CLA) or non-dispersive ultra-violet resonance absorption (NDUV) types.
- 4.1.4.11. Hydrogen (H₂) analysis (if applicable)
The analyser shall be of the sector field mass spectrometry type, calibrated with hydrogen.
- 4.1.4.12. Water (H₂O) analysis (if applicable)
The analyser shall be of the non-dispersive infrared analyzer (NDIR) absorption type. The NDIR shall be calibrated either with water vapour or with propylene (C₃H₆). If the NDIR is calibrated with water vapour, it shall be ensured that no water condensation can occur in tubes and connections during the calibration process. If the NDIR is calibrated with propylene, the manufacturer of the analyzer shall provide the information for converting the concentration of propylene to its corresponding concentration of water vapour. The values for conversion shall be periodically checked by the manufacturer of the analyzer, and at least once per year.

4.1.5. Recommended system descriptions

- 4.1.5.1. Figure A5/9 is a schematic drawing of the gaseous emissions sampling system.

Figure A5/9

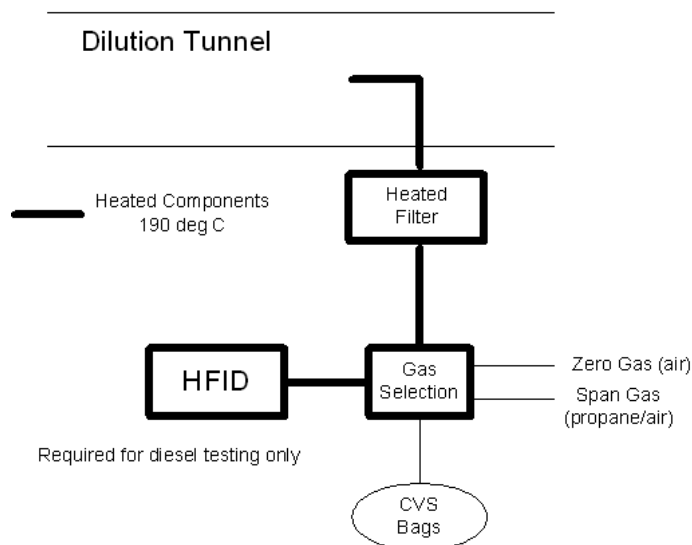
Full flow exhaust dilution system schematic



- 4.1.5.2. Examples of system components are as listed below.
- 4.1.5.2.1. Two sampling probes for continuous sampling of the dilution air and of the diluted exhaust gas/air mixture.
- 4.1.5.2.2. A filter to extract solid particles from the flows of gas collected for analysis.
- 4.1.5.2.3. Pumps and flow controller to ensure constant uniform flow of diluted exhaust gas and dilution air samples taken during the course of the test from sampling probes and flow of the gas samples shall be such that, at the end of each test, the quantity of the samples is sufficient for analysis.
- 4.1.5.2.4. Quick-acting valves to divert a constant flow of gas samples into the sample bags or to the outside vent.

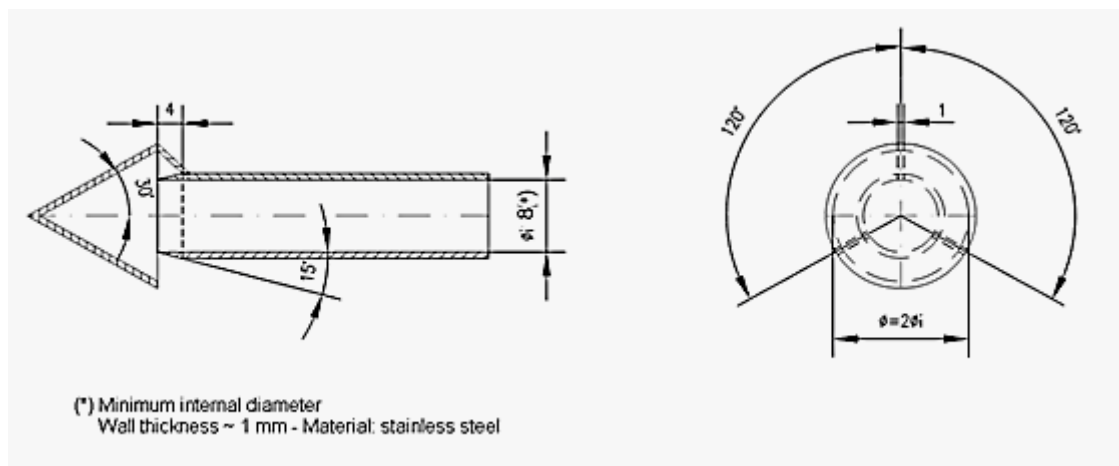
- 4.1.5.2.5. Gas-tight, quick-lock coupling elements between the quick-acting valves and the sample bags. The coupling shall close automatically on the sampling bag side. As an alternative, other methods of transporting the samples to the analyser may be used (three-way stopcocks, for instance).
- 4.1.5.2.6. Bags for collecting samples of the diluted exhaust gas and of the dilution air during the test.
- 4.1.5.2.7. A sampling critical flow venturi to take proportional samples of the diluted exhaust gas (CFV-CVS only).
- 4.1.5.3. Additional components required for hydrocarbon sampling using a heated flame ionization detector (HFID) as shown in Figure A5/10.
- 4.1.5.3.1. Heated sample probe in the dilution tunnel located in the same vertical plane as the particulate and, if applicable, particle sample probes.
- 4.1.5.3.2. Heated filter located after the sampling point and before the HFID.
- 4.1.5.3.3. Heated selection valves between the zero/calibration gas supplies and the HFID.
- 4.1.5.3.4. Means of integrating and recording instantaneous hydrocarbon concentrations.
- 4.1.5.3.5. Heated sampling lines and heated components from the heated probe to the HFID.

Figure A5/10

Components required for hydrocarbon sampling using an HFID

- 4.2. PM measurement equipment
- 4.2.1. Specification
- 4.2.1.1. System overview
- 4.2.1.1.1. The particulate sampling unit shall consist of a sampling probe (PSP), located in the dilution tunnel, a particle transfer tube (PTT), a filter holder(s) (FH), pump(s), flow rate regulators and measuring units. See Figures A5/11, A5/12 and A5/13.
- 4.2.1.1.2. A particle size pre-classifier (PCF), (e.g. cyclone or impactor) may be used. In such case, it is recommended that it be employed upstream of the filter holder.

Figure A5/11
Alternative particulate sampling probe configuration



- 4.2.1.2. General requirements
- 4.2.1.2.1. The sampling probe for the test gas flow for particulate shall be arranged within the dilution tunnel so that a representative sample gas flow can be taken from the homogeneous air/exhaust mixture and shall be upstream of a heat exchanger (if any).
- 4.2.1.2.2. The particulate sample flow rate shall be proportional to the total mass flow of diluted exhaust gas in the dilution tunnel to within a tolerance of ± 5 per cent of the particulate sample flow rate. The verification of the proportionality of the particulate sampling shall be made during the commissioning of the system and as required by the responsible authority.
- 4.2.1.2.3. The sampled dilute exhaust gas shall be maintained at a temperature above $20\text{ }^{\circ}\text{C}$ and below $52\text{ }^{\circ}\text{C}$ within 20 cm upstream or downstream of the particulate sampling filter face. Heating or insulation of components of the particulate sampling system to achieve this is permitted.
- In the event that the $52\text{ }^{\circ}\text{C}$ limit is exceeded during a test where periodic regeneration event does not occur, the CVS flow rate shall be increased or double dilution shall be applied (assuming that the CVS flow rate is already sufficient so as not to cause condensation within the CVS, sample bags or analytical system).
- 4.2.1.2.4. The particulate sample shall be collected on a single filter mounted within a holder in the sampled dilute exhaust gas flow.
- 4.2.1.2.5. All parts of the dilution system and the sampling system from the exhaust pipe up to the filter holder that are in contact with raw and diluted exhaust gas shall be designed to minimise deposition or alteration of the particulate. All parts shall be made of electrically conductive materials that do not react with exhaust gas components, and shall be electrically grounded to prevent electrostatic effects.
- 4.2.1.2.6. If it is not possible to compensate for variations in the flow rate, provision shall be made for a heat exchanger and a temperature control device as specified in paragraphs 3.3.5.1. or 3.3.6.4.2. of this annex, so as to ensure that the flow rate in the system is constant and the sampling rate accordingly proportional.
- 4.2.1.2.7. Temperatures required for the measurement of PM shall be measured with an accuracy of $\pm 1\text{ }^{\circ}\text{C}$ and a response time ($t_{90} - t_{10}$) of 15 seconds or less.
- 4.2.1.2.8. The sample flow from the dilution tunnel shall be measured with an accuracy of ± 2.5 per cent of reading or ± 1.5 per cent full scale, whichever is the least.
- The accuracy specified above of the sample flow from the CVS tunnel is also applicable where double dilution is used. Consequently, the measurement and

control of the secondary dilution air flow and diluted exhaust flow rates through the filter shall be of a higher accuracy.

4.2.1.2.9. All data channels required for the measurement of PM shall be logged at a frequency of 1 Hz or faster. Typically, these would include:

- (a) Diluted exhaust temperature at the particulate sampling filter;
- (b) Sampling flow rate;
- (c) Secondary dilution air flow rate (if secondary dilution is used);
- (d) Secondary dilution air temperature (if secondary dilution is used).

4.2.1.2.10. For double dilution systems, the accuracy of the diluted exhaust transferred from the dilution tunnel V_{ep} defined in paragraph 3.3.2. of Annex B7 in the equation is not measured directly but determined by differential flow measurement.

The accuracy of the flow meters used for the measurement and control of the double diluted exhaust passing through the particulate sampling filters and for the measurement/control of secondary dilution air shall be sufficient so that the differential volume V_{ep} shall meet the accuracy and proportional sampling requirements specified for single dilution.

The requirement that no condensation of the exhaust gas occur in the CVS dilution tunnel, diluted exhaust flow rate measurement system, CVS bag collection or analysis systems shall also apply in the case that double dilution systems are used.

4.2.1.2.11. Each flow meter used in a particulate sampling and double dilution system shall be subjected to a linearity verification as required by the instrument manufacturer.

Figure A5/12

Particulate sampling system

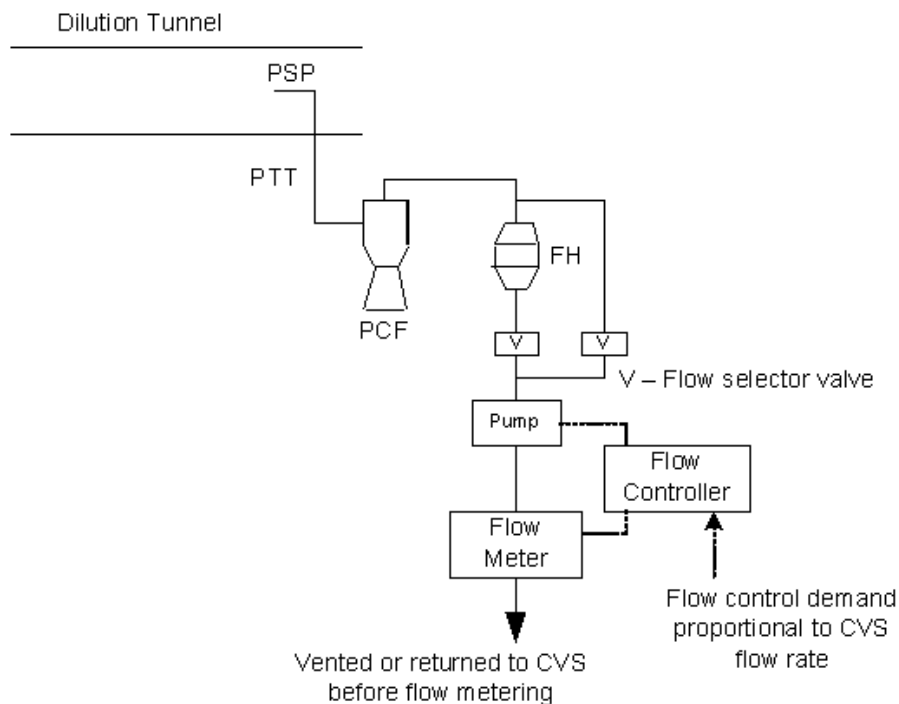
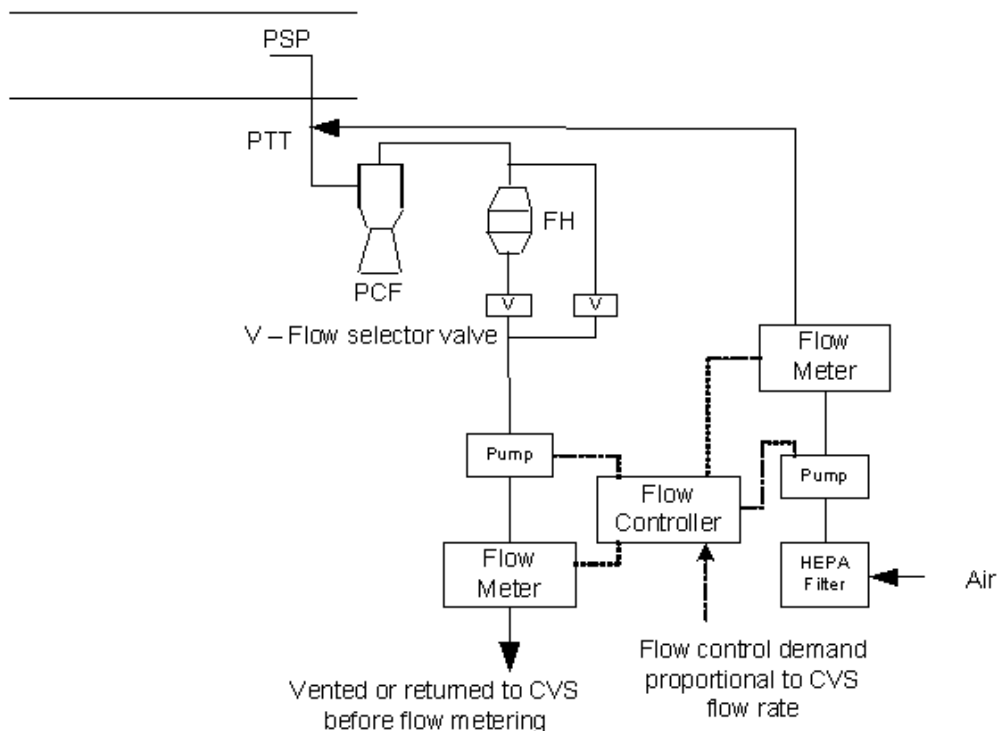


Figure A5/13
Double dilution particulate sampling system



4.2.1.3. Specific requirements

4.2.1.3.1. Sample probe

4.2.1.3.1.1. The sample probe shall deliver the particle size classification performance specified in paragraph 4.2.1.3.1.4. of this annex. It is recommended that this performance be achieved by the use of a sharp-edged, open-ended probe facing directly into the direction of flow plus a pre-classifier (cyclone impactor, etc.). An appropriate sample probe, such as that indicated in Figure A5/11, may alternatively be used provided it achieves the pre-classification performance specified in paragraph 4.2.1.3.1.4. of this annex.

4.2.1.3.1.2. The sample probe shall be installed at least 10 tunnel diameters downstream of the exhaust gas inlet to the tunnel and have an internal diameter of at least 8 mm.

If more than one simultaneous sample is drawn from a single sample probe, the flow drawn from that probe shall be split into identical sub-flows to avoid sampling artefacts.

If multiple probes are used, each probe shall be sharp-edged, open-ended and facing directly into the direction of flow. Probes shall be equally spaced around the central longitudinal axis of the dilution tunnel, with a spacing between probes of at least 5 cm.

4.2.1.3.1.3. The distance from the sampling tip to the filter mount shall be at least five probe diameters, but shall not exceed 2,000 mm.

4.2.1.3.1.4. The pre-classifier (e.g. cyclone, impactor, etc.) shall be located upstream of the filter holder assembly. The pre-classifier 50 per cent cut point particle diameter shall be between 2.5 μm and 10 μm at the volumetric flow rate selected for sampling PM. The pre-classifier shall allow at least 99 per cent of the mass concentration of 1 μm particles entering the pre-classifier to pass through the exit of the pre-classifier at the volumetric flow rate selected for sampling PM.

- 4.2.1.3.2. Particle transfer tube (PTT)
Any bends in the PTT shall be smooth and have the largest possible radii.
- 4.2.1.3.3. Secondary dilution
- 4.2.1.3.3.1. As an option, the sample extracted from the CVS for the purpose of PM measurement may be diluted at a second stage, subject to the following requirements:
- 4.2.1.3.3.1.1. Secondary dilution air shall be filtered through a medium capable of reducing particles in the most penetrating particle size of the filter material by ≥ 99.95 per cent, or through a HEPA filter of at least Class H13 of EN 1822:2009. The dilution air may optionally be charcoal-scrubbed before being passed to the HEPA filter. It is recommended that an additional coarse particle filter be situated before the HEPA filter and after the charcoal scrubber, if used.
- 4.2.1.3.3.1.2. The secondary dilution air should be injected into the PTT as close to the outlet of the diluted exhaust from the dilution tunnel as possible.
- 4.2.1.3.3.1.3. The residence time from the point of secondary diluted air injection to the filter face shall be at least 0.25 seconds, but no longer than 5 seconds.
- 4.2.1.3.3.1.4. If the double diluted sample is returned to the CVS, the location of the sample return shall be selected so that it does not interfere with the extraction of other samples from the CVS.
- 4.2.1.3.4. Sample pump and flow meter
- 4.2.1.3.4.1. The sample gas flow measurement unit shall consist of pumps, gas flow regulators and flow measuring units.
- 4.2.1.3.4.2. The temperature of the gas flow in the flow meter may not fluctuate by more than ± 3 °C except:
- (a) When the sampling flow meter has real time monitoring and flow control operating at a frequency of 1 Hz or faster;
 - (b) During regeneration tests on vehicles equipped with periodically regenerating after-treatment devices.
- Should the volume of flow change unacceptably as a result of excessive filter loading, the test shall be invalidated. When it is repeated, the flow rate shall be decreased.
- 4.2.1.3.5. Filter and filter holder
- 4.2.1.3.5.1. A valve shall be located downstream of the filter in the direction of flow. The valve shall open and close within 1 second of the start and end of test.
- 4.2.1.3.5.2. For a given test, the gas filter face velocity shall be set to an initial value within the range 20 cm/s to 105 cm/s and shall be set at the start of the test so that 105 cm/s will not be exceeded when the dilution system is being operated with sampling flow proportional to CVS flow rate.
- 4.2.1.3.5.3. Fluorocarbon coated glass fibre filters or fluorocarbon membrane filters shall be used.
- All filter types shall have a 0.3 μm DOP (di-octylphthalate) or PAO (poly-alpha-olefin) CS 68649-12-7 or CS 68037-01-4 collection efficiency of at least 99 per cent at a gas filter face velocity of 5.33 cm/s measured according to one of the following standards:
- (a) U.S.A. Department of Defense Test Method Standard, MIL-STD-282 method 102.8: DOP-Smoke Penetration of Aerosol-Filter Element;
 - (b) U.S.A. Department of Defense Test Method Standard, MIL-STD-282 method 502.1.1: DOP-Smoke Penetration of Gas-Mask Canisters;

- (c) Institute of Environmental Sciences and Technology, IEST-RP-CC021: Testing HEPA and ULPA Filter Media.
- 4.2.1.3.5.4. The filter holder assembly shall be of a design that provides an even flow distribution across the filter stain area. The filter shall be round and have a stain area of at least 1,075 mm².
- 4.2.2. Weighing chamber (or room) and analytical balance specifications
- 4.2.2.1. Weighing chamber (or room) conditions
- (a) The temperature of the weighing chamber (or room) in which the particulate sampling filters are conditioned and weighed shall be maintained to within 22 °C ±2 °C (22 °C ±1 °C if possible) during all filter conditioning and weighing;
- (b) Humidity shall be maintained at a dew point of less than 10.5 °C and a relative humidity of 45 per cent ±8 per cent;
- (c) Limited deviations from weighing chamber (or room) temperature and humidity specifications shall be permitted provided their total duration does not exceed 30 minutes in any one filter conditioning period;
- (d) The levels of ambient contaminants in the weighing chamber (or room) environment that would settle on the particulate sampling filters during their stabilisation shall be minimised;
- (e) During the weighing operation no deviations from the specified conditions are permitted.
- 4.2.2.2. Linear response of an analytical balance

The analytical balance used to determine the filter weight shall meet the linearity verification criteria of Table A5/1 applying a linear regression. This implies a precision of at least ±2 µg and a resolution of at least 1 µg (1 digit = 1 µg). At least 4 equally-spaced reference weights shall be tested. The zero value shall be within ±1 µg.

Table A5/1
Analytical balance verification criteria

<i>Measurement system</i>	<i>Intercept a0</i>	<i>Slope a1</i>	<i>Standard error of estimate (SEE)</i>	<i>Coefficient of determination r²</i>
Particulate balance	≤ 1 µg	0.99 – 1.01	≤ 1 per cent max	≥ 0.998

- 4.2.2.3. Elimination of static electricity effects
- The effects of static electricity shall be nullified. This may be achieved by grounding the balance through placement upon an antistatic mat and neutralization of the particulate sampling filters prior to weighing using a polonium neutraliser or a device of similar effect. Alternatively, nullification of static effects may be achieved through equalization of the static charge.
- 4.2.2.4. Buoyancy correction
- The sample and reference filter weights shall be corrected for their buoyancy in air. The buoyancy correction is a function of sampling filter density, air density and the density of the balance calibration weight, and does not account for the buoyancy of the particulate matter itself.
- If the density of the filter material is not known, the following densities shall be used:
- (a) PTFE coated glass fibre filter: 2,300 kg/m³;
- (b) PTFE membrane filter: 2,144 kg/m³;

- (c) PTFE membrane filter with polymethylpentene support ring:
920 kg/m³.

For stainless steel calibration weights, a density of 8,000 kg/m³ shall be used. If the material of the calibration weight is different, its density shall be known and be used. International Recommendation OIML R 111-1 Edition 2004(E) (or equivalent) from International Organization of Legal Metrology on calibration weights should be followed.

The following equation shall be used:

$$Pe_f = Pe_{\text{uncorr}} \times \left(\frac{1 - \frac{\rho_a}{\rho_w}}{1 - \frac{\rho_a}{\rho_f}} \right)$$

where:

Pe_f is the corrected particulate sample mass, mg;

Pe_{uncorr} is the uncorrected particulate sample mass, mg;

ρ_a is the density of the air, kg/m³;

ρ_w is the density of balance calibration weight, kg/m³;

ρ_f is the density of the particulate sampling filter, kg/m³.

The density of the air ρ_a shall be calculated using the following equation:

$$\rho_a = \frac{p_b \times M_{\text{mix}}}{R \times T_a}$$

p_b is the total atmospheric pressure, kPa;

T_a is the air temperature in the balance environment, Kelvin (K);

M_{mix} is the molar mass of air in a balanced environment, 28.836 g mol⁻¹;

R is the molar gas constant, 8.3144 J mol⁻¹ K⁻¹.

- 4.3. PN measurement equipment (if PN measurement is required)
- 4.3.1. Specification
- 4.3.1.1. System overview
- 4.3.1.1.1. The particle sampling system shall consist of a probe or sampling point extracting a sample from a homogeneously mixed flow in a dilution system, a volatile particle remover (VPR) upstream of a particle number counter (PNC) and suitable transfer tubing. See Figure A5/14.
- 4.3.1.1.2. It is recommended that a particle size pre-classifier (PCF) (e.g. cyclone, impactor, etc.) be located prior to the inlet of the VPR. The PCF 50 per cent cut point particle diameter shall be between 2.5 µm and 10 µm at the volumetric flow rate selected for particle sampling. The PCF shall allow at least 99 per cent of the mass concentration of 1 µm particles entering the PCF to pass through the exit of the PCF at the volumetric flow rate selected for particle sampling.
- A sample probe acting as an appropriate size-classification device, such as that shown in Figure A5/11, is an acceptable alternative to the use of a PCF.
- 4.3.1.2. General requirements
- 4.3.1.2.1. The particle sampling point shall be located within a dilution system. In the case that a double dilution system is used, the particle sampling point shall be located within the primary dilution system.
- 4.3.1.2.1.1. The sampling probe tip or PSP, and the PTT, together comprise the particle transfer system (PTS). The PTS conducts the sample from the dilution tunnel to the entrance of the VPR. The PTS shall meet the following conditions:

- (a) The sampling probe shall be installed at least 10 tunnel diameters downstream of the exhaust gas inlet, facing upstream into the tunnel gas flow with its axis at the tip parallel to that of the dilution tunnel;
 - (b) The sampling probe shall be upstream of any conditioning device (e.g. heat exchanger);
 - (c) The sampling probe shall be positioned within the dilution tunnel so that the sample is taken from a homogeneous diluent/exhaust mixture.
- 4.3.1.2.1.2. Sample gas drawn through the PTS shall meet the following conditions:
- (a) In the case that a full flow exhaust dilution system, is used it shall have a flow Reynolds number Re lower than 1,700;
 - (b) In the case that a double dilution system is used, it shall have a flow Reynolds number Re lower than 1,700 in the PTT i.e. downstream of the sampling probe or point;
 - (c) Shall have a residence time ≤ 3 seconds.
- 4.3.1.2.1.3. Any other sampling configuration for the PTS for which equivalent particle penetration at 30 nm can be demonstrated shall be considered acceptable.
- 4.3.1.2.1.4. The outlet tube (OT), conducting the diluted sample from the VPR to the inlet of the PNC, shall have the following properties:
- (a) An internal diameter ≥ 4 mm;
 - (b) A sample gas flow residence time of ≤ 0.8 seconds.
- 4.3.1.2.1.5. Any other sampling configuration for the OT for which equivalent particle penetration at 30 nm can be demonstrated shall be considered acceptable.
- 4.3.1.2.2. The VPR shall include devices for sample dilution and for volatile particle removal.
- 4.3.1.2.3. All parts of the dilution system and the sampling system from the exhaust pipe up to the PNC, which are in contact with raw and diluted exhaust gas, shall be designed to minimize deposition of the particles. All parts shall be made of electrically conductive materials that do not react with exhaust gas components, and shall be electrically grounded to prevent electrostatic effects.
- 4.3.1.2.4. The particle sampling system shall incorporate good aerosol sampling practice that includes the avoidance of sharp bends and abrupt changes in cross-section, the use of smooth internal surfaces and the minimization of the length of the sampling line. Gradual changes in the cross-section are permitted.
- 4.3.1.3. Specific requirements
- 4.3.1.3.1. The particle sample shall not pass through a pump before passing through the PNC.
- 4.3.1.3.2. A sample pre-classifier is recommended.
- 4.3.1.3.3. The sample preconditioning unit shall:
- (a) Be capable of diluting the sample in one or more stages to achieve a particle number concentration below the upper threshold of the single particle count mode of the PNC and a gas temperature below 35 °C at the inlet to the PNC;
 - (b) Include an initial heated dilution stage that outputs a sample at a temperature of ≥ 150 °C and ≤ 350 °C ± 10 °C, and dilutes by a factor of at least 10;
 - (c) Control heated stages to constant nominal operating temperatures, within the range ≥ 150 °C and ≤ 400 °C ± 10 °C;

- (d) Provide an indication of whether or not heated stages are at their correct operating temperatures;
- (e) Be designed to achieve a solid particle penetration efficiency of at least 70 per cent for particles of 100 nm electrical mobility diameter;
- (f) Achieve a particle concentration reduction factor $f_r(d_i)$ for particles of 30 nm and 50 nm electrical mobility diameters that is no more than 30 per cent and 20 per cent respectively higher, and no more than 5 per cent lower than that for particles of 100 nm electrical mobility diameter for the VPR as a whole;

The particle concentration reduction factor at each particle size $f_r(d_i)$ shall be calculated using the following equation:

$$f_r(d_i) = \frac{N_{in}(d_i)}{N_{out}(d_i)}$$

where:

$N_{in}(d_i)$ is the upstream particle number concentration for particles of diameter d_i ;

$N_{out}(d_i)$ is the downstream particle number concentration for particles of diameter d_i ;

d_i is the particle electrical mobility diameter (30, 50 or 100 nm).

$N_{in}(d_i)$ and $N_{out}(d_i)$ shall be corrected to the same conditions.

The arithmetic average particle concentration reduction factor at a given dilution setting \bar{f}_r shall be calculated using the following equation:

$$\bar{f}_r = \frac{f_r(30 \text{ nm}) + f_r(50 \text{ nm}) + f_r(100 \text{ nm})}{3}$$

It is recommended that the VPR is calibrated and validated as a complete unit;

- (g) Be designed according to good engineering practice to ensure particle concentration reduction factors are stable across a test;
- (h) Also achieve more than 99.0 per cent vaporization of 30 nm tetracontane ($\text{CH}_3(\text{CH}_2)_{38}\text{CH}_3$) particles, with an inlet concentration of $\geq 10,000$ per cm^3 , by means of heating and reduction of partial pressures of the tetracontane.

4.3.1.3.4. The PNC shall:

- (a) Operate under full flow operating conditions;
- (b) Have a counting accuracy of ± 10 per cent across the range 1 per cm^3 to the upper threshold of the single particle count mode of the PNC against a suitable traceable standard. At concentrations below 100 per cm^3 , measurements averaged over extended sampling periods may be required to demonstrate the accuracy of the PNC with a high degree of statistical confidence;
- (c) Have a resolution of at least 0.1 particles per cm^3 at concentrations below 100 per cm^3 ;
- (d) Have a linear response to particle number concentrations over the full measurement range in single particle count mode;
- (e) Have a data reporting frequency equal to or greater than a frequency of 0.5 Hz;

- (f) Have a t_{90} response time over the measured concentration range of less than 5 seconds;
- (g) Incorporate a coincidence correction function up to a maximum 10 per cent correction, and may make use of an internal calibration factor as determined in paragraph 5.7.1.3. of this annex but shall not make use of any other algorithm to correct for or define the counting efficiency;
- (h) Have counting efficiencies at the different particle sizes as specified in Table A5/2.

Table A5/2

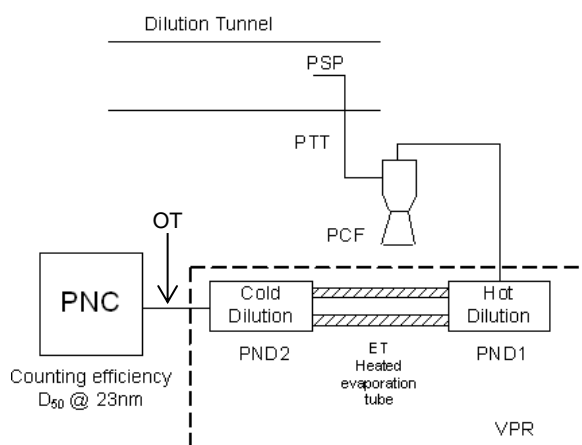
PNC counting efficiency

<i>Particle size electrical mobility diameter (nm)</i>	<i>PNC counting efficiency (per cent)</i>
23 ±1	50 ±12
41 ±1	> 90

- 4.3.1.3.5. If the PNC makes use of a working liquid, it shall be replaced at the frequency specified by the instrument manufacturer.
- 4.3.1.3.6. Where not held at a known constant level at the point at which PNC flow rate is controlled, the pressure and/or temperature at the PNC inlet shall be measured for the purposes of correcting particle number concentration measurements to standard conditions.
- 4.3.1.3.7. The sum of the residence time of the PTS, VPR and OT plus the t_{90} response time of the PNC shall be no greater than 20 seconds.
- 4.3.1.4. Recommended system description

The following paragraph contains the recommended practice for measurement of PN. However, systems meeting the performance specifications in paragraphs 4.3.1.2. and 4.3.1.3. of this annex are acceptable.

Figure A5/14

A recommended particle sampling system

- 4.3.1.4.1. Sampling system description
 - 4.3.1.4.1.1. The particle sampling system shall consist of a sampling probe tip or particle sampling point in the dilution system, a PTT, a PCF, and a VPR, upstream of the PNC unit.
 - 4.3.1.4.1.2. The VPR shall include devices for sample dilution (particle number diluters: PND₁ and PND₂) and particle evaporation (evaporation tube, ET).

4.3.1.4.1.3. The sampling probe or sampling point for the test gas flow shall be arranged within the dilution tunnel so that a representative sample gas flow is taken from a homogeneous diluent/exhaust mixture.

5. Calibration intervals and procedures

5.1. Calibration intervals

All instruments in Table A5/3 shall be calibrated at/after major maintenance intervals.

Table A5/3

Instrument calibration intervals

<i>Instrument checks</i>	<i>Interval</i>	<i>Criterion</i>
Gas analyser linearization (calibration)	Every 6 months	±2 per cent of reading
Mid-span	Every 6 months	±2 per cent
CO NDIR: CO ₂ /H ₂ O interference	Monthly	-1 to 3 ppm
NO _x converter check	Monthly	> 95 per cent
CH ₄ cutter check	Yearly	98 per cent of ethane
FID CH ₄ response	Yearly	See paragraph 5.4.3. of this annex.
FID air/fuel flow	At major maintenance	According to the instrument manufacturer.
NO/NO ₂ NDUV: H ₂ O, HC interference	At major maintenance	According to the instrument manufacturer.
Laser infrared spectrometers (modulated high resolution narrow band infrared analysers): interference check	Yearly	According to the instrument manufacturer.
QCL	Yearly	According to the instrument manufacturer.
GC methods	See paragraph 7.2. of this annex.	See paragraph 7.2. of this annex.
LC methods	Yearly	According to the instrument manufacturer.
Photoacoustics	Yearly	According to the instrument manufacturer.
FTIR: linearity verification	Within 370 days before testing	See paragraph 7.1. of this annex.
Microgram balance linearity	Yearly	See paragraph 4.2.2.2. of this annex.
PNC (particle number counter) (if applicable)	See paragraph 5.7.1.1. of this annex	See paragraph 5.7.1.3. of this annex.
VPR (volatile particle remover)	See paragraph 5.7.2.1. of this annex.	See paragraph 5.7.2. of this annex.

Table A5/4

Constant volume sampler (CVS) calibration intervals

<i>CVS</i>	<i>Interval</i>	<i>Criterion</i>
CVS flow	After overhaul	±2 per cent
Temperature sensor	Yearly	±1 °C
Pressure sensor	Yearly	±0.4 kPa
Injection check	Weekly	±2 per cent

Table A5/5

Environmental data calibration intervals

<i>Climate</i>	<i>Interval</i>	<i>Criterion</i>
Temperature	Yearly	±1 °C
Moisture dew	Yearly	±5 per cent RH
Ambient pressure	Yearly	±0.4 kPa
Cooling fan	After overhaul	According to paragraph 1.1.1. of this annex.

- 5.2. Analyser calibration procedures
- 5.2.1. Each analyser shall be calibrated as specified by the instrument manufacturer or at least as often as specified in Table A5/3.
- 5.2.2. Each normally used operating range shall be linearized by the following procedure:
- 5.2.2.1. The analyser linearization curve shall be established by at least five calibration points spaced as uniformly as possible. The nominal concentration of the calibration gas of the highest concentration shall be not less than 80 per cent of the full scale.
- 5.2.2.2. The calibration gas concentration required may be obtained by means of a gas divider, diluting with purified N₂ or with purified synthetic air.
- 5.2.2.3. The linearization curve shall be calculated by the least squares method. If the resulting polynomial degree is greater than 3, the number of calibration points shall be at least equal to this polynomial degree plus 2.
- 5.2.2.4. The linearization curve shall not differ by more than ±2 per cent from the nominal value of each calibration gas.
- 5.2.2.5. From the trace of the linearization curve and the linearization points it is possible to verify that the calibration has been carried out correctly. The different characteristic parameters of the analyser shall be indicated, particularly:
- Analyser and gas component;
 - Range;
 - Date of linearisation.
- 5.2.2.6. If the responsible authority is satisfied that alternative technologies (e.g. computer, electronically controlled range switch, etc.) give equivalent accuracy, these alternatives may be used.
- 5.3. Analyser zero and calibration verification procedure
- 5.3.1. Each normally used operating range shall be checked prior to each analysis in accordance with paragraphs 5.3.1.1. and 5.3.1.2. of this annex

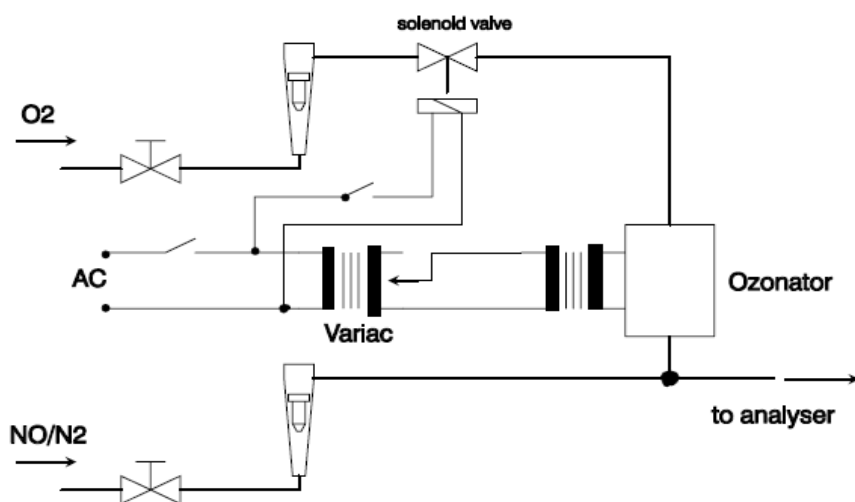
- 5.3.1.1. The calibration shall be checked by use of a zero gas and by use of a calibration gas according to paragraph 2.14.2.3. of Annex B6.
- 5.3.1.2. After testing, zero gas and the same calibration gas shall be used for re-checking according to paragraph 2.14.2.4. of Annex B6.
- 5.4. FID hydrocarbon response check procedure
- 5.4.1. Detector response optimization
- The FID shall be adjusted as specified by the instrument manufacturer. Propane in air shall be used on the most common operating range.
- 5.4.2. Calibration of the HC analyser
- 5.4.2.1. The analyser shall be calibrated using propane in air and purified synthetic air.
- 5.4.2.2. A calibration curve as described in paragraph 5.2.2. of this annex shall be established.
- 5.4.3. Response factors of different hydrocarbons and recommended limits
- 5.4.3.1. The response factor, R_f , for a particular hydrocarbon compound is the ratio of the FID C_1 reading to the gas cylinder concentration, expressed as ppm C_1 .
- The concentration of the test gas shall be at a level to give a response of approximately 80 per cent of full-scale deflection for the operating range. The concentration shall be known to an accuracy of ± 2 per cent in reference to a gravimetric standard expressed in volume. In addition, the gas cylinder shall be preconditioned for 24 hours at a temperature between 20 and 30 °C.
- 5.4.3.2. The methane factor $R_{f_{CH_4}}$ shall be measured and determined when introducing an analyser into service, and yearly thereafter or after major maintenance intervals, whichever comes first.
- The propylene response factor $R_{f_{C_3H_6}}$ and the toluene response factor $R_{f_{C_7H_8}}$ shall be measured when introducing an analyser into service. It is recommended that they be measured at or after major maintenance which might possibly affect the response factors.
- The test gases to be used and the recommended response factors are:
- Methane and purified air: $0.95 < R_{f_{CH_4}} < 1.15$
or $1.00 < R_f < 1.05$ for NG/biomethane fuelled vehicles
- Propylene and purified air: $0.85 < R_{f_{C_3H_6}} < 1.10$
- Toluene and purified air: $0.85 < R_{f_{C_7H_8}} < 1.10$
- The factors are relative to an R_f of 1.00 for propane and purified air.
- 5.5. NO_x converter efficiency test procedure
- 5.5.1. Using the test set up as shown in Figure A5/15 and the procedure described below, the efficiency of converters for the conversion of NO_2 into NO shall be tested by means of an ozonator as follows:
- 5.5.1.1. The analyser shall be calibrated in the most common operating range following the manufacturer's specifications using zero and calibration gas (the NO content of which shall amount to approximately 80 per cent of the operating range and the NO_2 concentration of the gas mixture shall be less than 5 per cent of the NO concentration). The NO_x analyser shall be in the NO mode so that the calibration gas does not pass through the converter. The indicated concentration shall be recorded.
- 5.5.1.2. Via a T-fitting, oxygen or synthetic air shall be added continuously to the calibration gas flow until the concentration indicated is approximately 10 per cent less than the indicated calibration concentration given in

paragraph 5.5.1.1. of this annex. The indicated concentration (c) shall be recorded. The ozonator shall be kept deactivated throughout this process.

- 5.5.1.3. The ozonator shall now be activated to generate enough ozone to bring the NO concentration down to 20 per cent (minimum 10 per cent) of the calibration concentration given in paragraph 5.5.1.1. of this annex. The indicated concentration (d) shall be recorded.
- 5.5.1.4. The NO_x analyser shall be subsequently switched to the NO_x mode, whereby the gas mixture (consisting of NO, NO₂, O₂ and N₂) now passes through the converter. The indicated concentration (a) shall be recorded.
- 5.5.1.5. The ozonator shall now be deactivated. The mixture of gases described in paragraph 5.5.1.2. of this annex shall pass through the converter into the detector. The indicated concentration (b) shall be recorded.

Figure A5/15

NO_x converter efficiency test configuration



- 5.5.1.6. With the ozonator deactivated, the flow of oxygen or synthetic air shall be shut off. The NO₂ reading of the analyser shall then be no more than 5 per cent above the figure given in paragraph 5.5.1.1. of this annex.
- 5.5.1.7. The per cent efficiency of the NO_x converter shall be calculated using the concentrations a, b, c and d determined in paragraphs 5.5.1.2. to 5.5.1.5. inclusive of this annex using the following equation:

$$\text{Efficiency} = \left(1 + \frac{a - b}{c - d}\right) \times 100$$

The efficiency of the converter shall not be less than 95 per cent. The efficiency of the converter shall be tested in the frequency defined in Table A5/3.

5.6. Calibration of the microgram balance

The calibration of the microgram balance used for particulate sampling filter weighing shall be traceable to a national or international standard. The balance shall comply with the linearity requirements given in paragraph 4.2.2.2. of this annex. The linearity verification shall be performed at least every 12 months or whenever a system repair or change is made that could influence the calibration.

5.7. Calibration and validation of the particle sampling system (if PN measurement is required)

Examples of calibration/validation methods are available at:
<http://www.unece.org/trans/main/wp29/wp29wgs/wp29grpe/pmpFCP.html>

5.7.1. Calibration of the PNC

- 5.7.1.1. The responsible authority shall ensure the existence of a calibration certificate for the PNC demonstrating compliance with a traceable standard within a 13-month period prior to the emissions test. Between calibrations either the counting efficiency of the PNC shall be monitored for deterioration or the PNC wick shall be routinely changed every 6 months. See Figures A5/16 and A5/17. PNC counting efficiency may be monitored against a reference PNC or against at least two other measurement PNCs. If the PNC reports particle number concentrations within ± 10 per cent of the arithmetic average of the concentrations from the reference PNC, or a group of two or more PNCs, the PNC shall subsequently be considered stable, otherwise maintenance of the PNC is required. Where the PNC is monitored against two or more other measurement PNCs, it is permitted to use a reference vehicle running sequentially in different test cells each with its own PNC.

Figure A5/16

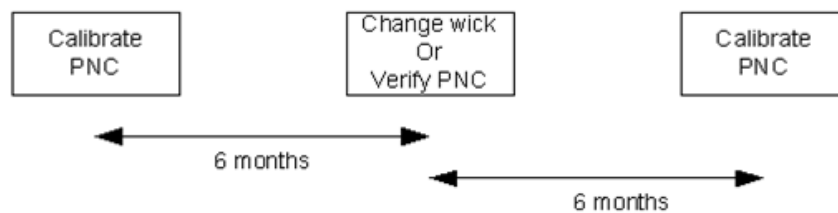
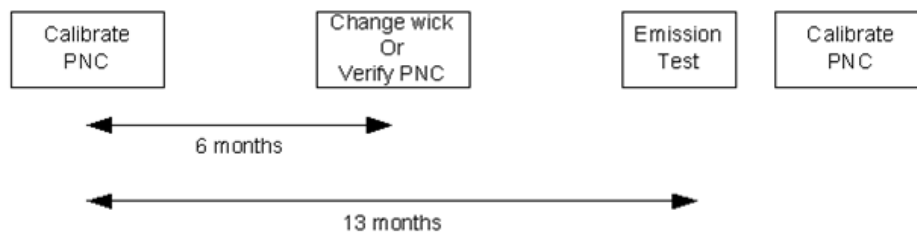
Nominal PNC annual sequence

Figure A5/17

Extended PNC annual sequence (in the case that a full PNC calibration is delayed)

- 5.7.1.2. The PNC shall also be recalibrated and a new calibration certificate issued following any major maintenance.
- 5.7.1.3. Calibration shall be traceable to a national or international standard calibration method by comparing the response of the PNC under calibration with that of:
- A calibrated aerosol electrometer when simultaneously sampling electrostatically classified calibration particles; or
 - A second PNC that has been directly calibrated by the method described above.
- 5.7.1.3.1. For the requirements of paragraph 5.7.1.3.(a), calibration shall be undertaken using at least six standard concentrations spaced as uniformly as possible across the PNC's measurement range.
- 5.7.1.3.2. For the requirements of paragraph 5.7.1.3.(b), calibration shall be undertaken using at least six standard concentrations across the PNC's measurement range. At least 3 points shall be at concentrations below 1,000 per cm³, the remaining concentrations shall be linearly spaced between 1,000 per cm³ and the maximum of the PNC's range in single particle count mode.
- 5.7.1.3.3. For the requirements of paragraphs 5.7.1.3.(a) and 5.7.1.3.(b), the selected points shall include a nominal zero concentration point produced by attaching HEPA filters of at least Class H13 of EN 1822:2008, or equivalent performance, to the inlet of each instrument. With no calibration factor applied

to the PNC under calibration, measured concentrations shall be within ± 10 per cent of the standard concentration for each concentration, with the exception of the zero point, otherwise the PNC under calibration shall be rejected. The gradient from a linear least squares regression of the two data sets shall be calculated and recorded. A calibration factor equal to the reciprocal of the gradient shall be applied to the PNC under calibration. Linearity of response is calculated as the square of the Pearson product moment correlation coefficient (r) of the two data sets and shall be equal to or greater than 0.97. In calculating both the gradient and r^2 , the linear regression shall be forced through the origin (zero concentration on both instruments).

5.7.1.4. Calibration shall also include a check, according to the requirements of paragraph 4.3.1.3.4.(h) of this annex, on the PNC's detection efficiency with particles of 23 nm electrical mobility diameter. A check of the counting efficiency with 41 nm particles is not required.

5.7.2. Calibration/validation of the VPR

5.7.2.1. Calibration of the VPR's particle concentration reduction factors across its full range of dilution settings, at the instrument's fixed nominal operating temperatures, shall be required when the unit is new and following any major maintenance. The periodic validation requirement for the VPR's particle concentration reduction factor is limited to a check at a single setting, typical of that used for measurement on particulate filter-equipped vehicles. The responsible authority shall ensure the existence of a calibration or validation certificate for the VPR within a 6-month period prior to the emissions test. If the VPR incorporates temperature monitoring alarms, a 13-month validation interval is permitted.

It is recommended that the VPR is calibrated and validated as a complete unit.

The VPR shall be characterised for particle concentration reduction factor with solid particles of 30, 50 and 100 nm electrical mobility diameter. Particle concentration reduction factors $f_r(d)$ for particles of 30 nm and 50 nm electrical mobility diameters shall be no more than 30 per cent and 20 per cent higher respectively, and no more than 5 per cent lower than that for particles of 100 nm electrical mobility diameter. For the purposes of validation, the arithmetic average of the particle concentration reduction factor shall be within ± 10 per cent of the arithmetic average particle concentration reduction factor \bar{f}_r determined during the primary calibration of the VPR.

5.7.2.2. The test aerosol for these measurements shall be solid particles of 30, 50 and 100 nm electrical mobility diameter and a minimum concentration of 5,000 particles per cm^3 at the VPR inlet. As an option, a polydisperse aerosol with an electrical mobility median diameter of 50 nm may be used for validation. The test aerosol shall be thermally stable at the VPR operating temperatures. Particle number concentrations shall be measured upstream and downstream of the components.

The particle concentration reduction factor for each monodisperse particle size, $f_r(d_i)$, shall be calculated using the following equation:

$$f_r(d_i) = \frac{N_{in}(d_i)}{N_{out}(d_i)}$$

where:

$N_{in}(d_i)$ is the upstream particle number concentration for particles of diameter d_i ;

$N_{out}(d_i)$ is the downstream particle number concentration for particles of diameter d_i ;

d_i is the particle electrical mobility diameter (30, 50 or 100 nm).

$N_{in}(d_i)$ and $N_{out}(d_i)$ shall be corrected to the same conditions.

The arithmetic average particle concentration reduction factor \bar{f}_r at a given dilution setting shall be calculated using the following equation:

$$\bar{f}_r = \frac{f_r(30\text{nm}) + f_r(50\text{nm}) + f_r(100\text{nm})}{3}$$

Where a polydisperse 50 nm aerosol is used for validation, the arithmetic average particle concentration reduction factor \bar{f}_v at the dilution setting used for validation shall be calculated using the following equation:

$$\bar{f}_v = \frac{N_{in}}{N_{out}}$$

where:

N_{in} is the upstream particle number concentration;

N_{out} is the downstream particle number concentration.

5.7.2.3. The VPR shall demonstrate greater than 99.0 per cent removal of tetracontane ($\text{CH}_3(\text{CH}_2)_{38}\text{CH}_3$) particles of at least 30 nm electrical mobility diameter with an inlet concentration $\geq 10,000$ per cm^3 when operated at its minimum dilution setting and manufacturer's recommended operating temperature.

5.7.3. PN measurement system check procedures

On a monthly basis, the flow into the PNC shall have a measured value within 5 per cent of the PNC nominal flow rate when checked with a calibrated flow meter.

5.8. Accuracy of the mixing device

In the case that a gas divider is used to perform the calibrations as defined in paragraph 5.2. of this annex, the accuracy of the mixing device shall be such that the concentrations of the diluted calibration gases may be determined to within ± 2 per cent. A calibration curve shall be verified by a mid-span check as described in paragraph 5.3. of this annex. A calibration gas with a concentration below 50 per cent of the analyser range shall be within 2 per cent of its certified concentration.

6. Reference gases

6.1. Pure gases

6.1.1. All values in ppm mean volume-ppm (vpm)

6.1.2. The following pure gases shall be available, if necessary, for calibration and operation:

6.1.2.1. Nitrogen:

Purity: ≤ 1 ppm C_1 , ≤ 1 ppm CO, ≤ 400 ppm CO_2 , ≤ 0.1 ppm NO, ≤ 0.1 ppm N_2O , ≤ 0.1 ppm NH_3 .

6.1.2.2. Synthetic air:

Purity: ≤ 1 ppm C_1 , ≤ 1 ppm CO, ≤ 400 ppm CO_2 , ≤ 0.1 ppm NO, ≤ 0.1 ppm NO_2 ; oxygen content between 18 and 21 per cent volume.

6.1.2.3. Oxygen:

Purity: > 99.5 per cent vol. O_2 .

6.1.2.4. Hydrogen (and mixture containing helium or nitrogen):

Purity: ≤ 1 ppm C_1 , ≤ 400 ppm CO_2 ; hydrogen content between 39 and 41 per cent volume.

6.1.2.5. Carbon monoxide:

Minimum purity 99.5 per cent.

6.1.2.6. Propane:

Minimum purity 99.5 per cent.

6.2. Calibration gases

The true concentration of a calibration gas shall be within ± 1 per cent of the stated value or as given below, and shall be traceable to national or international standards.

Mixtures of gases having the following compositions shall be available with bulk gas specifications according to paragraphs 6.1.2.1. or 6.1.2.2. of this annex:

- (a) C_3H_8 in synthetic air (see paragraph 6.1.2.2. of this annex);
- (b) CO in nitrogen;
- (c) CO_2 in nitrogen;
- (d) CH_4 in synthetic air;
- (e) NO in nitrogen (the amount of NO_2 contained in this calibration gas shall not exceed 5 per cent of the NO content).

Annex B6

Type 1 test procedures and test conditions

1. Description of tests
 - 1.1. The Type 1 test is used to verify the emissions of gaseous compounds, particulate matter, particle number (if PN measurement is required), CO₂ mass emission, fuel consumption, electric energy consumption and electric ranges over the applicable WLTP test cycle and OBF_{CM} accuracy (where applicable).
 - 1.1.1. The tests shall be carried out according to the method described in paragraph 2. of this annex or paragraph 3. of Annex B8 for pure electric, hybrid electric and compressed hydrogen fuel cell hybrid vehicles. Exhaust gases, particulate matter and particle number (if PN measurement is required) shall be sampled and analysed by the prescribed methods.
 - 1.1.2. When the reference fuel to be used is LPG or NG/biomethane, the following provisions shall apply additionally.
 - 1.1.2.1. Exhaust emissions approval of a parent vehicle
 - 1.1.2.1.1. The parent vehicle should demonstrate its capability to adapt to any fuel composition that may occur across the market. In the case of LPG there are variations in C3/C4 composition. In the case of NG/biomethane there are generally two types of fuel, high calorific fuel (H-gas) and low calorific fuel (Lgas), but with a significant spread within both ranges; they differ significantly in Wobbe index. These variations are reflected in the reference fuels.
 - 1.1.2.1.2. In the case of vehicles fuelled by LPG, NG/biomethane, the parent vehicle(s) shall be tested in the Type 1 test on the two extreme reference fuels of Annex B3. In the case of NG/biomethane, if the transition from one fuel to another is in practice aided through the use of a switch, this switch shall not be used during type approval. In such a case on the manufacturer's request and with the agreement of the approval authority the pre-conditioning cycle referred in paragraph 2.6. of Annex B6 may be extended.
 - 1.1.2.1.3. The vehicle is considered to conform if, under the tests and reference fuels mentioned in paragraph 1.1.2.1.2. of this annex, the vehicle complies with the emission limits.
 - 1.1.2.1.4. In the case of vehicles fuelled by LPG or NG/biomethane, the ratio of emission results "r" shall be determined for each pollutant as follows:

Type(s) of fuel	Reference fuels	Calculation of "r"
LPG and petrol or LPG only	Fuel A	$r = \frac{B}{A}$
	Fuel B	
NG/biomethane and petrol or NG/biomethane only	Fuel G ₂₀	$r = \frac{G_{25}}{G_{20}}$
	Fuel G ₂₅	

- 1.1.2.2. Exhaust emissions approval of a member of the family:

For the type approval of a mono fuel gas vehicle and bi fuel gas vehicles operating in gas mode, fuelled by LPG or NG/Biomethane, as a member of the family, a Type 1 test shall be performed with one gas reference fuel. This

reference fuel may be either of the gas reference fuels. The vehicle is considered to comply if the following requirements are met:

- 1.1.2.2.1. The vehicle complies with the definition of a family member as defined in paragraph 6.3.6.3. of this Regulation;
 - 1.1.2.2.2. If the test fuel is reference fuel A for LPG or G20 for NG/biomethane, the emission result shall be multiplied by the relevant factor "r" calculated in paragraph 3.1.4. of this annex if $r > 1$; if $r < 1$, no correction is needed;
 - 1.1.2.2.3. If the test fuel is reference fuel B for LPG or G25 for NG/biomethane, the emission result shall be divided by the relevant factor "r" calculated in paragraph 1.1.2.1.4. of this annex if $r < 1$; if $r > 1$, no correction is needed;
 - 1.1.2.2.4. On the manufacturer's request, the Type 1 test may be performed on both reference fuels, so that no correction is needed;
 - 1.1.2.2.5. The vehicle shall comply with the emission limits valid for the relevant category for both measured and calculated emissions;
 - 1.1.2.2.6. If repeated tests are made on the same engine the results on reference fuel G₂₀, or A, and those on reference fuel G₂₅, or B, shall first be averaged; the "r" factor shall then be calculated from these averaged results;
 - 1.1.2.2.7. Without prejudice to paragraph 2.6.4.1.2. of Annex B6, during the Type 1 test it is permissible to use petrol only or simultaneously with gas when operating in gas mode provided that the energy consumption of gas is higher than 80 per cent of the total amount of energy consumed during the test. This percentage shall be calculated in accordance with the method set out in Appendix 3 to this annex.
- 1.2. The number of tests shall be determined according to the flowchart in Figure A6/1. The limit value is the maximum allowed value for the respective criteria emission as specified in Table 1 of this Regulation.
 - 1.2.1. The flowchart in Figure A6/1 shall be applicable only to the whole applicable WLTP test cycle and not to single phases.
 - 1.2.2. The test results shall be the values after the applicable adjustments specified in the post-processing tables in Annex B7 and Annex B8 are applied.
 - 1.2.3. Determination of total cycle values
 - 1.2.3.1. If during any of the tests a criteria emissions limit is exceeded, the vehicle shall be rejected.
 - 1.2.3.2. Depending on the vehicle type, the manufacturer shall declare as applicable the total cycle value of the CO₂ mass emission, the electric energy consumption, fuel consumption, fuel efficiency, as well as PER and AER according to Table A6/1.
 - 1.2.3.3. For 4 phase WLTP test

The declared value of the electric energy consumption for OVC-HEVs under charge-depleting operating condition shall not be determined according to Figure A6/1. It shall be taken as the type approval value if the declared CO₂ value is accepted as the approval value. If that is not the case, the measured value of electric energy consumption shall be taken as the type approval value. Evidence of a correlation between declared CO₂ mass emission and electric energy consumption shall be submitted to the responsible authority in advance, if applicable.

For 3 phase WLTP test

The declared value of the fuel efficiency for OVC-HEVs under charge-depleting operating condition shall not be determined according to Figure A6/1. It shall be taken as the type approval value if the declared electric energy consumption value is accepted as the approval value. If that is not the case, the measured value of fuel efficiency shall be taken as the type approval value. Evidence of a correlation between declared fuel efficiency and electric

energy consumption shall be submitted to the responsible authority in advance, if applicable.

- 1.2.3.4. If after the first test all criteria in row 1 of the applicable Table A6/2 are fulfilled, all values declared by the manufacturer shall be accepted as the type approval value. If any one of the criteria in row 1 of the applicable Table A6/2 is not fulfilled, a second test shall be performed with the same vehicle.
- 1.2.3.5. After the second test, the arithmetic average results of the two tests shall be calculated. If all criteria in row 2 of the applicable Table A6/2 are fulfilled by these arithmetic average results, all values declared by the manufacturer shall be accepted as the type approval value. If any one of the criteria in row 2 of the applicable Table A6/2 is not fulfilled, a third test shall be performed with the same vehicle.
- 1.2.3.6. After the third test, the arithmetic average results of the three tests shall be calculated. For all parameters which fulfil the corresponding criterion in row 3 of the applicable Table A6/2, the declared value shall be taken as the type approval value. For any parameter which does not fulfil the corresponding criterion in row 3 of the applicable Table A6/2, the arithmetic average result shall be taken as the type approval value.
- 1.2.3.7. In the case that any one of the criterion of the applicable Table A6/2 is not fulfilled after the first or second test, at the request of the manufacturer and with the approval of the responsible authority, the values may be re-declared as higher values for emissions or consumption, or as lower values for electric ranges, in order to reduce the required number of tests for type approval.
- 1.2.3.8. Determination of the acceptance values
- 1.2.3.8.1. For 4 phase WLTP test only
- Additional to the requirement of paragraph 1.2.3.8.2., the following acceptance values for dCO_{21} , dCO_{22} and dCO_{23} shall be used in relation to the criteria for the number of tests in Table A6/2:
- For the CO_2 emissions from the 4 phases of a WLTP test;
- $$dCO_{21} = 0.990$$
- $$dCO_{22} = 0.995$$
- $$dCO_{23} = 1.000$$
- 1.2.3.8.2. For 4 phase WLTP test only:
- If the charge depleting Type 1 test for OVC-HEVs consists of two or more applicable WLTP test cycles and the dCO_{2x} value is below 1.0, the dCO_{2x} value shall be replaced by 1.0.
- 1.2.3.9. In the case that a test result or an average of test results was taken and confirmed as the type approval value, this result shall be referred to as the “declared value” for further calculations.

Table A6/1

Applicable rules for a manufacturer's declared values (total cycle values)^(a) (as applicable)

<i>Vehicle type</i>	For 4 phase WLTP test only <i>M_{CO2}</i> ^(b) (g/km)	For 4 phase WLTP test <i>FC</i> (kg/100 km)	For 3 phase WLTP test <i>FE</i> (km/l or km/kg)	<i>Electric energy consumption</i> ^(c) (Wh/km)	<i>All electric range / Pure Electric Range</i> ^(c) (km)
Vehicles tested according to Annex B6 (pure ICE)	<i>M_{CO2}</i> Paragraph 3. of Annex B7.	<i>FC</i> Paragraph 1.4. of Annex B7.	<i>FE</i> Paragraph 1.4. of Annex B7.	-	-
NOVC-FCHV	-	<i>FCs</i> Paragraph 4.2.1.2.1. of Annex B8.	<i>FEs</i> Paragraph 4.2.1.2.1. of Annex B8.	-	-
NOVC-HEV	<i>M_{CO2,CS}</i> Paragraph 4.1.1. of Annex B8.	-	<i>FEs</i> Paragraph 4.1.1.1. of Annex B8.	-	-
OVC-HEV	CD <i>M_{CO2,CD}</i> Paragraph 4.1.2. of Annex B8.	-	<i>FE_{CD}</i> Paragraph 4.6.1. of Annex B8.	For 4 phase WLTP test: <i>EC_{AC,CD}</i> Paragraph 4.3.1. of Annex B8. For 3 phase WLTP test: <i>EC</i> Paragraph 4.6.2. of Annex B8	<i>AER</i> Paragraph 4.4.1.1. of Annex B8.
	CS <i>M_{CO2,CS}</i> Paragraph 4.1.1. of Annex B8.	-	<i>FEs</i> Paragraph 4.1.1.1. of Annex B8.	-	-
PEV	-	-	-	<i>EC_{WLTC}</i> Paragraph 4.3.4.2. of Annex B8.	<i>PER_{WLTC}</i> Paragraph 4.4.2. of Annex B8.

^(a) The declared value shall be the value to which the necessary corrections, as applicable, are applied

^(b) Rounding to 2 places of decimal according to paragraph 6.1.8. of this Regulation

^(c) Rounding to one place of decimal according to paragraph 6.1.8. of this Regulation

Figure A6/1
Flowchart for the number of Type 1 tests

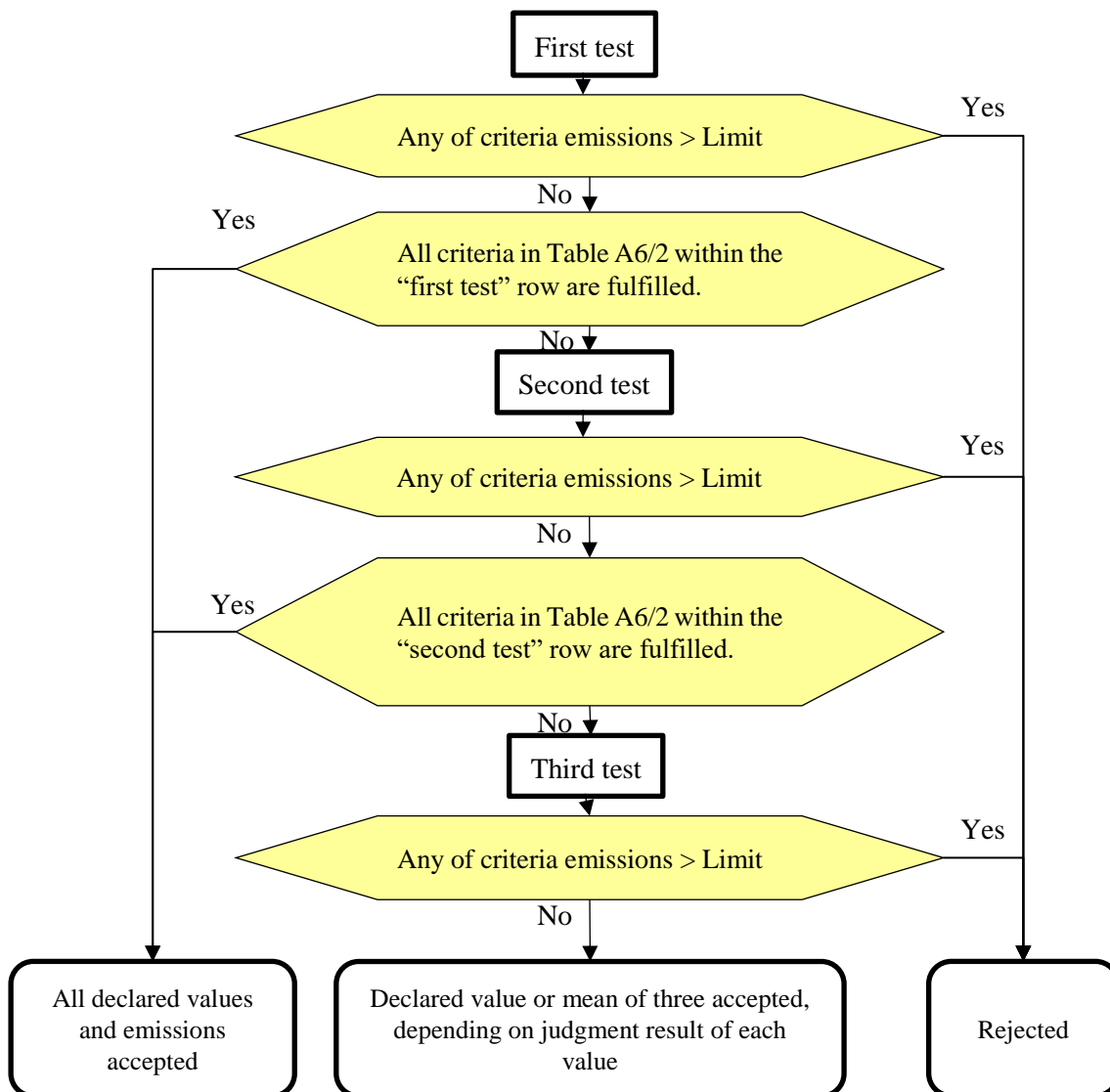


Table A6/2

Criteria for number of tests

For pure ICE vehicles, NOVC-HEVs and OVC-HEVs charge-sustaining Type 1 test.

	<i>Test</i>	<i>Judgement parameter</i>	<i>Criteria emission</i>	For 4 phase WLTP test: M_{CO_2}	For 3 phase WLTP test: FE
Row 1	First test	First test results	\leq Regulation limit $\times 0.9$	\leq Declared value $\times dCO_{21}^{(b)}$	\geq Declared value $\times 1.0$
Row 2	Second test	Arithmetic average of the first and second test results	\leq Regulation limit $\times 1.0^{(a)}$	\leq Declared value $\times dCO_{22}^{(b)}$	\geq Declared value $\times 1.0$
Row 3	Third test	Arithmetic average of three test results	\leq Regulation limit $\times 1.0^{(a)}$	\leq Declared value $\times dCO_{23}^{(b)}$	\geq Declared value $\times 1.0$

^(a) Each test result shall fulfil the regulation limit.^(b) dCO_{21} , dCO_{22} , and dCO_{23} shall be determined according to paragraph 1.2.3.8. of this annex

For OVC-HEVs charge-depleting Type 1 test.

	<i>Test</i>	<i>Judgement parameter</i>	<i>Criteria emissions</i>	For 4 phase WLTP test: $M_{CO_2,CD}$	For 3 phase WLTP test: EC	For 4 phase WLTP test: AER
Row 1	First test	First test results	\leq Regulation limit $\times 0.9^{(a)}$	\leq Declared value $\times dCO_{21}^{(c)}$	\leq Declared value $\times 1.0$	\geq Declared value $\times 1.0$
Row 2	Second test	Arithmetic average of the first and second test results	\leq Regulation limit $\times 1.0^{(b)}$	\leq Declared value $\times dCO_{22}^{(c)}$	\leq Declared value $\times 1.0$	\geq Declared value $\times 1.0$
Row 3	Third test	Arithmetic average of three test results	\leq Regulation limit $\times 1.0^{(b)}$	\leq Declared value $\times dCO_{23}^{(c)}$	\leq Declared value $\times 1.0$	\geq Declared value $\times 1.0$

^(a) "0.9" shall be replaced by "1.0" for charge-depleting Type 1 test for OVC-HEVs, only if the charge-depleting test contains two or more applicable WLTC cycles.^(b) Each test result shall fulfil the regulation limit.^(c) dCO_{21} , dCO_{22} and dCO_{23} shall be determined according to paragraph 1.2.3.8. of this annex.

For PEVs

	<i>Test</i>	<i>Judgement parameter</i>	<i>Electric energy consumption</i>	<i>PER</i>
Row 1	First test	First test results	\leq Declared value $\times 1.0$	\geq Declared value $\times 1.0$
Row 2	Second test	Arithmetic average of the first and second test results	\leq Declared value $\times 1.0$	\geq Declared value $\times 1.0$
Row 3	Third test	Arithmetic average of three test results	\leq Declared value $\times 1.0$	\geq Declared value $\times 1.0$

For NOVC-FCHVs

	<i>Test</i>	<i>Judgement parameter</i>	For 4 phase WLTP test: FC_{CS} (upper value)	For 3 phase WLTP test: FE_{CS} (lower value)
Row 1	First test	First test results	\leq Declared value \times 1.0	\geq Declared value \times 1.0
Row 2	Second test	Arithmetic average of the first and second test results	\leq Declared value \times 1.0	\geq Declared value \times 1.0
Row 3	Third test	Arithmetic average of three test results	\leq Declared value \times 1.0	\geq Declared value \times 1.0

1.2.4. Determination of phase-specific values

1.2.4.1. Phase-specific value for CO₂

1.2.4.1.1. After the total cycle declared value of the CO₂ mass emission is accepted, the arithmetic average of the phase-specific values of the test results in g/km shall be multiplied by the adjustment factor CO₂_AF to compensate for the difference between the declared value and the test results. This corrected value shall be the type approval value for CO₂.

$$CO_2_AF = \frac{\text{Declared value}}{\text{Phase combined value}}$$

where:

$$\text{Phase combined value} = \frac{(CO_{2\text{aveL}} \times D_L) + (CO_{2\text{aveM}} \times D_M) + (CO_{2\text{aveH}} \times D_H) + (CO_{2\text{aveexH}} \times D_{\text{exH}})}{D_L + D_M + D_H + D_{\text{exH}}}$$

where:

$CO_{2\text{aveL}}$ is the arithmetic average CO₂ mass emission result for the L phase test result(s), g/km;

$CO_{2\text{aveM}}$ is the arithmetic average CO₂ mass emission result for the M phase test result(s), g/km;

$CO_{2\text{aveH}}$ is the arithmetic average CO₂ mass emission result for the H phase test result(s), g/km;

$CO_{2\text{aveexH}}$ is the arithmetic average CO₂ mass emission result for the exH phase test result(s), g/km;

D_L is theoretical distance of phase L, km;

D_M is theoretical distance of phase M, km;

D_H is theoretical distance of phase H, km;

D_{exH} is theoretical distance of phase exH, km.

1.2.4.1.2. If the total cycle declared value of the CO₂ mass emission is not accepted, the type approval phase-specific CO₂ mass emission value shall be calculated by taking the arithmetic average of the all test results for the respective phase.

1.2.4.2. Phase-specific values for fuel consumption

The fuel consumption value shall be calculated by the phase-specific CO₂ mass emission using the equations in paragraph 1.2.4.1. of this annex and the arithmetic average of the emissions.

2. Type 1 test
 - 2.1. Overview
 - 2.1.1. The Type 1 test shall consist of prescribed sequences of dynamometer preparation, fuelling, soaking, and operating conditions.
 - 2.1.2. The Type 1 test shall consist of vehicle operation on a chassis dynamometer on the applicable WLTC for the interpolation family. A proportional part of the diluted exhaust emissions shall be collected continuously for subsequent analysis using a constant volume sampler.
 - 2.1.3. Background concentrations shall be measured for all compounds for which dilute mass emissions measurements are conducted. For exhaust emissions testing, this requires sampling and analysis of the dilution air.
 - 2.1.3.1. Background particulate measurement
 - 2.1.3.1.1. Where the manufacturer requests subtraction of either dilution air or dilution tunnel background particulate mass from emissions measurements, these background levels shall be determined according to the procedures listed in paragraphs 2.1.3.1.1.1. to 2.1.3.1.1.3. inclusive of this annex.
 - 2.1.3.1.1.1. The maximum permissible background correction shall be a mass on the filter equivalent to 1 mg/km at the flow rate of the test.
 - 2.1.3.1.1.2. If the background exceeds this level, the default figure of 1 mg/km shall be subtracted.
 - 2.1.3.1.1.3. Where subtraction of the background contribution gives a negative result, the background level shall be considered to be zero.
 - 2.1.3.1.2. Dilution air background particulate mass level shall be determined by passing filtered dilution air through the particulate background filter. This shall be drawn from a point immediately downstream of the dilution air filters. Background levels in $\mu\text{g}/\text{m}^3$ shall be determined as a rolling arithmetic average of at least 14 measurements with at least one measurement per week.
 - 2.1.3.1.3. Dilution tunnel background particulate mass level shall be determined by passing filtered dilution air through the particulate background filter. This shall be drawn from the same point as the particulate matter sample. Where secondary dilution is used for the test, the secondary dilution system shall be active for the purposes of background measurement. One measurement may be performed on the day of test, either prior to or after the test.
 - 2.1.3.2. Background particle number determination (if PN measurement is required)
 - 2.1.3.2.1. Where a manufacturer requests a background correction, these background levels shall be determined as follows:
 - 2.1.3.2.1.1. The background value may be either calculated or measured. The maximum permissible background correction shall be related to the maximum allowable leak rate of the particle number measurement system (0.5 particles per cm^3) scaled from the particle concentration reduction factor, PCRF, and the CVS flow rate used in the actual test;
 - 2.1.3.2.1.2. Either the responsible authority or the manufacturer may request that actual background measurements are used instead of calculated ones.
 - 2.1.3.2.1.3. Where subtraction of the background contribution gives a negative result, the PN result shall be considered to be zero.
 - 2.1.3.2.2. The dilution air background particle number level shall be determined by sampling filtered dilution air. This shall be drawn from a point immediately downstream of the dilution air filters into the PN measurement system. Background levels in particles per cm^3 shall be determined as a rolling arithmetic average of at least 14 measurements with at least one measurement per week.

- 2.1.3.2.3. The dilution tunnel background particle number level shall be determined by sampling filtered dilution air. This shall be drawn from the same point as the PN sample. Where secondary dilution is used for the test the secondary dilution system shall be active for the purposes of background measurement. One measurement may be performed on the day of test, either prior to or after the test using the actual PCRF and the CVS flow rate utilised during the test.
- 2.2. General test cell equipment
- 2.2.1. Parameters to be measured
- 2.2.1.1. The following temperatures shall be measured with an accuracy of ± 1.5 °C:
- (a) Test cell ambient air;
 - (b) Dilution and sampling system temperatures as required for emissions measurement systems defined in Annex B5.
- 2.2.1.2. Atmospheric pressure shall be measurable with a precision of ± 0.1 kPa.
- 2.2.1.3. Specific humidity H shall be measurable with a precision of ± 1 g H₂O/kg dry air.
- 2.2.2. Test cell and soak area
- 2.2.2.1. Test cell
- 2.2.2.1.1. The test cell shall have a temperature set point of 23 °C. The tolerance of the actual value shall be within ± 5 °C. The air temperature and humidity shall be measured at the test cell's cooling fan outlet at a minimum frequency of 0.1 Hz. For the temperature at the start of the test, see paragraph 2.8.1. of this annex.
- 2.2.2.1.2. The specific humidity H of either the air in the test cell or the intake air of the engine shall be such that:
- $$5.5 \leq H \leq 12.2 \text{ (g H}_2\text{O/kg dry air)}$$
- 2.2.2.1.3. Humidity shall be measured continuously at a minimum frequency of 0.1 Hz.
- 2.2.2.2. Soak area
- The soak area shall have a temperature set point of 23 °C and the tolerance of the actual value shall be within ± 3 °C on a 5-minute running arithmetic average and shall not show a systematic deviation from the set point. The temperature shall be measured continuously at a minimum frequency of 0.033 Hz (every 30 s).
- 2.3. Test vehicle
- 2.3.1. General
- The test vehicle shall conform in all its components with the production series, or, if the vehicle is different from the production series (e.g. for worst case testing), a full description shall be recorded. In selecting the test vehicle, the manufacturer and the responsible authority shall agree which vehicle model is representative for the interpolation family.
- In the case that vehicles within an interpolation family are equipped with different emission control systems that could have an effect on the emission behaviour, the manufacturer shall either demonstrate to the responsible authority that the test vehicle(s) selected and its (their) results from the Type 1 test are representative for the interpolation family, or demonstrate the fulfilment of the criteria emission within the interpolation family by testing one or more individual vehicles that differ in their emission control systems.
- For the measurement of emissions, the road load as determined with test vehicle H shall be applied. In the case of a road load matrix family, for the measurement of emissions, the road load as calculated for vehicle H_M according to paragraph 5.1. of Annex B4 shall be applied.

If at the request of the manufacturer the interpolation method is used (see paragraph 3.2.3.2. of Annex B7), an additional measurement of emissions shall be performed with the road load as determined with test vehicle L. Tests on vehicles H and L should be performed with the same test vehicle and shall be tested with the shortest n/v ratio (with a tolerance of ± 1.5 per cent) within the interpolation family. In the case of a road load matrix family, an additional measurement of emissions shall be performed with the road load as calculated for vehicle L_M according to paragraph 5.1. of Annex B4.

Road load coefficients and the test mass of test vehicle L and H may be taken from different road load matrix families. They may also be taken from different road load families as long as the difference between these road load families has been demonstrated to and accepted by the responsible authority, and results from either applying paragraph 6.8. of Annex B4 or tyres taken from different tyre categories, while the requirements in paragraph 2.3.2. of this annex are maintained.

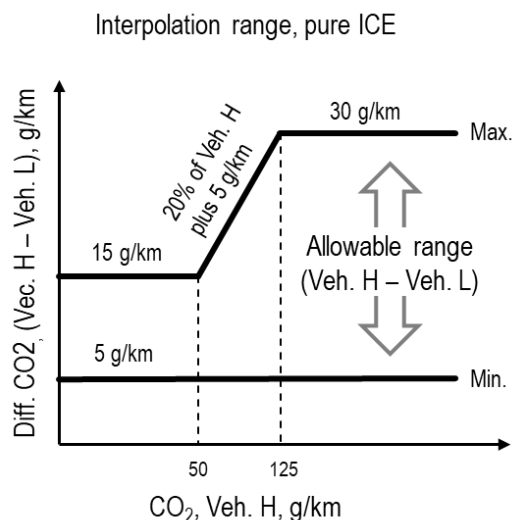
2.3.2. CO₂ interpolation range

2.3.2.1. The interpolation method shall only be used if the difference in CO₂ over the applicable cycle resulting from step 9 in Table A7/1 of Annex B7 between test vehicles L and H is between a minimum of 5 g/km and a maximum defined in paragraph 2.3.2.2. of this annex.

2.3.2.2. The maximum difference in CO₂ emissions allowed over the applicable cycle resulting from step 9 in Table A7/1 of Annex B7 between test vehicles L and H shall be 20 per cent plus 5 g/km of the CO₂ emissions from vehicle H, but at least 15 g/km and not exceeding 30 g/km. See Figure A6/2.

Figure A6/2

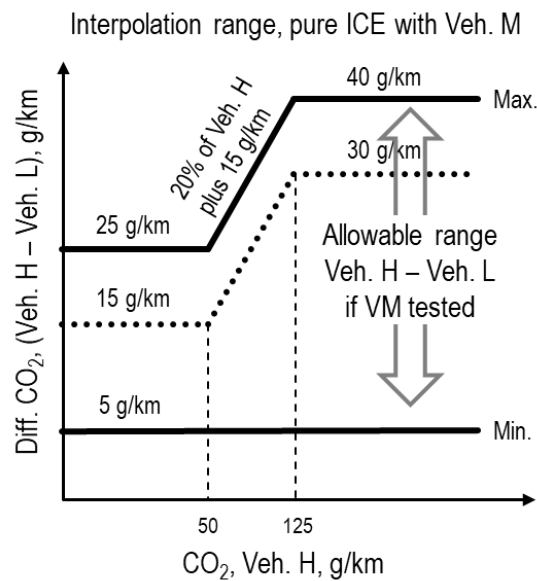
Interpolation range for pure ICE vehicles



This restriction does not apply for the application of a road load matrix family or when the calculation of the road load of vehicles L and H is based on the default road load.

2.3.2.2.1. The allowed interpolation range defined in paragraph 2.3.2.2. of this annex may be increased by 10 g/km CO₂ (see Figure A6/3) if a vehicle M is tested within that family and the conditions according to paragraph 2.3.2.4. of this annex are fulfilled. This increase is allowed only once within an interpolation family.

Figure A6/3

Interpolation range for pure ICE vehicles with vehicle M

- 2.3.2.3. At the request of the manufacturer and with approval of the responsible authority, the application of the interpolation method on individual vehicle values within a family may be extended if the maximum extrapolation of an individual vehicle (Step 10 in Table A7/1 of Annex B7) is not more than 3 g/km above the CO₂ emission of vehicle H (Step 9 in Table A7/1 of Annex B7) and/or is not more than 3 g/km below the CO₂ emission of vehicle L (Step 9 in Table A7/1 of Annex B7). This extrapolation is valid only within the absolute boundaries of the interpolation range specified in paragraph 2.3.2.2.

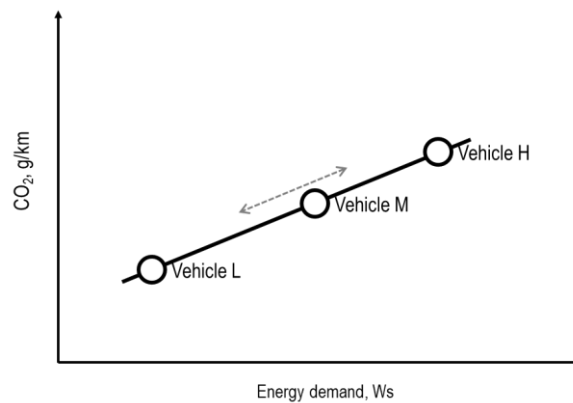
For the application of a road load matrix family, or when the calculation of the road load of vehicles L and H is based on the default road load, extrapolation is not permitted.

- 2.3.2.4. Vehicle M

Vehicle M is a vehicle within the interpolation family between the vehicles L and H with a cycle energy demand which is preferably closest to the average of vehicles L and H.

The limits of the selection of vehicle M (see Figure A6/4) are such that neither the difference in CO₂ emission values between vehicles H and M nor the difference in CO₂ emission values between vehicles M and L is greater the allowed CO₂ range in accordance with paragraph 2.3.2.2. of this annex. The defined road load coefficients and the defined test mass shall be recorded.

Figure A6/4
Limits for the selection of vehicle M

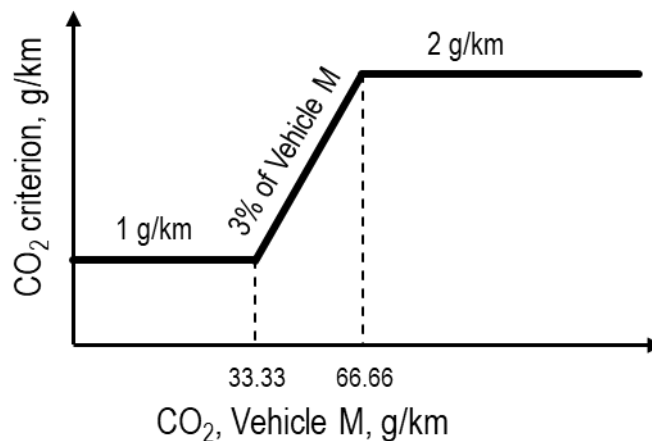


The linearity of CO₂ mass emission for vehicle M shall be verified against the linearly interpolated CO₂ mass emission between vehicles L and H over the applicable cycle by using the corrected measured values referring to the step used in Table 7/1 of Annex B7.

The linearity criterion for vehicle M (see Figure A6/5) shall be considered fulfilled, if the CO₂ mass emission of the vehicle M over the applicable WLTC minus the CO₂ mass emission derived by interpolation is less than 2 g/km or 3 per cent of the interpolated value, whichever value is lower, but at least 1 g/km.

Figure A6/5
Linearity criterion for vehicle M

Tolerance, Vehicle M measured vs. calculated



If the linearity criterion is fulfilled, the CO₂ values of individual vehicles shall be interpolated between vehicles L and H.

If the linearity criterion is not fulfilled, the interpolation family shall be split into two sub-families for vehicles with a cycle energy demand between vehicles L and M, and vehicles with a cycle energy demand between vehicles M and H. In such a case, the final CO₂ mass emissions of vehicle M shall be determined in accordance with the same process as for vehicles L or H. See step 9 in Table 7/1 of Annex B7.

For vehicles with a cycle energy demand between that of vehicles L and M, each parameter of vehicle H necessary for the application of the interpolation method on individual values shall be substituted by the corresponding parameter of vehicle M.

For vehicles with a cycle energy demand between that of vehicles M and H, each parameter of vehicle L necessary for the application of the interpolation method on individual values shall be substituted by the corresponding parameter of vehicle M.

2.3.3. Run-in

The vehicle shall be presented in good technical condition. It shall have been run-in and driven between 3,000 and 15,000 km before the test. The engine, transmission and vehicle shall be run-in in accordance with the manufacturer's recommendations.

2.4. Settings

2.4.1. Dynamometer settings and verification shall be performed according to Annex B4.

2.4.2. Dynamometer operation

2.4.2.1. Auxiliary devices shall be switched off or deactivated during dynamometer operation unless their operation is required by legislation (e.g. daylight running lamps).

2.4.2.1.1. If the vehicle is equipped with a coasting functionality, this functionality shall be deactivated either by a switch or by the vehicle's dynamometer operation mode during chassis dynamometer testing, except for tests where the coasting functionality is explicitly required by the test procedure.

2.4.2.2. The vehicle's dynamometer operation mode, if any, shall be activated by using the manufacturer's instruction (e.g. using vehicle steering wheel buttons in a special sequence, using the manufacturer's workshop tester, removing a fuse).

The manufacturer shall provide the responsible authority a list of the deactivated devices and/or functionalities and justification for the deactivation. The dynamometer operation mode shall be approved by the responsible authority and the use of a dynamometer operation mode shall be recorded.

2.4.2.3. The vehicle's dynamometer operation mode shall not activate, modulate, delay or deactivate the operation of any part (with the exclusion of the coasting functionality) that affects the emissions and fuel consumption under the test conditions. Any device that affects the operation on a chassis dynamometer shall be set to ensure a proper operation.

2.4.2.4. Allocation of dynamometer type to test vehicle

2.4.2.4.1. If the test vehicle has two powered axles, and under WLTP conditions it is partially or permanently operated with two axles being powered or recuperating energy over the applicable cycle the vehicle shall be tested on a dynamometer in 4WD operation which fulfils the specifications in paragraphs 2.2. and 2.3. of Annex B5.

2.4.2.4.2. If the test vehicle is tested with only one powered axle, the test vehicle shall be tested on a dynamometer in 2WD operation which fulfils the specifications in paragraph 2.2. of Annex B5.

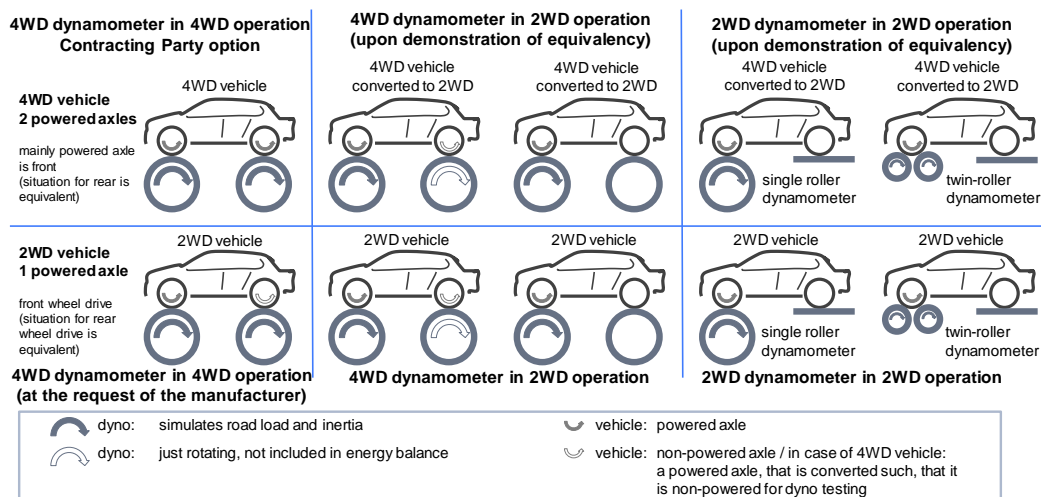
At the request of the manufacturer and with the approval of the approval authority a vehicle with one powered axle may be tested on a 4WD dynamometer in 4WD operation mode.

2.4.2.4.3. If the test vehicle is operated with two axles being powered in dedicated driver-selectable modes which are not intended for normal daily operation but only for special limited purposes, such as 'mountain mode' or 'maintenance mode', or when the mode with two powered axles is only activated in an off-road situation, the vehicle shall be tested on a dynamometer in 2WD operation which fulfils the specifications in paragraph 2.2. of Annex B5.

At the request of the manufacturer and with the approval of the approval authority, the vehicle may be tested on a 4WD dynamometer in 4WD operation mode.

- 2.4.2.4.4. If the test vehicle is tested on a 4WD dynamometer in 2WD operation the wheels on the non-powered axle may rotate during the test, provided that the vehicle dynamometer operation mode and vehicle coastdown mode support this way of operation.

Figure A6/5a
Possible test configurations on 2WD and 4WD dynamometers



- 2.4.2.5. Demonstration of equivalency between a dynamometer in 2WD operation and a dynamometer in 4WD operation

- 2.4.2.5.1. At the request of the manufacturer and with the approval of the approval authority, the vehicle which has to be tested on a dynamometer in 4WD operation may alternatively be tested on a dynamometer in 2WD operation if the following conditions are met:

- (a) the test vehicle is converted to have only one powered axle;
- (b) the manufacturer demonstrates to the approval authority that the CO₂, fuel consumption and/or electrical energy consumption of the converted vehicle is the same or higher as for the non-converted vehicle being tested on a dynamometer in 4WD operation;
- (c) a safe operation is ensured for the test (e.g. by removing a fuse or dismantling a drive shaft) and an instruction is provided together with the dynamometer operation mode;
- (d) the conversion is only applied to the vehicle tested at the chassis dynamometer, the road load determination procedure shall be applied to the unconverted test vehicle.

- 2.4.2.5.2. This demonstration of equivalency shall apply to all vehicles in the same road load family. At the request of the manufacturer, and with approval of the approval authority, this demonstration of equivalency may be extended to other road load families upon evidence that a vehicle from the worst-case road load family was selected as the test vehicle.

- 2.4.2.6. Information on whether the vehicle was tested on a 2WD dynamometer or a 4WD dynamometer and whether it was tested on a dynamometer in 2WD operation or 4WD operation shall be included in all relevant test reports. In the case that the vehicle was tested on a 4WD dynamometer, with that

- dynamometer in 2WD operation, this information shall also indicate whether or not the wheels on the non-powered wheels were rotating.
- 2.4.3. The vehicle's exhaust system shall not exhibit any leak likely to reduce the quantity of gas collected.
- 2.4.4. The settings of the powertrain and vehicle controls shall be those prescribed by the manufacturer for series production.
- 2.4.5. Tyres shall be of a type specified as original equipment by the vehicle manufacturer. Tyre pressure may be increased by up to 50 per cent above the pressure specified in paragraph 4.2.2.3. of Annex B4. The same tyre pressure shall be used for the setting of the dynamometer and for all subsequent testing. The tyre pressure used shall be recorded.
- 2.4.6. Reference fuel
The appropriate reference fuel as specified in Annex B3 shall be used for testing.
- 2.4.7. Test vehicle preparation
- 2.4.7.1. The vehicle shall be approximately horizontal during the test so as to avoid any abnormal distribution of the fuel.
- 2.4.7.2. If necessary, the manufacturer shall provide additional fittings and adapters, as required to accommodate a fuel drain at the lowest point possible in the tank(s) as installed on the vehicle, and to provide for exhaust sample collection.
- 2.4.7.3. For PM sampling during a test when the regenerating device is in a stabilized loading condition (i.e. the vehicle is not undergoing a regeneration), it is recommended that the vehicle has completed more than 1/3 of the mileage between scheduled regenerations or that the periodically regenerating device has undergone equivalent loading off the vehicle.
- 2.5. Preliminary testing cycles
Preliminary testing cycles may be carried out if requested by the manufacturer to follow the speed trace within the prescribed limits.
- 2.6. Test vehicle preconditioning
- 2.6.1. Vehicle preparation
- 2.6.1.1. Fuel tank filling
The fuel tank(s) shall be filled with the specified test fuel. If the existing fuel in the fuel tank(s) does not meet the specifications contained in paragraph 2.4.6. of this annex, the existing fuel shall be drained prior to the fuel fill. The evaporative emission control system shall neither be abnormally purged nor abnormally loaded.
- 2.6.1.2. REESSs charging
Before the preconditioning test cycle, the REESSs shall be fully charged. At the request of the manufacturer, charging may be omitted before preconditioning. The REESSs shall not be charged again before official testing.
- 2.6.1.3. Tyre pressures
The tyre pressure of the driving wheels shall be set in accordance with paragraph 2.4.5. of this annex.
- 2.6.1.4. Gaseous fuel vehicles
Between the tests on the first gaseous reference fuel and the second gaseous reference fuel, for vehicles with positive ignition engines fuelled with LPG or NG/biomethane or so equipped that they can be fuelled with either petrol or LPG or NG/biomethane, the vehicle shall be preconditioned again before the

test on the second reference fuel. Between the tests on the first gaseous reference fuel and the second gaseous reference fuel, for vehicles with positive ignition engines fuelled with LPG or NG/biomethane or so equipped that they can be fuelled with either petrol or LPG or NG/biomethane, the vehicle shall be preconditioned again before the test on the second reference fuel.

2.6.2. Test cell

2.6.2.1. Temperature

During preconditioning, the test cell temperature shall be the same as defined for the Type 1 test (paragraph 2.2.2.1.1. of this annex).

2.6.2.2. Background measurement

In a test facility in which there may be possible contamination of a low particulate emitting vehicle test with residue from a previous test on a high particulate emitting vehicle, it is recommended, for the purpose of sampling equipment preconditioning, that a 120 km/h steady state drive cycle of 20 minutes duration be driven by a low particulate emitting vehicle. Longer and/or higher speed running is permissible for sampling equipment preconditioning if required. Dilution tunnel background measurements, if applicable, shall be taken after the tunnel preconditioning, and prior to any subsequent vehicle testing.

2.6.3. Procedure

2.6.3.1. The test vehicle shall be placed, either by being driven or pushed, on a dynamometer and operated through the applicable WLTCs. The vehicle need not be cold, and may be used to set the dynamometer load.

2.6.3.2. The dynamometer load shall be set according to paragraphs 7. and 8. of Annex B4. In the case that a dynamometer in 2WD operation is used for testing, the road load setting shall be carried out on a dynamometer in 2WD operation, and in the case that a dynamometer in 4WD operation is used for testing the road load setting shall be carried out on a dynamometer in 4WD operation.

2.6.4. Operating the vehicle

2.6.4.1. The powertrain start procedure shall be initiated by means of the devices provided for this purpose according to the manufacturer's instructions.

A non-vehicle initiated switching of mode of operation during the test shall not be permitted unless otherwise specified.

2.6.4.1.1. If the initiation of the powertrain start procedure is not successful, e.g. the engine does not start as anticipated or the vehicle displays a start error, the test is void, preconditioning tests shall be repeated and a new test shall be driven.

2.6.4.1.2. In the cases where LPG or NG/biomethane is used as a fuel, it is permissible that the engine is started on petrol and switched automatically to LPG or NG/biomethane after a predetermined period of time that cannot be changed by the driver. This period of time shall not exceed 60 seconds.

It is also permissible to use petrol only or simultaneously with gas when operating in gas mode provided that the energy consumption of gas is higher than 80 per cent of the total amount of energy consumed during the Type 1 test. This percentage shall be calculated in accordance with the method set out in Appendix 3 to this annex.

2.6.4.2. The cycle starts on initiation of the powertrain start procedure.

2.6.4.3. For preconditioning, the applicable WLTC shall be driven.

At the request of the manufacturer or the responsible authority, additional WLTCs may be performed in order to bring the vehicle and its control systems to a stabilized condition.

The extent of such additional preconditioning shall be included in all relevant test reports.

2.6.4.4. Accelerations

The vehicle shall be operated with the necessary accelerator control movement to accurately follow the speed trace.

The vehicle shall be operated smoothly following representative shift speeds and procedures.

For manual transmissions, the accelerator control shall be released during each shift and the shift shall be accomplished in minimum time.

If the vehicle cannot follow the speed trace, it shall be operated at maximum available power until the vehicle speed reaches the respective target speed again.

2.6.4.5. Deceleration

During decelerations, the driver shall deactivate the accelerator control but shall not manually disengage the clutch until the point specified in paragraphs 3.3. or 4.(f) of Annex B2.

If the vehicle decelerates faster than prescribed by the speed trace, the accelerator control shall be operated such that the vehicle accurately follows the speed trace.

If the vehicle decelerates too slowly to follow the intended deceleration, the brakes shall be applied such that it is possible to accurately follow the speed trace.

2.6.4.6. Brake application

During stationary/idling vehicle phases, the brakes shall be applied with appropriate force to prevent the drive wheels from turning.

2.6.5. Use of the transmission

2.6.5.1. Manual shift transmissions

2.6.5.1.1. The gear shift prescriptions specified in Annex B2 shall be followed. Vehicles tested according to Annex B8 shall be driven according to paragraph 1.5. of that annex.

2.6.5.1.2. The gear change shall be started and completed within ± 1.0 second of the prescribed gear shift point.

2.6.5.1.3. The clutch shall be depressed within ± 1.0 second of the prescribed clutch operating point.

2.6.5.2. Automatic shift transmissions

2.6.5.2.1. After initial engagement, the selector shall not be operated at any time during the test. Initial engagement shall be done 1 second before beginning the first acceleration.

2.6.5.2.2. Vehicles with an automatic transmission with a manual mode shall not be tested in manual mode.

2.6.6. Driver-selectable modes

2.6.6.1. Vehicles equipped with a predominant mode shall be tested in that mode. At the request of the manufacturer, the vehicle may alternatively be tested with the driver-selectable mode in the worst-case position for CO₂ emissions.

The manufacturer shall provide evidence to the responsible authority of the existence of a mode that fulfils the requirements of paragraph 3.5.9. of this Regulation. With the agreement of the responsible authority, the predominant

mode may be used as the only mode for the determination of criteria emissions, CO₂ emissions, and fuel consumption.

- 2.6.6.2. If the vehicle has no predominant mode because it has two or more configurable start modes, the worst case mode for CO₂ emissions and fuel consumption within those configurable start modes shall be tested and may be used as the only mode for the determination of criteria emissions, CO₂ emissions and fuel consumption.
- 2.6.6.3. If the vehicle has no predominant mode or the requested predominant mode is not agreed by the responsible authority as being a predominant mode, or there are not two or more configurable start modes, the vehicle shall be tested for criteria emissions, CO₂ emissions, and fuel consumption in the best case mode and worst case mode. Best and worst case modes shall be identified by the evidence provided on the CO₂ emissions and fuel consumption in all modes. CO₂ emissions and fuel consumption shall be the arithmetic average of the test results in both modes. Test results for both modes shall be recorded.
- At the request of the manufacturer, the vehicle may alternatively be tested with the driver-selectable mode in the worst case position for CO₂ emissions.
- 2.6.6.4. On the basis of technical evidence provided by the manufacturer and with the agreement of the responsible authority, the dedicated driver-selectable modes for very special limited purposes shall not be considered (e.g. maintenance mode, crawler mode). All remaining modes used for forward driving shall be considered and the criteria emissions limits shall be fulfilled in all these modes.
- 2.6.6.5. Paragraphs 2.6.6.1. to 2.6.6.4. inclusive of this annex shall apply to all vehicle systems with driver-selectable modes, including those not solely specific to the transmission.
- 2.6.7. Voiding of the Type 1 test and completion of the cycle
- If the engine stops unexpectedly, the preconditioning or Type 1 test shall be declared void.
- After completion of the cycle, the engine shall be switched off. The vehicle shall not be restarted until the beginning of the test for which the vehicle has been preconditioned.
- 2.6.8. Data required, quality control
- 2.6.8.1. Speed measurement
- During the preconditioning, speed shall be measured against time or collected by the data acquisition system at a frequency of not less than 1 Hz so that the actual driven speed can be assessed.
- 2.6.8.2. Distance travelled
- The distance actually driven by the vehicle shall be recorded for each WLTC phase.
- 2.6.8.3. Speed trace tolerances
- Vehicles that cannot attain the acceleration and maximum speed values required in the applicable WLTC shall be operated with the accelerator control fully activated until they once again reach the required speed trace. Speed trace violations under these circumstances shall not void a test. Deviations from the driving cycle shall be recorded.
- 2.6.8.3.1. Unless otherwise stated in the specific sections, the following tolerances shall be permitted between the actual vehicle speed and the prescribed speed of the applicable test cycles based on the driving events:

2.6.8.3.1.1. Tolerance (1)

- (a) Upper limit: 2.0 km/h higher than the highest point of the trace within ± 5.0 second of the given point in time;
- (b) Lower limit: 2.0 km/h lower than the lowest point of the trace within ± 5.0 second of the given time.

2.6.8.3.1.2. Tolerance (2)

- (a) Upper limit: 2.0 km/h higher than the highest point of the trace within ± 1.0 second of the given point in time;
- (b) Lower limit: 2.0 km/h lower than the lowest point of the trace within ± 1.0 second of the given time.
 - (i) Speed tolerances greater than those prescribed shall be accepted provided the tolerances are never exceeded for more than 1 second on any one occasion.
 - (ii) There shall be no more than ten such deviations per test cycle.

2.6.8.3.1.3. Tolerance (3)

IWR	in the range of $- 2.0$ to $+ 4.0$ per cent
RMSSE	less than 0.8 km/h

2.6.8.3.1.4. Tolerance (4)

IWR	in the range of $- 2.0$ to $+ 4.0$ per cent
RMSSE	manufacture declared criteria but shall not be greater than 1.3 km/h

IWR and RMSSE drive trace indices shall be calculated in accordance with the requirements of paragraph 7. of Annex B7.

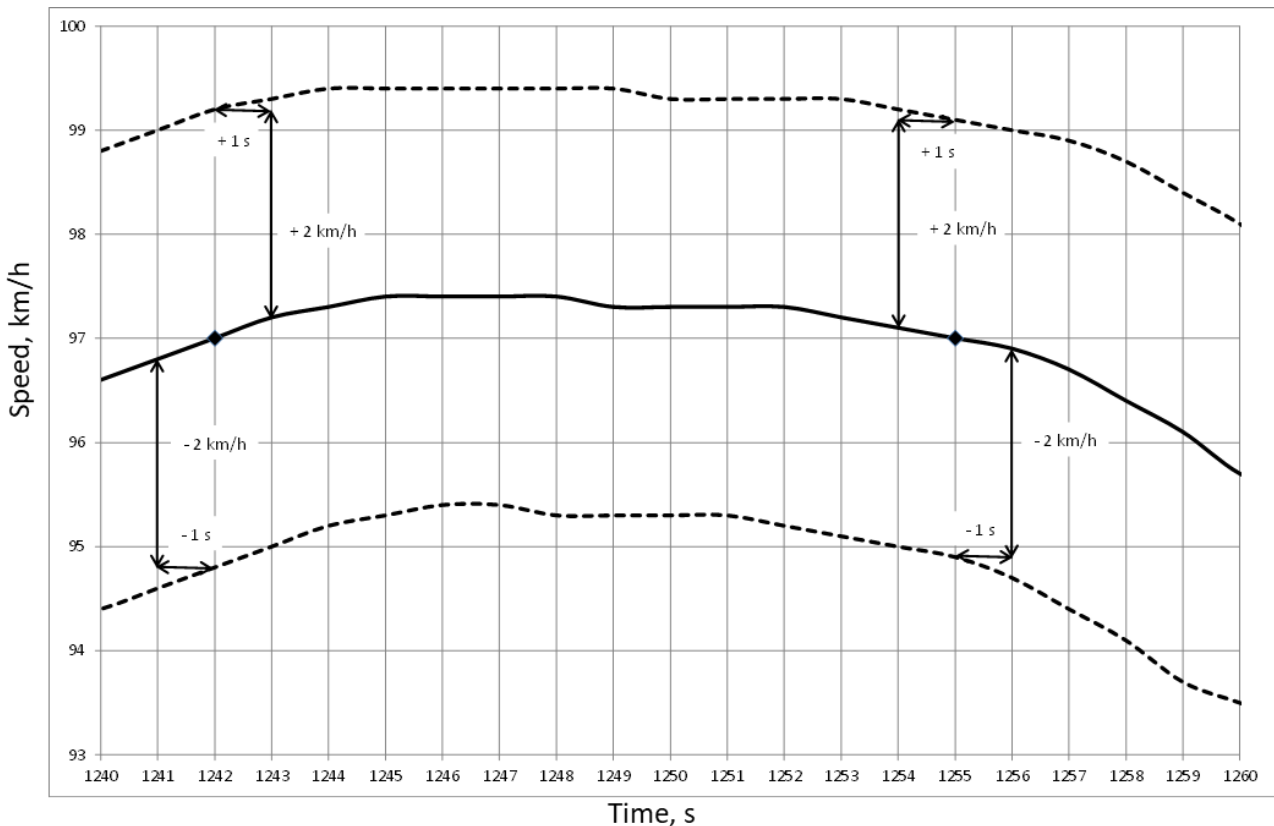
2.6.8.3.2. The vehicle operation events and tolerances to be permitted for these events are as follows:

Vehicle operation	Warm-up cycle for dynamometer setting	Pre-conditioning	Performance parameter measurement test after preconditioning
Annex B6 and B8; Type 1 Tests	Tolerance (1)	Tolerance (2)	Tolerance (2)* and Tolerance (3)
Annex C3: Type 4 Test	Tolerance (1)	Tolerance (2)	Tolerance (2)*
Annex C5 Appendix 1; OBD Demonstration Tests	Tolerance (1)	Tolerance (2)	Tolerance (2)*
COP Tests	Tolerance (1)	Tolerance (2)	Tolerance (2)* and Tolerance (4)
Derive run-in factor for COP	Tolerance (1)	Tolerance (2)	Tolerance (2)* and Tolerance (3)

*) the tolerance shall not be shown to the driver

If the speed trace is outside the respective validity range for any of the tests, those individual tests shall be considered invalid.

Figure A6/6
Speed trace tolerances



- 2.7. Soaking
 - 2.7.1. After preconditioning and before testing, the test vehicle shall be kept in an area with ambient conditions as specified in paragraph 2.2.2.2. of this annex.
 - 2.7.2. The vehicle shall be soaked for a minimum of 6 hours and a maximum of 36 hours with the engine compartment cover opened or closed. If not excluded by specific provisions for a particular vehicle, cooling may be accomplished by forced cooling down to the set point temperature. If cooling is accelerated by fans, the fans shall be placed so that the maximum cooling of the drive train, engine and exhaust after-treatment system is achieved in a homogeneous manner.
- 2.8. Emission and fuel consumption test (Type 1 test)
 - 2.8.1. The test cell temperature at the start of the test shall be $23\text{ }^{\circ}\text{C} \pm 3\text{ }^{\circ}\text{C}$. The engine oil temperature and coolant temperature, if any, shall be within $\pm 2\text{ }^{\circ}\text{C}$ of the set point of $23\text{ }^{\circ}\text{C}$.
 - 2.8.2. The test vehicle shall be pushed onto a dynamometer.
 - 2.8.2.1. The drive wheels of the vehicle shall be placed on the dynamometer without starting the engine.
 - 2.8.2.2. The drive-wheel tyre pressures shall be set in accordance with the provisions of paragraph 2.4.5. of this annex.
 - 2.8.2.3. The engine compartment cover shall be closed.
 - 2.8.2.4. An exhaust connecting tube shall be attached to the vehicle tailpipe(s) immediately before starting the engine.

- 2.8.2.5. The tested vehicle shall be placed on the chassis dynamometer according to paragraphs 7.3.3. to 7.3.3.1.4. of Annex B4.
- 2.8.3. Starting of the powertrain and driving
- 2.8.3.1. The powertrain start procedure shall be initiated by means of the devices provided for this purpose according to the manufacturer's instructions.
- 2.8.3.2. The vehicle shall be driven as described in paragraphs 2.6.4. to 2.6.8. inclusive of this annex over the applicable WLTC, as described in Annex B1.
- 2.8.4. RCB data shall be measured for each phase of the WLTC as defined in Appendix 2 to this annex.
- 2.8.5. Actual vehicle speed shall be sampled with a measurement frequency of 10 Hz and the drive trace indices described in paragraph 7. of Annex B7 shall be calculated and reported.
- 2.9. Gaseous sampling
- Gaseous samples shall be collected in bags and the compounds analysed at the end of the test or a test phase, or the compounds may be analysed continuously and integrated over the cycle.
- 2.9.1. The following steps shall be taken prior to each test:
- 2.9.1.1. The purged, evacuated sample bags shall be connected to the dilute exhaust and dilution air sample collection systems.
- 2.9.1.2. Measuring instruments shall be started according to the instrument manufacturer's instructions.
- 2.9.1.3. The CVS heat exchanger (if installed) shall be pre-heated or pre-cooled to within its operating test temperature tolerance as specified in paragraph 3.3.5.1. of Annex B5.
- 2.9.1.4. Components such as sample lines, filters, chillers and pumps shall be heated or cooled as required until stabilised operating temperatures are reached.
- 2.9.1.5. CVS flow rates shall be set according to paragraph 3.3.4. of Annex B5, and sample flow rates shall be set to the appropriate levels.
- 2.9.1.6. Any electronic integrating device shall be zeroed and may be re-zeroed before the start of any cycle phase.
- 2.9.1.7. For all continuous gas analysers, the appropriate ranges shall be selected. These may be switched during a test only if switching is performed by changing the calibration over which the digital resolution of the instrument is applied. The gains of an analyser's analogue operational amplifiers may not be switched during a test.
- 2.9.1.8. All continuous gas analysers shall be zeroed and calibrated using gases fulfilling the requirements of paragraph 6. of Annex B5.
- 2.10. Sampling for PM determination
- 2.10.1. The steps described in paragraphs 2.10.1.1. to 2.10.1.2.2. inclusive of this annex shall be taken prior to each test.
- 2.10.1.1. Filter selection
- A single particulate sample filter without back-up shall be employed for the complete applicable WLTC. In order to accommodate regional cycle variations, a single filter may be employed for the first three phases and a separate filter for the fourth phase.

- 2.10.1.2. Filter preparation
- 2.10.1.2.1. At least 1 hour before the test, the filter shall be placed in a petri dish protecting against dust contamination and allowing air exchange, and placed in a weighing chamber (or room) for stabilization.
- At the end of the stabilization period, the filter shall be weighed and its weight shall be recorded. The filter shall subsequently be stored in a closed petri dish or sealed filter holder until needed for testing. The filter shall be used within 8 hours of its removal from the weighing chamber (or room).
- The filter shall be returned to the stabilization room within 1 hour after the test and shall be conditioned for at least 1 hour before weighing.
- 2.10.1.2.2. The particulate sample filter shall be carefully installed into the filter holder. The filter shall be handled only with forceps or tongs. Rough or abrasive filter handling will result in erroneous weight determination. The filter holder assembly shall be placed in a sample line through which there is no flow.
- 2.10.1.2.3. It is recommended that the microbalance be checked at the start of each weighing session, within 24 hours of the sample weighing, by weighing one reference item of approximately 100 mg. This item shall be weighed three times and the arithmetic average result recorded. If the arithmetic average result of the weighings is $\pm 5 \mu\text{g}$ of the result from the previous weighing session, the weighing session and balance are considered valid.
- 2.11. PN sampling (if PN measurement is required)
- 2.11.1. The steps described in paragraphs 2.11.1.1. to 2.11.1.2. inclusive of this annex shall be taken prior to each test:
- 2.11.1.1. The particle specific dilution system and measurement equipment shall be started and made ready for sampling;
- 2.11.1.2. The correct function of the PNC and VPR elements of the particle sampling system shall be confirmed according to the procedures listed in paragraphs 2.11.1.2.1. to 2.11.1.2.4. inclusive of this annex.
- 2.11.1.2.1. A leak check, using a filter of appropriate performance attached to the inlet of the entire PN measurement system, VPR and PNC, shall report a measured concentration of less than 0.5 particles per cm^3 .
- 2.11.1.2.2. Each day, a zero check on the PNC, using a filter of appropriate performance at the PNC inlet, shall report a concentration of ≤ 0.2 particles per cm^3 . Upon removal of the filter, the PNC shall show an increase in measured concentration to at least 100 particles per cm^3 when sampling ambient air and a return to ≤ 0.2 particles per cm^3 on replacement of the filter.
- 2.11.1.2.3. It shall be confirmed that the measurement system indicates that the evaporation tube, where featured in the system, has reached its correct operating temperature.
- 2.11.1.2.4. It shall be confirmed that the measurement system indicates that the diluter PND_1 has reached its correct operating temperature.
- 2.12. Sampling during the test
- 2.12.1. The dilution system, sample pumps and data collection system shall be started.
- 2.12.2. The PM and, if PN measurement is required, PN sampling systems shall be started.
- 2.12.3. Particle number, if PN measurement is required, shall be measured continuously. The arithmetic average concentration shall be determined by integrating the analyser signals over each phase.
- 2.12.4. Sampling shall begin before or at the initiation of the powertrain start procedure and end on conclusion of the cycle.

- 2.12.5. Sample switching
- 2.12.5.1. Gaseous emissions
- Sampling from the diluted exhaust and dilution air shall be switched from one pair of sample bags to subsequent bag pairs, if necessary, at the end of each phase of the applicable WLTC to be driven.
- 2.12.5.2. Particulate
- The requirements of paragraph 2.10.1.1. of this annex shall apply.
- 2.12.6. Dynamometer distance shall be recorded for each phase.
- 2.13. Ending the test
- 2.13.1. The engine shall be turned off immediately after the end of the last part of the test.
- 2.13.2. The constant volume sampler, CVS, or other suction device shall be turned off, or the exhaust tube from the tailpipe or tailpipes of the vehicle shall be disconnected.
- 2.13.3. The vehicle may be removed from the dynamometer.
- 2.14. Post-test procedures
- 2.14.1. Gas analyser check
- Zero and calibration gas reading of the analysers used for continuous diluted measurement shall be checked. The test shall be considered acceptable if the difference between the pre-test and post-test results is less than 2 per cent of the calibration gas value.
- 2.14.2. Bag analysis
- 2.14.2.1. Exhaust gases and dilution air contained in the bags shall be analysed as soon as possible. Exhaust gases shall, in any event, be analysed not later than 30 minutes after the end of the cycle phase.
- The gas reactivity time for compounds in the bag shall be taken into consideration.
- 2.14.2.2. As soon as practical prior to analysis, the analyser range to be used for each compound shall be set to zero with the appropriate zero gas.
- 2.14.2.3. The calibration curves of the analysers shall be set by means of calibration gases of nominal concentrations of 70 to 100 per cent of the range.
- 2.14.2.4. The zero settings of the analysers shall be subsequently rechecked: if any reading differs by more than 2 per cent of the range from that set in paragraph 2.14.2.2. of this annex, the procedure shall be repeated for that analyser.
- 2.14.2.5. The samples shall be subsequently analysed.
- 2.14.2.6. After the analysis, zero and calibration points shall be rechecked using the same gases. The test shall be considered acceptable if the difference is less than 2 per cent of the calibration gas value.
- 2.14.2.7. The flow rates and pressures of the various gases through analysers shall be the same as those used during calibration of the analysers.
- 2.14.2.8. The content of each of the compounds measured shall be recorded after stabilization of the measuring device.
- 2.14.2.9. The mass and number of all emissions, where applicable, shall be calculated according to Annex B7.
- 2.14.2.10. Calibrations and checks shall be performed either:
- (a) Before and after each bag pair analysis; or

(b) Before and after the complete test.

In case (b), calibrations and checks shall be performed on all analysers for all ranges used during the test.

In both cases, (a) and (b), the same analyser range shall be used for the corresponding ambient air and exhaust bags.

2.14.3. Particulate sample filter weighing

2.14.3.1. The particulate sample filter shall be returned to the weighing chamber (or room) no later than 1 hour after completion of the test. It shall be conditioned in a petri dish, which is protected against dust contamination and allows air exchange, for at least 1 hour, and weighed. The gross weight of the filter shall be recorded.

2.14.3.2. At least two unused reference filters shall be weighed within 8 hours of, but preferably at the same time as, the sample filter weighings. Reference filters shall be of the same size and material as the sample filter.

2.14.3.3. If the specific weight of any reference filter changes by more than $\pm 5 \mu\text{g}$ between sample filter weighings, the sample filter and reference filters shall be reconditioned in the weighing chamber (or room) and reweighed.

2.14.3.4. The comparison of reference filter weighings shall be made between the specific weights and the rolling arithmetic average of that reference filter's specific weights. The rolling arithmetic average shall be calculated from the specific weights collected in the period after the reference filters were placed in the weighing chamber (or room). The averaging period shall be at least one day but not more than 15 days.

2.14.3.5. Multiple reconditionings and reweighings of the sample and reference filters are permitted until a period of 80 hours has elapsed following the measurement of gases from the emissions test. If, prior to or at the 80-hour point, more than half the number of reference filters meet the $\pm 5 \mu\text{g}$ criterion, the sample filter weighing may be considered valid. If, at the 80-hour point, two reference filters are employed and one filter fails the $\pm 5 \mu\text{g}$ criterion, the sample filter weighing may be considered valid under the condition that the sum of the absolute differences between specific and rolling means from the two reference filters shall be less than or equal to $10 \mu\text{g}$.

2.14.3.6. In the case that less than half of the reference filters meet the $\pm 5 \mu\text{g}$ criterion, the sample filter shall be discarded, and the emissions test repeated. All reference filters shall be discarded and replaced within 48 hours. In all other cases, reference filters shall be replaced at least every 30 days and in such a manner that no sample filter is weighed without comparison to a reference filter that has been present in the weighing chamber (or room) for at least one day.

2.14.3.7. If the weighing chamber (or room) stability criteria outlined in paragraph 4.2.2.1. of Annex B5 are not met, but the reference filter weighings meet the above criteria, the vehicle manufacturer has the option of accepting the sample filter weights or voiding the tests, repairing the weighing chamber (or room) control system and re-running the test.

Annex B6 - Appendix 1

Emissions test procedure for all vehicles equipped with periodically regenerating systems

1. General
 - 1.1. This appendix defines the specific provisions regarding testing a vehicle equipped with periodically regenerating systems as defined in paragraph 3.8.1. of this Regulation.
 - 1.2. During cycles where regeneration occurs, emission standards need not apply. If a periodic regeneration occurs at least once per Type 1 test and has already occurred at least once during vehicle preparation or the distance between two successive periodic regenerations is more than 4,000 km of driving repeated Type 1 tests, it does not require a special test procedure. In this case, this appendix does not apply and a K_i factor of 1.0 shall be used.
 - 1.3. The provisions of this appendix shall not apply to PN emissions.
 - 1.4. At the request of the manufacturer, and with approval of the responsible authority, the test procedure specific to periodically regenerating systems need not apply to a regenerative device if the manufacturer provides data demonstrating that, during cycles where regeneration occurs, emissions remain below the emissions limits specified in paragraph 6.3.10. of this Regulation for the relevant vehicle category. In this case, a fixed K_i value of 1.05 shall be used for CO₂ and fuel consumption.
2. Test procedure

The test vehicle shall be capable of inhibiting or permitting the regeneration process provided that this operation has no effect on original engine calibrations. Prevention of regeneration is only permitted during loading of the regeneration system and during the preconditioning cycles. It is not permitted during the measurement of emissions during the regeneration phase. The emission test shall be carried out with the unchanged, original equipment manufacturer's (OEM) control unit. At the request of the manufacturer and with agreement of the responsible authority, an "engineering control unit" which has no effect on original engine calibrations may be used during K_i determination.

 - 2.1. Exhaust emissions measurement between two WLTCs with regeneration events
 - 2.1.1. The arithmetic average emissions between regeneration events and during loading of the regenerative device shall be determined from the arithmetic mean of several approximately equidistant (if more than two) Type 1 tests. As an alternative, the manufacturer may provide data to show that the emissions remain constant (± 15 per cent) on WLTCs between regeneration events. In this case, the emissions measured during the Type 1 test may be used. In any other case, emissions measurements for at least two Type 1 cycles shall be completed: one immediately after regeneration (before new loading) and one as close as possible prior to a regeneration phase. All emissions measurements shall be carried out according to this annex and all calculations shall be carried out according to paragraph 3. of this appendix.
 - 2.1.2. The loading process and K_i determination shall be made during the Type 1 driving cycle on a chassis dynamometer or on an engine test bench using an equivalent test cycle. These cycles may be run continuously (i.e. without the need to switch the engine off between cycles). After any number of completed cycles, the vehicle may be removed from the chassis dynamometer and the test continued at a later time.

For Class 2 and Class 3 vehicles, at the request of the manufacturer and with the agreement of the responsible authority the K_i can be determined either with or without the Extra High phase.

Upon request of the manufacturer and with approval of the responsible authority, a manufacturer may develop an alternative procedure and demonstrate its equivalency, including filter temperature, loading quantity and distance driven. This may be done on an engine bench or on a chassis dynamometer.

2.1.3. The number of cycles D between two WLTCs where regeneration events occur, the number of cycles over which emission measurements are made n and the mass emissions measurement M'_{sij} for each compound i over each cycle j shall be recorded.

2.2. Measurement of emissions during regeneration events

2.2.1. Preparation of the vehicle, if required, for the emissions test during a regeneration phase, may be completed using the preconditioning cycles in paragraph 2.6. of this annex or equivalent engine test bench cycles, depending on the loading procedure chosen in paragraph 2.1.2. of this appendix.

2.2.2. The test and vehicle conditions for the Type 1 test described in this Regulation apply before the first valid emission test is carried out.

2.2.3. Regeneration shall not occur during the preparation of the vehicle. This may be ensured by one of the following methods:

(a) A "dummy" regenerating system or partial system may be fitted for the preconditioning cycles;

(b) Any other method agreed between the manufacturer and the responsible authority.

2.2.4. A cold start exhaust emissions test including a regeneration process shall be performed according to the applicable WLTC.

2.2.5. If the regeneration process requires more than one WLTC, each WLTC shall be completed. Use of a single particulate sample filter for multiple cycles required to complete regeneration is permissible.

If more than one WLTC is required, subsequent WLTC(s) shall be driven immediately, without switching the engine off, until complete regeneration has been achieved. In the case that the number of gaseous emission bags required for the multiple cycles would exceed the number of bags available, the time necessary to set up a new test shall be as short as possible. The engine shall not be switched off during this period.

2.2.6. The emission values during regeneration M_{ri} for each compound i shall be calculated according to paragraph 3. of this appendix. The number of applicable test cycles d measured for complete regeneration shall be recorded.

3. Calculations

3.1. Calculation of the exhaust and CO₂ emissions, and fuel consumption of a single regenerative system

$$M_{si} = \frac{\sum_{j=1}^n M'_{sij}}{n} \text{ for } n \geq 1$$

$$M_{ri} = \frac{\sum_{j=1}^d M'_{rij}}{d} \text{ for } d \geq 1$$

$$M_{pi} = \frac{M_{si} \times D + M_{ri} \times d}{D + d}$$

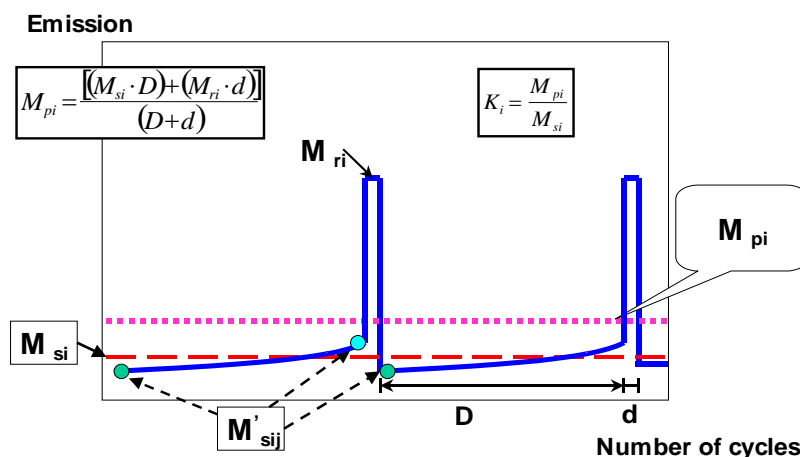
where for each compound i considered:

- M'_{sij} are the mass emissions of compound i over test cycle j without regeneration, g/km;
- M'_{rij} are the mass emissions of compound i over test cycle j during regeneration, g/km (if $d > 1$, the first WLTC test shall be run cold and subsequent cycles hot);
- M_{si} are the mean mass emissions of compound i without regeneration, g/km;
- M_{ri} are the mean mass emissions of compound i during regeneration, g/km;
- M_{pi} are the mean mass emissions of compound i , g/km;
- n is the number of test cycles, between cycles where regenerative events occur, during which emissions measurements on Type 1 WLTCs are made, ≥ 1 ;
- d is the number of complete applicable test cycles required for regeneration;
- D is the number of complete applicable test cycles between two cycles where regeneration events occur.

The calculation of M_{pi} is shown graphically in Figure A6.App1/1.

Figure A6.App1/1

Parameters measured during emissions test during and between cycles where regeneration occurs (schematic example, the emissions during D may increase or decrease)



3.1.1. Calculation of the regeneration factor K_i for each compound i considered

The manufacturer may elect to determine for each compound independently either additive offsets or multiplicative factors.

K_i factor: $K_i = \frac{M_{pi}}{M_{si}}$

K_i offset: $K_i = M_{pi} - M_{si}$

M_{si} , M_{pi} and K_i results, and the manufacturer's choice of type of factor shall be recorded. The K_i result shall be included in all relevant test reports. M_{si} , M_{pi} and K_i results shall be included in all relevant test sheets.

K_i may be determined following the completion of a single regeneration sequence comprising measurements before, during and after regeneration events as shown in Figure A6.App1/1.

3.2. Calculation of exhaust and CO₂ emissions, and fuel consumption of multiple periodically regenerating systems

The following shall be calculated for one Type 1 operation cycle for criteria emissions and for CO₂ emissions. The CO₂ emissions used for that calculation shall be from the result of step 3 described in Table A7/1 of Annex B7.

$$M_{sik} = \frac{\sum_{j=1}^{n_k} M'_{sik,j}}{n_k} \text{ for } n_j \geq 1$$

$$M_{rik} = \frac{\sum_{j=1}^{d_k} M'_{rik,j}}{d_k} \text{ for } d \geq 1$$

$$M_{si} = \frac{\sum_{k=1}^x M_{sik} \times D_k}{\sum_{k=1}^x D_k}$$

$$M_{ri} = \frac{\sum_{k=1}^x M_{rik} \times d_k}{\sum_{k=1}^x d_k}$$

$$M_{pi} = \frac{M_{si} \times \sum_{k=1}^x D_k + M_{ri} \times \sum_{k=1}^x d_k}{\sum_{k=1}^x (D_k + d_k)}$$

$$M_{pi} = \frac{\sum_{k=1}^x (M_{sik} \times D_k + M_{rik} \times d_k)}{\sum_{k=1}^x (D_k + d_k)}$$

$$K_i \text{ factor: } K_i = \frac{M_{pi}}{M_{si}}$$

$$K_i \text{ offset: } K_i = M_{pi} - M_{si}$$

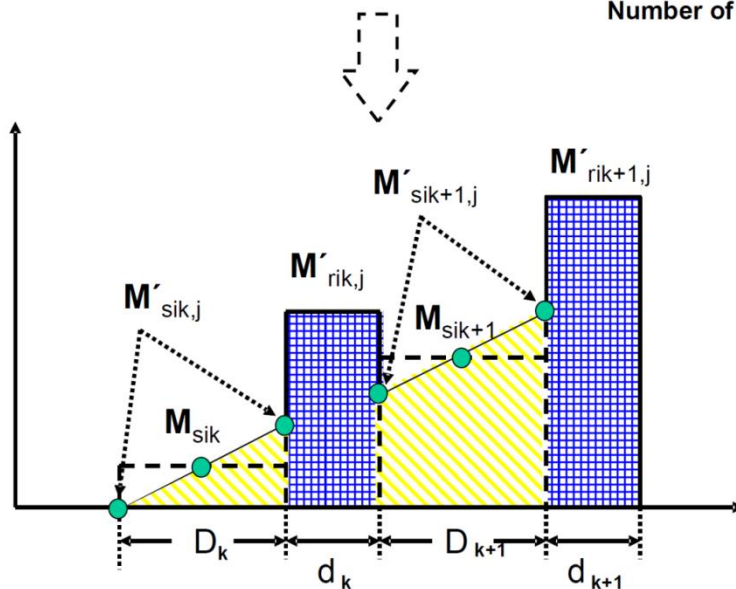
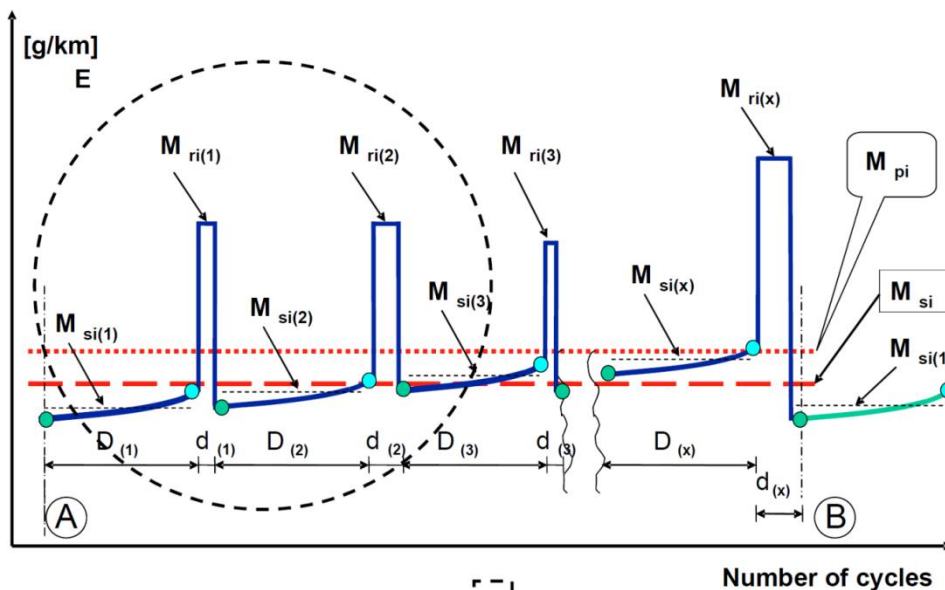
where:

- M_{si} are the mean mass emissions of all events k of compound i without regeneration, g/km;
- M_{ri} are the mean mass emissions of all events k of compound i during regeneration, g/km;
- M_{pi} are the mean mass emission of all events k of compound i , g/km;
- M_{sik} are the mean mass emissions of event k of compound i without regeneration, g/km;
- M_{rik} are the mean mass emissions of event k of compound i during regeneration, g/km;
- $M'_{sik,j}$ are the mass emissions of event k of compound i in g/km without regeneration measured at point j where $1 \leq j \leq n_k$, g/km;
- $M'_{rik,j}$ are the mass emissions of event k of compound i during regeneration (when $j > 1$, the first Type 1 test is run cold, and subsequent cycles are hot) measured at test cycle j where $1 \leq j \leq d_k$, g/km;
- n_k are the number of complete test cycles of event k , between two cycles where regenerative phases occur, during which emissions measurements (Type 1 WLTCs or equivalent engine test bench cycles) are made, ≥ 2 ;
- d_k is the number of complete applicable test cycles of event k required for complete regeneration;
- D_k is the number of complete applicable test cycles of event k between two cycles where regenerative phases occur;
- x is the number of complete regeneration events.

The calculation of M_{pi} is shown graphically in Figure A6.App1/2.

Figure A6.App1/2

Parameters measured during emissions test during and between cycles where regeneration occurs (schematic example)



The calculation of K_i for multiple periodically regenerating systems is only possible after a certain number of regeneration events for each system.

After performing the complete procedure (A to B, see Figure A6.App1/2), the original starting condition A should be reached again.

- 3.3. K_i factors and K_i offsets shall be rounded to four places of decimal. For K_i offsets, the rounding shall be based on the physical unit of the emission standard value.

Annex B6 - Appendix 2

Test procedure for rechargeable electric energy storage system monitoring

1. General

In the case that NOVC-HEVs, OVC-HEVs and NOVC-FCHVs] are tested, Appendices 2 and 3 to Annex B8 shall apply.

This appendix defines the specific provisions regarding the correction of test results for CO₂ mass emission as a function of the energy balance ΔE_{REESS} for all REESSs.

The corrected values for CO₂ mass emission shall correspond to a zero energy balance ($\Delta E_{REESS} = 0$), and shall be calculated using a correction coefficient determined as defined below.

2. Measurement equipment and instrumentation

2.1. Current measurement

REESS depletion shall be defined as negative current.

2.1.1. The REESS current(s) shall be measured during the tests using a clamp-on or closed type current transducer. The current measurement system shall fulfil the requirements specified in Table A8/1. The current transducer(s) shall be capable of handling the peak currents at engine starts and temperature conditions at the point of measurement.

In order to have an accurate measurement, zero adjustment and degaussing shall be performed before the test according to the instrument manufacturer's instructions.

2.1.2. Current transducers shall be fitted to any of the REESS on one of the cables connected directly to the REESS and shall include the total REESS current.

In case of shielded wires, appropriate methods shall be applied in accordance with the responsible authority.

In order to easily measure REESS current using external measuring equipment, manufacturers should preferably integrate appropriate, safe and accessible connection points in the vehicle. If this is not feasible, the manufacturer shall support the responsible authority by providing the means to connect a current transducer to the REESS cables in the manner described above.

2.1.3. The measured current shall be integrated over time at a minimum frequency of 20 Hz, yielding the measured value of Q, expressed in ampere-hours Ah. The measured current shall be integrated over time, yielding the measured value of Q, expressed in ampere-hours Ah. The integration may be done in the current measurement system.

2.2. Vehicle on-board data

2.2.1. Alternatively, the REESS current shall be determined using vehicle-based data. In order to use this measurement method, the following information shall be accessible from the test vehicle:

- (a) Integrated charging balance value since last ignition run in Ah;
- (b) Integrated on-board data charging balance value calculated at a minimum sample frequency of 5 Hz;
- (c) The charging balance value via an OBD connector as described in SAE J1962.

- 2.2.2. The accuracy of the vehicle on-board REESS charging and discharging data shall be demonstrated by the manufacturer to the responsible authority.

The manufacturer may create a REESS monitoring vehicle family to prove that the vehicle on-board REESS charging and discharging data are correct. The accuracy of the data shall be demonstrated on a representative vehicle.

The following family criteria shall be valid:

- (a) Identical combustion processes (i.e. positive ignition, compression ignition, two-stroke, four-stroke);
 - (b) Identical charge and/or recuperation strategy (software REESS data module);
 - (c) On-board data availability;
 - (d) Identical charging balance measured by REESS data module;
 - (e) Identical on-board charging balance simulation.
- 2.2.3. All REESS having no influence on CO₂ mass emissions shall be excluded from monitoring.

3. REESS energy change-based correction procedure

- 3.1. Measurement of the REESS current shall start at the same time as the test starts and shall end immediately after the vehicle has driven the complete driving cycle.
- 3.2. The electricity balance Q measured in the electric power supply system shall be used as a measure of the difference in the REESS energy content at the end of the cycle compared to the beginning of the cycle. The electricity balance shall be determined for the total driven WLTC.
- 3.3. Separate values of Q_{phase} shall be logged over the driven cycle phases.
- 3.4. Correction of CO₂ mass emission over the whole cycle as a function of the correction criterion c
- 3.4.1. Calculation of the correction criterion c

The correction criterion c is the ratio between the absolute value of the electric energy change $\Delta E_{\text{REESS},j}$ and the fuel energy and shall be calculated using the following equations:

$$c = \left| \frac{\Delta E_{\text{REESS},j}}{E_{\text{fuel}}} \right|$$

where:

- c is the correction criterion;
- $\Delta E_{\text{REESS},j}$ is the electric energy change of all REESSs over period j determined according to paragraph 4.1. of this appendix, Wh;
- j is, in this paragraph, the whole applicable WLTP test cycle;
- E_{fuel} is the fuel energy according to the following equation:

$$E_{\text{fuel}} = 10 \times \text{HV} \times \text{FC}_{\text{nb}} \times d$$

where:

- E_{fuel} is the energy content of the consumed fuel over the applicable WLTP test cycle, Wh;
- HV is the heating value according to Table A6.App2/1, kWh/l;
- FC_{nb} is the non-balanced fuel consumption of the Type 1 test, not corrected for the energy balance, determined according to

paragraph 6. of Annex B7, and using the results for criteria emissions and CO₂ calculated in step 2 in Table A7/1, 1/100 km;

d is the distance driven over the corresponding applicable WLTP test cycle, km;

10 conversion factor to Wh.

3.4.2. The correction shall be applied if ΔE_{REESS} is negative (corresponding to REESS discharging)

At the request of the manufacturer, the correction may be omitted and uncorrected values may be used if:

- (a) ΔE_{REESS} is positive (corresponding to REESS charging);
- (b) the manufacturer can prove to the responsible authority by measurement that there is no relation between ΔE_{REESS} and CO₂ mass emission and ΔE_{REESS} and fuel consumption respectively.

Table A6.App2/1

Energy content of fuel (as applicable)

Fuel	Petrol (E0)	Petrol (E10)	Ethanol (E85)	Diesel (B0)	Diesel (B7)	LPG	CNG
Heat value	8.92 kWh/l	8.64 kWh/l	6.41 kWh/l	9.85 kWh/l	9.79 kWh/l	12.86 x ρ kWh/l	11.39 MJ/m ³

ρ = test fuel density at 15°C (kg/l)

4. Applying the correction function

4.1. To apply the correction function, the electric energy change $\Delta E_{REESS,j}$ of a period j of all REESSs shall be calculated from the measured current and the nominal voltage:

$$\Delta E_{REESS,j} = \sum_{i=1}^n \Delta E_{REESS,j,i}$$

where:

$\Delta E_{REESS,j,i}$ is the electric energy change of REESS i during the considered period j, Wh;

and:

$$\Delta E_{REESS,j,i} = \frac{1}{3600} \times U_{REESS} \times \int_{t_0}^{t_{end}} I(t)_{j,i} dt$$

where:

U_{REESS} is the nominal REESS voltage determined according to IEC 60050-482, V;

$I(t)_{j,i}$ is the electric current of REESS i during the considered period j, determined according to paragraph 2. of this appendix, A;

t_0 is the time at the beginning of the considered period j, s;

t_{end} is the time at the end of the considered period j, s.

i is the index number of the considered REESS;

n is the total amount of REESS;

j is the index number for the considered period, where a period shall be any applicable cycle phase, combination of cycle phases and the applicable total cycle;

$\frac{1}{3600}$ is the conversion factor from Ws to Wh.

- 4.2. For correction of CO₂ mass emission, g/km, combustion process-specific Willans factors from Table A6.App2/3 shall be used.
- 4.3. The correction shall be performed and applied for the total cycle and for each of its cycle phases separately, and shall be recorded.
- 4.4. For this specific calculation, a fixed electric power supply system alternator efficiency shall be used:

$$\eta_{\text{alternator}} = 0.67 \text{ for electric power supply system REESS alternators}$$

- 4.5. The resulting CO₂ mass emission difference for the considered period j due to load behaviour of the alternator for charging a REESS shall be calculated using the following equation:

$$\Delta M_{\text{CO}_2,j} = 0.0036 \times \Delta E_{\text{REESS},j} \times \frac{1}{\eta_{\text{alternator}}} \times \text{Willans}_{\text{factor}} \times \frac{1}{d_j}$$

where:

- $\Delta M_{\text{CO}_2,j}$ is the resulting CO₂ mass emission difference of period j, g/km;
- $\Delta E_{\text{REESS},j}$ is the REESS energy change of the considered period j calculated according to paragraph 4.1. of this appendix, Wh;
- d_j is the driven distance of the considered period j, km;
- j is the index number for the considered period, where a period shall be any applicable cycle phase, combination of cycle phases and the applicable total cycle;
- 0.0036 is the conversion factor from Wh to MJ;
- $\eta_{\text{alternator}}$ is the efficiency of the alternator according to paragraph 4.4. of this appendix;
- $\text{Willans}_{\text{factor}}$ is the combustion process-specific Willans factor as defined in Table A6.App2/3, gCO₂/MJ;

- 4.5.1. The CO₂ values of each phase and the total cycle shall be corrected as follows:

$$M_{\text{CO}_2,p,3} = (M_{\text{CO}_2,p,1} - \Delta M_{\text{CO}_2,j})$$

$$M_{\text{CO}_2,c,3} = (M_{\text{CO}_2,c,2} - \Delta M_{\text{CO}_2,j})$$

where:

$\Delta M_{\text{CO}_2,j}$ is the result from paragraph 4.5. of this appendix for a period j, g/km.

- 4.6. For the correction of CO₂ emission, g/km, the Willans factors in Table A6.App2/3 shall be used.

Table A6.App2/3

Willans factors (as applicable)

			<i>Naturally aspirated</i>	<i>Pressure-charged</i>
Positive ignition	Petrol (E0)	l/MJ	0.0733	0.0778
		gCO ₂ /MJ	175	186
	Petrol (E10)	l/MJ	0.0756	0.0803
		gCO ₂ /MJ	174	184
	CNG (G20)	m ³ /MJ	0.0719	0.0764
		gCO ₂ /MJ	129	137
	LPG	l/MJ	0.0950	0.101
		gCO ₂ /MJ	155	164
	E85	l/MJ	0.102	0.108
		gCO ₂ /MJ	169	179
Compression ignition	Diesel (B0)	l/MJ	0.0611	0.0611
		gCO ₂ /MJ	161	161
	Diesel (B7)	l/MJ	0.0611	0.0611
		gCO ₂ /MJ	161	161

Annex B6 - Appendix 3

Calculation of gas energy ratio for gaseous fuels (LPG and NG/biomethane)

1. Measurement of the mass of gaseous fuel consumed during the Type 1 test cycle

Measurement of the mass of gas consumed during the cycle shall be done by a fuel weighing system capable of measuring the weight of the storage container during the test in accordance with the following:

- (a) An accuracy of ± 2 per cent of the difference between the readings at the beginning and at the end of the test or better.
- (b) Precautions shall be taken to avoid measurement errors.
Such precautions shall at least include the careful installation of the device according to the instrument manufacturer's recommendations and to good engineering practice.
- (c) Other measurement methods are permitted if an equivalent accuracy can be demonstrated.

2. Calculation of the gas energy ratio

The fuel consumption value shall be calculated from the emissions of hydrocarbons, carbon monoxide, and carbon dioxide determined from the measurement results assuming that only the gaseous fuel is burned during the test.

The gas ratio of the energy consumed in the cycle shall be determined using the following equation:

$$G_{\text{gas}} = \left(\frac{M_{\text{gas}} \times \text{cf} \times 10^4}{\text{FC}_{\text{norm}} \times \text{dist} \times \rho} \right)$$

where:

- | | |
|---------------------------|--|
| G_{gas} | is the gas energy ratio, per cent; |
| M_{gas} | is the mass of the gaseous fuel consumed during the cycle, kg; |
| FC_{norm} | is the fuel consumption (l/100km for LPG, $\text{m}^3/100 \text{ km}$ for NG/biomethane) calculated in accordance with paragraphs 6.6. and 6.7. of Annex B7; |
| dist | is the distance recorded during the cycle, km; |
| ρ | is the gas density:
$\rho = 0.654 \text{ kg/m}^3$ for NG/Biomethane;
$\rho = 0.538 \text{ kg/litre}$ for LPG; |
| cf | is the correction factor, assuming the following values:
cf = 1 in the case of LPG or G20 reference fuel;
cf = 0.78 in the case of G25 reference fuel. |

Annex B6a

This annex is only applicable for the CO₂ emissions from the 4 phases of a WLTP test;

Ambient Temperature Correction Test for the determination of CO₂ emissions under representative regional temperature conditions

1. Introduction

This annex describes the supplemental Ambient Temperature Correction Test (ATCT) procedure to determine the CO₂ emissions under representative regional temperature conditions.

- 1.1. The CO₂ emissions of ICE vehicles, NOVC-HEVs and the charge sustaining value of OVC-HEVs shall be corrected in accordance with the requirements of this annex. No correction is required for the CO₂ value of the charge depleting test. No correction is required for an Electric Range.

2. Ambient Temperature Correction Test (ATCT) Family

- 2.1. Only vehicles which are identical with respect to all the following characteristics are permitted to be part of the same ATCT Family:

- (a) Powertrain architecture (i.e. internal combustion, hybrid, fuel cell, or electric);
- (b) Combustion process (i.e. two stroke or four stroke);
- (c) Number and arrangement of cylinders;
- (d) Method of engine combustion (i.e. indirect or direct injection);
- (e) Type of cooling system (i.e. air, water, or oil);
- (f) Method of aspiration (i.e. naturally aspirated, or charged);
- (g) Fuel for which the engine is designed (i.e. petrol, diesel, NG, LPG, etc.);
- (h) Catalytic converter (i.e. three-way catalyst, lean NO_x trap, SCR, lean NO_x catalyst or other(s));
- (i) Whether or not a particulate trap is installed; and
- (j) Exhaust gas recirculation (with or without, cooled or non-cooled).

In addition the vehicles shall be similar with respect to the following characteristics:

- (k) The vehicles shall have a variation in engine cylinder capacity of no more than 30 per cent of the vehicle with the lowest capacity; and
- (l) Engine compartment insulation shall be of a similar type regarding material, amount and location of the insulation. Manufacturers shall provide evidence (e.g. by CAD drawings) to the approval authority that for all vehicles in the family, the volume and weight of the insulation material which will be installed is greater than 90 per cent of that of the ATCT measured reference vehicle.

Difference in insulation material and location may also be accepted to be part of a single ATCT family under the condition that the test vehicle can be demonstrated as being the worst case with regards to engine compartment insulation.

If the manufacturer can demonstrate to the Type Approval Authority that it is ensured that the worst case concept is maintained (e.g. tested vehicle has no

insulation), or if the ATCT is composed of a single Interpolation Family, the requirements to document the insulation materials may be waived.

- 2.1.1. If active heat storage devices are installed, only vehicles that meet the following requirements shall be considered to be part of the same ATCT Family:
- (a) the heat capacity, defined by the enthalpy stored in the system, is within a range of 0 to 10 per cent above the enthalpy of the test vehicle; and
 - (b) the OEM can provide evidence to the technical service that the time for heat release at engine start within a family is within a range of 0 to 10 per cent below the time for the heat release of the test vehicle.

- 2.1.2. Only vehicles that meet the criteria set out in paragraph 3.9.4. of this Annex B6a shall be considered to be part of the same ATCT Family.

3. ATCT Procedure

The Type 1 test specified in Annex B6 shall be carried out with the exception of the requirements specified in paragraphs 3.1. to 3.9. of this Annex B6a. That requires also a new calculation and application of gearshift points in accordance with Annex B2 taking into account the different road load as specified in paragraph 3.4. of this Annex B6a.

3.1. Ambient conditions for ATCT

- 3.1.1. The temperature (T_{reg}) at which the vehicle should be soaked and tested for the ATCT shall be 14 °C.

- 3.1.2. The minimum soaking time (t_{soak_ATCT}) for the ATCT shall be 9 hours.

3.2. Test cell and soak area

3.2.1. Test cell

- 3.2.1.1. The test cell shall have a temperature set point equal to T_{reg} . The actual temperature value shall be within ± 3 °C at the start of the test and within ± 5 °C during the test.

- 3.2.1.2. The specific humidity (H) of either the air in the test cell or the intake air of the engine shall be such that:

$$3.0 \leq H \leq 8.1 \text{ (g H}_2\text{O/kg dry air)}$$

- 3.2.1.3. The air temperature and humidity shall be measured at the cooling fan outlet at a rate of 0.1 Hz.

3.2.2. Soak area

- 3.2.2.1. The soak area shall have a temperature set point equal to T_{reg} and the actual temperature value shall be within ± 3 °C on a 5 minute running arithmetic average and shall not show a systematic deviation from the set point. The temperature shall be measured continuously at a minimum frequency of 0.033 Hz.

- 3.2.2.2. The location of the temperature sensor for the soak area shall be representative to measure the ambient temperature around the vehicle and shall be checked by the technical service.

The sensor shall be at least 10 cm away from the wall of the soak area and shall be shielded from direct air flow.

The air-flow conditions within the soak room in the vicinity of the vehicle shall represent a natural convection flow representative for the dimension of the room (no forced convection).

- 3.3. Test vehicle
- 3.3.1. The vehicle to be tested shall be representative of the family for which the ATCT data are determined (as described in paragraph 2.1. of this Annex B6a).
- 3.3.2. From the ATCT Family, the Interpolation Family with the lowest engine capacity shall be selected (see paragraph 2 of this Annex B6a), and the test vehicle shall be in the 'vehicle H' configuration of this family.
- 3.3.3. Where applicable, the vehicle with the lowest enthalpy of the active heat storage device and the slowest heat release for the active heat storage device from the ATCT Family shall be selected.
- 3.3.4. The test vehicle shall meet the requirements detailed in paragraph 2.3. of Annex B6 and paragraph 2.1 of this Annex B6a.
- 3.4. Settings
- 3.4.1. Road load and dynamometer settings shall be as specified in Annex B4, including the requirement for the room temperature to be at 23 °C.
- To take account of the difference in air density at 14 °C when compared to the air density at 20 °C, the chassis dynamometer shall be set as specified in paragraphs 7. and 8. of Annex B4 with the exception that f_{2_TReg} from the following equation shall be used as the target coefficient C_i .
- $$f_{2_TReg} = f_2 * (T_{ref} + 273)/(T_{reg} + 273)$$
- where:
- f_2 is the second order road load coefficient, at reference conditions, $N/(km/h)^2$;
- T_{ref} is the road load reference temperature as specified in paragraph 3.2.10. of this Regulation, C;
- T_{reg} is the regional temperature, as defined in paragraph 3.1.1. of this Annex B6a, C.
- In the case that a valid chassis dynamometer setting of the 23 °C test is available, the second order chassis dynamometer coefficient of C_d shall be adapted in accordance with the following equation:
- $$C_{d_TReg} = C_d + (f_{2_TReg} - f_2)$$
- 3.4.2. The ATCT test and its road load setting shall be performed on a 2WD dynamometer in the case that the corresponding Type 1 test was done on a 2WD dynamometer; and it shall be performed on a 4WD dynamometer in the case that the corresponding Type 1 test was done on a 4WD dynamometer.
- 3.5. Preconditioning
- At the request of the manufacturer preconditioning may be undertaken at T_{reg} . The engine temperature shall be within ± 2 °C of the set point of 23 °C or T_{reg} , whichever temperature is chosen for the preconditioning.
- 3.5.1. Pure ICE vehicles shall be preconditioned as described in paragraph 2.6. of Annex B6.
- 3.5.2. NOVC-HEVs shall be preconditioned as described in paragraph 3.3.1.1. of Annex B8.
- 3.5.3. OVC-HEVs shall be preconditioned as described in paragraph 2.1.1. or 2.1.2. of Appendix 4 to Annex B8.
- 3.6. Soak procedure
- 3.6.1. After preconditioning and before testing, vehicles shall be kept in a soak area with the ambient conditions described in paragraph 3.2.2. of this Annex B6a.

- 3.6.2. From the end of the preconditioning until the soaking at T_{reg} , the vehicle shall not be exposed to a different temperature than T_{reg} for longer than 10 minutes.
- 3.6.3. The vehicle shall then be kept in the soak area such that the time from the end of the preconditioning test to the beginning of the ATCT test is equal to t_{soak_ATCT} with a tolerance of an additional 15 minutes. At the request of the manufacturer, and upon approval of the approval authority, t_{soak_ATCT} can be extended by up to 120 minutes. In this case, the extended time shall be used for the cool down specified in paragraph 3.9. of this Annex B6a.
- 3.6.4. The soak shall be performed without using a cooling fan and with all body parts positioned as intended under normal parking operation. The time between the end of the preconditioning and the start of the ATCT test shall be recorded.
- 3.6.5. The transfer from the soak area to the test cell shall be undertaken as quickly as possible. The vehicle shall not be exposed to a temperature different from T_{reg} for longer than 10 minutes.
- 3.7. ATCT Test
- 3.7.1. The test cycle shall be the applicable WLTC specified in Annex B1 for that class of vehicle.
- 3.7.2. The procedures for undertaking the emissions test as specified in Annex B6 for pure ICE vehicles and in Annex B8 for NOVC-HEVs and for the charge-sustaining Type 1 test of OVC-HEVs shall be followed, with the exception that the ambient conditions for the test cell shall be those as described in paragraph 3.2.1. of this Annex B6a.
- 3.7.3. In particular, the tailpipe emissions defined by Table A7/1 Step no.2 for pure ICE vehicles and Table A8/5 Step no.2 for HEVs at an ATCT test shall not exceed the emission limits applicable to the vehicle tested defined in paragraph 6.3.10. of this Regulation.
- 3.8. Calculation and Documentation
- 3.8.1. The family correction factor, FCF , shall be calculated as follows:

$$FCF = M_{CO_2, T_{reg}} / M_{CO_2, 23^\circ}$$

where

$M_{CO_2, 23^\circ}$ is the CO₂ mass emission of the average of all applicable Type 1 tests at 23 °C of vehicle H, after Step 3 of Table A7/1 of Annex B7 for pure ICE vehicles and after Step 3 of Table A8/5 of Annex B8 for OVC-HEVs and NOVC-HEVs, but without any further corrections, g/km;

$M_{CO_2, T_{reg}}$ is the CO₂ mass emission over the complete WLTC cycle of the test at regional temperature after Step 3 of Table A7/1 of Annex B7 for pure ICE vehicles and after Step 3 of Table A8/5 of Annex B8 for OVC-HEVs and NOVC-HEVs but without any further corrections, g/km. For OVC-HEVs and NOVC-HEVs, the K_{CO_2} factor as defined in Appendix 2 to Annex B8 shall be used.

Both $M_{CO_2, 23^\circ}$ and $M_{CO_2, T_{reg}}$ shall be measured on the same test vehicle.

The FCF shall be included in all relevant test reports.

The FCF shall be rounded to 4 points of decimal.

- 3.8.2. The CO₂ values for each pure ICE vehicle within the ATCT Family (as defined in paragraph 2.3. of this Annex B6a) shall be calculated using the following equations:

$$M_{CO_2, e, 5} = M_{CO_2, e, 4} \times FCF$$

$$M_{CO_2, p, 5} = M_{CO_2, p, 4} \times FCF$$

where

$M_{CO_2,c,4}$ and $M_{CO_2,p,4}$ are the CO₂ mass emissions over the complete WLTC, c, and the cycle phases, p, resulting from the previous calculation step, g/km;

$M_{CO_2,c,5}$ and $M_{CO_2,p,5}$ are the CO₂ mass emissions over the complete WLTC, c, and the cycle phases, p, including the ATCT correction, and shall be used for any further corrections or any further calculations, g/km;

- 3.8.3. The CO₂ values for each OVC-HEV and NOVC-HEV within the ATCT Family (as defined in paragraph 2.3. of this Annex B6a) shall be calculated using the following equations:

$$M_{CO_2,CS,c,5} = M_{CO_2,CS,c,4} \times FCF$$

$$M_{CO_2,CS,p,5} = M_{CO_2,CS,p,4} \times FCF$$

where

$M_{CO_2,CS,c,4}$ and $M_{CO_2,CS,p,4}$ are the CO₂ mass emissions over the complete WLTC, c, and the cycle phases, p, resulting from the previous calculation step, g/km;

$M_{CO_2,CS,c,5}$ and $M_{CO_2,CS,p,5}$ are the CO₂ mass emissions over the complete WLTC, c, and the cycle phases, p, including the ATCT correction, and shall be used for any further corrections or any further calculations, g/km.

- 3.8.4. If a *FCF* is less than one, it is deemed to be equal to one, in the case of the worstcase approach, in accordance with paragraph 4.1 of this Annex B6a.

- 3.9. Provision for cool down

- 3.9.1. For the test vehicle serving as a reference vehicle for the ATCT Family and all vehicles H of the interpolation families within the ATCT Family, the end temperature of the engine coolant shall be measured after soaking at 23 °C for the duration of t_{soak_ATCT} , with a tolerance of an additional 15 minutes, having beforehand driven the respective Type 1 test at 23 °C. The duration is measured from the end of that respective Type 1 test.

- 3.9.1.1. In the case that t_{soak_ATCT} was extended in the respective ATCT test, the same soaking time shall be used, with a tolerance of an additional 15 minutes.

- 3.9.2. The cool down procedure shall be undertaken as soon as possible after the end of the Type 1 test, with a maximum delay of 20 minutes. The measured soaking time is the time between the measurement of the end temperature and the end of the Type 1 test at 23 °C, and shall be included in all relevant test sheets.

- 3.9.3. The average temperature of the soak area of the last 3 hours shall be subtracted from the measured temperature of the engine coolant at the end of the soaking time specified in paragraph 3.9.1. This is referred to as Δ_{T_ATCT} , rounded to the nearest whole number.

- 3.9.4. If Δ_{T_ATCT} is higher or equal than -2 °C from the test vehicle Δ_{T_ATCT} , this Interpolation Family shall be considered to be a member of the same ATCT Family.

- 3.9.5. For all vehicles within an ATCT Family the coolant shall be measured at the same location in the cooling system. That location shall be as close as possible to the engine so that the coolant temperature is as representative as possible to the engine temperature.

- 3.9.6. The measurement of the temperature of the soak areas shall be as specified in paragraph 3.2.2.2. of this Annex B6a.

-
4. Alternatives in the measurement process
- 4.1. Worst case approach vehicle cool down or with regards to vehicle insulation
- On request by the manufacturer and with approval by the approval authority, the Type 1 test procedure for cool down may be applied instead of provisions of paragraph 3.6 of this Annex B6a. For that purpose:
- (a) The provisions of paragraph 2.7.2. of Annex B6 shall apply with the additional requirement of a minimum soak time of 9 hours.
 - (b) The engine temperature shall be within ± 2 °C of the set point T_{reg} before the start of the ATCT test. That temperature shall be included in all relevant test sheets. In this case, the provision for cool down described in paragraph 3.9. of this Annex B6a and the criteria on engine compartment insulation can be skipped for all vehicles in the family.
- This alternative is not allowed if the vehicle is equipped with an active heat storage device.
- The application of that approach shall be included in all relevant test reports.
- The requirements to document the insulation materials may be waived.
- 4.2. ATCT family composed of a single Interpolation family
- In the case, that the ATCT family consists of only one interpolation family, the provision for cool down described in paragraph 3.9. of this Annex B6a can be skipped. This shall be included in all relevant test reports.
- 4.3. Alternative engine temperature measurement
- In the case that measuring the coolant temperature is not feasible, on request of the manufacturer and with approval of the approval authority, instead of using the coolant temperature for the provision for cool down described in paragraph 3.9. of this Annex B6a, the engine oil temperature may be used. In that case, for all vehicles within the family the engine oil temperature shall be used.
- The application of that procedure shall be included in all relevant test reports.

Annex B7

Calculations

1. General requirements
 - 1.1. Unless explicitly stated otherwise in Annex B8, all requirements and procedures specified in this annex shall apply for NOVC-HEVs, OVC-HEVs, NOVC-FCHVs and PEVs.
 - 1.2. The calculation steps described in paragraph 1.4. of this annex shall be used for pure ICE vehicles only.
 - 1.3. Rounding of test results
 - 1.3.1. Intermediate steps in the calculations shall not be rounded unless intermediate rounding is required.
 - 1.3.2. The final criteria emission results shall be rounded according to paragraph 6.1.8. of this Regulation in one step to the number of places to the right of the decimal point indicated by the applicable emission standard plus one additional significant figure.
 - 1.3.3. The NO_x correction factor KH shall be reported rounded according to paragraph 6.1.8. of this Regulation to two places of decimal.
 - 1.3.4. The dilution factor DF shall be reported rounded according to paragraph 6.1.8. of this Regulation to two places of decimal.
 - 1.3.5. For information not related to standards, good engineering judgement shall be used.
 - 1.4. Stepwise procedure for calculating the final test results for vehicles using combustion engines

The results shall be calculated in the order described in Table A7/1. All applicable results in the column "Output" shall be recorded. The column "Process" describes the paragraphs to be used for calculation or contains additional calculations.

For the purpose of this table, the following nomenclature within the equations and results is used:

 - c complete applicable cycle (to be calculated both for results after 3-phases and for results after 4-phases);
 - p every applicable cycle phase;
 - i every applicable criteria emission component, without CO₂;
 - CO₂ CO₂ emission.

Table A7/1

Procedure for calculating final test results (FE applicable for the 3-phase WLTP only)

Step No.	Source	Input	Process	Output
1	Annex B6	Raw test results	Mass emissions Paragraphs 3. to 3.2.2. inclusive of this annex.	$M_{i,p,1}$, g/km; $M_{CO_2,p,1}$, g/km.
2	Output step 1	$M_{i,p,1}$, g/km; $M_{CO_2,p,1}$, g/km.	Calculation of combined cycle values: $M_{i,c,2} = \frac{\sum_p M_{i,p,1} \times d_p}{\sum_p d_p}$ $M_{CO_2,c,2} = \frac{\sum_p M_{CO_2,p,1} \times d_p}{\sum_p d_p}$ where: $M_{i/CO_2,c,2}$ are the emission results over the total cycle; d_p are the driven distances of the cycle phases, p.	$M_{i,c,2}$, g/km; $M_{CO_2,c,2}$, g/km.
2b This step is only applicable for results after 4 phases;	Output step 1 Output step 2	$M_{CO_2,p,1}$, g/km; $M_{CO_2,c,2}$, g/km.	Correction of CO ₂ results against the target speed and distance. Annex B6b. Note: As the distance is also corrected, from this calculation step onwards any reference to a driven distance shall be interpreted as a reference to the target distance.	$M_{CO_2,p,2b}$, g/km; $M_{CO_2,c,2b}$, g/km.
3	For results after 4 phases Output step 2b	$M_{CO_2,p,2b}$, g/km; $M_{CO_2,c,2b}$, g/km.	RCB correction Appendix 2 to Annex B6.	$M_{CO_2,p,3}$, g/km; $M_{CO_2,c,3}$, g/km.
	For results after 3 phases Output step 1 Output step 2	$M_{CO_2,p,1}$, g/km; $M_{CO_2,c,2}$, g/km.	RCB correction Appendix 2 to Annex B6.	$M_{CO_2,p,3}$, g/km; $M_{CO_2,c,3}$, g/km.
4a	Output step 2 Output step 3	$M_{i,c,2}$, g/km; $M_{CO_2,c,3}$, g/km.	Emissions test procedure for all vehicles equipped with periodically regenerating systems, K_i . Annex B6, Appendix 1. $M_{i,c,4} = K_i \times M_{i,c,2}$ or $M_{i,c,4} = K_i + M_{i,c,2}$ and $M_{CO_2,c,4} = K_{CO_2} \times M_{CO_2,c,3}$ or $M_{CO_2,c,4} = K_{CO_2} + M_{CO_2,c,3}$ Additive offset or multiplicative factor to be used according to K_i determination. If K_i is not applicable: $M_{i,c,4} = M_{i,c,2}$ $M_{CO_2,c,4} = M_{CO_2,c,3}$	$M_{i,c,4a}$, g/km; $M_{CO_2,c,4a}$, g/km.

4b	Output step 3 Output step 4a	$M_{CO_2,p,3}$, g/km; $M_{CO_2,c,3}$, g/km; $M_{CO_2,c,4a}$, g/km.	If K_i is applicable, align CO_2 phase values to the combined cycle value: $M_{CO_2,p,4} = M_{CO_2,p,3} \times AF_{K_i}$ for every cycle phase p ; where: $AF_{K_i} = \frac{M_{CO_2,c,4}}{M_{CO_2,c,3}}$ If K_i is not applicable: $M_{CO_2,p,4} = M_{CO_2,p,3}$	$M_{CO_2,p,4}$, g/km.
4c	For results after 4 phases Output step 4a	$M_{i,c,4a}$, g/km; $M_{CO_2,c,4a}$, g/km.	In the case these values are used for the purpose of conformity of production, the criteria emission values and CO_2 mass emission values shall be multiplied with the run-in factor determined according to paragraph 8.2.4 of this Regulation: $M_{i,c,4c} = RI_C(j) \times M_{i,c,4a}$ $M_{CO_2,c,4c} = RI_{CO_2}(j) \times M_{CO_2,c,4a}$ In the case these values are not used for the purpose of conformity of production: $M_{i,c,4c} = M_{i,c,4a}$ $M_{CO_2,c,4c} = M_{CO_2,c,4a}$	$M_{i,c,4c}$; $M_{CO_2,c,4c}$
	For results after 3 phases Output step 4a	$M_{i,c,4a}$, g/km; $M_{CO_2,c,4a}$, g/km.	Calculate fuel efficiency ($FE_{c,4c_temp}$) according to paragraph 6. of Annex B6. In the case this value is used for the purpose of conformity of production, the fuel efficiency value shall be multiplied with the run in factor determined according to paragraph 8.2.4 of this Regulation: $FE_{c,4c} = RI_{FE}(j) \times FE_{c,4c_temp}$ In the case these values are not used for the purpose of conformity of production: $FE_{c,4c} = FE_{c,4c_temp}$	$FE_{c,4c}$, km/l;
5	For results after 4 phases Output step 4b and 4c	$M_{CO_2,c,4c}$, g/km; $M_{CO_2,p,4}$, g/km.	ATCT correction in accordance with paragraph 3.8.2. of Annex B6a. $M_{CO_2,c,5} = M_{CO_2,c,4c}$ $M_{CO_2,p,5} = M_{CO_2,p,4}$	$M_{CO_2,c,5}$, g/km; $M_{CO_2,p,5}$, g/km.
	Output step 4b and 4c	$M_{i,c,4c}$, g/km; $FE_{c,4c}$, km/l;	Apply deterioration factors calculated in accordance with Annex C4 to the criteria emissions values. $M_{i,c,5} = M_{i,c,4c}$ In the case these values are used for the purpose of conformity of production, the further steps (6 to 10) are not required and the output of this step is the final result.	$M_{i,c,5}$, g/km; $FE_{c,5}$, km/l;
6	For results after 4 phases Output step 5	For every test: $M_{i,c,5}$, g/km; $M_{CO_2,c,5}$, g/km; $M_{CO_2,p,5}$, g/km.	Averaging of tests and declared value. Paragraphs 1.2. to 1.2.3. inclusive of Annex B6.	$M_{i,c,6}$, g/km; $M_{CO_2,c,6}$, g/km; $M_{CO_2,p,6}$, g/km. $M_{CO_2,c,declared}$, g/km.

	For results after 3 phases Output step 5	$FE_{c,5}$, km/l;	Averaging of tests and declared value. Paragraphs 1.2. to 1.2.3. inclusive of Annex B6. The conversion from $FE_{c,declared}$ to $M_{CO_2,c,declared}$, shall be performed for the applicable cycle according to paragraph 6. of Annex B7. For that purpose, the criteria emission over the applicable cycle shall be used.	$FE_{c,declared}$, km/l $FE_{c,6}$, km/l $M_{CO_2,c,declared}$, g/km.
7	Output step 6	$M_{i,c,6}$, g/km; $M_{CO_2,c,6}$, g/km; $M_{CO_2,p,6}$, g/km. $M_{CO_2,c,declared}$, g/km.	Alignment of phase values. Paragraph 1.2.4. of Annex B6. and: $M_{CO_2,c,7} = M_{CO_2,c,declared}$	$M_{CO_2,c,7}$, g/km; $M_{CO_2,p,7}$, g/km.
8	Output steps 6 Output steps 7 Result of a Type 1 test for a test vehicle.	$M_{i,c,6}$, g/km; $M_{CO_2,c,7}$, g/km; $M_{CO_2,p,7}$, g/km.	Calculation of fuel consumption and conversion to fuel efficiency for phase value only. Paragraph 6 of this annex. The calculation of fuel consumption shall be performed for the applicable cycle and its phases separately. For that purpose: (a) the applicable phase or cycle CO ₂ values shall be used; (b) the criteria emission over the complete cycle shall be used. and: $M_{i,c,8} = M_{i,c,6}$ $M_{CO_2,c,8} = M_{CO_2,c,7}$ $M_{CO_2,p,8} = M_{CO_2,p,7}$	$FC_{c,8}$, l/100 km; $FC_{p,8}$, l/100 km; $FE_{c,8}$, km/l $FE_{p,8}$, km/l $M_{i,c,8}$, g/km; $M_{CO_2,c,8}$, g/km; $M_{CO_2,p,8}$, g/km.
9	Output step 8 Interpolation family result. For results after 4 phases Final criteria emission result	For each of the test vehicles H and L: $M_{i,c,8}$, g/km; $M_{CO_2,c,8}$, g/km; $M_{CO_2,p,8}$, g/km; $FC_{c,8}$, l/100 km; $FC_{p,8}$, l/100 km; $FE_{c,8}$, km/l. $FE_{p,8}$, km/l	For results after 4 phases; If in addition to a test vehicle H a test vehicle L and, if applicable vehicle M was also tested, the resulting criteria emission value shall be the highest of the two or, if applicable, three values and referred to as $M_{i,c}$. In the case of the combined THC + NO _x emissions, the highest value of the sum referring to either the VH or VL is to be used. Otherwise, if no vehicle L was tested, $M_{i,c} = M_{i,c,8}$ For CO ₂ , FE and FC, the values derived in step 8 shall be used, and CO ₂ values shall be rounded according to paragraph 6.1.8. of this Regulation to two places of decimal, and FE and FC values shall be rounded according to paragraph 6.1.8. of this Regulation to three places of decimal.	$M_{i,c}$, g/km; $M_{CO_2,c,H}$, g/km; $M_{CO_2,p,H}$, g/km; $FC_{c,H}$, l/100 km; $FC_{p,H}$, l/100 km; $FE_{c,H}$, km/l; $FE_{p,H}$, km/l; and if a vehicle L was tested: $M_{CO_2,c,L}$, g/km; $M_{CO_2,p,L}$, g/km; $FC_{c,L}$, l/100 km; $FC_{p,L}$, l/100 km; $FE_{c,L}$, km/l. $FE_{p,L}$, km/l.
10	Output step 9 Result of an individual vehicle. Final CO ₂ , FE and FC result.	$M_{CO_2,c,H}$, g/km; $M_{CO_2,p,H}$, g/km; $FC_{c,H}$, l/100 km; $FC_{p,H}$, l/100 km; $FE_{c,H}$, km/l;	Fuel consumption, fuel efficiency and CO ₂ calculations for individual vehicles in an interpolation family. Paragraph 3.2.3. of this annex.	$M_{CO_2,c,ind}$ g/km; $M_{CO_2,p,ind}$, g/km; $FC_{c,ind}$ l/100 km; $FC_{p,ind}$, l/100 km $FE_{c,ind}$, km/l.

		$FE_{p,H}$, km/l; and if a vehicle L was tested: $M_{CO_2,c,L}$, g/km; $M_{CO_2,p,L}$, g/km; $FC_{c,L}$, l/100 km; $FC_{p,L}$, l/100 km. $FE_{c,L}$, km/l; $FE_{p,L}$, km/l.	Fuel consumption, fuel efficiency and CO ₂ calculations for individual vehicles in a road load matrix family Paragraph 3.2.4. of this annex. CO ₂ emissions shall be expressed in grams per kilometre (g/km) rounded to the nearest whole number; FC values shall be rounded according to paragraph 6.1.8. of this Regulation to one place of decimal, expressed in (l/100 km) ; FE values shall be rounded according to paragraph 6.1.8. of this Regulation to one place of decimal, expressed in (km/l).	$FE_{p,ind}$, km/l
--	--	--	--	---------------------

2. Determination of diluted exhaust gas volume
- 2.1. Volume calculation for a variable dilution device capable of operating at a constant or variable flow rate
 The volumetric flow shall be measured continuously. The total volume shall be measured for the duration of the test.
- 2.2. Volume calculation for a variable dilution device using a positive displacement pump
- 2.2.1. The volume shall be calculated using the following equation:

$$V = V_0 \times N$$

where:

- V is the volume of the diluted gas, in litres per test (prior to correction);
 V_0 is the volume of gas delivered by the positive displacement pump in testing conditions, litres per pump revolution;
 N is the number of revolutions per test.

- 2.2.1.1. Correcting the volume to standard conditions

The diluted exhaust gas volume, V , shall be corrected to standard conditions according to the following equation:

$$V_{mix} = V \times K_1 \times \left(\frac{P_B - P_1}{T_p} \right)$$

where:

$$K_1 = \frac{273.15 \text{ (K)}}{101.325 \text{ (kPa)}} = 2.6961$$

- P_B is the test room barometric pressure, kPa;
 P_1 is the vacuum at the inlet of the positive displacement pump relative to the ambient barometric pressure, kPa;
 T_p is the arithmetic average temperature of the diluted exhaust gas entering the positive displacement pump during the test, Kelvin (K).

3. Mass emissions
- 3.1. General requirements (as applicable)
- 3.1.1. Assuming no compressibility effects, all gases involved in the engine's intake, combustion and exhaust processes may be considered to be ideal according to Avogadro's hypothesis.

- 3.1.2. The mass M of gaseous compounds emitted by the vehicle during the test shall be determined by the product of the volumetric concentration of the gas in question and the volume of the diluted exhaust gas with due regard for the following densities under the reference conditions of 273.15 K (0 °C) and 101.325 kPa:

Carbon monoxide (CO)	$\rho = 1.25 \text{ g/l}$
Carbon dioxide (CO ₂)	$\rho = 1.964 \text{ g/l}$
Hydrocarbons:	
for petrol (E0) (C ₁ H _{1.85})	$\rho = 0.619 \text{ g/l}$
for petrol (E10) (C ₁ H _{1.93} O _{0.033})	$\rho = 0.646 \text{ g/l}$
for diesel (B0) (C ₁ H _{1.86})	$\rho = 0.620 \text{ g/l}$
for diesel (B7) (C ₁ H _{1.86} O _{0.007})	$\rho = 0.625 \text{ g/l}$
for LPG (C ₁ H _{2.525})	$\rho = 0.649 \text{ g/l}$
for NG/biomethane (CH ₄)	$\rho = 0.716 \text{ g/l}$
for ethanol (E85) (C ₁ H _{2.74} O _{0.385})	$\rho = 0.934 \text{ g/l}$
Nitrogen oxides (NO _x)	$\rho = 2.05 \text{ g/l}$

The density for NMHC mass calculations shall be equal to that of total hydrocarbons at 273.15 K (0 °C) and 101.325 kPa, and is fuel-dependent. The density for propane mass calculations (see paragraph 3.5. of Annex B5) is 1.967 g/l at standard conditions.

If a fuel type is not listed in this paragraph, the density of that fuel shall be calculated using the equation given in paragraph 3.1.3. of this annex.

- 3.1.3. The general equation for the calculation of total hydrocarbon density for each reference fuel with a mean composition of C_xH_yO_z is as follows:

$$\rho_{\text{THC}} = \frac{MW_{\text{C}} + \frac{\text{H}}{\text{C}} \times MW_{\text{H}} + \frac{\text{O}}{\text{C}} \times MW_{\text{O}}}{V_{\text{M}}}$$

where:

ρ_{THC} is the density of total hydrocarbons and non-methane hydrocarbons, g/l;

MW_{C} is the molar mass of carbon (12.011 g/mol);

MW_{H} is the molar mass of hydrogen (1.008 g/mol);

MW_{O} is the molar mass of oxygen (15.999 g/mol);

V_{M} is the molar volume of an ideal gas at 273.15 K (0° C) and 101.325 kPa (22.413 l/mol);

H/C is the hydrogen to carbon ratio for a specific fuel C_xH_yO_z;

O/C is the oxygen to carbon ratio for a specific fuel C_xH_yO_z.

- 3.2. Mass emissions calculation

- 3.2.1. Mass emissions of gaseous compounds per cycle phase shall be calculated using the following equations:

$$M_{i,\text{phase}} = \frac{V_{\text{mix,phase}} \times \rho_i \times KH_{\text{phase}} \times C_{i,\text{phase}} \times 10^{-6}}{d_{\text{phase}}}$$

where:

M_i is the mass emission of compound i per test or phase, g/km;

- V_{mix} is the volume of the diluted exhaust gas per test or phase expressed in litres per test/phase and corrected to standard conditions (273.15 K (0 °C) and 101.325 kPa);
- ρ_i is the density of compound i in grams per litre at standard temperature and pressure (273.15 K (0 °C) and 101.325 kPa);
- KH is a humidity correction factor applicable only to the mass emissions of oxides of nitrogen, NO₂ and NO_x, per test or phase;
- C_i is the concentration of compound i per test or phase in the diluted exhaust gas expressed in ppm and corrected by the amount of compound i contained in the dilution air;
- d is the distance driven over the applicable WLTC, km;
- n is the number of phases of the applicable WLTC.

3.2.1.1. The concentration of a gaseous compound in the diluted exhaust gas shall be corrected by the amount of the gaseous compound in the dilution air using the following equation:

$$C_i = C_e - C_d \times \left(1 - \frac{1}{DF}\right)$$

where:

- C_i is the concentration of gaseous compound i in the diluted exhaust gas corrected by the amount of gaseous compound i contained in the dilution air, ppm;
- C_e is the measured concentration of gaseous compound i in the diluted exhaust gas, ppm;
- C_d is the concentration of gaseous compound i in the dilution air, ppm;
- DF is the dilution factor.

3.2.1.1.1. The dilution factor DF shall be calculated using the equation for the concerned fuel (as applicable):

$$DF = \frac{13.4}{C_{\text{CO}_2} + (C_{\text{HC}} + C_{\text{CO}}) \times 10^{-4}} \quad \text{for petrol (E10) and diesel (B0)}$$

$$DF = \frac{13.5}{C_{\text{CO}_2} + (C_{\text{HC}} + C_{\text{CO}}) \times 10^{-4}} \quad \text{for petrol (E0)}$$

$$DF = \frac{13.5}{C_{\text{CO}_2} + (C_{\text{HC}} + C_{\text{CO}}) \times 10^{-4}} \quad \text{for diesel (B7)}$$

$$DF = \frac{11.9}{C_{\text{CO}_2} + (C_{\text{HC}} + C_{\text{CO}}) \times 10^{-4}} \quad \text{for LPG}$$

$$DF = \frac{9.5}{C_{\text{CO}_2} + (C_{\text{HC}} + C_{\text{CO}}) \times 10^{-4}} \quad \text{for NG/biomethane}$$

$$DF = \frac{12.5}{C_{\text{CO}_2} + (C_{\text{HC}} + C_{\text{CO}}) \times 10^{-4}} \quad \text{for ethanol (E85)}$$

$$DF = \frac{35.03}{C_{\text{H}_2\text{O}} - C_{\text{H}_2\text{O-DA}} + C_{\text{H}_2} \times 10^{-4}} \quad \text{for hydrogen}$$

With respect to the equation for hydrogen:

- $C_{\text{H}_2\text{O}}$ is the concentration of H₂O in the diluted exhaust gas contained in the sample bag, per cent volume;
- $C_{\text{H}_2\text{O-DA}}$ is the concentration of H₂O in the dilution air, per cent volume;
- C_{H_2} is the concentration of H₂ in the diluted exhaust gas contained in the sample bag, ppm.

If a fuel type is not listed in this paragraph, the DF for that fuel shall be calculated using the equations in paragraph 3.2.1.1.2. of this annex.

If the manufacturer uses a DF that covers several phases, it shall calculate a DF using the mean concentration of gaseous compounds for the phases concerned.

The mean concentration of a gaseous compound shall be calculated using the following equation:

$$\bar{C}_1 = \frac{\sum_{\text{phase}=1}^n (C_{i,\text{phase}} \times V_{\text{mix,phase}})}{\sum_{\text{phase}=1}^n V_{\text{mix,phase}}}$$

where:

\bar{C}_1 is mean concentration of a gaseous compound;

$C_{i,\text{phase}}$ is the concentration of each phase;

$V_{\text{mix,phase}}$ is the V_{mix} of the corresponding phase;

n is the number of phases.

- 3.2.1.1.2. The general equation for calculating the dilution factor DF for each reference fuel with an arithmetic average composition of $C_xH_yO_z$ is as follows:

$$DF = \frac{X}{C_{CO_2} + (C_{HC} + C_{CO}) \times 10^{-4}}$$

where:

$$X = 100 \times \frac{x}{x + \frac{y}{2} + 3.76 \left(x + \frac{y}{4} - \frac{z}{2} \right)}$$

C_{CO_2} is the concentration of CO_2 in the diluted exhaust gas contained in the sample bag, per cent volume;

C_{HC} is the concentration of HC in the diluted exhaust gas contained in the sample bag, ppm carbon equivalent;

C_{CO} is the concentration of CO in the diluted exhaust gas contained in the sample bag, ppm.

- 3.2.1.1.3. Methane measurement

- 3.2.1.1.3.1. For methane measurement using a GC-FID, NMHC shall be calculated using the following equation:

$$C_{NMHC} = C_{THC} - (Rf_{CH_4} \times C_{CH_4})$$

where:

C_{NMHC} is the corrected concentration of NMHC in the diluted exhaust gas, ppm carbon equivalent;

C_{THC} is the concentration of THC in the diluted exhaust gas, ppm carbon equivalent and corrected by the amount of THC contained in the dilution air;

C_{CH_4} is the concentration of CH_4 in the diluted exhaust gas, ppm carbon equivalent and corrected by the amount of CH_4 contained in the dilution air;

Rf_{CH_4} is the FID response factor to methane determined and specified in paragraph 5.4.3.2. of Annex B5.

- 3.2.1.1.3.2. For methane measurement using an NMC-FID, the calculation of NMHC depends on the calibration gas/method used for the zero/calibration adjustment.

The FID used for the THC measurement (without NMC) shall be calibrated with propane/air in the normal manner.

For the calibration of the FID in series with an NMC, the following methods are permitted:

- (a) The calibration gas consisting of propane/air bypasses the NMC;
- (b) The calibration gas consisting of methane/air passes through the NMC.

It is highly recommended to calibrate the methane FID with methane/air through the NMC.

In case (a), the concentration of CH₄ and NMHC shall be calculated using the following equations:

$$C_{\text{CH}_4} = \frac{C_{\text{HC(w/NMC)}} - C_{\text{HC(w/oNMC)}} \times (1 - E_E)}{Rf_{\text{CH}_4} \times (E_E - E_M)}$$

$$C_{\text{NMHC}} = \frac{C_{\text{HC(w/oNMC)}} \times (1 - E_M) - C_{\text{HC(w/NMC)}}}{E_E - E_M}$$

If $Rf_{\text{CH}_4} < 1.05$, it may be omitted from the equation above for C_{CH_4} .

In case (b), the concentration of CH₄ and NMHC shall be calculated using the following equations:

$$C_{\text{CH}_4} = \frac{C_{\text{HC(w/NMC)}} \times Rf_{\text{CH}_4} \times (1 - E_M) - C_{\text{HC(w/oNMC)}} \times (1 - E_E)}{Rf_{\text{CH}_4} \times (E_E - E_M)}$$

$$C_{\text{NMHC}} = \frac{C_{\text{HC(w/oNMC)}} \times (1 - E_M) - C_{\text{HC(w/NMC)}} \times Rf_{\text{CH}_4} \times (1 - E_M)}{E_E - E_M}$$

where:

$C_{\text{HC(w/NMC)}}$ is the HC concentration with sample gas flowing through the NMC, ppm C;

$C_{\text{HC(w/oNMC)}}$ is the HC concentration with sample gas bypassing the NMC, ppm C;

Rf_{CH_4} is the methane response factor as determined per paragraph 5.4.3.2. of Annex B5;

E_M is the methane efficiency as determined per paragraph 3.2.1.1.3.3.1. of this annex;

E_E is the ethane efficiency as determined per paragraph 3.2.1.1.3.3.2. of this annex.

If $Rf_{\text{CH}_4} < 1.05$, it may be omitted in the equations for case (b) above for C_{CH_4} and C_{NMHC} .

3.2.1.1.3.3. Conversion efficiencies of the non-methane cutter, NMC

The NMC is used for the removal of the non-methane hydrocarbons from the sample gas by oxidizing all hydrocarbons except methane. Ideally, the conversion for methane is 0 per cent, and for the other hydrocarbons represented by ethane is 100 per cent. For the accurate measurement of NMHC, the two efficiencies shall be determined and used for the calculation of the NMHC emission.

3.2.1.1.3.3.1. Methane conversion efficiency, E_M

The methane/air calibration gas shall be flowed to the FID through the NMC and bypassing the NMC and the two concentrations recorded. The efficiency shall be determined using the following equation:

$$E_M = 1 - \frac{C_{\text{HC(w/NMC)}}}{C_{\text{HC(w/oNMC)}}$$

where:

$C_{\text{HC(w/NMC)}}$ is the HC concentration with CH_4 flowing through the NMC, ppm C;

$C_{\text{HC(w/oNMC)}}$ is the HC concentration with CH_4 bypassing the NMC, ppm C.

3.2.1.1.3.3.2. Ethane conversion efficiency, E_E

The ethane/air calibration gas shall be flowed to the FID through the NMC and bypassing the NMC and the two concentrations recorded. The efficiency shall be determined using the following equation:

$$E_E = 1 - \frac{C_{\text{HC(w/NMC)}}}{C_{\text{HC(w/oNMC)}}$$

where:

$C_{\text{HC(w/NMC)}}$ is the HC concentration with C_2H_6 flowing through the NMC, ppm C;

$C_{\text{HC(w/oNMC)}}$ is the HC concentration with C_2H_6 bypassing the NMC, ppm C.

If the ethane conversion efficiency of the NMC is 0.98 or above, E_E shall be set to 1 for any subsequent calculation.

3.2.1.1.3.4. If the methane FID is calibrated through the cutter, E_M shall be 0.

The equation to calculate C_{CH_4} in paragraph 3.2.1.1.3.2. (case (b)) in this annex becomes:

$$C_{\text{CH}_4} = C_{\text{HC(w/NMC)}}$$

The equation to calculate C_{NMHC} in paragraph 3.2.1.1.3.2. (case (b)) in this annex becomes:

$$C_{\text{NMHC}} = C_{\text{HC(w/oNMC)}} - C_{\text{HC(w/NMC)}} \times r_h$$

The density used for NMHC mass calculations shall be equal to that of total hydrocarbons at 273.15 K (0 °C) and 101.325 kPa and is fuel-dependent.

3.2.1.1.4. Flow-weighted arithmetic average concentration calculation

The following calculation method shall be applied for CVS systems that are not equipped with a heat exchanger or for CVS systems with a heat exchanger that do not comply with paragraph 3.3.5.1. of Annex B5.

This flow weighted arithmetic average concentration calculation shall be used for all continuous diluted measurements including PN (if PN measurement is required). It may be optionally applied for CVS systems with a heat exchanger that complies with paragraph 3.3.5.1 of Annex B5.

$$C_e = \frac{\sum_{i=1}^n q_{\text{CVS}}(i) \times \Delta t \times C(i)}{V}$$

where:

C_e is the flow-weighted arithmetic average concentration;

$q_{\text{CVS}}(i)$ is the CVS flow rate at time $t = i \times \Delta t$, m^3/sec ;

$C(i)$ is the concentration at time $t = i \times \Delta t$, ppm;

Δt sampling interval, s;

V total CVS volume, m^3 ;

n is the test time, s.

3.2.1.2. Calculation of the NO_x humidity correction factor

In order to correct the influence of humidity on the results of oxides of nitrogen, the following calculations apply:

$$KH = \frac{1}{1 - 0.0329 \times (H - 10.71)}$$

where:

$$H = \frac{6.211 \times R_a \times P_d}{P_B - P_d \times R_a \times 10^{-2}}$$

and:

H is the specific humidity, grams of water vapour per kilogram dry air;

R_a is the relative humidity of the ambient air, per cent;

P_d is the saturation vapour pressure at ambient temperature, kPa;

P_B is the atmospheric pressure in the room, kPa.

The KH factor shall be calculated for each phase of the test cycle.

The ambient temperature and relative humidity shall be defined as the arithmetic average of the continuously measured values during each phase.

3.2.2. Determination of the HC mass emissions from compression-ignition engines

3.2.2.1. To calculate HC mass emission for compression-ignition engines, the arithmetic average HC concentration shall be calculated using the following equation:

$$C_e = \frac{\int_{t_1}^{t_2} C_{HC} dt}{t_2 - t_1}$$

where:

$\int_{t_1}^{t_2} C_{HC} dt$ is the integral of the recording of the heated FID over the test (t₁ to t₂);

C_e is the concentration of HC measured in the diluted exhaust in ppm of C_i and is substituted for C_{HC} in all relevant equations.

3.2.2.1.1. Dilution air concentration of HC shall be determined from the dilution air bags. Correction shall be carried out according to paragraph 3.2.1.1. of this annex.

3.2.3. Fuel consumption, fuel efficiency and CO₂ calculations for individual vehicles in an interpolation family

3.2.3.1. Fuel consumption, fuel efficiency and CO₂ emissions without using the interpolation method (i.e. using vehicle H only)

The CO₂ value, as calculated in paragraphs 3.2.1. to 3.2.1.1.2. inclusive of this annex, and fuel efficiency/fuel consumption, as calculated according to paragraph 6. of this annex, shall be attributed to all individual vehicles in the interpolation family and the interpolation method shall not be applicable.

3.2.3.2. Fuel consumption and CO₂ emissions using the interpolation method

The CO₂ emissions and the fuel consumption for each individual vehicle in the interpolation family may be calculated according to paragraphs 3.2.3.2.1. to 3.2.3.2.5. inclusive of this annex.

3.2.3.2.1. Fuel consumption and CO₂ emissions of test vehicles L and H

The mass of CO₂ emissions, M_{CO₂-L}, and M_{CO₂-H} and its phases p, M_{CO₂-L,p} and M_{CO₂-H,p}, of test vehicles L and H, used for the following calculations, shall be taken from step 9 of Table A7/1.

Fuel consumption values are also taken from step 9 of Table A7/1 and are referred to as FC_{L,p} and FC_{H,p}.

3.2.3.2.2. Road load calculation for an individual vehicle

In the case that the interpolation family is derived from one or more road load families, the calculation of the individual road load shall only be performed within the road load family applicable to that individual vehicle.

3.2.3.2.2.1. Mass of an individual vehicle

The test masses of vehicles H and L shall be used as input for the interpolation method.

TM_{ind} , in kg, shall be the individual test mass of the vehicle according to paragraph 3.2.25. of this Regulation.

If the same test mass is used for test vehicles L and H, the value of TM_{ind} shall be set to the mass of test vehicle H for the interpolation method.

3.2.3.2.2.2. Rolling resistance of an individual vehicle

3.2.3.2.2.2.1. The actual RRC values for the selected tyres on test vehicle L, RR_L , and test vehicle H, RR_H , shall be used as input for the interpolation method. See paragraph 4.2.2.1. of Annex B4.

If the tyres on the front and rear axles of vehicle L or H have different RRC values, the weighted mean of the rolling resistances shall be calculated using the equation in paragraph 3.2.3.2.2.2.3. of this annex.

3.2.3.2.2.2.2. For the tyres fitted to an individual vehicle, the value of the rolling resistance coefficient RR_{ind} shall be set to the RRC value of the applicable tyre energy efficiency class according to Table A4/2 of Annex B4.

In the case where individual vehicles can be supplied with a complete set of standard wheels and tyres and in addition a complete set of snow tyres (marked with 3 Peaked Mountain and Snowflake – 3PMS) with or without wheels, the additional wheels/tyres shall not be considered as optional equipment.

If the tyres on the front and rear axles belong to different energy efficiency classes, the weighted mean shall be used and calculated using the equation in paragraph 3.2.3.2.2.2.3. of this annex.

If the same tyres, or tyres with the same rolling resistance coefficient were fitted to test vehicles L and H, the value of RR_{ind} for the interpolation method shall be set to RR_H .

3.2.3.2.2.2.3. Calculating the weighted mean of the rolling resistances

$$RR_x = (RR_{x,FA} \times mp_{x,FA}) + (RR_{x,RA} \times (1 - mp_{x,FA}))$$

where:

x represents vehicle L, H or an individual vehicle.

$RR_{L,FA}$ and $RR_{H,FA}$ are the actual RRCs of the front axle tyres on vehicles L and H respectively, kg/tonne;

$RR_{ind,FA}$ is the RRC value of the applicable tyre energy efficiency class according to Table A4/2 of Annex B4 of the front axle tyres on the individual vehicle, kg/tonne;

$RR_{L,RA}$, and $RR_{H,RA}$ are the actual RRCs of the rear axle tyres on vehicles L and H respectively, kg/tonne;

$RR_{ind,RA}$ is the RRC value of the applicable tyre energy efficiency class according to Table A4/2 of Annex B4 of the rear axle tyres on the individual vehicle, kg/tonne;

$mp_{x,FA}$ is the proportion of the vehicle mass in running order on the front axle;

RR_x shall not be rounded or categorised to tyre energy efficiency classes.

3.2.3.2.2.3. Aerodynamic drag of an individual vehicle

3.2.3.2.2.3.1. Determination of aerodynamic influence of optional equipment

The aerodynamic drag shall be measured for each of the aerodynamic drag-influencing items of optional equipment and body shapes in a wind tunnel fulfilling the requirements of paragraph 3.2. of Annex B4 verified by the responsible authority.

For the purpose of the interpolation method, the aerodynamic drag of optional equipment within one road load family shall be measured at the same wind speed, either v_{low} or v_{high} , preferably v_{high} , as defined in paragraph 6.4.3. of Annex B4. In the case that v_{low} or v_{high} does not exist, (e.g. the road load of V_L and/or V_H are measured using the coastdown method), the aerodynamic force shall be measured at the same wind speed within the range ≥ 80 km/h and ≤ 150 km/h. For Class 1 vehicles, it shall be measured at the same wind speed of ≤ 150 km/h.

3.2.3.2.2.3.2. Alternative method for determination of aerodynamic influence of optional equipment

At the request of the manufacturer and with approval of the responsible authority, an alternative method (e.g. wind tunnel not fulfilling the criteria in Annex B4) may be used to determine $\Delta(C_D \times A_f)$ if the following criteria are fulfilled:

- (a) The alternative method shall fulfil an accuracy for $\Delta(C_D \times A_f)$ of ± 0.015 m².
- (b) The alternative method shall only be used for types of aerodynamic-influencing optional equipment (e.g. wheels, cooling air control systems, spoilers etc.) for which equivalency has been demonstrated;
- (c) Evidence of equivalency outlined in (a) and (b) shall be shown to the responsible authority in advance of the type approval for the road load family. For any alternative method, validation shall be based on wind tunnel measurements fulfilling the criteria of this Regulation;
- (d) If the $\Delta(C_D \times A_f)$ of a particular item of optional equipment is more than double the $\Delta(C_D \times A_f)$ of the optional equipment for which the evidence was provided, aerodynamic drag shall not be determined by the alternative method; and
- (e) Revalidation is necessary every four years in the case that a measurement method is used. In the case that a mathematical method is used, any change made to a simulation model or to the software likely to invalidate the validation report also requires revalidation.

3.2.3.2.2.3.2.1. The manufacturer shall submit the declared scope of applicable vehicles for the alternative method and the declared scope shall be documented to relevant test reports when evidence of equivalency is shown to the responsible authority. The responsible authority may request the confirmation of equivalency for the alternative method by selecting the vehicle from the scope declared by the manufacturer after equivalency was demonstrated. The result shall fulfil an accuracy for $\Delta(C_D \times A_f)$ of ± 0.015 m². This procedure shall be based on wind tunnel measurements fulfilling the criteria of this Regulation. If this procedure is not satisfied, the approval of the alternative method is regarded as invalidated.

3.2.3.2.2.3.3. Application of aerodynamic influence on the individual vehicle

$\Delta(C_D \times A_f)_{ind}$ is the difference in the product of the aerodynamic drag coefficient multiplied by frontal area between an individual vehicle and test vehicle L due to options and body shapes on the vehicle that differ from those of test vehicle L, m²;

These differences in aerodynamic drag, $\Delta(C_D \times A_f)$, shall be determined with an accuracy of $\pm 0.015 \text{ m}^2$.

$\Delta(C_D \times A_f)_{\text{ind}}$ may be calculated according to the following equation maintaining the accuracy of $\pm 0.015 \text{ m}^2$ also for the sum of items of optional equipment and body shapes:

$$\Delta(C_D \times A_f)_{\text{ind}} = \sum_{i=1}^n \Delta(C_D \times A_f)_i$$

where:

C_D is the aerodynamic drag coefficient;

A_f is the frontal area of the vehicle, m^2 ;

n is the number of items of optional equipment on the vehicle that are different between an individual vehicle and test vehicle L;

$\Delta(C_D \times A_f)_i$ is the difference in the product of the aerodynamic drag coefficient multiplied by frontal area due to an individual feature, i , on the vehicle and is positive for an item of optional equipment that adds aerodynamic drag with respect to test vehicle L and vice versa, m^2 .

The sum of all $\Delta(C_D \times A_f)_i$ differences between test vehicles L and H shall correspond to $\Delta(C_D \times A_f)_{\text{LH}}$.

3.2.3.2.2.3.4. Definition of complete aerodynamic delta between test vehicles L and H

The total difference of the aerodynamic drag coefficient multiplied by frontal area between test vehicles L and H shall be referred to as $\Delta(C_D \times A_f)_{\text{LH}}$ and shall be recorded, m^2 .

3.2.3.2.2.3.5. Documentation of aerodynamic influences

The increase or decrease of the product of the aerodynamic drag coefficient multiplied by frontal area expressed as $\Delta(C_D \times A_f)$ for all items of optional equipment and body shapes in the interpolation family that:

- (a) have an influence on the aerodynamic drag of the vehicle; and
- (b) are to be included in the interpolation,

shall be recorded, m^2 .

3.2.3.2.2.3.6. Additional provisions for aerodynamic influences

The aerodynamic drag of vehicle H shall be applied to the whole interpolation family and $\Delta(C_D \times A_f)_{\text{LH}}$ shall be set to zero, if:

- (a) the wind tunnel facility is not able to accurately determine $\Delta(C_D \times A_f)$;
or
- (b) there are no drag-influencing items of optional equipment between the test vehicles H and L that are to be included in the interpolation method.

3.2.3.2.2.4. Calculation of road load coefficients for individual vehicles

The road load coefficients f_0 , f_1 and f_2 (as defined in Annex B4) for test vehicles H and L are referred to as $f_{0,H}$, $f_{1,H}$ and $f_{2,H}$, and $f_{0,L}$, $f_{1,L}$ and $f_{2,L}$ respectively. An adjusted road load curve for the test vehicle L is defined as follows:

$$F_L(v) = f_{0,L}^* + f_{1,H} \times v + f_{2,L}^* \times v^2$$

Applying the least squares regression method in the range of the reference speed points, adjusted road load coefficients $f_{0,L}^*$ and $f_{2,L}^*$ shall be determined for $F_L(v)$ with the linear coefficient $f_{1,L}^*$ set to $f_{1,H}$. The road load coefficients

$f_{0,ind}$, $f_{1,ind}$ and $f_{2,ind}$ for an individual vehicle in the interpolation family shall be calculated using the following equations:

$$f_{0,ind} = f_{0,H} - \Delta f_0 \times \frac{(TM_H \times RR_H - TM_{ind} \times RR_{ind})}{(TM_H \times RR_H - TM_L \times RR_L)}$$

or, if $(TM_H \times RR_H - TM_L \times RR_L) = 0$, the equation for $f_{0,ind}$ below shall apply:

$$f_{0,ind} = f_{0,H} - \Delta f_0$$

$$f_{1,ind} = f_{1,H}$$

$$f_{2,ind} = f_{2,H} - \Delta f_2 \frac{(\Delta[C_D \times A_f]_{LH} - \Delta[C_d \times A_f]_{ind})}{(\Delta[C_D \times A_f]_{LH})}$$

or, if $\Delta(C_D \times A_f)_{LH} = 0$, the equation for $F_{2,ind}$ below shall apply:

$$f_{2,ind} = f_{2,H} - \Delta f_2$$

where:

$$\Delta f_0 = f_{0,H} - f_{0,L}^*$$

$$\Delta f_2 = f_{2,H} - f_{2,L}^*$$

In the case of a road load matrix family, the road load coefficients f_0 , f_1 and f_2 for an individual vehicle shall be calculated according to the equations in paragraph 5.1.1. of Annex B4.

3.2.3.2.3. Calculation of cycle energy demand

The cycle energy demand of the applicable WLTC E_k and the energy demand for all applicable cycle phases $E_{k,p}$ shall be calculated according to the procedure in paragraph 5. of this annex for the following sets k of road load coefficients and masses:

$$k=1: \quad f_0 = f_{0,L}^*, f_1 = f_{1,H}, f_2 = f_{2,L}^*, m = TM_L$$

(test vehicle L)

$$k=2: \quad f_0 = f_{0,H}, f_1 = f_{1,H}, f_2 = f_{2,H}, m = TM_H$$

(test vehicle H)

$$k=3: \quad f_0 = f_{0,ind}, f_1 = f_{1,H}, f_2 = f_{2,ind}, m = TM_{ind}$$

(an individual vehicle in the interpolation family)

These three sets of road loads may be derived from different road load families.

3.2.3.2.4. For 4-phase WLTP test only

Calculation of the CO₂ value for an individual vehicle within an interpolation family using the interpolation method

For each cycle phase p of the applicable cycle the mass of CO₂ emissions g/km, for an individual vehicle shall be calculated using the following equation:

$$M_{CO_2-ind,p} = M_{CO_2-L,p} + \left(\frac{E_{3,p} - E_{1,p}}{E_{2,p} - E_{1,p}} \right) \times (M_{CO_2-H,p} - M_{CO_2-L,p})$$

The mass of CO₂ emissions, g/km, over the complete cycle for an individual vehicle shall be calculated using the following equation:

$$M_{CO_2-ind} = M_{CO_2-L} + \left(\frac{E_3 - E_1}{E_2 - E_1} \right) \times (M_{CO_2-H} - M_{CO_2-L})$$

The terms $E_{1,p}$, $E_{2,p}$ and $E_{3,p}$ and E_1 , E_2 and E_3 respectively shall be calculated as specified in paragraph 3.2.3.2.3. of this annex.

3.2.3.2.5. For 4-phase WLTP test

Calculation of the fuel consumption FC value for an individual vehicle within an interpolation family using the interpolation method

For each cycle phase p of the applicable cycle, the fuel consumption, l/100 km, for an individual vehicle shall be calculated using the following equation:

$$FC_{ind,p} = FC_{L,p} + \left(\frac{E_{3,p} - E_{1,p}}{E_{2,p} - E_{1,p}} \right) \times (FC_{H,p} - FC_{L,p})$$

The fuel consumption, l/100 km, of the complete cycle for an individual vehicle shall be calculated using the following equation:

$$FC_{ind} = FC_L + \left(\frac{E_3 - E_1}{E_2 - E_1} \right) \times (FC_H - FC_L)$$

The terms $E_{1,p}$, $E_{2,p}$ and $E_{3,p}$, and E_1 , E_2 and E_3 respectively shall be calculated as specified in paragraph 3.2.3.2.3. of this annex.

For 3-phase WLTP test

Calculation of the fuel efficiency FE value for an individual vehicle within an interpolation family using the interpolation method

For each cycle phase p of the applicable cycle, the fuel efficiency, km/l, for an individual vehicle shall be calculated using the following equation:

$$FE_{ind,p} = \frac{1}{1/FE_{L,p} + \left(\frac{E_{3,p} - E_{1,p}}{E_{2,p} - E_{1,p}} \right) \times (1/FE_{H,p} - 1/FE_{L,p})}$$

The fuel efficiency, in km/l, of the complete cycle for an individual vehicle shall be calculated using the following equation:

$$FE_{ind} = \frac{1}{1/FE_L + \left(\frac{E_3 - E_1}{E_2 - E_1} \right) \times (1/FE_H - 1/FE_L)}$$

The terms $E_{1,p}$, $E_{2,p}$ and $E_{3,p}$, and E_1 , E_2 and E_3 respectively shall be calculated as specified in paragraph 3.2.3.2.3. of this annex.

3.2.3.2.6. For 4-phase WLTP test

The individual CO₂ value determined in paragraph 3.2.3.2.4. of this annex may be increased by the original equipment manufacturer (OEM). In such cases:

- (a) The CO₂ phase values shall be increased by the ratio of the increased CO₂ value divided by the calculated CO₂ value;
- (b) The fuel consumption values shall be increased by the ratio of the increased CO₂ value divided by the calculated CO₂ value.

This shall not compensate for technical elements that would effectively require a vehicle to be excluded from the interpolation family.

For 3-phase WLTP test

The individual fuel efficiency value determined in paragraph 3.2.3.2.5. of this annex may be decreased by the original equipment manufacturer (OEM). In such cases:

- (a) The fuel efficiency phase values shall be decreased by the ratio of the decreased fuel efficiency value divided by the calculated fuel efficiency value;

This shall not compensate for technical elements that would effectively require a vehicle to be excluded from the interpolation family.

3.2.4. Fuel consumption, fuel efficiency and CO₂ calculations for individual vehicles in a road load matrix family

The CO₂ emissions and the fuel efficiency/fuel consumption for each individual vehicle in the road load matrix family shall be calculated according to the interpolation method described in paragraphs 3.2.3.2.3. to 3.2.3.2.5. inclusive of this annex. Where applicable, references to vehicle L and/or H shall be replaced by references to vehicle L_M and/or H_M respectively.

3.2.4.1. Determination of fuel consumption, fuel efficiency and CO₂ emissions of vehicles L_M and H_M

The mass of CO₂ emissions M_{CO₂} of vehicles L_M and H_M shall be determined according to the calculations in paragraph 3.2.1. of this annex for the individual cycle phases p of the applicable WLTC and are referred to as M_{CO₂-L_M,p} and M_{CO₂-H_M,p} respectively. Fuel consumption and fuel efficiency for individual cycle phases of the applicable WLTC shall be determined according to paragraph 6. of this annex and are referred to as FC_{L_M,p}, FC_{H_M,p}, FE_{L_M,p} and FE_{H_M,p} respectively.

3.2.4.1.1. Road load calculation for an individual vehicle

The road load force shall be calculated according to the procedure described in paragraph 5.1. of Annex B4.

3.2.4.1.1.1. Mass of an individual vehicle

The test masses of vehicles H_M and L_M selected according to paragraph 4.2.1.4. of Annex B4 shall be used as input.

TM_{ind}, in kg, shall be the test mass of the individual vehicle according to the definition of test mass in paragraph 3.2.25. of this Regulation.

If the same test mass is used for vehicles L_M and H_M, the value of TM_{ind} shall be set to the mass of vehicle H_M for the road load matrix family method.

3.2.4.1.1.2. Rolling resistance of an individual vehicle

3.2.4.1.1.2.1. The RRC values for vehicle L_M, RR_{L_M}, and vehicle H_M, RR_{H_M}, selected under paragraph 4.2.1.4. of Annex B4, shall be used as input.

If the tyres on the front and rear axles of vehicle L_M or H_M have different rolling resistance values, the weighted mean of the rolling resistances shall be calculated using the equation in paragraph 3.2.4.1.1.2.3. of this annex.

3.2.4.1.1.2.2. For the tyres fitted to an individual vehicle, the value of the rolling resistance coefficient RR_{ind} shall be set to the RRC value of the applicable tyre energy efficiency class according to Table A4/2 of Annex B4.

In the case where individual vehicles can be supplied with a complete set of standard wheels and tyres and in addition complete set of snow tyres (marked with 3 Peaked Mountain and Snowflake – 3PMS) with or without wheels, the additional wheels/tyres shall not be considered as optional equipment.

If the tyres on the front and the rear axles belong to different energy efficiency classes, the weighted mean shall be used and shall be calculated using the equation in paragraph 3.2.4.1.1.2.3. of this annex.

If the same rolling resistance is used for vehicles L_M and H_M, the value of RR_{ind} shall be set to RR_{H_M} for the road load matrix family method.

3.2.4.1.1.2.3. Calculating the weighed mean of the rolling resistances

$$RR_x = (RR_{x,FA} \times mp_{x,FA}) + (RR_{x,RA} \times (1 - mp_{x,FA}))$$

where:

x	represents vehicle L, H or an individual vehicle;
$RR_{LM,FA}$ and $RR_{HM,FA}$	are the actual RRCs of the front axle tyres on vehicles L and H respectively, kg/tonne;
$RR_{ind,FA}$	is the RRC value of the applicable tyre energy efficiency class according to Table A4/2 of Annex B4 of the front axle tyres on the individual vehicle, kg/tonne;
$RR_{LM,RA}$, and $RR_{HM,RA}$	are the actual rolling resistance coefficients of the rear axle tyres on vehicles L and H respectively, kg/tonne;
$RR_{ind,RA}$	is the RRC value of the applicable tyre energy efficiency class according to Table A4/2 of Annex B4 of the rear axle tyres on the individual vehicle, kg/tonne;
$mp_{x,FA}$	is the proportion of the vehicle mass in running order on the front axle.

RR_x shall not be rounded or categorised to tyre energy efficiency classes.

3.2.4.1.1.3. Frontal area of an individual vehicle

The frontal area for vehicle L_M , A_{fLM} , and vehicle H_M , A_{fHM} , selected under paragraph 4.2.1.4. of Annex B4 shall be used as input.

$A_{f,ind}$, in m^2 , shall be the frontal area of the individual vehicle.

If the same frontal area is used for vehicles L_M and H_M , the value of $A_{f,ind}$ shall be set to the frontal area of vehicle H_M for the road load matrix family method.

3.2.5. Alternative interpolation calculation method

Upon request of the manufacturer and with approval of the responsible authority, a manufacturer may apply an alternative interpolation calculation procedure in the case that the interpolation method creates unrealistic phase-specific results or an unrealistic road load curve. Before such permission is granted, the manufacturer shall check and where possible correct:

- The reason for having small differences between the road load relevant characteristics between vehicle L and H in the case of unrealistic phase-specific results;
- The reason for having an unexpected difference between the $f_{1,L}$ and $f_{1,H}$ coefficients in the case of an unrealistic road load curve.

The request of the manufacturer to the responsible authority shall include evidence that such a correction is not possible, and that the resultant error is significant.

3.2.5.1. Alternative calculation to correct unrealistic phase-specific results

Alternatively to the procedures defined in paragraphs 3.2.3.2.4. and 3.2.3.2.5. of this annex, calculations of phase CO_2 , phase fuel efficiency and phase fuel consumption may be calculated according to the equations in paragraphs 3.2.5.1.1., 3.2.5.1.2. and 3.2.5.1.3. below.

3.2.5.1.1. Ratio determination for each phase of V_L and V_H

$$R_{p,L} = \frac{M_{CO_2,p,L}}{M_{CO_2,c,L}}$$

$$R_{p,H} = \frac{M_{CO_2,p,H}}{M_{CO_2,c,H}}$$

where:

$M_{CO_2,p,L}$, $M_{CO_2,c,L}$, $M_{CO_2,p,H}$ and $M_{CO_2,c,H}$ are from step 9 in Table A7/1 in this annex.

3.2.5.1.2. Ratio determination for each phase for vehicle V_{ind}

$$R_{p,ind} = R_{p,L} + \left(\frac{M_{CO_2,c,ind} - M_{CO_2,c,L}}{M_{CO_2,c,H} - M_{CO_2,c,L}} \right) \times (R_{p,H} - R_{p,L})$$

where:

$M_{CO_2,c,ind}$ is from step 10 in Table A7/1 in this annex and shall be rounded to the nearest whole number.

3.2.5.1.3. Phase per phase mass emission of vehicle V_{ind}

$$M_{CO_2,p,ind} = R_{p,ind} \times M_{CO_2,c,ind}$$

3.2.5.2. Alternative calculation to correct an unrealistic road load curve
Alternatively to the procedure defined in paragraph 3.2.3.2.2.4. of this annex, road load coefficients may be calculated as follows:

$$F_i(v) = f_{0,i}^* + f_{1,A} \times v + f_{2,i}^* \times v^2$$

Applying the least squares regression method in the range of the reference speed points, alternative adjusted road load coefficients $f_{0,i}^*$ and $f_{2,i}^*$ shall be determined for $F_i(v)$ with the linear coefficient $f_{1,i}^*$ set to $f_{1,A}$. $f_{1,A}$ is calculated as follows:

$$f_{1,A} = \frac{(E_i - E_{LR}) \times f_{1,HR} + (E_{HR} - E_i) \times f_{1,LR}}{(E_{HR} - E_{LR})}$$

where:

E is the cycle energy demand as defined in paragraph 5. of this annex, Ws ;

i is the subscript denoting vehicles L, H or ind;

H_R is test vehicle H as described in paragraph 4.2.1.2.3.2. of Annex B4;

L_R is test vehicle L as described in paragraph 4.2.1.2.3.2. of Annex B4.

3.3. PM

3.3.1. Calculation

PM shall be calculated using the following two equations:

$$PM = \frac{(V_{mix} + V_{ep}) \times P_e}{V_{ep} \times d}$$

where exhaust gases are vented outside tunnel;

and:

$$PM = \frac{V_{mix} \times P_e}{V_{ep} \times d}$$

where exhaust gases are returned to the tunnel;

where:

- V_{mix} is the volume of diluted exhaust gases (see paragraph 2. of this annex), under standard conditions;
- V_{ep} is the volume of diluted exhaust gas flowing through the particulate sampling filter under standard conditions;
- P_e is the mass of particulate matter collected by one or more sample filters, mg;
- d is the distance driven corresponding to the test cycle, km.

3.3.1.1. Where correction for the background particulate mass from the dilution system has been used, this shall be determined in accordance with paragraph 2.1.3.1. of Annex B6. In this case, particulate mass (mg/km) shall be calculated using the following equations:

$$\text{PM} = \left\{ \frac{P_e}{V_{\text{ep}}} - \left[\frac{P_a}{V_{\text{ap}}} \times \left(1 - \frac{1}{\text{DF}} \right) \right] \right\} \times \frac{(V_{\text{mix}} + V_{\text{ep}})}{d}$$

in the case that the exhaust gases are vented outside the tunnel;
and:

$$\text{PM} = \left\{ \frac{P_e}{V_{\text{ep}}} - \left[\frac{P_a}{V_{\text{ap}}} \times \left(1 - \frac{1}{\text{DF}} \right) \right] \right\} \times \frac{V_{\text{mix}}}{d}$$

in the case that the exhaust gases are returned to the tunnel;
where:

- V_{ap} is the volume of tunnel air flowing through the background particulate filter under standard conditions;
- P_a is the particulate mass from the dilution air, or the dilution tunnel background air, as determined by the one of the methods described in paragraph 2.1.3.1. of Annex B6;
- DF is the dilution factor determined in paragraph 3.2.1.1.1. of this annex.

Where application of a background correction results in a negative result, it shall be considered to be zero mg/km.

3.3.2. Calculation of PM using the double dilution method

$$V_{\text{ep}} = V_{\text{set}} - V_{\text{ssd}}$$

where:

- V_{ep} is the volume of diluted exhaust gas flowing through the particulate sample filter under standard conditions;
- V_{set} is the volume of the double diluted exhaust gas passing through the particulate sampling filters under standard conditions;
- V_{ssd} is the volume of the secondary dilution air under standard conditions.

Where the secondary diluted sample gas for PM measurement is not returned to the tunnel, the CVS volume shall be calculated as in single dilution, i.e.:

$$V_{\text{mix}} = V_{\text{mix indicated}} + V_{\text{ep}}$$

where:

- $V_{\text{mix indicated}}$ is the measured volume of diluted exhaust gas in the dilution system following extraction of the particulate sample under standard conditions.

4. Determination of PN (if PN measurement is required)

PN shall be calculated using the following equation:

$$PN = \frac{V \times k \times (\overline{C}_s \times \overline{f}_r - C_b \times \overline{f}_{rb}) \times 10^3}{d}$$

where:

- PN is the particle number emission, particles per kilometre;
- V is the volume of the diluted exhaust gas in litres per test (after primary dilution only in the case of double dilution) and corrected to standard conditions (273.15 K (0 °C) and 101.325 kPa);
- k is a calibration factor to correct the PNC measurements to the level of the reference instrument where this is not applied internally within the PNC. Where the calibration factor is applied internally within the PNC, the calibration factor shall be 1;
- \overline{C}_s is the corrected particle number concentration from the diluted exhaust gas expressed as the arithmetic average number of particles per cubic centimetre from the emissions test including the full duration of the drive cycle. If the volumetric mean concentration results \overline{C} from the PNC are not measured at standard conditions (273.15 K (0 °C) and 101.325 kPa), the concentrations shall be corrected to those conditions \overline{C}_s ;
- C_b is either the dilution air or the dilution tunnel background particle number concentration, as permitted by the responsible authority, in particles per cubic centimetre, corrected for coincidence and to standard conditions (273.15 K (0 °C) and 101.325 kPa);
- \overline{f}_r is the mean particle concentration reduction factor of the VPR at the dilution setting used for the test;
- \overline{f}_{rb} is the mean particle concentration reduction factor of the VPR at the dilution setting used for the background measurement;
- d is the distance driven corresponding to the applicable test cycle, km.

\overline{C} shall be calculated using the following equation:

$$\overline{C} = \frac{\sum_{i=1}^n C_i}{n}$$

where:

- C_i is a discrete measurement of particle number concentration in the diluted gas exhaust from the PNC; particles per cm³ and corrected for coincidence;
- n is the total number of discrete particle number concentration measurements made during the applicable test cycle and shall be calculated using the following equation:

$$n = t \times f$$

where:

- t is the time duration of the applicable test cycle, s;
- f is the data logging frequency of the particle counter, Hz.

5. Calculation of cycle energy demand

Unless otherwise specified, the calculation shall be based on the target speed trace given in discrete time sample points.

The total energy demand E for the whole cycle or a specific cycle phase shall be calculated by summing E_i over the corresponding cycle time between $t_{\text{start}} + 1$ and t_{end} according to the following equation:

$$E = \sum_{t_{\text{start}}+1}^{t_{\text{end}}} E_i$$

where:

$$E_i = F_i \times d_i \quad \text{if } F_i > 0$$

$$E_i = 0 \quad \text{if } F_i \leq 0$$

and:

t_{start} is the time at which the applicable test cycle or phase starts (see paragraph 3 of Annex B1), s;

t_{end} is the time at which the applicable test cycle or phase ends (see paragraph 3 of Annex B1), s;

E_i is the energy demand during time period (i-1) to (i), Ws;

F_i is the driving force during time period (i-1) to (i), N;

d_i is the distance travelled during time period (i-1) to (i), m.

$$F_i = f_0 + f_1 \times \left(\frac{v_i + v_{i-1}}{2} \right) + f_2 \times \frac{(v_i + v_{i-1})^2}{4} + (1.03 \times TM) \times a_i$$

where:

F_i is the driving force during time period (i-1) to (i), N;

v_i is the target velocity at time t_i , km/h;

TM is the test mass, kg;

a_i is the acceleration during time period (i-1) to (i), m/s²;

f_0, f_1, f_2 are the road load coefficients for the test vehicle under consideration (TM_L, TM_H or TM_{ind}) in N, N/km/h and in N/(km/h)² respectively.

$$d_i = \frac{(v_i + v_{i-1})}{2 \times 3.6} \times (t_i - t_{i-1})$$

where:

d_i is the distance travelled in time period (i-1) to (i), m;

v_i is the target velocity at time t_i , km/h;

t_i is time, s.

$$a_i = \frac{v_i - v_{i-1}}{3.6 \times (t_i - t_{i-1})}$$

where:

a_i is the acceleration during time period (i-1) to (i), m/s²;

v_i is the target velocity at time t_i , km/h;

t_i is time, s.

6. Calculation of fuel consumption and fuel efficiency (as applicable)
- 6.1. The fuel characteristics required for the calculation of fuel consumption values shall be taken from Annex B3.

- 6.2. For 4-phase WLTP test
- The fuel consumption values shall be calculated from the emissions of hydrocarbons, carbon monoxide, and carbon dioxide using the results of step 6 for criteria emissions and step 7 for CO₂ of Table A7/1.
- For 3-phase WLTP test
- The fuel efficiency values shall be calculated from the emissions of hydrocarbons, carbon monoxide, and carbon dioxide using the results of step 2 for criteria emissions and step 4a for CO₂ of Table A7/1.
- 6.2.1. The general equation in paragraph 6.12. of this annex using H/C and O/C ratios shall be used for the calculation of fuel consumption.
- 6.2.2. For all equations in paragraph 6. of this annex:
- FC is the fuel consumption of a specific fuel, l/100 km (or m³ per 100 km in the case of natural gas or kg/100 km in the case of hydrogen);
- H/C is the hydrogen to carbon ratio of a specific fuel C_xH_yO_z;
- O/C is the oxygen to carbon ratio of a specific fuel C_xH_yO_z;
- MW_C is the molar mass of carbon (12.011 g/mol);
- MW_H is the molar mass of hydrogen (1.008 g/mol);
- MW_O is the molar mass of oxygen (15.999 g/mol);
- ρ_{fuel} is the test fuel density, kg/l. For gaseous fuels, fuel density at 15 °C;
- HC are the emissions of hydrocarbon, g/km;
- CO are the emissions of carbon monoxide, g/km;
- CO₂ are the emissions of carbon dioxide, g/km;
- H₂O are the emissions of water, g/km;
- H₂ are the emissions of hydrogen, g/km;
- p₁ is the gas pressure in the fuel tank before the applicable test cycle, Pa;
- p₂ is the gas pressure in the fuel tank after the applicable test cycle, Pa;
- T₁ is the gas temperature in the fuel tank before the applicable test cycle, K;
- T₂ is the gas temperature in the fuel tank after the applicable test cycle, K;
- Z₁ is the compressibility factor of the gaseous fuel at p₁ and T₁;
- Z₂ is the compressibility factor of the gaseous fuel at p₂ and T₂;
- V is the interior volume of the gaseous fuel tank, m³;
- d is the theoretical length of the applicable phase or cycle, km.
- 6.3. For a vehicle with a positive ignition engine fuelled with petrol (E0)
- $$FC = \left(\frac{0.1155}{\rho_{fuel}} \right) \times [(0.866 \times HC) + (0.429 \times CO) + (0.273 \times CO_2)]$$
- 6.4. [Reserved]
- 6.5. For a vehicle with a positive ignition engine fuelled with petrol (E10)
- $$FC = \left(\frac{0.1206}{\rho_{fuel}} \right) \times [(0.829 \times HC) + (0.429 \times CO) + (0.273 \times CO_2)]$$
- 6.6. For a vehicle with a positive ignition engine fuelled with LPG
- $$FC_{norm} = \left(\frac{0.1212}{0.538} \right) \times [(0.825 \times HC) + (0.429 \times CO) + (0.273 \times CO_2)]$$

- 6.6.1. If the composition of the fuel used for the test differs from the composition that is assumed for the calculation of the normalised consumption, on the manufacturer's request a correction factor cf may be applied, using the following equation:

$$FC_{\text{norm}} = \left(\frac{0.1212}{0.538} \right) \times cf \times [(0.825 \times \text{HC}) + (0.429 \times \text{CO}) + (0.273 \times \text{CO}_2)]$$

The correction factor, cf , which may be applied, is determined using the following equation:

$$cf = 0.825 + 0.0693 \times n_{\text{actual}}$$

where:

n_{actual} is the actual H/C ratio of the fuel used.

- 6.7. For a vehicle with a positive ignition engine fuelled with NG/biomethane

$$FC_{\text{norm}} = \left(\frac{0.1336}{0.654} \right) \times [(0.749 \times \text{HC}) + (0.429 \times \text{CO}) + (0.273 \times \text{CO}_2)]$$

- 6.8. For a vehicle with a compression engine fuelled with diesel (B0)

$$FC = \left(\frac{0.1156}{\rho_{\text{fuel}}} \right) \times [(0.865 \times \text{HC}) + (0.429 \times \text{CO}) + (0.273 \times \text{CO}_2)]$$

- 6.9. [Reserved]

- 6.10. For a vehicle with a compression engine fuelled with diesel (B7)

$$FC = \left(\frac{0.1165}{\rho_{\text{fuel}}} \right) \times [(0.858 \times \text{HC}) + (0.429 \times \text{CO}) + (0.273 \times \text{CO}_2)]$$

- 6.11. For a vehicle with a positive ignition engine fuelled with ethanol (E85)

$$FC = \left(\frac{0.1743}{\rho_{\text{fuel}}} \right) \times [(0.574 \times \text{HC}) + (0.429 \times \text{CO}) + (0.273 \times \text{CO}_2)]$$

- 6.12. Fuel consumption for any test fuel may be calculated using the following equation:

$$FC = \frac{MW_C + \frac{H}{C} \times MW_H + \frac{O}{C} \times MW_O}{MW_C \times \rho_{\text{fuel}} \times 10} \times \left(\frac{MW_C}{MW_C + \frac{H}{C} \times MW_H + \frac{O}{C} \times MW_O} \times \text{HC} + \frac{MW_C}{MW_{\text{CO}}} \times \text{CO} + \frac{MW_C}{MW_{\text{CO}_2}} \times \text{CO}_2 \right)$$

- 6.13. Fuel consumption for a vehicle with a positive ignition engine fuelled by hydrogen:

$$FC = 0.024 \times \frac{V}{d} \times \left(\frac{1}{Z_1} \times \frac{p_1}{T_1} - \frac{1}{Z_2} \times \frac{p_2}{T_2} \right)$$

For vehicles fuelled either with gaseous or liquid hydrogen, and with approval of the responsible authority, the manufacturer may choose to calculate fuel consumption using either the equation for FC below or a method using a standard protocol such as SAE J2572.

$$FC = 0.1 \times (0.1119 \times \text{H}_2\text{O} + \text{H}_2)$$

The compressibility factor, Z , shall be obtained from the following table:

Table A7/2
Compressibility factor **Z**

		p(bar)									
		5	100	200	300	400	500	600	700	800	900
T(K)	33	0.859	1.051	1.885	2.648	3.365	4.051	4.712	5.352	5.973	6.576
	53	0.965	0.922	1.416	1.891	2.338	2.765	3.174	3.570	3.954	4.329
	73	0.989	0.991	1.278	1.604	1.923	2.229	2.525	2.810	3.088	3.358
	93	0.997	1.042	1.233	1.470	1.711	1.947	2.177	2.400	2.617	2.829
	113	1.000	1.066	1.213	1.395	1.586	1.776	1.963	2.146	2.324	2.498
	133	1.002	1.076	1.199	1.347	1.504	1.662	1.819	1.973	2.124	2.271
	153	1.003	1.079	1.187	1.312	1.445	1.580	1.715	1.848	1.979	2.107
	173	1.003	1.079	1.176	1.285	1.401	1.518	1.636	1.753	1.868	1.981
	193	1.003	1.077	1.165	1.263	1.365	1.469	1.574	1.678	1.781	1.882
	213	1.003	1.071	1.147	1.228	1.311	1.396	1.482	1.567	1.652	1.735
	233	1.004	1.071	1.148	1.228	1.312	1.397	1.482	1.568	1.652	1.736
	248	1.003	1.069	1.141	1.217	1.296	1.375	1.455	1.535	1.614	1.693
	263	1.003	1.066	1.136	1.207	1.281	1.356	1.431	1.506	1.581	1.655
	278	1.003	1.064	1.130	1.198	1.268	1.339	1.409	1.480	1.551	1.621
	293	1.003	1.062	1.125	1.190	1.256	1.323	1.390	1.457	1.524	1.590
	308	1.003	1.060	1.120	1.182	1.245	1.308	1.372	1.436	1.499	1.562
	323	1.003	1.057	1.116	1.175	1.235	1.295	1.356	1.417	1.477	1.537
338	1.003	1.055	1.111	1.168	1.225	1.283	1.341	1.399	1.457	1.514	
353	1.003	1.054	1.107	1.162	1.217	1.272	1.327	1.383	1.438	1.493	

In the case that the required input values for p and T are not indicated in the table, the compressibility factor shall be obtained by linear interpolation between the compressibility factors indicated in the table, choosing the ones that are the closest to the value sought.

6.14. Calculation of fuel efficiency (FE)

This paragraph is applicable for the 3-phase WLTP test only:

6.14.1. $FE = 100/FC$

where

FC is the fuel consumption of a specific fuel, l/100 km (or m³ per 100 km in the case of natural gas or kg/100 km in the case of hydrogen);

FE is fuel efficiency; km/l (or km/m³ in the case of natural gas, or km/ kg in the case of hydrogen).

7. Drive trace indices

7.1. General requirement

The prescribed speed between time points in Tables A1/1 to A1/12 shall be determined by linear interpolation at a frequency of 10 Hz.

In the case that the accelerator control is fully activated, the prescribed speed shall be used instead of the actual vehicle speed for drive trace index calculations during such periods of operation.

The on-board diagnostics (OBD) or electronic control unit (ECU) monitoring (data collection) system may be used in order to detect the position of the

accelerator control. The collection of OBD and/or ECU data shall not influence the vehicle's emissions or performance.

7.2. Calculation of drive trace indices

The following indices shall be calculated according to SAE J2951(Revised JAN2014):

- (a) IWR Inertial Work Rating, per cent;
- (b) RMSSE Root Mean Squared Speed Error, km/h.

7.3. [Reserved]

7.4. Vehicle-specific application of drive trace indices

7.4.1. Pure ICE vehicles, NOVC-HEVs, NOVC-FCHVs

The drive trace indices IWR and RMSSE shall be calculated for the applicable test cycle and reported.

7.4.2. OVC-HEVs

7.4.2.1. Charge-sustaining Type 1 test (paragraph 3.2.5. of Annex B8)

The drive trace indices IWR and RMSSE shall be calculated for the applicable test cycle and reported.

7.4.2.2. Charge-depleting Type 1 test (paragraph 3.2.4.3. of Annex B8)

If the number of charge-depleting Type 1 test cycles is less than four, the drive trace indices IWR and RMSSE shall be calculated for each individual applicable test cycle of the charge-depleting Type 1 test and reported

If the number of charge-depleting Type 1 test cycles is greater than or equal to four, the drive trace indices IWR and RMSSE shall be calculated for each individual applicable test cycle of the charge-depleting Type 1 test and reported. In this case, the average IWR and the average RMSSE for the combination of any two cycles within the charge-depleting test shall be compared with the respective criteria specified in paragraph 2.6.8.3.1.3. of Annex B6, and the calculated IWR of any individual cycle within the charge-depleting test shall not be less than -3.0 nor greater than +5.0 per cent.

7.4.2.3. City cycle test (paragraph 3.2.4.3. of Annex B8 replacing WLTC with WLTC_{city})

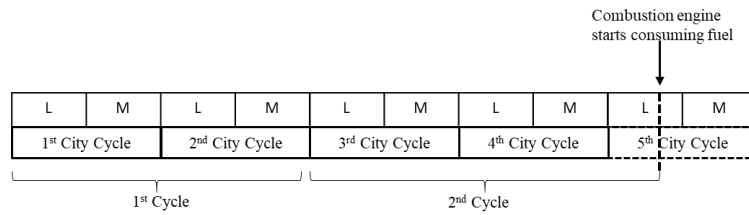
For the application of the drive trace index calculation, two consecutively driven city test cycles (L and M) shall be considered as one cycle.

For the city cycle during which the combustion engine starts to consume fuel, the drive indices IWR and RMSSE shall not be calculated individually. Instead, depending on the number of completed city cycles before the city cycle during which the combustion engine start, the incomplete city cycle shall be combined with the previous city cycles as follows and shall be considered as one cycle in the context of the drive trace index calculations.

If the number of completed city cycles is even, the incomplete city cycle shall be combined with the previous two completed city cycles. See the example in Figure A7/1 below.

Figure A7/1

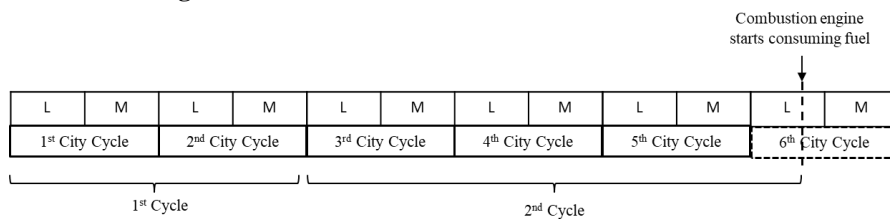
Example with an even number of completed city test cycles before the city cycle where the combustion engine start



If the number of completed city cycles is odd, the incomplete city cycle shall be combined with the previous three completed city cycles. See the example in Figure A7/2 below.

Figure A7/2

Example with an odd number of completed city test cycles before the city cycle where the combustion engine start



If the number of cycles derived according to Figure A7/1 or Figure A7/2 is less than four, the drive trace indices IWR and RMSSE shall be calculated for each individual cycle and reported.

If the number of cycles derived according to Figure A7/1 or Figure A7/2 is greater than or equal to four, the drive trace indices IWR and RMSSE shall be calculated for each individual cycle. In this case, the average IWR and the average RMSSE for the combination of any two cycles shall be compared with the respective criteria specified in paragraph 2.6.8.3.1.3. of Annex B6 and the IWR of any individual cycle shall not be less than -3.0 or greater than +5.0 per cent.

7.4.3. PEV

7.4.3.1. Consecutive cycle test

The consecutive cycle test procedure shall be performed according to paragraph 3.4.4.1. of Annex B8. The drive trace indices IWR and RMSSE shall be calculated for each individual test cycle of the consecutive cycle test procedure and reported. The test cycle during which the break-off criterion is reached, as specified in paragraph 3.4.4.1.3. of Annex B8, shall be combined with the preceding test cycle. The drive trace indices IWR and RMSSE shall be calculated considering this as one cycle.

7.4.3.2. Shortened Type 1 test

The drive trace indices IWR and RMSSE for the shortened Type 1 test procedure, as performed according to paragraph 3.4.4.2. of Annex B8, shall be calculated separately for each dynamic segment 1 and 2 and reported. The calculation of drive trace indices during the constant speed segments shall be omitted.

7.4.3.3. City cycle test procedure (paragraph 3.4.4.1. of Annex B8 replacing WLTC with WLTC_{city})

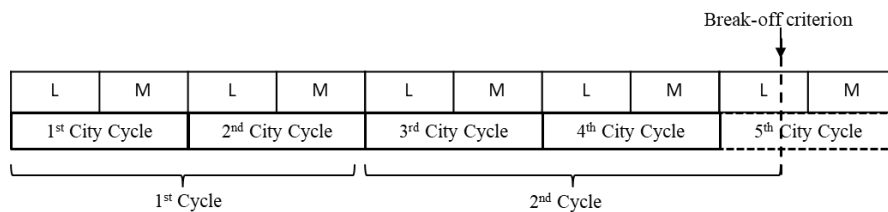
For the application of the drive trace index calculation, two consecutively driven city test cycles shall be considered as one cycle.

For the city cycle during which the break-off criterion is reached as specified in paragraph 3.4.4.1.3. of Annex B8, the drive trace indices IWR and RMSSE shall not be calculated individually. Instead, depending on the number of completed city cycles before the city cycle when the break-off criterion is reached, the incomplete city cycle shall be combined with previous city cycles and shall be considered as one cycle in the context of the drive trace index calculations.

If the number of completed city cycles is even, the incomplete city cycle shall be combined with the previous two completed city cycles. See the example in Figure A7/3 below.

Figure A7/3

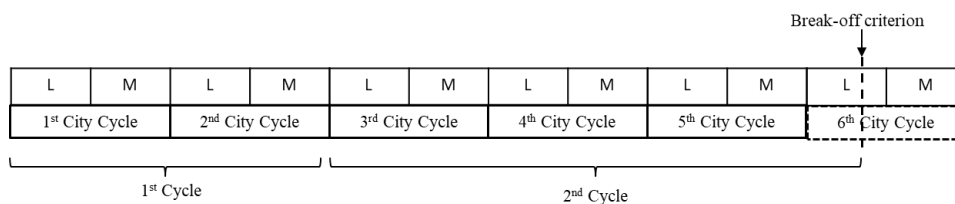
Example with an even number of completed city test cycles before the city cycle with the break-off criterion



If the number of completed city cycles is odd, the incomplete city cycle shall be combined with the previous three completed city cycles. See the example in Figure A7/4 below.

Figure A7/4

Example with an odd number of completed city test cycles before the city cycle with the break-off criterion



If the number of cycles derived according to Figure A7/3 or Figure A7/4 is less than four, the drive trace indices IWR and RMSSE shall be calculated for each of these cycles and reported.

If the number of cycles derived according to Figure A7/3 or Figure A7/4 is greater than or equal to four, the drive trace indices IWR and RMSSE shall be calculated for each of these cycles and reported. In this case, the average IWR and the average RMSSE for the combination of any two cycles shall be compared with the respective criteria as specified in paragraph 2.6.8.3.1. of Annex B6 and the IWR of any individual cycle shall not be less than -3.0 or greater than +5.0 per cent.

8. Calculating n/v ratios

n/v ratios shall be calculated using the following equation:

$$\left(\frac{n}{v}\right)_i = (r_i \times r_{axle} \times 60000)/(U_{dyn} \times 3.6)$$

where:

- n is engine speed, min⁻¹;
- v is the vehicle speed, km/h;
- r_i is the transmission ratio in gear i;
- r_{axle} is the axle transmission ratio.

U_{dyn} is the dynamic rolling circumference of the tyres of the drive axle and is calculated using the following equation:

$$U_{\text{dyn}} = 3.05 \times \left(2 \left(\frac{H/W}{100} \right) \times W + (R \times 25.4) \right)$$

where:

H/W is the tyre's aspect ratio, e.g. "45" for a 225/45 R17 tyre;

W is the tyre width, mm; e.g. "225" for a 225/45 R17 tyre;

R is the wheel diameter, inch; e.g. "17" for a 225/45 R17 tyre.

U_{dyn} shall be rounded according to paragraph 6.1.8. of this Regulation to whole millimetres.

If U_{dyn} is different for the front and the rear axles, the value of n/v for the mainly powered axle shall be applied on a dynamometer in both 2WD and 4WD operation mode.

Upon request, the responsible authority shall be provided with the necessary information for that selection.

Annex B8

Pure electric, hybrid electric and compressed hydrogen fuel cell hybrid vehicles

1. General requirements

In the case of testing NOVC-HEVs, OVC-HEVs and NOVC-FCHVs, Appendix 2 and Appendix 3 to this annex shall replace Appendix 2 to Annex B6.

Unless stated otherwise, all requirements in this annex shall apply to vehicles with and without driver-selectable modes. Unless explicitly stated otherwise in this annex, all of the requirements and procedures specified in Annex B6 and Annex B7 shall continue to apply for NOVC-HEVs, OVC-HEVs, NOVC-FCHVs and PEVs.

1.1. Units, accuracy and resolution of electric parameters

Units, accuracy and resolution of measurements shall be as shown in Table A8/1.

Table A8/1

Parameters, units, accuracy and resolution of measurements

<i>Parameter</i>	<i>Units</i>	<i>Accuracy</i>	<i>Resolution</i>
Electrical energy ^(a)	Wh	±1 per cent	0.001 kWh ^(b)
Electrical current	A	±0.3 per cent FSD or ±1 per cent of reading ^(c,d)	0.1 A
Electric voltage	V	±0.3 per cent FSD or ±1 per cent of reading ^(c)	0.1 V

^(a) Equipment: static meter for active energy.

^(b) AC watt-hour meter, Class 1 according to IEC 62053-21 or equivalent.

^(c) Whichever is greater.

^(d) Current integration frequency 20 Hz or more.

[Table A8/2 Reserved]

1.2. Emission and fuel consumption testing

Parameters, units and accuracy of measurements shall be the same as those required for pure ICE vehicles.

1.3. Rounding of test results

1.3.1. Unless intermediate rounding is required, intermediate steps in the calculations shall not be rounded.

1.3.2. In the case of OVC-HEVs and NOVC-HEVs, the final criteria emission results shall be rounded according to paragraph 1.3.2. of Annex B7, the NOx correction factor KH shall be rounded according to paragraph 1.3.3. of Annex B7, and the dilution factor DF shall be rounded according to paragraph 1.3.4. of Annex B7,

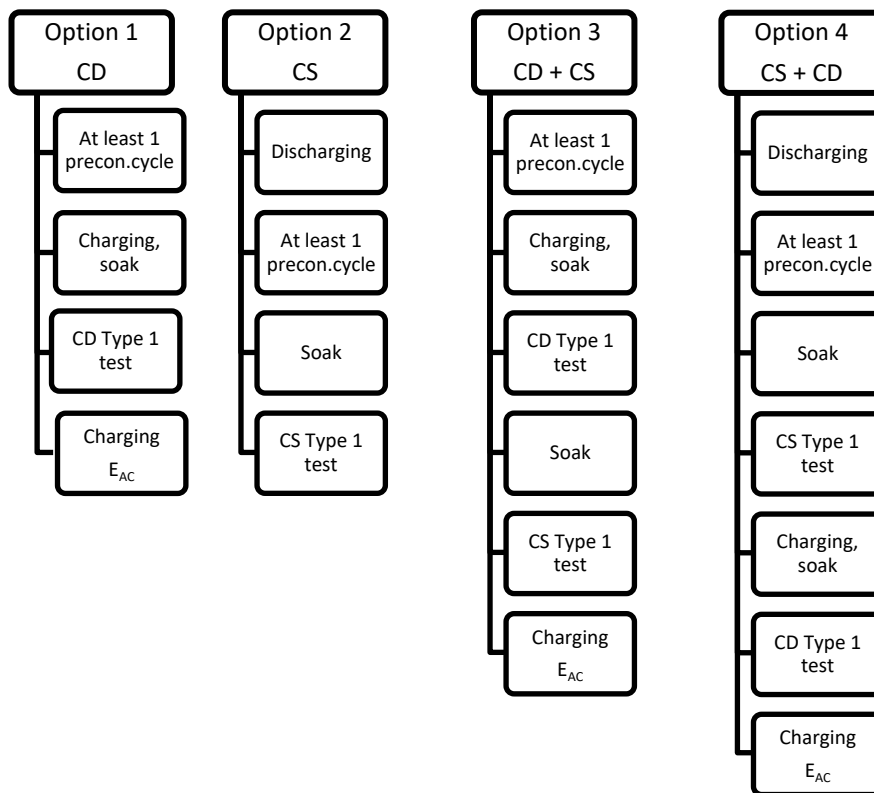
1.3.3. For information not related to standards, good engineering judgement shall be used.

1.3.4. Rounding of range, CO₂, energy consumption and fuel consumption results is described in the calculation tables of this annex.

- 1.4. Vehicle classification
- All OVC-HEVs, NOVC-HEVs, PEVs and NOVC-FCHVs shall be classified as Class 3 vehicles. The applicable test cycle for the Type 1 test procedure shall be determined according to paragraph 1.4.2. of this annex based on the corresponding reference test cycle as described in paragraph 1.4.1. of this annex.
- 1.4.1. Reference test cycle
- 1.4.1.1. The Class 3 reference test cycles are specified in paragraph 3.3. of Annex B1.
- 1.4.1.2. For PEVs, the downscaling procedure, according to paragraphs 8.2.3. and 8.3. of Annex B1, may be applied on the test cycles according to paragraph 3.3. of Annex B1 by replacing the rated power with maximum net power according to UN Regulation No. 85. In such a case, the downscaled cycle is the reference test cycle.
- 1.4.2. Applicable test cycle
- 1.4.2.1. Applicable WLTP test cycle
- The reference test cycle according to paragraph 1.4.1. of this annex shall be the applicable WLTP test cycle (WLTC) for the Type 1 test procedure.
- In the case that paragraph 9. of Annex B1 is applied based on the reference test cycle as described in paragraph 1.4.1. of this annex, this modified test cycle shall be the applicable WLTP test cycle (WLTC) for the Type 1 test procedure.
- 1.4.2.2.
- Applicable WLTP city test cycle
- The Class 3 WLTP city test cycle (WLTC_{city}) is specified in paragraph 3.5. of Annex B1.
- 1.5. OVC-HEVs, NOVC-HEVs, NOVC-FCHVs and PEVs with manual transmissions
- The vehicles shall be driven according to the technical gear shift indicator, if available, or according to instructions incorporated in the manufacturer's handbook.
2. Run-in of test vehicle
- The vehicle tested according to this annex shall be presented in good technical condition and shall be run-in in accordance with the manufacturer's recommendations. In the case that the REESSs are operated above the normal operating temperature range, the operator shall follow the procedure recommended by the vehicle manufacturer in order to keep the temperature of the REESS in its normal operating range. The manufacturer shall provide evidence that the thermal management system of the REESS is neither disabled nor reduced.
- 2.1. OVC-HEVs and NOVC-HEVs shall have been run-in according to the requirements of paragraph 2.3.3. of Annex B6.
- 2.2. NOVC-FCHVs shall have been run-in at least 300 km with their fuel cell and REESS installed.
- 2.3. PEVs shall have been run-in at least 300 km or one full charge distance, whichever is longer.
- 2.4. All REESS having no influence on CO₂ mass emissions or H₂ consumption shall be excluded from monitoring.

3. Test procedure
 - 3.1. General requirements
 - 3.1.1. For all OVC-HEVs, NOVC-HEVs, PEVs and NOVC-FCHVs, the following shall apply where applicable:
 - 3.1.1.1. Vehicles shall be tested according to the applicable test cycles described in paragraph 1.4.2. of this annex.
 - 3.1.1.2. If the vehicle cannot follow the applicable test cycle within the speed trace tolerances according to paragraph 2.6.8.3.1.2. of Annex B6, the accelerator control shall, unless stated otherwise, be fully activated until the required speed trace is reached again.
 - 3.1.1.3. The powertrain start procedure shall be initiated by means of the devices provided for this purpose according to the manufacturer's instructions.
 - 3.1.1.4. For OVC-HEVs, NOVC-HEVs, NOVC-FCHVs and PEVs, exhaust emissions sampling and measurement of electric energy consumption shall begin for each applicable test cycle before or at the initiation of the vehicle start procedure and end at the conclusion of each applicable test cycle.
 - 3.1.1.5. For OVC-HEVs and NOVC-HEVs, gaseous emission compounds, shall be analysed for each individual test phase. It is permitted to omit the phase analysis for phases where no combustion engine operates.
 - 3.1.1.6. If applicable, particle number shall be analysed for each individual phase and particulate matter emission shall be analysed for each applicable test cycle.
 - 3.1.2. Forced cooling as described in paragraph 2.7.2. of Annex B6 shall apply only for the charge-sustaining Type 1 test for OVC-HEVs according to paragraph 3.2. of this annex and for testing NOVC-HEVs according to paragraph 3.3. of this annex.
 - 3.1.3. The requirements of paragraphs 2.2.2.1.2. and 2.2.2.1.3. of Annex B6 are exempted when testing was conducted according to (PEV test procedure) and (FCHV test procedure).
 - 3.2. OVC-HEVs
 - 3.2.1. Vehicles shall be tested under charge-depleting operating condition (CD condition), and charge-sustaining operating condition (CS condition)
 - 3.2.2. Vehicles may be tested according to four possible test sequences:
 - 3.2.2.1. Option 1: charge-depleting Type 1 test with no subsequent charge-sustaining Type 1 test.
 - 3.2.2.2. Option 2: charge-sustaining Type 1 test with no subsequent charge-depleting Type 1 test.
 - 3.2.2.3. Option 3: charge-depleting Type 1 test with a subsequent charge-sustaining Type 1 test.
 - 3.2.2.4. Option 4: charge-sustaining Type 1 test with a subsequent charge-depleting Type 1 test.

Figure A8/1
Possible test sequences in the case of OVC-HEV testing



3.2.3. The driver-selectable mode shall be set as described in the following test sequences (Option 1 to Option 4).

3.2.4. Charge-depleting Type 1 test with no subsequent charge-sustaining Type 1 test (Option 1)

The test sequence according to Option 1, described in paragraphs 3.2.4.1. to 3.2.4.7. inclusive of this annex, as well as the corresponding REESS state of charge profile, are shown in Figure A8.App1/1 in Appendix 1 to this annex.

3.2.4.1. Preconditioning

The vehicle shall be prepared according to the procedures in paragraph 2.2. of Appendix 4 to this annex.

3.2.4.2. Test conditions

3.2.4.2.1. The test shall be carried out with a fully charged REESS according to the charging requirements as described in paragraph 2.2.3. of Appendix 4 to this annex and with the vehicle operated in charge-depleting operating condition as defined in paragraph 3.3.5. of this Regulation.

3.2.4.2.2. Selection of a driver-selectable mode

For vehicles equipped with a driver-selectable mode, the mode for the charge-depleting Type 1 test shall be selected according to paragraph 2. of Appendix 6 to this annex.

3.2.4.3. Charge-depleting Type 1 test procedure

3.2.4.3.1. The charge-depleting Type 1 test procedure shall consist of a number of consecutive cycles, each followed by a soak period of no more than 30 minutes until charge-sustaining operating condition is achieved.

3.2.4.3.2. During soaking between individual applicable test cycles, the powertrain shall be deactivated and the REESS shall not be recharged from an external electric energy source. The instrumentation for measuring the electric

current of all REESSs and for determining the electric voltage of all REESSs according to Appendix 3 of this annex shall not be turned off between test cycle phases. In the case of ampere-hour meter measurement, the integration shall remain active throughout the entire test until the test is concluded.

Restarting after soak, the vehicle shall be operated in the driver-selectable mode according to paragraph 3.2.4.2.2. of this annex.

3.2.4.3.3. In deviation from paragraph 5.3.1. of Annex B5 and additional to paragraph 5.3.1.2. of Annex B5, analysers may be calibrated and zero-checked before and after the charge-depleting Type 1 test.

3.2.4.4. End of the charge-depleting Type 1 test

The end of the charge-depleting Type 1 test is considered to have been reached when the break-off criterion according to paragraph 3.2.4.5. of this annex is reached for the first time. The number of applicable WLTP test cycles up to and including the one where the break-off criterion was reached for the first time is set to n+1.

The applicable WLTP test cycle n is defined as the transition cycle.

The applicable WLTP test cycle n+1 is defined to be the confirmation cycle.

For vehicles without a charge-sustaining capability over the complete applicable WLTP test cycle, the end of the charge-depleting Type 1 test is reached by an indication on a standard on-board instrument panel to stop the vehicle, or when the vehicle deviates from the prescribed speed trace tolerance for 4 consecutive seconds or more. The accelerator control shall be deactivated and the vehicle shall be braked to standstill within 60 seconds.

3.2.4.5. Break-off criterion

3.2.4.5.1. Whether the break-off criterion has been reached for each driven applicable WLTP test cycle shall be evaluated.

3.2.4.5.2. The break-off criterion for the charge-depleting Type 1 test is reached when the relative electric energy change $REEC_i$, as calculated using the following equation, is less than 0.04.

$$REEC_i = \frac{|\Delta E_{REESS,i}|}{E_{cycle} \times \frac{1}{3600}}$$

where:

$REEC_i$ is the relative electric energy change of the applicable test cycle considered i of the charge-depleting Type 1 test;

$\Delta E_{REESS,i}$ is the change of electric energy of all REESSs for the considered charge-depleting Type 1 test cycle i calculated according to paragraph 4.3. of this annex, Wh;

E_{cycle} is the cycle energy demand of the considered applicable WLTP test cycle calculated according to paragraph 5. of Annex B7, Ws;

i is the index number for the considered applicable WLTP test cycle;

$\frac{1}{3600}$ is a conversion factor to Wh for the cycle energy demand.

- 3.2.4.6. REESS charging and measuring the recharged electric energy
- 3.2.4.6.1. The vehicle shall be connected to the mains within 120 minutes after the applicable WLTP test cycle n+1 in which the break-off criterion for the charge-depleting Type 1 test is reached for the first time.
- The REESS is fully charged when the end-of-charge criterion, as defined in paragraph 2.2.3.2. of Appendix 4 to this annex, is reached.
- 3.2.4.6.2. The electric energy measurement equipment, placed between the vehicle charger and the mains, shall measure the recharged electric energy E_{AC} delivered from the mains, as well as its duration. Electric energy measurement may be stopped when the end-of-charge criterion, as defined in paragraph 2.2.3.2. of Appendix 4 to this annex, is reached.
- 3.2.4.7. Each individual applicable WLTP test cycle within the charge-depleting Type 1 test shall fulfil the applicable criteria emission limits according to paragraph 1.2. of Annex B6.
- 3.2.5. Charge-sustaining Type 1 test with no subsequent charge-depleting Type 1 test (Option 2)
- The test sequence according to Option 2, as described in paragraphs 3.2.5.1. to 3.2.5.3.3. inclusive of this annex, as well as the corresponding REESS state of charge profile, are shown in Figure A8.App1/2 in Appendix 1 to this annex.
- 3.2.5.1. Preconditioning and soaking
- The vehicle shall be prepared according to the procedures in paragraph 2.1. of Appendix 4 to this annex.
- 3.2.5.2. Test conditions
- 3.2.5.2.1. Tests shall be carried out with the vehicle operated in charge-sustaining operating condition as defined in paragraph 3.3.6. of this Regulation.
- 3.2.5.2.2. Selection of a driver-selectable mode
- For vehicles equipped with a driver-selectable mode, the mode for the charge-sustaining Type 1 test shall be selected according to paragraph 3. of Appendix 6 to this annex.
- 3.2.5.3. Type 1 test procedure
- 3.2.5.3.1. Vehicles shall be tested according to the Type 1 test procedures described in Annex B6.
- 3.2.5.3.2. If required, CO₂ mass emission shall be corrected according to Appendix 2 to this annex.
- 3.2.5.3.3. The test according to paragraph 3.2.5.3.1. of this annex shall fulfil the applicable criteria emission limits according to paragraph 1.2. of Annex B6.
- 3.2.6. Charge-depleting Type 1 test with a subsequent charge-sustaining Type 1 test (Option 3)
- The test sequence according to Option 3, as described in paragraphs 3.2.6.1. to 3.2.6.3. inclusive of this annex, as well as the corresponding REESS state of charge profile, are shown in Figure A8.App1/3 in Appendix 1 to this annex.
- 3.2.6.1. For the charge-depleting Type 1 test, the procedure described in paragraphs 3.2.4.1. to 3.2.4.5. inclusive as well as paragraph 3.2.4.7. of this annex shall be followed.
- 3.2.6.2. Subsequently, the procedure for the charge-sustaining Type 1 test described in paragraphs 3.2.5.1. to 3.2.5.3. inclusive of this annex shall be followed. Paragraphs 2.1.1. and 2.1.2. of Appendix 4 to this annex shall not apply.

- 3.2.6.3. REESS charging and measuring the recharged electric energy
- 3.2.6.3.1. The vehicle shall be connected to the mains within 120 minutes after the conclusion of the charge-sustaining Type 1 test.
The REESS is fully charged when the end-of-charge criterion as defined in paragraph 2.2.3.2. of Appendix 4 to this annex is reached.
- 3.2.6.3.2. The energy measurement equipment, placed between the vehicle charger and the mains, shall measure the recharged electric energy E_{AC} delivered from the mains, as well as its duration. Electric energy measurement may be stopped when the end-of-charge criterion as defined in paragraph 2.2.3.2. of Appendix 4 to this annex is reached.
- 3.2.7. Charge-sustaining Type 1 test with a subsequent charge-depleting Type 1 test (Option 4)
The test sequence according to Option 4, described in paragraphs 3.2.7.1. and 3.2.7.2. of this annex, as well as the corresponding REESS state of charge profile, are shown in Figure A8.App1/4 of Appendix 1 to this annex.
- 3.2.7.1. For the charge-sustaining Type 1 test, the procedure described in paragraphs 3.2.5.1. to 3.2.5.3. inclusive of this annex, as well as paragraph 3.2.6.3.1. of this annex, shall be followed.
- 3.2.7.2. Subsequently, the procedure for the charge-depleting Type 1 test described in paragraphs 3.2.4.2. to 3.2.4.7. inclusive of this annex shall be followed.
- 3.3. NOVC-HEVs
The test sequence described in paragraphs 3.3.1. to 3.3.3. inclusive of this annex, as well as the corresponding REESS state of charge profile, are shown in Figure A8.App1/5 of Appendix 1 to this annex.
- 3.3.1. Preconditioning and soaking
- 3.3.1.1. Vehicles shall be preconditioned according to paragraph 2.6. of Annex B6.
In addition to the requirements of paragraph 2.6. of Annex B6, the level of the state of charge of the traction REESS for the charge-sustaining test may be set according to the manufacturer's recommendation before preconditioning in order to achieve a test under charge-sustaining operating condition.
- 3.3.1.2. Vehicles shall be soaked according to paragraph 2.7. of Annex B6.
- 3.3.2. Test conditions
- 3.3.2.1. Vehicles shall be tested under charge-sustaining operating condition as defined in paragraph 3.3.6. of this Regulation.
- 3.3.2.2. Selection of a driver-selectable mode
For vehicles equipped with a driver-selectable mode, the mode for the charge-sustaining Type 1 test shall be selected according to paragraph 3. of Appendix 6 to this annex.
- 3.3.3. Type 1 test procedure
- 3.3.3.1. Vehicles shall be tested according to the Type 1 test procedure described in Annex B6.
- 3.3.3.2. If required, the CO₂ mass emission shall be corrected according to Appendix 2 to this annex.
- 3.3.3.3. The charge-sustaining Type 1 test shall fulfil the applicable criteria emission limits according to paragraph 1.2. of Annex B6.

- 3.4. PEVs
3.4.1. General requirements

The test procedure to determine the pure electric range and electric energy consumption shall be selected according to the estimated pure electric range (PER) of the test vehicle from Table A8/3. In the case that the interpolation method is applied, the applicable test procedure shall be selected according to the PER of vehicle H within the specific interpolation family.

Table A8/3
Procedures to determine pure electric range and electric energy consumption (as applicable)

<i>Applicable test cycle</i>	<i>The estimated PER is...</i>	<i>Applicable test procedure</i>
Test cycle according to paragraph 1.4.2.1. of this annex including the extra high phase.	...less than the length of 3 applicable WLTP test cycles.	Consecutive cycle Type 1 test procedure (according to paragraph 3.4.4.1. of this annex).
	... equal to or greater than the length of 3 applicable WLTP test cycles.	Shortened Type 1 test procedure (according to paragraph 3.4.4.2. of this annex).
Test cycle according to paragraph 1.4.2.1. of this annex excluding the extra high phase.	...less than the length of 4 applicable WLTP test cycles.	Consecutive cycle Type 1 test procedure (according to paragraph 3.4.4.1. of this annex).
	...equal to or greater than the length of 4 applicable WLTP test cycles.	Shortened Type 1 test procedure (according to paragraph 3.4.4.2. of this annex).
City cycle according to paragraph 1.4.2.2. of this annex.	...not available over the applicable WLTP test cycle.	Consecutive cycle Type 1 test procedure (according to paragraph 3.4.4.1. of this annex).

The manufacturer shall give evidence to the responsible authority concerning the estimated pure electric range (PER) prior to the test. In the case that the interpolation method is applied, the applicable test procedure shall be determined based on the estimated PER of vehicle H of the interpolation family. The PER determined by the applied test procedure shall confirm that the correct test procedure was applied.

The test sequence for the consecutive cycle Type 1 test procedure, as described in paragraphs 3.4.2., 3.4.3. and 3.4.4.1. of this annex, as well as the corresponding REESS state of charge profile, are shown in Figure A8.App1/6 of Appendix 1 to this annex.

The test sequence for the shortened Type 1 test procedure, as described in paragraphs 3.4.2., 3.4.3. and 3.4.4.2. of this annex as well as the corresponding REESS state of charge profile, are shown in Figure A8.App1/7 in Appendix 1 to this annex.

- 3.4.2. Preconditioning

The vehicle shall be prepared according to the procedures in paragraph 3. of Appendix 4 to this annex.

3.4.3. Selection of a driver-selectable mode

For vehicles equipped with a driver-selectable mode, the mode for the test shall be selected according to paragraph 4. of Appendix 6 to this annex.

3.4.4. PEV Type 1 test procedures

3.4.4.1. Consecutive cycle Type 1 test procedure

3.4.4.1.1. Speed trace and breaks

The test shall be performed by driving consecutive applicable test cycles until the break-off criterion according to paragraph 3.4.4.1.3. of this annex is reached.

Breaks for the driver and/or operator are permitted only between test cycles and with a maximum total break time of 10 minutes. During the break, the powertrain shall be switched off.

3.4.4.1.2. REESS current and voltage measurement

From the beginning of the test until the break-off criterion is reached, the electric current of all REESSs shall be measured according to Appendix 3 to this annex and the electric voltage shall be determined according to Appendix 3 to this annex.

3.4.4.1.3. Break-off criterion

The break-off criterion is reached when the vehicle exceeds the prescribed speed trace tolerance as specified in paragraph 2.6.8.3.1.2. of Annex B6 for 4 consecutive seconds or more. The accelerator control shall be deactivated. The vehicle shall be braked to standstill within 60 seconds.

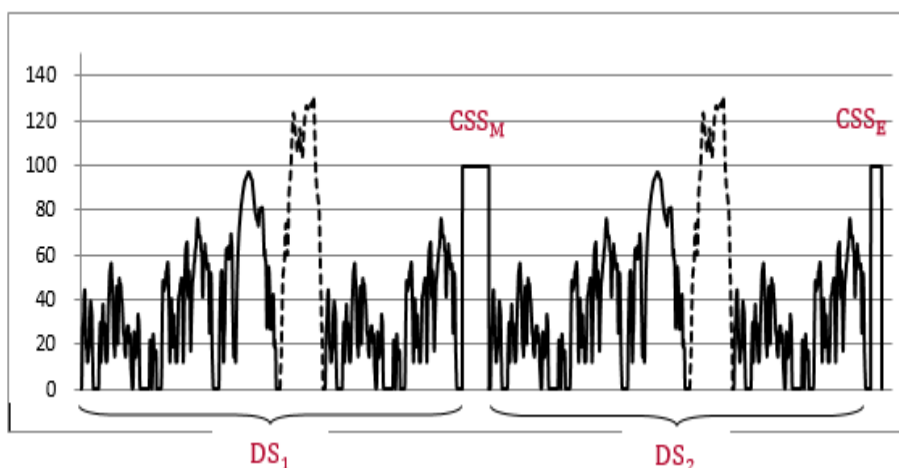
3.4.4.2. Shortened Type 1 test procedure

3.4.4.2.1. Speed trace

The shortened Type 1 test procedure consists of two dynamic segments (DS_1 and DS_2) combined with two constant speed segments (CSS_M and CSS_E) as shown in Figure A8/2.

Figure A8/2

Shortened Type 1 test procedure speed trace



The dynamic segments DS_1 and DS_2 are used to calculate the energy consumption of the phase considered, the applicable WLTP city cycle and the applicable WLTP test cycle.

The constant speed segments CSS_M and CSS_E are intended to reduce test duration by depleting the REESS more rapidly than the consecutive cycle Type 1 test procedure.

3.4.4.2.1.1. Dynamic segments

Each dynamic segment DS_1 and DS_2 consists of an applicable WLTP test cycle according to paragraph 1.4.2.1. of this annex followed by an applicable WLTP city test cycle according to paragraph 1.4.2.2. of this annex.

3.4.4.2.1.2. Constant speed segment

The constant speeds during segments CSS_M and CSS_E shall be identical. If the interpolation method is applied, the same constant speed shall be applied within the interpolation family.

(a) Speed specification

The minimum speed of the constant speed segments shall be 100 km/h. If the extra high phase (Extra High₃) is excluded (as applicable), the minimum speed of the constant speed segments shall be set to 80 km/h. At the request of manufacturer and with approval of the responsible authority, a higher constant speed in the constant speed segments may be selected.

The acceleration to the constant speed level shall be smooth and accomplished within 1 minute after completion of the dynamic segments and, in the case of a break according to Table A8/4, after initiating the powertrain start procedure.

The deceleration from the constant speed level shall be smooth and accomplished within 1 minute after completion of the constant speed segments.

If the maximum speed of the vehicle is lower than the required minimum speed for the constant speed segments according to the speed specification of this paragraph, the required speed in the constant speed segments shall be equal to the maximum speed of the vehicle.

(b) Distance determination of CSS_E and CSS_M

The length of the constant speed segment CSS_E shall be determined based on the percentage of the usable REESS energy UBE_{STP} according to paragraph 4.4.2.1. of this annex. The remaining energy in the traction REESS after dynamic speed segment DS_2 shall be equal to or less than 10 per cent of UBE_{STP} . The manufacturer shall provide evidence to the responsible authority after the test that this requirement is fulfilled.

The length d_{CSSM} of constant speed segment CSS_M may be calculated using the following equation:

$$d_{CSSM} = PER_{est} - d_{DS1} - d_{DS2} - d_{CSSE}$$

where:

d_{CSSM} is the length of constant speed segment CSS_M , km;

PER_{est} is the estimated pure electric range of the considered PEV, km;

d_{DS1} is the length of dynamic speed segment 1, km;

d_{DS2} is the length of dynamic speed segment 2, km;

d_{CSSE} is the length of constant speed segment CSS_E , km.

3.4.4.2.1.3. Breaks

Breaks for the driver and/or operator are permitted only in the constant speed segments as prescribed in Table A8/4.

Table A8/4

Breaks for the driver and/or test operator

<i>Distance driven in constant speed segment CSS_M (km)</i>	<i>Maximum total break (min)</i>
Up to 100	10
Up to 150	20
Up to 200	30
Up to 300	60
More than 300	Shall be based on the manufacturer's recommendation

Note: During a break, the powertrain shall be switched off.

3.4.4.2.2. REESS current and voltage measurement

From the beginning of the test until the break-off criterion is reached, the electric current of all REESSs and the electric voltage of all REESSs shall be determined according to Appendix 3 to this annex.

3.4.4.2.3. Break-off criterion

The break-off criterion is reached when the vehicle exceeds the prescribed speed trace tolerance as specified in paragraph 2.6.8.3.1.2. of Annex B6 for 4 consecutive seconds or more in the second constant speed segment CSS_E . The accelerator control shall be deactivated. The vehicle shall be braked to a standstill within 60 seconds.

3.4.4.3. REESS charging and measuring the recharged electric energy

3.4.4.3.1. After coming to a standstill according to paragraph 3.4.4.1.3. of this annex for the consecutive cycle Type 1 test procedure and in paragraph 3.4.4.2.3. of this annex for the shortened Type 1 test procedure, the vehicle shall be connected to the mains within 120 minutes.

The REESS is fully charged when the end-of-charge criterion, as defined in paragraph 2.2.3.2. of Appendix 4 to this annex, is reached.

3.4.4.3.2. The energy measurement equipment, placed between the vehicle charger and the mains, shall measure the recharged electric energy E_{AC} delivered from the mains as well as its duration. Electric energy measurement may be stopped when the end-of-charge criterion, as defined in paragraph 2.2.3.2. of Appendix 4 to this annex, is reached.

3.5. NOVC-FCHVs

The test sequence, described in paragraphs 3.5.1. to 3.5.3. inclusive of this annex, as well as the corresponding REESS state of charge profile, is shown in Figure A8.App1/5 in Appendix 1 to this annex.

3.5.1. Preconditioning and soaking

Vehicles shall be conditioned and soaked according to paragraph 3.3.1. of this annex.

3.5.2. Test conditions

3.5.2.1. Vehicles shall be tested under charge-sustaining operating conditions as defined in paragraph 3.3.6. of this Regulation.

3.5.2.2. Selection of a driver-selectable mode

For vehicles equipped with a driver-selectable mode, the mode for the charge-sustaining Type 1 test shall be selected according to paragraph 3. of Appendix 6 to this annex.

- 3.5.3. Type 1 test procedure
 - 3.5.3.1. Vehicles shall be tested according to the Type 1 test procedure described in Annex B6 and fuel consumption calculated according to Appendix 7 to this annex.
 - 3.5.3.2. If required, fuel consumption shall be corrected according to Appendix 2 to this annex.
- 4. Calculations for hybrid electric, pure electric and compressed hydrogen fuel cell vehicles
 - 4.1. Calculations of gaseous emission compounds, particulate matter emission and particle number emission
 - 4.1.1. Charge-sustaining mass emission of gaseous emission compounds, particulate matter emission and particle number emission for OVC-HEVs and NOVC-HEVs

The charge-sustaining particulate matter emission PM_{CS} shall be calculated according to paragraph 3.3. of Annex B7.

The charge-sustaining particle number emission PN_{CS} shall be calculated according to paragraph 4. of Annex B7.
 - 4.1.1.1. Stepwise procedure for calculating the final test results of the charge-sustaining Type 1 test for NOVC-HEVs and OVC-HEVs

The results shall be calculated in the order described in Table A8/5. All applicable results in the column "Output" shall be recorded. The column "Process" describes the paragraphs to be used for calculation or contains additional calculations.

For the purpose of this table, the following nomenclature within the equations and results is used:

 - c complete applicable test cycle (to be calculated both for results after 3-phases and for results after 4-phases);
 - p every applicable cycle phase, for the purpose of $EAER_{city}$ calculation (as applicable), p shall represent the city driving cycle;
 - i applicable criteria emission component (except CO_2);
 - CS charge-sustaining;
 - CO_2 CO_2 mass emission.

Table A8/5
Calculation of final charge-sustaining gaseous emission and fuel efficiency values (FE applicable for results after 3 phases only)

Step No.	Source	Input	Process	Output
1	Annex B6	Raw test results	Charge-sustaining mass emissions Paragraphs 3. to 3.2.2. inclusive of Annex B7.	$M_{i,CS,p,1}$, g/km; $M_{CO_2,CS,p,1}$, g/km.
2	Output step 1	$M_{i,CS,p,1}$, g/km; $M_{CO_2,CS,p,1}$, g/km.	Calculation of combined charge-sustaining cycle values: $M_{i,CS,c,2} = \frac{\sum_p M_{i,CS,p,1} \times d_p}{\sum_p d_p}$ $M_{CO_2,CS,c,2} = \frac{\sum_p M_{CO_2,CS,p,1} \times d_p}{\sum_p d_p}$	$M_{i,CS,c,2}$, g/km; $M_{CO_2,CS,c,2}$, g/km.

Step No.	Source	Input	Process	Output
			<p>where:</p> <p>$M_{i,CS,c,2}$ is the charge-sustaining mass emission result over the total cycle;</p> <p>$M_{CO_2,CS,c,2}$ is the charge-sustaining CO₂ mass emission result over the total cycle;</p> <p>d_p are the driven distances of the cycle phases p.</p>	
3	Output step 1 Output step 2	$M_{CO_2,CS,p,1}$, g/km; $M_{CO_2,CS,c,2}$, g/km.	REESS electric energy change correction Paragraphs 4.1.1.2. to 4.1.1.5. inclusive of this annex.	$M_{CO_2,CS,p,3}$, g/km; $M_{CO_2,CS,c,3}$, g/km.
4a	Output step 2 Output step 3	$M_{i,CS,c,2}$, g/km; $M_{CO_2,CS,c,3}$, g/km.	<p>Charge-sustaining mass emission correction for all vehicles equipped with periodically regenerating systems K_i according to Annex B6, Appendix 1.</p> $M_{i,CS,c,4} = K_i \times M_{i,CS,c,2}$ <p>or</p> $M_{i,CS,c,4} = K_i + M_{i,CS,c,2}$ <p>and</p> $M_{CO_2,CS,c,4} = K_{CO_2,K_i} \times M_{CO_2,CS,c,3}$ <p>or</p> $M_{CO_2,CS,c,4} = K_{CO_2,K_i} + M_{CO_2,CS,c,3}$ <p>Additive offset or multiplicative factor to be used according to K_i determination.</p> <p>If K_i is not applicable:</p> $M_{i,CS,c,4} = M_{i,CS,c,2}$ $M_{CO_2,CS,c,4} = M_{CO_2,CS,c,3}$	$M_{i,CS,c,4a}$, g/km; $M_{CO_2,CS,c,4a}$, g/km.
4b	Output step 3 Output step 4a	$M_{CO_2,CS,p,3}$, g/km; $M_{CO_2,CS,c,3}$, g/km; $M_{CO_2,CS,c,4a}$, g/km.	<p>If K_i is applicable, align CO₂ phase values to combined cycle value:</p> $M_{CO_2,CS,p,4} = M_{CO_2,CS,p,3} \times AF_{K_i}$ <p>for every cycle phase p;</p> <p>where:</p> $AF_{K_i} = \frac{M_{CO_2,CS,c,4}}{M_{CO_2,CS,c,3}}$ <p>If K_i is not applicable:</p> $M_{CO_2,CS,p,4} = M_{CO_2,CS,p,3}$	$M_{CO_2,CS,p,4}$, g/km.
4c	For results after 4 phases Output step 4a	$M_{i,CS,c,4a}$, g/km; $M_{CO_2,CS,c,4a}$, g/km.	In the case these values are used for the purpose of conformity of production, the criteria emission values and CO ₂ mass emission values shall be multiplied with the	$M_{i,CS,c,4c}$; $M_{CO_2,CS,c,4c}$

Step No.	Source	Input	Process	Output
			<p>run-in factor RI determined according to paragraph 8.2.4 of this Regulation:</p> $M_{i,CS,c,4c} = RI_C(j) \times M_{i,CS,c,4a}$ $M_{CO_2,CS,c,4c} = RI_{CO_2}(j) \times M_{CO_2,CS,c,4a}$ <p>In the case these values are not used for the purpose of conformity of production:</p> $M_{i,c,4c} = M_{i,c,4a}$ $M_{CO_2,c,4c} = M_{CO_2,c,4a}$	
	For results after 3 phases Output step 4a	$M_{i,c,4a}$, g/km; $M_{CO_2,c,4a}$, g/km.	<p>Calculate fuel efficiency ($FE_{c,4c_temp}$) according to paragraph 6.14.1. of Annex B6.</p> $FE_{c,4c} = RI_{FE}(j) \times FE_{c,4c_temp}$ <p>In the case these values are not used for the purpose of conformity of production:</p> $FE_{c,4c} = FE_{c,4c_temp}$	$FE_{c,4c}$, km/l;
5 Result of a single test.	For results after 4 phases only Output step 4b and 4c	$M_{CO_2,CS,p,4}$, g/km; $M_{CO_2,CS,c,4c}$, g/km;	ATCT correction in accordance with paragraph 3.8.2. of Annex 6a.	$M_{CO_2,CS,c,5}$, g/km; $M_{CO_2,CS,p,5}$, g/km.
	Output step 4b and 4c	$M_{i,CS,c,4c}$, g/km; $FE_{c,4c}$, km/l;	<p>Apply deterioration factors calculated in accordance with Annex C4 to the criteria emissions values.</p> <p>In the case these values are used for the purpose of conformity of production, the further steps (6 to 9) are not required and the output of this step is the final result.</p>	$M_{i,CS,c,5}$, g/km; $FE_{c,5}$, km/l;
6 $M_{i,CS}$ results of a Type 1 test for a test vehicle.	For results after 4 phases Output step 5	For every test: $M_{i,CS,c,5}$, g/km; $M_{CO_2,CS,c,5}$, g/km; $M_{CO_2,CS,p,5}$, g/km.	Averaging of tests and declared value according to paragraphs 1.2. to 1.2.3. inclusive of Annex B6.	$M_{i,CS,c,6}$, g/km; $M_{CO_2,CS,c,6}$, g/km; $M_{CO_2,CS,p,6}$, g/km; $M_{CO_2,CS,c,declared}$, g/km.
	For results after 3 phases Output step 5	$FE_{c,5}$, km/l;	<p>Averaging of tests and declared value.</p> <p>Paragraphs 1.2. to 1.2.3. inclusive of Annex B6.</p> <p>The conversion from $FE_{c,declared}$ to $M_{CO_2,c,declared}$, shall be performed for the applicable cycle. For that purpose, the criteria emission over the complete cycle shall be used.</p>	$FE_{c,declared}$, km/l $M_{CO_2,c,declared}$, g/km.

Step No.	Source	Input	Process	Output
7 $M_{CO_2,CS}$ results of a Type 1 test for a test vehicle.	Output step 6	$M_{CO_2,CS,c,6}$, g/km; $M_{CO_2,CS,p,6}$, g/km; $M_{CO_2,CS,c,declared}$, g/km.	Alignment of phase values. Paragraph 1.2.4. of Annex B6, and: $M_{CO_2,CS,c,7} = M_{CO_2,CS,c,declared}$	$M_{CO_2,CS,c,7}$, g/km; $M_{CO_2,CS,p,7}$, g/km.
For results after 4 phases only 8 Interpo- lation family result. Final criteria emission result. If the interpolation method is not applied, step No. 9 is not required and the output of this step is the final CO_2 result.	Output step 6 Output step 7	For each of the test vehicles H and L and, if applicable, vehicle M: $M_{i,CS,c,6}$, g/km; For each of the test vehicles H and L and, if applicable, vehicle M: $M_{CO_2,CS,c,7}$, g/km; $M_{CO_2,CS,p,7}$, g/km.	If in addition to a test vehicle H a test vehicle L and, if applicable vehicle M was also tested, the resulting criteria emission value shall be the highest of the two or, if applicable, three values and referred to as $M_{i,CS,c}$ In the case of the combined THC+ NO_x emissions, the highest value of the sum referring to either the vehicle H or vehicle L or, if applicable, vehicle M is to be declared. Otherwise, if no vehicle L or if applicable vehicle M was tested, $M_{i,CS,c} = M_{i,CS,c,6}$ In the case that the interpolation method is applied, intermediate rounding shall be applied according to paragraph 6.1.8. of this Regulation: CO_2 values derived in step 7 of this table shall be rounded to two places of decimal. Also, the output for CO_2 is available for vehicles H and vehicle L and, if applicable, for vehicle M. In the case that the interpolation method is not applied, final rounding shall be applied according to paragraph 6.1.8. of this Regulation: CO_2 values derived in step 7 of this table shall be rounded to the nearest whole number.	$M_{i,CS,c}$, g/km; $M_{CO_2,CS,c}$, g/km; $M_{CO_2,CS,p}$, g/km;
For results after 4 phases only 9 Result of an individual vehicle.	Output step 8	$M_{CO_2,CS,c}$, g/km; $M_{CO_2,CS,p}$, g/km;	CO_2 mass emission calculation according to paragraph 4.5.4.1. of this annex for individual vehicles in an interpolation family. Final rounding of individual vehicle CO_2 values shall be performed according to paragraph 6.1.8. of this Regulation.	$M_{CO_2,CS,c,ind}$, g/km; $M_{CO_2,CS,p,ind}$, g/km.

Step No.	Source	Input	Process	Output
Final CO ₂ result.			CO ₂ values shall be rounded to the nearest whole number. Output is available for each individual vehicle.	

- 4.1.1.2. In the case that the correction according to paragraph 1.1.4. of Appendix 2 to this annex was not applied, the following charge-sustaining CO₂ mass emission shall be used:

$$M_{CO_2,CS} = M_{CO_2,CS,nb}$$

where:

$M_{CO_2,CS}$ is the charge-sustaining CO₂ mass emission of the charge-sustaining Type 1 test according to Table A8/5, step No. 3, g/km;

$M_{CO_2,CS,nb}$ is the non-balanced charge-sustaining CO₂ mass emission of the charge-sustaining Type 1 test, not corrected for the energy balance, determined according to Table A8/5, step No. 2, g/km.

- 4.1.1.3. If the correction of the charge-sustaining CO₂ mass emission is required according to paragraph 1.1.3. of Appendix 2 to this annex or in the case that the correction according to paragraph 1.1.4. of Appendix 2 to this annex was applied, the CO₂ mass emission correction coefficient shall be determined according to paragraph 2. of Appendix 2 to this annex. The corrected charge-sustaining CO₂ mass emission shall be determined using the following equation:

$$M_{CO_2,CS} = M_{CO_2,CS,nb} - K_{CO_2} \times EC_{DC,CS}$$

where:

$M_{CO_2,CS}$ is the charge-sustaining CO₂ mass emission of the charge-sustaining Type 1 test according to Table A8/5, step No. 3, g/km;

$M_{CO_2,CS,nb}$ is the non-balanced CO₂ mass emission of the charge-sustaining Type 1 test, not corrected for the energy balance, determined according to Table A8/5, step No. 2, g/km;

$EC_{DC,CS}$ is the electric energy consumption of the charge-sustaining Type 1 test according to paragraph 4.3. of this annex, Wh/km;

K_{CO_2} is the CO₂ mass emission correction coefficient according to paragraph 2.3.2. of Appendix 2 to this annex, (g/km)/(Wh/km).

- 4.1.1.4. In the case that phase-specific CO₂ mass emission correction coefficients have not been determined, the phase-specific CO₂ mass emission shall be calculated using the following equation:

$$M_{CO_2,CS,p} = M_{CO_2,CS,nb,p} - K_{CO_2} \times EC_{DC,CS,p}$$

where:

$M_{CO_2,CS,p}$ is the charge-sustaining CO₂ mass emission of phase p of the charge-sustaining Type 1 test according to Table A8/5, step No. 3, g/km;

$M_{CO_2,CS,nb,p}$ is the non-balanced CO₂ mass emission of phase p of the charge-sustaining Type 1 test, not corrected for the energy balance, determined according to Table A8/5, step No. 1, g/km;

$EC_{DC,CS,p}$ is the electric energy consumption of phase p of the charge-sustaining Type 1 test according to paragraph 4.3. of this annex, Wh/km;

K_{CO_2} is the CO₂ mass emission correction coefficient according to paragraph 2.3.2. of Appendix 2 to this annex, (g/km)/(Wh/km).

4.1.1.5. In the case that phase-specific CO₂ mass emission correction coefficients have been determined, the phase-specific CO₂ mass emission shall be calculated using the following equation:

$$M_{CO_2,CS,p} = M_{CO_2,CS,nb,p} - K_{CO_2,p} \times EC_{DC,CS,p}$$

where:

$M_{CO_2,CS,p}$ is the charge-sustaining CO₂ mass emission of phase p of the charge-sustaining Type 1 test according to Table A8/5, step No. 3, g/km;

$M_{CO_2,CS,nb,p}$ is the non-balanced CO₂ mass emission of phase p of the charge-sustaining Type 1 test, not corrected for the energy balance, determined according to Table A8/5, step No. 1, g/km;

$EC_{DC,CS,p}$ is the electric energy consumption of phase p of the charge-sustaining Type 1 test, determined according to paragraph 4.3. of this annex, Wh/km;

$K_{CO_2,p}$ is the CO₂ mass emission correction coefficient according to paragraph 2.3.2.2. of Appendix 2 to this annex, (g/km)/(Wh/km);

p is the index of the individual phase within the applicable WLTP test cycle.

4.1.2. Charge-depleting CO₂ mass emission for OVC-HEVs

For 4-phase WLTP test

The utility factor-weighted charge-depleting CO₂ mass emission $M_{CO_2,CD}$ shall be calculated using the following equation:

$$M_{CO_2,CD} = \frac{\sum_{j=1}^k (UF_j \times M_{CO_2,CD,j})}{\sum_{j=1}^k UF_j}$$

For 3-phase WLTP test

The charge-depleting CO₂ mass emission $M_{CO_2,CD}$ shall be calculated using the following equation:

$$M_{CO_2,CD} = \frac{\sum_{j=1}^k (M_{CO_2,CD,j} \times d_j)}{\sum_{j=1}^k d_j}$$

where:

$M_{CO_2,CD}$ is the utility factor-weighted charge-depleting CO₂ mass emission, g/km;

$M_{CO_2,CD,j}$ is the CO₂ mass emission determined according to paragraph 3.2.1. of Annex B7 of phase j of the charge-depleting Type 1 test, g/km;

UF_j is the utility factor of phase j according to Appendix 5 to this annex;

j is the index number of the considered phase;

k is the number of phases driven up to the end of the transition cycle according to paragraph 3.2.4.4. of this annex.

In the case that the interpolation method is applied, k shall be the number of phases driven up to the end of the transition cycle of vehicle L , n_{veh_L} .

If the transition cycle number driven by vehicle H , n_{veh_H} , and, if applicable, by an individual vehicle within the vehicle interpolation family, n_{veh_ind} , is lower than the transition cycle number driven by vehicle L , n_{veh_L} , the confirmation cycle of vehicle H and, if applicable, an individual vehicle shall be included in the calculation. The CO₂ mass emission of each phase of the confirmation cycle shall be subsequently corrected to an electric energy consumption of zero ($EC_{DC,CD,j} = 0$) by using the CO₂ correction coefficient according to Appendix 2 to this annex.

4.1.3. This paragraph is applicable for 4-phase WLTP test only:

Utility factor-weighted mass emissions of gaseous compounds, particulate matter emission and particle number emission for OVC-HEVs

4.1.3.1. The utility factor-weighted mass emission of gaseous compounds

$$M_{i,weighted} = \sum_{j=1}^k (UF_j \times M_{i,CD,j}) + (1 - \sum_{j=1}^k UF_j) \times M_{i,CS}$$

where:

- $M_{i,weighted}$ is the utility factor-weighted mass emission compound i , g/km;
- i is the index of the considered gaseous emission compound (except CO₂);
- UF_j is the utility factor of phase j according to Appendix 5 to this annex;
- $M_{i,CD,j}$ is the mass emission of the gaseous emission compound i determined according to paragraph 3.2.1. of Annex B7 of phase j of the charge-depleting Type 1 test, g/km;
- $M_{i,CS}$ is the charge-sustaining mass emission of gaseous emission compound i for the charge-sustaining Type 1 test according to Table A8/5, step No. 6, g/km;
- j is the index number of the considered phase;
- k is the number of phases driven until the end of the transition cycle according to paragraph 3.2.4.4. of this annex.

For calculating the utility-factor weighted CO₂ mass emission the following equation shall be used:

$$M_{CO_2,weighted} = \left(\sum_{j=1}^k UF_j \right)_{ave} \times M_{CO_2,CD,declared} + \left(1 - \left(\sum_{j=1}^k UF_j \right)_{ave} \right) \times M_{CO_2,CS,declared}$$

where:

- $M_{CO_2,weighted}$ is the utility-factor weighted charge-depleting CO₂ mass emission, g/km.
- $M_{CO_2,CD,declared}$ is the declared charge-depleting CO₂ mass emission according to Table A8/8, step no. 14, g/km.
- $M_{CO_2,CS,declared}$ is the declared charge-sustaining CO₂ mass emission according to Table A8/5, step no. 7, g/km.
- $\left(\sum_{j=1}^k UF_j \right)_{ave}$ is the average of the sum of utility factors of each charge-depleting test.
- j is the index number of the considered phase;

k is the number of phases driven until the end of the transition cycle according to paragraph 3.2.4.4. of this annex.

In the case that the interpolation method is applied for CO₂, k shall be the number of phases driven up to the end of the transition cycle of vehicle L, $n_{veh,L}$, for the application of both equations of this paragraph.

If the transition cycle number driven by vehicle H, $n_{veh,H}$, and, if applicable, by an individual vehicle within the vehicle interpolation family $n_{veh,ind}$ is lower than the transition cycle number driven by vehicle L, $n_{veh,L}$, the confirmation cycle of vehicle H and, if applicable, an individual vehicle shall be included in the calculation. The CO₂ mass emission of each phase of the confirmation cycle shall then be corrected to an electric energy consumption of zero ($EC_{DC,CD,j} = 0$) by using the CO₂ correction coefficient according to Appendix 2 to this annex.

4.1.3.2. The utility factor-weighted particle number emission shall be calculated using the following equation:

$$PN_{weighted} = \sum_{j=1}^k (UF_j \times PN_{CD,j}) + (1 - \sum_{j=1}^k UF_j) \times PN_{CS}$$

where:

$PN_{weighted}$ is the utility factor-weighted particle number emission, particles per kilometre;

UF_j is the utility factor of phase j according to Appendix 5 to this annex;

$PN_{CD,j}$ is the particle number emission during phase j determined according to paragraph 4. of Annex B7 for the charge-depleting Type 1 test, particles per kilometre;

PN_{CS} is the particle number emission determined according to paragraph 4.1.1. of this annex for the charge-sustaining Type 1 test, particles per kilometre;

j is the index number of the considered phase;

k is the number of phases driven until the end of transition cycle n according to paragraph 3.2.4.4. of this annex.

4.1.3.3. The utility factor-weighted particulate matter emission shall be calculated using the following equation:

$$PM_{weighted} = \sum_{c=1}^{n_c} (UF_c \times PM_{CD,c}) + (1 - \sum_{c=1}^{n_c} UF_c) \times PM_{CS}$$

where:

$PM_{weighted}$ is the utility factor-weighted particulate matter emission, mg/km;

UF_c is the utility factor of cycle c according to Appendix 5 to this annex;

$PM_{CD,c}$ is the charge-depleting particulate matter emission during cycle c determined according to paragraph 3.3. of Annex B7 for the charge-depleting Type 1 test, mg/km;

PM_{CS} is the particulate matter emission of the charge-sustaining Type 1 test according to paragraph 4.1.1. of this annex, mg/km;

c is the index number of the cycle considered;

n_c is the number of applicable WLTP test cycles driven until the end of the transition cycle n according to paragraph 3.2.4.4. of this annex.

4.2. Calculation of fuel consumption and fuel efficiency

4.2.1. Charge-sustaining fuel consumption and fuel efficiency for OVC-HEVs, NOVC-HEVs and NOVC-FCHVs

4.2.1.1. The charge-sustaining fuel consumption and fuel efficiency for OVC-HEVs and NOVC-HEVs shall be calculated stepwise according to Table A8/6.

Table A8/6

Calculation of final charge-sustaining fuel consumption and fuel efficiency for OVC-HEVs, NOVC-HEVs (FE applicable for results after 3 phases only)

Step No.	Source	Input	Process	Output
1	Output step 6, Table A8/5 Output step 7, Table A8/5	$M_{i,CS,c,6}$, g/km; $M_{CO_2,CS,c,6}$, g/km; $FE_{CS,declared}$, km/l; $M_{CO_2,CS,c,7}$, g/km; $M_{CO_2,CS,p,7}$, g/km.	Calculation of fuel consumption $FC_{CS,c}$ according to paragraph 6. of Annex B7 based on $M_{CO_2,CS,c,7}$ and conversion to fuel efficiency $FE_{CS,c}$ for phase value $FE_{CS,c} = FE_{CS,declared}$, The calculation of fuel consumption shall be performed separately for the applicable cycle and its phases. For that purpose: (a) the applicable phase or cycle CO_2 values shall be used; (b) the criteria emission over the complete cycle shall be used.	$FC_{CS,c,1}$, l/100 km; $FE_{CS,c,1}$, km/l; $FC_{CS,p,1}$, l/100 km. $FE_{CS,p,1}$ km/l
2	Output step 1 Interpolation family result. If the interpolation method is not applied, step No. 3 is not required and the output of this step is the final result.	$FC_{CS,c,1}$, l/100 km; $FC_{CS,p,1}$, l/100 km; $FE_{CS,c,1}$, km/l. $FE_{CS,p,1}$, km/l	For FC and FE, the values derived in step No. 1 of this table shall be used. In the case that the interpolation method is applied, intermediate rounding shall be applied according to paragraph 6.1.8. of this Regulation. FC and FE values shall be rounded to three places of decimal. Output is available for vehicles H and vehicle L and, if applicable, for vehicle M. In the case that the interpolation method is not applied, final rounding shall be applied according to paragraph 6.1.8. of this Regulation. FC and FE values shall be rounded to first place of decimal.	$FC_{CS,c}$, l/100 km; $FC_{CS,p}$, l/100 km; $FE_{CS,c}$, km/l. $FE_{CS,p}$, km/l.
3	Output step 2	$FC_{CS,c}$, l/100 km; $FC_{CS,p}$, l/100 km;	Fuel consumption calculation according to paragraph 4.5.5.1.1. of this annex for individual	$FC_{CS,c,ind}$, l/100 km; $FC_{CS,p,ind}$, l/100 km;

<i>Step No.</i>	<i>Source</i>	<i>Input</i>	<i>Process</i>	<i>Output</i>
Result of an individual vehicle. Final FC and FE result.		FE _{CS,c} , km/l. FE _{CS,p} , km/l.	vehicles in an interpolation family. Fuel efficiency calculation according to paragraph 4.5.5.1.2. of this annex for individual vehicles in an interpolation family. Final rounding of individual vehicle values shall be performed according to paragraph 6.1.8. of this Regulation. FC and FE values shall be rounded to the first place of decimal. Output is available for each individual vehicle.	FE _{CS,c,ind} , km/l. FE _{CS,p,ind} , km/l.

4.2.1.2. Charge-sustaining fuel consumption and fuel efficiency for NOVC-FCHVs

4.2.1.2.1. Stepwise procedure for calculating the final test fuel consumption and fuel efficiency results of the charge-sustaining Type 1 test for NOVC-FCHVs

The results shall be calculated in the order described in Table A8/7. All applicable results in the column "Output" shall be recorded. The column "Process" describes the paragraphs to be used for calculation or contains additional calculations.

For the purpose of this table, the following nomenclature within the equations and results is used:

- c complete applicable test cycle;
- p every applicable cycle phase; [for the purpose of EAER_{city} calculation (as applicable), p shall represent the city driving cycle;]
- CS charge-sustaining

Table A8/7

Calculation of final charge-sustaining fuel consumption for NOVC-FCHVs (FE applicable for results after 3 phases only)

For results after 4-phases all the calculations in this table shall be for the complete cycle

For the 3-phase WLTP all the calculations in this table shall be for the 3-phase cycle and also for individual phases;

<i>Step No.</i>	<i>Source</i>	<i>Input</i>	<i>Process</i>	<i>Output</i>
1	Appendix 7 to this annex.	Non-balanced charge-sustaining fuel consumption FC _{CS,nb} , kg/100km	Charge-sustaining fuel consumption FC _{CS,c,1} according to paragraph 2.2.6. of Appendix 7 to this annex. The calculation of fuel consumption shall be performed separately for the applicable cycle and its phases.	FC _{CS,p,1} , kg/100 km; FC _{CS,c,1} , kg/100 km.

			For that purpose, the applicable phase or cycle FC values shall be used; Phase-specific values according to paragraph 2.2.7. of Appendix 7 to this annex).	
2	Output step 1	$FC_{CS,p,1}$, kg/100 km; $FC_{CS,c,1}$, kg/100 km.	REESS electric energy change correction. Paragraphs 4.2.1.2.2. to 4.2.1.2.5. (where applicable) inclusive of this annex.	$FC_{CS,c,2}$, kg/100 km; For results after 3 phases $FC_{CS,p,2}$, kg/100 km;
3 Result of a single test.	Output step 2	$FC_{CS,p,2}$, kg/100 km; $FC_{CS,c,2}$, kg/100 km.	$FC_{CS,p,3} = FC_{CS,p,2}$ $FC_{CS,c,3} = FC_{CS,c,2}$ For results after 3 phases Conversion of fuel consumption FC into fuel efficiency FE	$FC_{CS,p,3}$, kg/100 km; $FC_{CS,c,3}$, kg/100 km. $FE_{CS,p,3}$, km/kg. $FE_{CS,c,3}$, km/kg.
4	Output step 3	For every test: $FC_{CS,p,3}$, kg/100 km; $FC_{CS,c,3}$, kg/100 km. $FE_{CS,p,3}$, km/kg. $FE_{CS,c,3}$, km/kg.	Averaging of tests and declared value according to paragraphs 1.2. to 1.2.3. inclusive of Annex B6.	$FC_{CS,p,4}$, kg/100 km; $FC_{CS,c,4}$, kg/100 km. $FE_{CS,p,4}$, km/kg. $FE_{CS,c,4}$, km/kg.
5 Interpolation family result. If the interpolation method is not applied, step No. 6 is not required and the output of this step is the final result. FC_{CS} results of a Type 1 test for a test vehicle.	Output step 4	$FC_{CS,p,4}$, kg/100 km; $FC_{CS,c,4}$, kg/100 km; $FC_{CS,c,declared}$, kg/100 km. $FE_{CS,p,4}$, km/kg. $FE_{CS,c,4}$, km/kg; $FE_{CS,c,declared}$, km/kg.	Alignment of phase values. Paragraph 1.2.4. of Annex B6, and: $FC_{CS,c,5} = FC_{CS,c,declared}$ $FE_{CS,c,5} = FE_{CS,c,declared}$ FC and FE values shall be rounded according to paragraph 6.1.8. of this Regulation to the second place of decimal. In the case that the interpolation method is not applied, final rounding shall be applied according to paragraph 6.1.8. of this Regulation to the first place of decimal.	$FC_{CS,p,5}$, kg/100 km; $FC_{CS,c,5}$, kg/100 km $FE_{CS,p,5}$, km/kg. $FE_{CS,c,5}$, km/kg.
6 Result of an individual vehicle. Final FC result.	Output step 5	$FC_{CS,c,5}$, kg/100 km;	Fuel consumption calculation according to paragraph 4.5.5.1.3. of this annex for individual vehicles in an interpolation family. Final rounding of individual vehicle values shall be performed according to paragraph 6.1.8. of this Regulation.	$FC_{CS,c,ind}$, kg/100 km;

			FC values shall be rounded to the first place of decimal. Output is available for each individual vehicle.	
--	--	--	---	--

- 4.2.1.2.2. In the case that the correction according to paragraph 1.1.4. of Appendix 2 to this annex was not applied, the following charge-sustaining fuel consumption shall be used:

$$FC_{CS} = FC_{CS,nb}$$

where:

FC_{CS} is the charge-sustaining fuel consumption of the charge-sustaining Type 1 test according to Table A8/7, step No. 2, kg/100 km;

$FC_{CS,nb}$ is the non-balanced charge-sustaining fuel consumption of the charge-sustaining Type 1 test, not corrected for the energy balance, according to Table A8/7, step No. 1, kg/100 km.

- 4.2.1.2.3. If the correction of the fuel consumption is required according to paragraph 1.1.3. of Appendix 2 to this annex or in the case that the correction according to paragraph 1.1.4. of Appendix 2 to this annex was applied, the fuel consumption correction coefficient shall be determined according to paragraph 2. of Appendix 2 to this annex. The corrected charge-sustaining fuel consumption shall be determined using the following equation:

$$FC_{CS} = FC_{CS,nb} - K_{fuel,FCHV} \times EC_{DC,CS}$$

where:

FC_{CS} is the charge-sustaining fuel consumption of the charge-sustaining Type 1 test according to Table A8/7, step No. 2, kg/100 km;

$FC_{CS,nb}$ is the non-balanced fuel consumption of the charge-sustaining Type 1 test, not corrected for the energy balance, according to Table A8/7, step No. 1, kg/100 km;

$EC_{DC,CS}$ is the electric energy consumption of the charge-sustaining Type 1 test according to paragraph 4.3. of this annex, Wh/km;

$K_{fuel,FCHV}$ is the fuel consumption correction coefficient according to paragraph 2.3.1. of Appendix 2 to this annex, (kg/100 km)/(Wh/km).

- 4.2.1.2.4. In the case that phase-specific fuel consumption correction coefficients have not been determined, the phase-specific fuel consumption shall be calculated using the following equation:

$$FC_{CS,p} = FC_{CS,nb,p} - K_{fuel,FCHV} \times EC_{DC,CS,p}$$

where:

$FC_{CS,p}$ is the charge-sustaining fuel consumption of phase p of the charge-sustaining Type 1 test according to Table A8/7, step No. 2, kg/100 km;

$FC_{CS,nb,p}$ is the non-balanced fuel consumption of phase p of the charge-sustaining Type 1 test, not corrected for the energy balance, according to Table A8/7, step No. 1, kg/100 km;

- $EC_{DC,CS,p}$ is the electric energy consumption of phase p of the charge-sustaining Type 1 test, determined according to paragraph 4.3. of this annex, Wh/km;
- $K_{fuel,FCHV}$ is the fuel consumption correction coefficient according to paragraph 2.3.1. of Appendix 2 to this annex, (kg/100 km)/(Wh/km);
- p is the index of the individual phase within the applicable WLTP test cycle.

4.2.1.2.5.

In the case that phase-specific fuel consumption correction coefficients have been determined, the phase-specific fuel consumption shall be calculated using the following equation:

$$FC_{CS,p} = FC_{CS,nb,p} - K_{fuel,FCHV,p} \times EC_{DC,CS,p}$$

where:

- $FC_{CS,p}$ is the charge-sustaining fuel consumption of phase p of the charge-sustaining Type 1 test according to Table A8/7, step No. 2, kg/100 km;
- $FC_{CS,nb,p}$ is the non-balanced fuel consumption of phase p of the charge-sustaining Type 1 test, not corrected for the energy balance, according to Table A8/7, step No. 1, kg/100 km;
- $EC_{DC,CS,p}$ is the electric energy consumption of phase p of the charge-sustaining Type 1 test, determined according to paragraph 4.3. of this annex, Wh/km;
- $K_{fuel,FCHV,p}$ is the fuel consumption correction coefficient for the correction of the phase p according to paragraph 2.3.1.2. of Appendix 2 to this annex, (kg/100 km)/(Wh/km);
- p is the index of the individual phase within the applicable WLTP test cycle.

4.2.2.

The charge-depleting fuel consumption for OVC-HEVs

For 4-phase WLTP test:

The utility factor-weighted charge-depleting fuel consumption FC_{CD} shall be calculated using the following equation:

$$FC_{CD} = \frac{\sum_{j=1}^k (UF_j \times FC_{CD,j})}{\sum_{j=1}^k UF_j}$$

where:

- FC_{CD} is the utility factor weighted charge-depleting fuel consumption, l/100 km;
- $FC_{CD,j}$ is the fuel consumption for phase j of the charge-depleting Type 1 test, determined according to paragraph 6. of Annex B7, l/100 km;
- UF_j is the utility factor of phase j according to Appendix 5 to this annex;
- j is the index number for the considered phase;
- k is the number of phases driven up to the end of the transition cycle according to paragraph 3.2.4.4. of this annex.

In the case that the interpolation method is applied, k shall be the number of phases driven up to the end of the transition cycle of vehicle L n_{veh_L} .

If the transition cycle number driven by vehicle H, n_{veh_H} , and, if applicable, by an individual vehicle within the vehicle interpolation family, n_{veh_ind} , is lower than the transition cycle number driven by vehicle L n_{veh_L} the confirmation cycle of vehicle H and, if applicable, an individual vehicle shall be included in the calculation. The fuel consumption of each phase of the confirmation cycle shall be calculated according to paragraph 6. of Annex B7 with the criteria emission over the complete confirmation cycle and the applicable CO₂ phase value which shall be corrected to an electric energy consumption of zero, $EC_{DC,CD,j} = 0$, by using the CO₂ mass correction coefficient (K_{CO_2}) according to Appendix 2 to this annex.

For 3-phase WLTP test

The charge-depleting fuel efficiency FE_{CD} shall be calculated using the following equation:

$$FE_{CD} = \frac{R_{CDA}}{\sum_{c=1}^{n-1} d_c \times \frac{1}{FE_{CD,c}} + d_n \times \frac{k_{CD}}{FE_{CD,n}}}$$

where:

FE_{CD} is the charge-depleting fuel efficiency, km/l;

R_{CDA} actual charge-depleting range defined in paragraph 4.4.5. of this Annex, km;

$FE_{CD,c}$ is the fuel efficiency for cycle c of the charge-depleting Type 1 test, determined according to paragraph 6. of Annex B7, km/l;

c is the index number for the considered cycle;

n is the number of applicable WLTP test cycles driven up to the end of the transition cycle according to paragraph 3.2.4.4. of this annex

d_c is the distance driven in the applicable WLTP test cycle c of the charge-depleting Type 1 test, km;

d_n is the distance driven in the applicable WLTP test cycle n of the charge-depleting Type 1 test, km;

$$k_{CD} = \frac{M_{CO_2,CS} - M_{CO_2,CD,n}}{M_{CO_2,CS} - M_{CO_2,CD,ave,n-1}}$$

4.2.3. This paragraph is applicable only for 4-phase WLTP test

Utility factor-weighted fuel consumption for OVC-HEVs

The utility factor-weighted fuel consumption for OVC-HEVs from the charge-depleting and charge-sustaining Type 1 test shall be calculated using the following equation:

$$FC_{weighted} = \sum_{j=1}^k (UF_j \times FC_{CD,j}) \times \frac{M_{CO_2,CD,declared}}{M_{CO_2,CD,ave}} + (1 - \sum_{j=1}^k UF_j) \times FC_{CS}$$

where:

$FC_{weighted}$ is the utility factor-weighted fuel consumption, l/100 km;

- UF_j is the utility factor of phase j according to Appendix 5 to this annex;
- $FC_{CD,j}$ is the fuel consumption of phase j of the charge-depleting Type 1 test, determined according to paragraph 6. of Annex B7, l/100 km;
- $M_{CO_2,CD,declared}$ is the declared charge-depleting CO_2 mass emission according to Table A8/8, step no. 14, g/km;
- $M_{CO_2,CD,ave}$ is the average charge-depleting CO_2 mass emission according to Table A8/8, step no. 13, g/km;
- FC_{CS} is the fuel consumption determined according to Table A8/6, step No. 1, l/100 km;
- j is the index number for the considered phase;
- k is the number of phases driven up to the end of the transition cycle according to paragraph 3.2.4.4. of this annex.

In the case that the interpolation method is applied, k shall be the number of phases driven up to the end of the transition cycle of vehicle L $n_{veh,L}$.

If the transition cycle number driven by vehicle H, $n_{veh,H}$, and, if applicable, by an individual vehicle within the vehicle interpolation family $n_{veh,ind}$ is lower than the transition cycle number driven by vehicle L, $n_{veh,L}$, the confirmation cycle of vehicle H and, if applicable, an individual vehicle shall be included in the calculation.

The fuel consumption of each phase of the confirmation cycle shall be calculated according to paragraph 6. of Annex B7 with the criteria emission over the complete confirmation cycle and the applicable CO_2 phase value which shall be corrected to an electric energy consumption of zero $EC_{DC,CD,j} = 0$ by using the CO_2 mass correction coefficient (K_{CO_2}) according to Appendix 2 to this annex.

4.3. Calculation of electric energy consumption

For the determination of the electric energy consumption based on the current and voltage determined according to Appendix 3 to this annex, the following equations shall be used:

$$EC_{DC,j} = \frac{\Delta E_{REESS,j}}{d_j}$$

where:

$EC_{DC,j}$ is the electric energy consumption over the considered period j based on the REESS depletion, Wh/km;

$\Delta E_{REESS,j}$ is the electric energy change of all REESSs during the considered period j , Wh;

d_j is the distance driven in the considered period j , km;

and

$$\Delta E_{REESS,j} = \sum_{i=1}^n \Delta E_{REESS,j,i}$$

where:

$\Delta E_{REESS,j,i}$ is the electric energy change of REESS i during the considered period j , Wh;

and

$$\Delta E_{\text{REESS},j,i} = \frac{1}{3600} \times \int_{t_0}^{t_{\text{end}}} U(t)_{\text{REESS},j,i} \times I(t)_{j,i} dt$$

where:

$U(t)_{\text{REESS},j,i}$ is the voltage of REESS i during the considered period j determined according to Appendix 3 to this annex, V;

t_0 is the time at the beginning of the considered period j , s;

t_{end} is the time at the end of the considered period j , s;

$I(t)_{j,i}$ is the electric current of REESS i during the considered period j determined according to Appendix 3 to this annex, A;

i is the index number of the considered REESS;

n is the total number of REESS;

j is the index for the considered period, where a period can be any combination of phases or cycles;

$\frac{1}{3600}$ is the conversion factor from Ws to Wh.

4.3.1. This paragraph is applicable only for 4-phase WLTP test

Utility factor-weighted charge-depleting electric energy consumption based on the recharged electric energy from the mains for OVC-HEVs

The utility factor-weighted charge-depleting electric energy consumption based on the recharged electric energy from the mains shall be calculated using the following equation:

$$EC_{\text{AC,CD}} = \frac{\sum_{j=1}^k (UF_j \times EC_{\text{AC,CD},j})}{\sum_{j=1}^k UF_j}$$

where:

$EC_{\text{AC,CD}}$ is the utility factor-weighted charge-depleting electric energy consumption based on the recharged electric energy from the mains, Wh/km;

UF_j is the utility factor of phase j according to Appendix 5 to this annex;

$EC_{\text{AC,CD},j}$ is the electric energy consumption based on the recharged electric energy from the mains of phase j , Wh/km;

and

$$EC_{\text{AC,CD},j} = EC_{\text{DC,CD},j} \times \frac{E_{\text{AC}}}{\sum_{j=1}^k \Delta E_{\text{REESS},j}}$$

where:

$EC_{\text{DC,CD},j}$ is the electric energy consumption based on the REESS depletion of phase j of the charge-depleting Type 1 test according to paragraph 4.3. of this annex, Wh/km;

E_{AC} is the recharged electric energy from the mains determined according to paragraph 3.2.4.6. of this annex, Wh;

$\Delta E_{\text{REESS},j}$ is the electric energy change of all REESSs of phase j according to paragraph 4.3. of this annex, Wh;

j is the index number for the considered phase;

k is the number of phases driven up to the end of the transition cycle according to paragraph 3.2.4.4. of this annex.

In the case that the interpolation method is applied, k is the number of phases driven up to the end of the transition cycle of L, n_{veh_L} .

4.3.2. This paragraph is applicable for 4-phase WLTP test only:

Utility factor-weighted electric energy consumption based on the recharged electric energy from the mains for OVC-HEVs

The utility factor-weighted electric energy consumption based on the recharged electric energy from the mains shall be calculated using the following equation:

$$EC_{AC,weighted} = (\sum_{j=1}^k UF_j) \times EC_{AC,CD,declared}$$

where:

$EC_{AC,weighted}$ is the utility factor-weighted electric energy consumption based on the recharged electric energy from the mains, Wh/km;

UF_j is the utility factor of phase j according to Appendix 5 to this annex;

$EC_{AC,CD,declared}$ is the declared charge-depleting electric energy consumption based on the recharged electric energy from the mains for OVC-HEVs according to Table A8/8, step 14, Wh/km;

j is the index number for the considered phase;

k is the number of phases driven up to the end of the transition cycle according to paragraph 3.2.4.4. of this annex.

In the case that the interpolation method is applied, k is the number of phases driven up to the end of the transition cycle of vehicle L, n_{veh_L} .

4.3.3. Electric energy consumption for OVC-HEVs

4.3.3.1. Determination of cycle-specific electric energy consumption

The electric energy consumption based on the recharged electric energy from the mains and the equivalent all-electric range shall be calculated using the following equation:

$$EC = \frac{E_{AC}}{EAER}$$

where:

EC is the electric energy consumption of the applicable WLTP test cycle based on the recharged electric energy from the mains and the equivalent all-electric range, Wh/km;

E_{AC} is the recharged electric energy from the mains according to paragraph 3.2.4.6. of this annex, Wh;

$EAER$ is the equivalent all-electric range for OVC-HEVs according to paragraph 4.4.4.1. of this annex, km.

4.3.3.2. Determination of phase-specific electric energy consumption

The phase-specific electric energy consumption based on the recharged electric energy from the mains and the phase-specific equivalent all-electric range shall be calculated using the following equation:

$$EC_p = \frac{E_{AC}}{EAER_p}$$

where:

EC_p is the phase-specific electric energy consumption based on the recharged electric energy from the mains and the equivalent all-electric range, Wh/km;

E_{AC} is the recharged electric energy from the mains according to paragraph 3.2.4.6. of this annex, Wh;

$EAER_p$ is the phase-specific equivalent all-electric range according to paragraph 4.4.4.2. of this annex, km.

4.3.4. Electric energy consumption of PEVs

4.3.4.1. The electric energy consumption determined in this paragraph shall be calculated only if the vehicle was able to follow the applicable test cycle within the speed trace tolerances according to paragraph 2.6.8.3.1.2. of Annex B6 during the entire considered period.

4.3.4.2. Electric energy consumption determination of the applicable WLTP test cycle

The electric energy consumption of the applicable WLTP test cycle based on the recharged electric energy from the mains and the pure electric range shall be calculated using the following equation:

$$EC_{WLTC} = \frac{E_{AC}}{PER_{WLTC}}$$

where:

EC_{WLTC} is the electric energy consumption of the applicable WLTP test cycle based on the recharged electric energy from the mains and the pure electric range for the applicable WLTP test cycle, Wh/km;

E_{AC} is the recharged electric energy from the mains according to paragraph 3.4.4.3. of this annex, Wh;

PER_{WLTC} is the pure electric range for the applicable WLTP test cycle as calculated according to paragraph 4.4.2.1.1. or paragraph 4.4.2.2.1. of this annex, depending on the PEV test procedure used, km.

4.3.4.3. Electric energy consumption determination of the applicable WLTP city test cycle (if applicable)

The electric energy consumption of the applicable WLTP city test cycle based on the recharged electric energy from the mains and the pure electric range for the applicable WLTP city test cycle shall be calculated using the following equation:

$$EC_{city} = \frac{E_{AC}}{PER_{city}}$$

where:

EC_{city} is the electric energy consumption of the applicable WLTP city test cycle based on the recharged electric energy from the mains and the pure electric range for the applicable WLTP city test cycle, Wh/km;

E_{AC} is the recharged electric energy from the mains according to paragraph 3.4.4.3. of this annex, Wh;

PER_{city} is the pure electric range for the applicable WLTP city test cycle as calculated according to paragraph 4.4.2.1.2. or paragraph 4.4.2.2.2. of this annex, depending on the PEV test procedure used, km.

4.3.4.4. Electric energy consumption determination of the phase-specific values

The electric energy consumption of each individual phase based on the recharged electric energy from the mains and the phase-specific pure electric range shall be calculated using the following equation:

$$EC_p = \frac{E_{AC}}{PER_p}$$

where:

EC_p is the electric energy consumption of each individual phase p based on the recharged electric energy from the mains and the phase-specific pure electric range, Wh/km

E_{AC} is the recharged electric energy from the mains according to paragraph 3.4.4.3. of this annex, Wh;

PER_p is the phase-specific pure electric range as calculated according to paragraph 4.4.2.1.3. or paragraph 4.4.2.2.3. of this annex, depending on the PEV test procedure used, km.

4.4. Calculation of electric ranges

4.4.1. All-electric ranges AER and AER_{city} for OVC-HEVs

4.4.1.1. All-electric range AER

The all-electric range AER for OVC-HEVs shall be determined from the charge-depleting Type 1 test described in paragraph 3.2.4.3. of this annex as part of the Option 1 test sequence and is referenced in paragraph 3.2.6.1. of this annex as part of the Option 3 test sequence by driving the applicable WLTP test cycle according to paragraph 1.4.2.1. of this annex. The AER is defined as the distance driven from the beginning of the charge-depleting Type 1 test to the point in time where the combustion engine starts consuming fuel.

4.4.1.2. All-electric range city AER_{city} (if applicable)

4.4.1.2.1. The all-electric range city AER_{city} for OVC-HEVs shall be determined from the charge-depleting Type 1 test described in paragraph 3.2.4.1., 3.2.4.2. and 3.2.4.3. of this annex as part of the Option 1 test sequence by driving the applicable WLTP city test cycle according to paragraph 1.4.2.2. of this annex. The AER_{city} is defined as the distance driven from the beginning of the charge-depleting Type 1 test to the point in time where the combustion engine starts consuming fuel.

The point in time where the combustion engine starts consuming fuel shall be considered as the break-off criterion and shall replace the break-off criterion described in paragraph 3.2.4.4.

4.4.1.2.2. As an alternative to paragraph 4.4.1.2.1. of this annex, the all-electric range city AER_{city} may be determined from the charge-depleting Type 1 test described in paragraph 3.2.4.3. of this annex by driving the applicable WLTP test cycles according to paragraph 1.4.2.1. of this annex. In that case, the charge-depleting Type 1 test by driving the applicable WLTP city test cycle shall be omitted and the all-electric range city AER_{city} shall be calculated using the following equation:

$$AER_{city} = \frac{UBE_{city}}{EC_{DC,city}}$$

where:

- AER_{city} is the all-electric range city, km;
- UBE_{city} is the usable REESS energy determined from the beginning of the charge-depleting Type 1 test described in paragraph 3.2.4.3. of this annex by driving applicable WLTP test cycles until the point in time when the combustion engine starts consuming fuel, Wh;
- $EC_{DC,city}$ is the weighted electric energy consumption of the pure electrically driven applicable WLTP city test cycles of the charge-depleting Type 1 test described in paragraph 3.2.4.3. of this annex by driving applicable WLTP test cycle(s), Wh/km;

and

$$UBE_{city} = \sum_{j=1}^{k+1} \Delta E_{REESS,j}$$

where:

- $\Delta E_{REESS,j}$ is the electric energy change of all REESSs during phase j, Wh;
- j is the index number of the considered phase;
- k+1 is the number of the phases driven from the beginning of the test until the point in time when the combustion engine starts consuming fuel;

and

$$EC_{DC,city} = \sum_{j=1}^{n_{city,pe}} EC_{DC,city,j} \times K_{city,j}$$

where:

- $EC_{DC,city,j}$ is the electric energy consumption for the jth pure electrically driven WLTP city test cycle of the charge-depleting Type 1 test according to paragraph 3.2.4.3. of this annex by driving applicable WLTP test cycles, Wh/km;
- $K_{city,j}$ is the weighting factor for the jth pure electrically driven applicable WLTP city test cycle of the charge-depleting Type 1 test according to paragraph 3.2.4.3. of this annex by driving applicable WLTP test cycles;
- j is the index number of the pure electrically driven applicable WLTP city test cycle considered;
- $n_{city,pe}$ is the number of pure electrically driven applicable WLTP city test cycles;

and

$$K_{city,1} = \frac{\Delta E_{REESS,city,1}}{UBE_{city}}$$

where:

- $\Delta E_{REESS,city,1}$ is the electric energy change of all REESSs during the first applicable WLTP city test cycle of the charge-depleting Type 1 test, Wh;

and

$$K_{city,j} = \frac{1-K_{city,1}}{n_{city,pe}-1} \text{ for } j = 2 \text{ to } n_{city,pe}.$$

4.4.2. Pure electric range for PEVs

The ranges determined in this paragraph shall only be calculated if the vehicle was able to follow the applicable WLTP test cycle within the speed trace tolerances according to paragraph 2.6.8.3.1.2. of Annex B6 during the entire considered period.

4.4.2.1. Determination of the pure electric ranges when the shortened Type 1 test procedure is applied

4.4.2.1.1. The pure electric range for the applicable WLTP test cycle PER_{WLTC} for PEVs shall be calculated from the shortened Type 1 test as described in paragraph 3.4.4.2. of this annex using the following equations:

$$PER_{WLTC} = \frac{UBE_{STP}}{EC_{DC,WLTC}}$$

where:

PER_{WLTC} is the pure electric range for the applicable WLTC test cycle for PEVs, km;

UBE_{STP} is the usable REESS energy determined from the beginning of the shortened Type 1 test procedure until the break-off criterion as defined in paragraph 3.4.4.2.3. of this annex is reached, Wh;

$EC_{DC,WLTC}$ is the weighted electric energy consumption for the applicable WLTP test cycle of the shortened Type 1 test procedure Type 1 test, Wh/km;

and

$$UBE_{STP} = \Delta E_{REESS,DS_1} + \Delta E_{REESS,DS_2} + \Delta E_{REESS,CSS_M} + \Delta E_{REESS,CSS_E}$$

where:

$\Delta E_{REESS,DS_1}$ is the electric energy change of all REESSs during DS_1 of the shortened Type 1 test procedure, Wh;

$\Delta E_{REESS,DS_2}$ is the electric energy change of all REESSs during DS_2 of the shortened Type 1 test procedure, Wh;

$\Delta E_{REESS,CSS_M}$ is the electric energy change of all REESSs during CSS_M of the shortened Type 1 test procedure, Wh;

$\Delta E_{REESS,CSS_E}$ is the electric energy change of all REESSs during CSS_E of the shortened Type 1 test procedure, Wh;

and

$$EC_{DC,WLTC} = \sum_{j=1}^2 EC_{DC,WLTC,j} \times K_{WLTC,j}$$

where:

$EC_{DC,WLTC,j}$ is the electric energy consumption for the applicable WLTP test cycle of DS_j of the shortened Type 1 test procedure according to paragraph 4.3. of this annex, Wh/km;

$K_{WLTC,j}$ is the weighting factor for the applicable WLTP test cycle of DS_j of the shortened Type 1 test procedure;

and:

$$K_{WLTC,1} = \frac{\Delta E_{REESS,WLTC,1}}{UBE_{STP}} \text{ and } K_{WLTC,2} = 1 - K_{WLTC,1}$$

where:

- $K_{WLTC,j}$ is the weighting factor for the applicable WLTP test cycle of DS_j of the shortened Type 1 test procedure;
- $\Delta E_{REESS,WLTC,1}$ is the electric energy change of all REESSs during the applicable WLTP test cycle from DS_1 of the shortened Type 1 test procedure, Wh.

4.4.2.1.2. Pure Electric Range city (PER_{city}) (if applicable)

The pure electric range for the applicable WLTP city test cycle PER_{city} for PEVs shall be calculated from the shortened Type 1 test procedure as described in paragraph 3.4.4.2. of this annex using the following equations:

$$PER_{city} = \frac{UBE_{STP}}{EC_{DC,city}}$$

where:

- PER_{city} is the pure electric range for the applicable WLTP city test cycle for PEVs, km;
- UBE_{STP} is the usable REESS energy according to paragraph 4.4.2.1.1. of this annex, Wh;
- $EC_{DC,city}$ is the weighted electric energy consumption for the applicable WLTP city test cycle of DS_1 and DS_2 of the shortened Type 1 test procedure, Wh/km;

and

$$EC_{DC,city} = \sum_{j=1}^4 EC_{DC,city,j} \times K_{city,j}$$

where:

- $EC_{DC,city,j}$ is the electric energy consumption for the applicable WLTP city test cycle where the first applicable WLTP city test cycle of DS_1 is indicated as $j = 1$, the second applicable WLTP city test cycle of DS_1 is indicated as $j = 2$, the first applicable WLTP city test cycle of DS_2 is indicated as $j = 3$ and the second applicable WLTP city test cycle of DS_2 is indicated as $j = 4$ of the shortened Type 1 test procedure according to paragraph 4.3. of this annex, Wh/km;
- $K_{city,j}$ is the weighting factor for the applicable WLTP city test cycle where the first applicable WLTP city test cycle of DS_1 is indicated as $j = 1$, the second applicable WLTP city test cycle of DS_1 is indicated as $j = 2$, the first applicable WLTP city test cycle of DS_2 is indicated as $j = 3$ and the second applicable WLTP city test cycle of DS_2 is indicated as $j = 4$,

and

$$K_{city,1} = \frac{\Delta E_{REESS,city,1}}{UBE_{STP}} \text{ and } K_{city,j} = \frac{1 - K_{city,1}}{3} \text{ for } j = 2 \dots 4$$

where:

- $\Delta E_{REESS,city,1}$ is the energy change of all REESSs during the first applicable WLTP city test cycle of DS_1 of the shortened Type 1 test procedure, Wh.

4.4.2.1.3. The phase-specific pure electric range PER_p for PEVs shall be calculated from the Type 1 test as described in paragraph 3.4.4.2. of this annex by using the following equations:

$$PER_p = \frac{UBE_{STP}}{EC_{DC,p}}$$

where:

- PER_p is the phase-specific pure electric range for PEVs, km;
 UBE_{STP} is the usable REESS energy according to paragraph 4.4.2.1.1. of this annex, Wh;
 EC_{DC,p} is the weighted electric energy consumption for each individual phase of DS₁ and DS₂ of the shortened Type 1 test procedure, Wh/km;

In the case that phase p = low and phase p = medium, the following equations shall be used:

$$EC_{DC,p} = \sum_{j=1}^4 EC_{DC,p,j} \times K_{p,j}$$

where:

EC_{DC,p,j} is the electric energy consumption for phase p where the first phase p of DS₁ is indicated as j = 1, the second phase p of DS₁ is indicated as j = 2, the first phase p of DS₂ is indicated as j = 3 and the second phase p of DS₂ is indicated as j = 4 of the shortened Type 1 test procedure according to paragraph 4.3. of this annex, Wh/km;

K_{p,j} is the weighting factor for phase p where the first phase p of DS₁ is indicated as j = 1, the second phase p of DS₁ is indicated as j = 2, the first phase p of DS₂ is indicated as j = 3, and the second phase p of DS₂ is indicated as j = 4 of the shortened Type 1 test procedure;

and

$$K_{p,1} = \frac{\Delta E_{REESS,p,1}}{UBE_{STP}} \text{ and } K_{p,j} = \frac{1 - K_{p,1}}{3} \text{ for } j = 2 \dots 4$$

where:

ΔE_{REESS,p,1} is the energy change of all REESSs during the first phase p of DS₁ of the shortened Type 1 test procedure, Wh.

In the case that phase p = high and phase p = extra high, the following equations shall be used:

$$EC_{DC,p} = \sum_{j=1}^2 EC_{DC,p,j} \times K_{p,j}$$

where:

EC_{DC,p,j} is the electric energy consumption for phase p of DS_j of the shortened Type 1 test procedure according to paragraph 4.3. of this annex, Wh/km;

K_{p,j} is the weighting factor for phase p of DS_j of the shortened Type 1 test procedure

and

$$K_{p,1} = \frac{\Delta E_{REESS,p,1}}{UBE_{STP}} \text{ and } K_{p,2} = 1 - K_{p,1}$$

where:

ΔE_{REESS,p,1} is the electric energy change of all REESSs during the first phase p of DS₁ of the shortened Type 1 test procedure, Wh.

4.4.2.2. Determination of the pure electric ranges when the consecutive cycle Type 1 test procedure is applied

- 4.4.2.2.1. The pure electric range for the applicable WLTP test cycle PER_{WLTP} for PEVs shall be calculated from the Type 1 test as described in paragraph 3.4.4.1. of this annex using the following equations:

$$PER_{WLTP} = \frac{UBE_{CCP}}{EC_{DC,WLTC}}$$

where:

UBE_{CCP} is the usable REESS energy determined from the beginning of the consecutive cycle Type 1 test procedure until the break-off criterion according to paragraph 3.4.4.1.3. of this annex is reached, Wh;

$EC_{DC,WLTC}$ is the electric energy consumption for the applicable WLTP test cycle determined from completely driven applicable WLTP test cycles of the consecutive cycle Type 1 test procedure, Wh/km;

and

$$UBE_{CCP} = \sum_{j=1}^k \Delta E_{REESS,j}$$

where:

$\Delta E_{REESS,j}$ is the electric energy change of all REESSs during phase j of the consecutive cycle Type 1 test procedure, Wh;

j is the index number of the phase;

k is the number of phases driven from the beginning up to and including the phase where the break-off criterion is reached;

and:

$$EC_{DC,WLTC} = \sum_{j=1}^{n_{WLTC}} EC_{DC,WLTC,j} \times K_{WLTC,j}$$

where:

$EC_{DC,WLTC,j}$ is the electric energy consumption for the applicable WLTP test cycle j of the consecutive cycle Type 1 test procedure according to paragraph 4.3. of this annex, Wh/km;

$K_{WLTC,j}$ is the weighting factor for the applicable WLTP test cycle j of the consecutive cycle Type 1 test procedure;

j is the index number of the applicable WLTP test cycle;

n_{WLTC} is the whole number of complete applicable WLTP test cycles driven;

and

$$K_{WLTC,1} = \frac{\Delta E_{REESS,WLTC,1}}{UBE_{CCP}} \text{ and } K_{WLTC,j} = \frac{1 - K_{WLTC,1}}{n_{WLTC} - 1} \text{ for } j = 2 \dots n_{WLTC}$$

where:

$\Delta E_{REESS,WLTC,1}$ is the electric energy change of all REESSs during the first applicable WLTP test cycle of the consecutive Type 1 test cycle procedure, Wh.

- 4.4.2.2.2. Pure Electric Range city (PER_{city}) (if applicable)

The pure electric range for the WLTP city test cycle PER_{city} for PEVs shall be calculated from the Type 1 test as described in paragraph 3.4.4.1. of this annex using the following equations:

$$PER_{city} = \frac{UBE_{CCP}}{EC_{DC,city}}$$

where:

PER_{city} is the pure electric range for the WLTP city test cycle for PEVs, km;

UBE_{CCP} is the usable REESS energy according to paragraph 4.4.2.2.1. of this annex, Wh;

$EC_{DC,city}$ is the electric energy consumption for the applicable WLTP city test cycle determined from completely driven applicable WLTP city test cycles of the consecutive cycle Type 1 test procedure, Wh/km;

and

$$EC_{DC,city} = \sum_{j=1}^{n_{city}} EC_{DC,city,j} \times K_{city,j}$$

where:

$EC_{DC,city,j}$ is the electric energy consumption for the applicable WLTP city test cycle j of the consecutive cycle Type 1 test procedure according to paragraph 4.3. of this annex, Wh/km;

$K_{city,j}$ is the weighting factor for the applicable WLTP city test cycle j of the consecutive cycle Type 1 test procedure;

j is the index number of the applicable WLTP city test cycle;

n_{city} is the whole number of complete applicable WLTP city test cycles driven;

and

$$K_{city,1} = \frac{\Delta E_{REESS,city,1}}{UBE_{CCP}} \text{ and } K_{city,j} = \frac{1 - K_{city,1}}{n_{city} - 1} \text{ for } j = 2 \dots n_{city}$$

where:

$\Delta E_{REESS,city,1}$ is the electric energy change of all REESSs during the first applicable WLTP city test cycle of the consecutive cycle Type 1 test procedure, Wh.

4.4.2.2.3. The phase-specific pure electric range PER_p for PEVs shall be calculated from the Type 1 test as described in paragraph 3.4.4.1. of this annex using the following equations:

$$PER_p = \frac{UBE_{CCP}}{EC_{DC,p}}$$

where:

PER_p is the phase-specific pure electric range for PEVs, km;

UBE_{CCP} is the usable REESS energy according to paragraph 4.4.2.2.1. of this annex, Wh;

$EC_{DC,p}$ is the electric energy consumption for the considered phase p determined from completely driven phases p of the consecutive cycle Type 1 test procedure, Wh/km;

and

$$EC_{DC,p} = \sum_{j=1}^{n_p} EC_{DC,p,j} \times K_{p,j}$$

where:

$EC_{DC,p,j}$ is the j^{th} electric energy consumption for the considered phase p of the consecutive cycle Type 1 test procedure according to paragraph 4.3. of this annex, Wh/km;

$K_{p,j}$ is the j^{th} weighting factor for the considered phase p of the consecutive cycle Type 1 test procedure;

j is the index number of the considered phase p ;

n_p is the whole number of complete WLTC phases p driven;

and

$$K_{p,1} = \frac{\Delta E_{\text{REESS},p,1}}{U_{\text{BECCP}}} \text{ and } K_{p,j} = \frac{1 - K_{p,1}}{n_p - 1} \text{ for } j = 2 \dots n_p$$

where:

$\Delta E_{\text{REESS},p,1}$ is the electric energy change of all REESSs during the first driven phase p during the consecutive cycle Type 1 test procedure, Wh.

4.4.3. Charge-depleting cycle range for OVC-HEVs

The charge-depleting cycle range R_{CDC} shall be determined from the charge-depleting Type 1 test described in paragraph 3.2.4.3. of this annex as part of the Option 1 test sequence and is referenced in paragraph 3.2.6.1. of this annex as part of the Option 3 test sequence. The R_{CDC} is the distance driven from the beginning of the charge-depleting Type 1 test to the end of the transition cycle according to paragraph 3.2.4.4. of this annex.

4.4.4. Equivalent all-electric range for OVC-HEVs

4.4.4.1. Determination of cycle-specific equivalent all-electric range

The cycle-specific equivalent all-electric range shall be calculated using the following equation:

$$\text{EAER} = \left(\frac{M_{\text{CO}_2,\text{CS,declared}} - M_{\text{CO}_2,\text{CD,avg}} \times \frac{M_{\text{CO}_2,\text{CD,declared}}}{M_{\text{CO}_2,\text{CD,ave}}}}{M_{\text{CO}_2,\text{CS,declared}}} \right) \times R_{\text{CDC}}$$

where:

EAER is the cycle-specific equivalent all-electric range, km;

$M_{\text{CO}_2,\text{CS,declared}}$ is the declared charge-sustaining CO_2 mass emission according to Table A8/5, step No. 7, g/km;

$M_{\text{CO}_2,\text{CD,avg}}$ is the arithmetic average charge-depleting CO_2 mass emission according to the equation below, g/km;

$M_{\text{CO}_2,\text{CD,declared}}$ is the declared charge-depleting CO_2 mass emission according to Table A8/8, step no. 14, g/km;

$M_{\text{CO}_2,\text{CD,ave}}$ is the average charge-depleting CO_2 mass emission according to Table A8/8, step no. 13, g/km;

R_{CDC} is the charge-depleting cycle range according to paragraph 4.4.2. of this annex, km;

and

$$M_{\text{CO}_2,\text{CD,avg}} = \frac{\sum_{j=1}^k (M_{\text{CO}_2,\text{CD},j} \times d_j)}{\sum_{j=1}^k d_j}$$

where:

$M_{\text{CO}_2,\text{CD,avg}}$ is the arithmetic average charge-depleting CO_2 mass emission, g/km. In the case of more than one charge-depleting test, the additional average of each test shall be calculated;

- $M_{CO_2,CD,j}$ is the CO₂ mass emission determined according to paragraph 3.2.1. of Annex B7 of phase j of the charge-depleting Type 1 test, g/km;
- d_j is the distance driven in phase j of the charge-depleting Type 1 test, km;
- j is the index number of the considered phase;
- k is the number of phases driven up to the end of the transition cycle n according to paragraph 3.2.4.4. of this annex.

4.4.4.2. Determination of the phase-specific equivalent all-electric range

The phase-specific equivalent all-electric range shall be calculated using the following equation:

$$EAER_p = \left(\frac{M_{CO_2,CS,p} - M_{CO_2,CD,avg,p} \times \frac{M_{CO_2,CD,declared}}{M_{CO_2,CD,ave}}}{M_{CO_2,CS,p}} \right) \times \frac{\sum_{j=1}^k \Delta E_{REESS,j}}{EC_{DC,CD,p}}$$

where:

- $EAER_p$ is the phase-specific equivalent all-electric range for the considered phase p, km;
- $M_{CO_2,CS,p}$ is the phase-specific CO₂ mass emission from the charge-sustaining Type 1 test for the considered phase p according to Table A8/5, step No. 7, g/km;
- $M_{CO_2,CD,declared}$ is the declared charge-depleting CO₂ mass emission according to Table A8/8, step no. 14, g/km;
- $M_{CO_2,CD,ave}$ is the average charge-depleting CO₂ mass emission according to Table A8/8, step no. 13, g/km;
- $\Delta E_{REESS,j}$ are the electric energy changes of all REESSs during the considered phase j, Wh. In the case of more than one charge-depleting test, the additional average of each test shall be calculated;
- $EC_{DC,CD,p}$ is the electric energy consumption over the considered phase p based on the REESS depletion, Wh/km;
- j is the index number of the considered phase;
- k is the number of phases driven up to the end of the transition cycle n according to paragraph 3.2.4.4 of this annex;

and

$$M_{CO_2,CD,avg,p} = \frac{\sum_{c=1}^{n_c} (M_{CO_2,CD,p,c} \times d_{p,c})}{\sum_{c=1}^{n_c} d_{p,c}}$$

where:

- $M_{CO_2,CD,avg,p}$ is the arithmetic average charge-depleting CO₂ mass emission for the considered phase p, g/km. In the case of more than one charge-depleting test, the additional average of each test shall be calculated;
- $M_{CO_2,CD,p,c}$ is the CO₂ mass emission determined according to paragraph 3.2.1. of Annex B7 of phase p in cycle c of the charge-depleting Type 1 test, g/km;

- $d_{p,c}$ is the distance driven in the considered phase p of cycle c of the charge-depleting Type 1 test, km;
- c is the index number of the considered applicable WLTP test cycle;
- p is the index of the individual phase within the applicable WLTP test cycle;
- n_c is the number of applicable WLTP test cycles driven up to the end of the transition cycle n according to paragraph 3.2.4.4. of this annex;

and:

$$EC_{DC,CD,p} = \frac{\sum_{c=1}^{n_c} EC_{DC,CD,p,c} \times d_{p,c}}{\sum_{c=1}^{n_c} d_{p,c}}$$

where:

- $EC_{DC,CD,p}$ is the electric energy consumption of the considered phase p based on the REESS depletion of the charge-depleting Type 1 test, Wh/km. In the case of more than one charge-depleting test, the additional average of each test shall be calculated;
- $EC_{DC,CD,p,c}$ is the electric energy consumption of the considered phase p of cycle c based on the REESS depletion of the charge-depleting Type 1 test according to paragraph 4.3. of this annex, Wh/km;
- $d_{p,c}$ is the distance driven in the considered phase p of cycle c of the charge-depleting Type 1 test, km;
- c is the index number of the considered applicable WLTP test cycle;
- p is the index of the individual phase within the applicable WLTP test cycle;
- n_c is the number of applicable WLTP test cycles driven up to the end of the transition cycle n according to paragraph 3.2.4.4. of this annex.

For the 4-phase WLTP;The considered phase shall be the low phase, medium phase, high phase, extra high phase, and the city driving cycle.

For the 3-phase WLTP;The considered phase shall be the low phase, medium phase and high phase.

4.4.5. Actual charge-depleting range for OVC-HEVs

The actual charge-depleting range shall be calculated using the following equation:

$$R_{CDA} = \sum_{c=1}^{n-1} d_c + \left(\frac{M_{CO_2,CS} - M_{CO_2,n,cycle}}{M_{CO_2,CS} - M_{CO_2,CD,avg,n-1}} \right) \times d_n$$

where:

- R_{CDA} is the actual charge-depleting range, km;
- $M_{CO_2,CS}$ is the charge-sustaining CO₂ mass emission according to Table A8/5, step No. 7, g/km;
- $M_{CO_2,n,cycle}$ is the CO₂ mass emission of the applicable WLTP test cycle n of the charge-depleting Type 1 test, g/km;
- $M_{CO_2,CD,avg,n-1}$ is the arithmetic average CO₂ mass emission of the charge-depleting Type 1 test from the beginning up to and including

	the applicable WLTP test cycle (n-1), g/km;
d_c	is the distance driven in the applicable WLTP test cycle c of the charge-depleting Type 1 test, km;
d_n	is the distance driven in the applicable WLTP test cycle n of the charge-depleting Type 1 test, km;
c	is the index number of the considered applicable WLTP test cycle;
n	is the number of applicable WLTP test cycles driven including the transition cycle according to paragraph 3.2.4.4. of this annex;

and:

$$M_{CO_2,CD,avg,n-1} = \frac{\sum_{c=1}^{n-1} (M_{CO_2,CD,c} \times d_c)}{\sum_{c=1}^{n-1} d_c}$$

where:

$M_{CO_2,CD,avg,n-1}$	is the arithmetic average CO ₂ mass emission of the charge-depleting Type 1 test from the beginning up to and including the applicable WLTP test cycle (n-1), g/km;
$M_{CO_2,CD,c}$	is the CO ₂ mass emission determined according to paragraph 3.2.1. of Annex B7 of the applicable WLTP test cycle c of the charge-depleting Type 1 test, g/km;
d_c	is the distance driven in the applicable WLTP test cycle c of the charge-depleting Type 1 test, km;
c	is the index number of the considered applicable WLTP test cycle;
n	is the number of applicable WLTP test cycles driven including the transition cycle according to paragraph 3.2.4.4. of this annex.

4.5. Interpolation of individual vehicle values

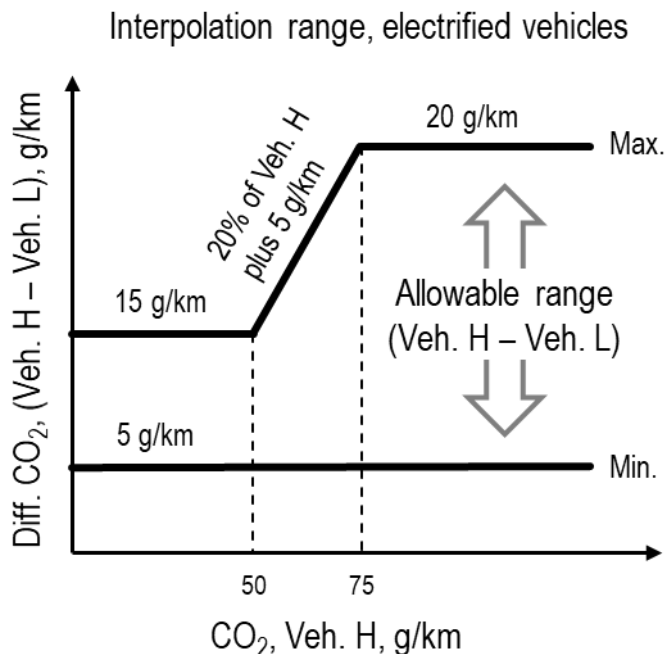
4.5.1.1. Interpolation range for NOVC- HEVs and OVC-HEVs

4.5.1.1.1. The interpolation method shall only be used if the difference in charge-sustaining CO₂ over the applicable cycle resulting from step 8 of Table A8/5 in Annex B8 between test vehicles L and H is between a minimum of 5 g/km and a maximum defined in paragraph 4.5.1.1.2. of this annex.

4.5.1.1.2. The maximum difference in charge-sustaining CO₂ allowed over the applicable cycle resulting from the calculation of the charge-sustaining CO₂ mass emission $M_{CO_2,CS}$ from step 8 in Table A8/5 of Annex B8 between test vehicles L and H shall be 20 per cent of the charge-sustaining CO₂ emissions from vehicle H plus 5 g/km, but shall be at least 15 g/km and not exceed 20 g/km. See Figure A8/3. This restriction does not apply for the application of a road load matrix family or when the calculation of the road load of vehicles L and H is based on the default road load.

Figure A8/3

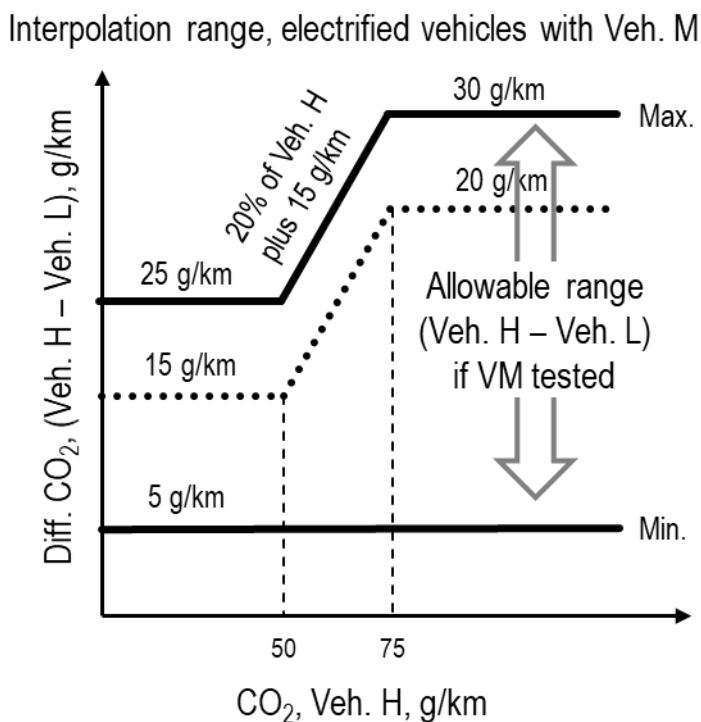
Interpolation range between vehicle H and vehicle L applied to EVs



4.5.1.1.3. The allowed interpolation range defined in paragraph 4.5.1.1.2. of this annex may be increased by 10 g/km charge-sustaining CO₂ if a vehicle M is tested within that family and the conditions according to paragraph 4.5.1.1.5. of this annex are fulfilled. This increase is allowed only once within an interpolation family. See Figure A8/4.

Figure A8/4

Interpolation range for EVs with vehicle M



4.5.1.1.4. At the request of the manufacturer and with approval of the responsible authority, the application of the interpolation method on individual vehicle values within a family may be extended if the maximum extrapolation of an individual vehicle (Step 9 in Table A8/5) is not more than 3 g/km above the

charge-sustaining CO₂ mass emission of vehicle H (Step 8 in Table A8/5) and/or is not more than 3 g/km below the charge-sustaining CO₂ mass emission of vehicle L (Step 8 in Table A8/5). This extrapolation is valid only within the absolute boundaries of the interpolation range specified in this paragraph.

For the application of a road load matrix family, or when the calculation of the road load of vehicles L and H is based on the default road load, extrapolation is not permitted.

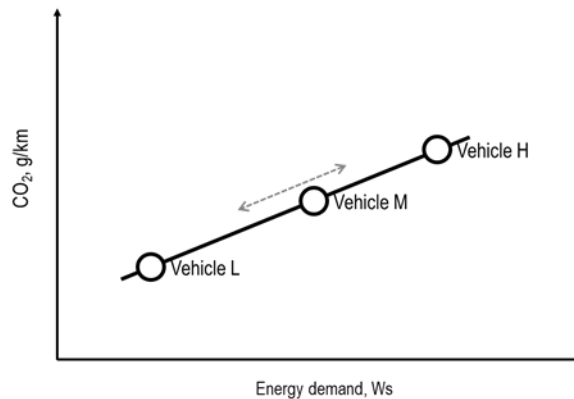
4.5.1.1.5. Vehicle M

Vehicle M is a vehicle within the interpolation family between vehicles L and H with a cycle energy demand which is preferably closest to the average of vehicles L and H.

The limits of the selection of vehicle M (see Figure A8/5) are such that neither the difference in CO₂ mass emission between vehicles H and M nor the difference in charge-sustaining CO₂ mass emission between vehicles M and L is higher than the allowed charge-sustaining CO₂ range according to paragraph 4.5.1.1.2. of this annex. The defined road load coefficients and the defined test mass shall be recorded.

Figure A8/5

Limits for the selection of vehicle M



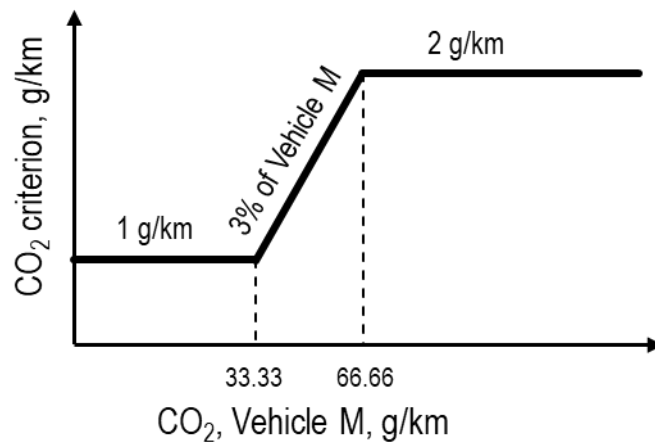
The linearity of charge-sustaining CO₂ mass emission for vehicle M shall be verified against the linearly interpolated charge-sustaining CO₂ mass emission between vehicle L and H over the applicable cycle by using the corrected measured values referring to step 6 $M_{CO_2,CS,c,6}$ of Table A8/5 of this annex.

The linearity criterion for vehicle M shall be considered fulfilled if the charge-sustaining CO₂ mass emission of vehicle M over the applicable WLTC minus the charge-sustaining CO₂ mass emission derived by interpolation is less than 2 g/km or 3 per cent of the interpolated value, whichever value is less, but at least 1 g/km. See Figure A8/6.

Figure A8/6

Linearity criterion for vehicle M

Tolerance, Vehicle M measured vs. calculated



If the linearity criterion is fulfilled, the interpolation method shall be applicable for all individual vehicle values between vehicles L and H within the interpolation family.

If the linearity criterion is not fulfilled, the interpolation family shall be split into two sub-families for vehicles with a cycle energy demand between vehicles L and M, and vehicles with a cycle energy demand between vehicles M and H. In such a case, the final values of e.g. the charge-sustaining CO₂ mass emissions of vehicle M shall be determined according to the same process as for vehicles L or H. See Table A8/5, Table A8/6, Table A8/8 and Table A8/9.

For vehicles with a cycle energy demand between that of vehicles L and M, each parameter of vehicle H necessary for the application of the interpolation method on individual OVC-HEV and NOVC-HEV values, shall be substituted by the corresponding parameter of vehicle M.

For vehicles with a cycle energy demand between that of vehicles M and H, each parameter of vehicle L that is necessary for the application of the interpolation method on individual OVC-HEV and NOVC-HEV values shall be substituted by the corresponding parameter of vehicle M.

4.5.2. Calculation of energy demand per period

The energy demand $E_{k,p}$ and distance driven $d_{c,p}$ per period p applicable for individual vehicles in the interpolation family shall be calculated according to the procedure in paragraph 5. of Annex B7, for the sets k of road load coefficients and masses according to paragraph 3.2.3.2.3. of Annex B7.

4.5.3. Calculation of the interpolation coefficient for individual vehicles $K_{ind,p}$

The interpolation coefficient $K_{ind,p}$ per period shall be calculated for each considered period p using the following equation:

$$K_{ind,p} = \frac{E_{3,p} - E_{1,p}}{E_{2,p} - E_{1,p}}$$

where:

$K_{ind,p}$ is the interpolation coefficient for the considered individual vehicle for period p ;

$E_{1,p}$ is the energy demand for the considered period for vehicle L according to paragraph 5. of Annex B7, W_s ;

- $E_{2,p}$ is the energy demand for the considered period for vehicle H according to paragraph 5. of Annex B7, Ws;
- $E_{3,p}$ is the energy demand for the considered period for the individual vehicle according to paragraph 5. of Annex B7, Ws;
- p is the index of the individual period within the applicable test cycle.

In the case that the considered period p is the applicable WLTP test cycle, $K_{ind,p}$ is named K_{ind} .

4.5.4. This paragraph is applicable only for 4-phase WLTP test

Interpolation of the CO₂ mass emission for individual vehicles

4.5.4.1. Individual charge-sustaining CO₂ mass emission for OVC-HEVs and NOVC-HEVs

The charge-sustaining CO₂ mass emission for an individual vehicle shall be calculated using the following equation:

$$M_{CO_2-ind,CS,p} = M_{CO_2-L,CS,p} + K_{ind,p} \times (M_{CO_2-H,CS,p} - M_{CO_2-L,CS,p})$$

where:

$M_{CO_2-ind,CS,p}$ is the charge-sustaining CO₂ mass emission for an individual vehicle of the considered period p according to Table A8/5, step No. 9, g/km;

$M_{CO_2-L,CS,p}$ is the charge-sustaining CO₂ mass emission for vehicle L of the considered period p according to Table A8/5, step No. 8, g/km;

$M_{CO_2-H,CS,p}$ is the charge-sustaining CO₂ mass emission for vehicle H of the considered period p according to Table A8/5, step No. 8, g/km;

$K_{ind,p}$ is the interpolation coefficient for the considered individual vehicle for period p ;

p is the index of the individual period within the applicable WLTP test cycle.

The considered periods shall be the low phase, medium phase, high phase, extra high phase and the applicable WLTP test cycle.

4.5.4.2. Individual utility factor-weighted charge-depleting CO₂ mass emission for OVC-HEVs

The utility factor-weighted charge-depleting CO₂ mass emission for an individual vehicle shall be calculated using the following equation:

$$M_{CO_2-ind,CD} = M_{CO_2-L,CD} + K_{ind} \times (M_{CO_2-H,CD} - M_{CO_2-L,CD})$$

where:

$M_{CO_2-ind,CD}$ is the utility factor-weighted charge-depleting CO₂ mass emission for an individual vehicle, g/km;

$M_{CO_2-L,CD}$ is the utility factor-weighted charge-depleting CO₂ mass emission for vehicle L, g/km;

$M_{CO_2-H,CD}$ is the utility factor-weighted charge-depleting CO₂ mass emission for vehicle H, g/km;

K_{ind} is the interpolation coefficient for the considered individual vehicle for the applicable WLTP test cycle.

4.5.4.3. Individual utility factor-weighted CO₂ mass emission for OVC-HEVs

The utility factor-weighted CO₂ mass emission for an individual vehicle shall be calculated using the following equation:

$$M_{\text{CO}_2\text{-ind,weighted}} = M_{\text{CO}_2\text{-L,weighted}} + K_{\text{ind}} \times (M_{\text{CO}_2\text{-H,weighted}} - M_{\text{CO}_2\text{-L,weighted}})$$

where:

$M_{\text{CO}_2\text{-ind,weighted}}$ is the utility factor-weighted CO₂ mass emission for an individual vehicle, g/km;

$M_{\text{CO}_2\text{-L,weighted}}$ is the utility factor-weighted CO₂ mass emission for vehicle L, g/km;

$M_{\text{CO}_2\text{-H,weighted}}$ is the utility factor-weighted CO₂ mass emission for vehicle H, g/km;

K_{ind} is the interpolation coefficient for the considered individual vehicle for the applicable WLTP test cycle.

4.5.5. Interpolation of the fuel consumption and fuel efficiency for individual vehicles

4.5.5.1. Individual charge-sustaining fuel consumption and fuel efficiency for OVC-HEVs and NOVC-HEVs

4.5.5.1.1. This paragraph is applicable only for 4-phase WLTP test

Individual charge-sustaining fuel consumption for OVC-HEVs and NOVC-HEVs

The charge-sustaining fuel consumption for an individual vehicle shall be calculated using the following equation:

$$FC_{\text{ind,CS,p}} = FC_{\text{L,CS,p}} + K_{\text{ind,p}} \times (FC_{\text{H,CS,p}} - FC_{\text{L,CS,p}})$$

where:

$FC_{\text{ind,CS,p}}$ is the charge-sustaining fuel consumption for an individual vehicle of the considered period p according to Table A8/6, step No. 3, l/100 km;

$FC_{\text{L,CS,p}}$ is the charge-sustaining fuel consumption for vehicle L of the considered period p according to Table A8/6, step No. 2, l/100 km;

$FC_{\text{H,CS,p}}$ is the charge-sustaining fuel consumption for vehicle H of the considered period p according to Table A8/6, step No. 2, l/100 km;

$K_{\text{ind,p}}$ is the interpolation coefficient for the considered individual vehicle for period p;

p is the index of the individual period within the applicable WLTP test cycle.

The considered periods shall be the low phase, medium phase, high phase, extra high phase, and the applicable WLTP test cycle.

4.5.5.1.2. This paragraph is only applicable for the 3-phase WLTP:

Individual charge-sustaining fuel efficiency for OVC-HEVs and NOVC-HEVs

The charge-sustaining fuel efficiency for an individual vehicle shall be calculated using the following equation:

$$FE_{\text{ind,CS,p}} = \frac{1}{1/FE_{\text{L,CS,p}} + K_{\text{ind,p}} \times (1/FE_{\text{H,CS,p}} - 1/FE_{\text{L,CS,p}})}$$

where:

$FE_{ind,CS,p}$	is the charge-sustaining fuel consumption for an individual vehicle of the considered period p according to Table A8/6, step No. 3, km/l;
$FE_{L,CS,p}$	is the charge-sustaining fuel consumption for vehicle L of the considered period p according to Table A8/6, step No. 2, km/l;
$FE_{H,CS,p}$	is the charge-sustaining fuel consumption for vehicle H of the considered period p according to Table A8/6, step No. 2, km/l;
$K_{ind,p}$	is the interpolation coefficient for the considered individual vehicle for period p;
p	is the index of the individual period within the applicable WLTP test cycle.

The considered periods shall be the low phase, medium phase, high phase and the applicable WLTP test cycle. 4.5.5.2. Individual charge depleting fuel consumption for OVC-HEVs

For 4-phase WLTP test

The utility factor-weighted charge-depleting fuel consumption for an individual vehicle shall be calculated using the following equation:

$$FC_{ind,CD} = FC_{L,CD} + K_{ind} \times (FC_{H,CD} - FC_{L,CD})$$

where:

$FC_{ind,CD}$	is the utility factor-weighted charge-depleting fuel consumption for an individual vehicle, l/100 km;
$FC_{L,CD}$	is the utility factor-weighted charge-depleting fuel consumption for vehicle L, l/100 km;
$FC_{H,CD}$	is the utility factor-weighted charge-depleting fuel consumption for vehicle H, l/100 km;
K_{ind}	is the interpolation coefficient for the considered individual vehicle for the applicable WLTP test cycle.

For 3-phase WLTP test

The charge-depleting fuel efficiency for an individual vehicle shall be calculated using the following equation:

$$FE_{ind,CD} = \frac{1}{1/FE_{L,CD} + K_{ind,p} \times (1/FE_{H,CD} - 1/FE_{L,CD})}$$

where:

$FE_{ind,CD}$	is the charge-depleting fuel efficiency for an individual vehicle, km/l;
$FE_{L,CD}$	is the charge-depleting fuel efficiency for vehicle L, km/l;
$FE_{H,CD}$	is the charge-depleting fuel efficiency for vehicle H, km/l;
K_{ind}	is the interpolation coefficient for the considered individual vehicle for the applicable WLTP test cycle.

4.5.5.3. This paragraph is applicable only for 4-phase WLTP test

Individual utility factor-weighted fuel consumption for OVC-HEVs

The utility factor-weighted fuel consumption for an individual vehicle shall be calculated using the following equation:

$$FC_{ind,weighted} = FC_{L,weighted} + K_{ind} \times (FC_{H,weighted} - FC_{L,weighted})$$

where:

- $FC_{ind,weighted}$ is the utility factor-weighted fuel consumption for an individual vehicle, l/100 km;
- $FC_{L,weighted}$ is the utility factor-weighted fuel consumption for vehicle L, l/100 km;
- $FC_{H,weighted}$ is the utility factor-weighted fuel consumption for vehicle H, l/100 km;
- K_{ind} is the interpolation coefficient for the considered individual vehicle for the applicable WLTP test cycle.

4.5.6. Interpolation of electric energy consumption for individual vehicles

4.5.6.1. This paragraph is applicable only for 4-phase WLTP test

Individual utility factor-weighted charge-depleting electric energy consumption based on the recharged electric energy from the mains for OVC-HEVs

The utility factor-weighted charge-depleting electric energy consumption based on the recharged electric energy from for an individual vehicle shall be calculated using the following equation:

$$EC_{AC-ind,CD} = EC_{AC-L,CD} + K_{ind} \times (EC_{AC-H,CD} - EC_{AC-L,CD})$$

where:

- $EC_{AC-ind,CD}$ is the utility factor-weighted charge-depleting electric energy consumption based on the recharged electric energy from the mains for an individual vehicle, Wh/km;
- $EC_{AC-L,CD}$ is the utility factor-weighted charge-depleting electric energy consumption based on the recharged electric energy from the mains for vehicle L, Wh/km;
- $EC_{AC-H,CD}$ is the utility factor-weighted charge-depleting electric energy consumption based on the recharged electric energy from the mains for vehicle H, Wh/km;
- K_{ind} is the interpolation coefficient for the considered individual vehicle for the applicable WLTP test cycle.

4.5.6.2. This paragraph is applicable only for 4-phase WLTP test

Individual utility factor-weighted electric energy consumption based on the recharged electric energy from the mains for OVC-HEVs

The utility factor-weighted electric energy consumption based on the recharged electric energy from the mains for an individual vehicle shall be calculated using the following equation:

$$EC_{AC-ind,weighted} = EC_{AC-L,weighted} + K_{ind} \times (EC_{AC-H,weighted} - EC_{AC-L,weighted})$$

where:

- $EC_{AC-ind,weighted}$ is the utility factor weighted electric energy consumption based on the recharged electric energy from the mains for an individual vehicle, Wh/km;
- $EC_{AC-L,weighted}$ is the utility factor weighted electric energy consumption based on the recharged electric energy from the mains for vehicle L, Wh/km;

- $EC_{AC-H,weighted}$ is the utility factor weighted electric energy consumption based on the recharged electric energy from the mains for vehicle H, Wh/km;
- K_{ind} is the interpolation coefficient for the considered individual vehicle for the applicable WLTP test cycle.

4.5.6.3. Individual electric energy consumption for OVC-HEVs and PEVs

The electric energy consumption for an individual vehicle according to paragraph 4.3.3. of this annex in the case of OVC-HEVs and according to paragraph 4.3.4. of this annex in the case of PEVs shall be calculated using the following equation:

$$EC_{ind,p} = EC_{L,p} + K_{ind,p} \times (EC_{H,p} - EC_{L,p})$$

where:

- $EC_{ind,p}$ is the electric energy consumption for an individual vehicle for the considered period p, Wh/km;
- $EC_{L,p}$ is the electric energy consumption for vehicle L for the considered period p, Wh/km;
- $EC_{H,p}$ is the electric energy consumption for vehicle H for the considered period p, Wh/km;
- $K_{ind,p}$ is the interpolation coefficient for the considered individual vehicle for period p;
- p is the index of the individual period within the applicable test cycle.

For the 4-phase WLTP;

The considered periods shall be the low phase, medium phase, high phase, extra high phase, the applicable WLTP city test cycle and the applicable WLTP test cycle.

For the 3-phase WLTP ;

The considered periods shall be the low phase, medium phase, high phase and the applicable WLTP test cycle.

4.5.7. Interpolation of electric ranges for individual vehicles

4.5.7.1. Individual all-electric range for OVC-HEVs

If the following criterion

$$\left| \frac{AER_L}{R_{CDA,L}} - \frac{AER_H}{R_{CDA,H}} \right| \leq 0.1$$

where:

- AER_L is the all-electric range of vehicle L for the applicable WLTP test cycle, km;
- AER_H is the all-electric range of vehicle H for the applicable WLTP test cycle, km;
- $R_{CDA,L}$ is the actual charge-depleting range of vehicle L, km;
- $R_{CDA,H}$ is the actual charge-depleting range of vehicle H, km;

is fulfilled, the all-electric range for an individual vehicle shall be calculated using the following equation:

$$AER_{ind,p} = AER_{L,p} + K_{ind,p} \times (AER_{H,p} - AER_{L,p})$$

where:

$AER_{ind,p}$	is the all-electric range for an individual vehicle for the considered period p, km;
$AER_{L,p}$	is the all-electric range for vehicle L for the considered period p, km;
$AER_{H,p}$	is the all-electric range for vehicle H for the considered period p, km;
$K_{ind,p}$	is the interpolation coefficient for the considered individual vehicle for period p;
p	is the index of the individual period within the applicable test cycle.

For the 4-phase WLTP; The considered periods shall be the applicable WLTP city test cycle and the applicable WLTP test cycle.

For the 3-phase WLTP; The considered periods shall be the applicable WLTP test cycle.

If the criterion defined in this paragraph is not fulfilled, the AER determined for vehicle H is applicable to all vehicles within the interpolation family.

4.5.7.2. Individual pure electric range for PEVs

The pure electric range for an individual vehicle shall be calculated using the following equation:

$$PER_{ind,p} = PER_{L,p} + K_{ind,p} \times (PER_{H,p} - PER_{L,p})$$

where:

$PER_{ind,p}$	is the pure electric range for an individual vehicle for the considered period p, km;
$PER_{L,p}$	is the pure electric range for vehicle L for the considered period p, km;
$PER_{H,p}$	is the pure electric range for vehicle H for the considered period p, km;
$K_{ind,p}$	is the interpolation coefficient for the considered individual vehicle for period p;
p	is the index of the individual period within the applicable test cycle.

For the 4-phase WLTP only;

The considered periods shall be the low phase, medium phase, high phase, extra high phase, the applicable WLTP city test cycle and the applicable WLTP test cycle.

For the 3-phase WLTP only;

The considered periods shall be the applicable WLTP test cycle.

4.5.7.3. Individual equivalent all-electric range for OVC-HEVs

The equivalent all-electric range for an individual vehicle shall be calculated using the following equation:

$$EAER_{ind,p} = EAER_{L,p} + K_{ind,p} \times (EAER_{H,p} - EAER_{L,p})$$

where:

$EAER_{ind,p}$	is the equivalent all-electric range for an individual vehicle for the considered period p, km;
----------------	---

$EAER_{L,p}$	is the equivalent all-electric range for vehicle L for the considered period p, km;
$EAER_{H,p}$	is the equivalent all-electric range for vehicle H for the considered period p, km;
$K_{ind,p}$	is the interpolation coefficient for the considered individual vehicle for period p;
p	is the index of the individual period within the applicable test cycle.

For the 4-phase WLTP;

The considered periods shall be the low phase, medium phase, high phase, extra high phase, the applicable WLTP city test cycle and the applicable WLTP test cycle.

For the 3-phase WLTP only;

The considered periods shall be the applicable WLTP test cycle.

4.5.8. Adjustment of values

The individual EAER value determined in accordance with paragraph 4.5.7.3. of this annex may be decreased by the OEM. In such cases:

The EAER phase values shall be decreased by the ratio of the decreased EAER value divided by the calculated EAER value. This shall not compensate for technical elements that would effectively require a vehicle to be excluded from the interpolation family.

4.6. Stepwise procedure for calculating the final test results of OVC-HEVs

In addition to the stepwise procedure for calculating the final charge-sustaining test results for gaseous emission compounds according to paragraph 4.1.1.1. of this annex and for fuel consumption and fuel efficiency according to paragraph 4.2.1.1. of this annex, paragraphs 4.6.1. and 4.6.2. of this annex describe the stepwise calculation of the final charge-depleting as well as the final charge-sustaining and charge-depleting weighted test results.

4.6.1. Stepwise procedure for calculating the final test results of the charge-depleting Type 1 test for OVC-HEVs

The results shall be calculated in the order described in Table A8/8. All applicable results in the column "Output" shall be recorded. The column "Process" describes the paragraphs to be used for calculation or contains additional calculations.

For the purpose of Table A8/8, the following nomenclature within the equations and results is used:

c	complete applicable test cycle;
p	every applicable cycle phase; for the purpose of the city test cycle calculation (as applicable), p shall represent the city driving cycle;
i	applicable criteria emission component;
CS	charge-sustaining;
CO ₂	CO ₂ mass emission.

Table A8/8

Calculation of final charge-depleting values (FE applicable for results after 3 phases only)

<i>Step no.</i>	<i>Source</i>	<i>Input</i>	<i>Process</i>	<i>Output</i>
1	Annex B8	Charge-depleting test results	<p>Results measured according to Appendix 3 to this annex, pre-calculated according to paragraph 4.3. of this annex.</p> <p>Recharged electric energy according to paragraph 3.2.4.6. of this annex.</p> <p>Cycle energy according to paragraph 5. of Annex B7.</p> <p>CO₂ mass emission according to paragraph 3.2.1. of Annex B7.</p> <p>Mass of gaseous emission compound <i>i</i> according to paragraph 4.1.3.1. of Annex B8.</p> <p>All-electric range determined according to paragraph 4.4.1.1. of this annex.</p> <p>CO₂ mass emission K_{CO2} correction coefficient might be necessary according to Appendix 2 to this annex.</p> <p>Output is available for each test.</p> <p>In the case that the interpolation method is applied, the output (except of K_{CO2}) is available for vehicle H, L and, if applicable, M.</p>	$\Delta E_{REESS,j}$, Wh; d_j , km; E_{AC} , Wh; E_{cycle} , Ws; $M_{CO2,CD,j}$, g/km; $M_{i,CD,j}$, g/km; AER , km; K_{CO2} , (g/km)/(Wh/km).
	For results after 4 phases Annex B8		<p>Usable battery energy according to paragraph 4.4.1.2.2. of this annex.</p> <p>In the case that the applicable WLTC city test cycle was driven: all-electric range city according to paragraph 4.4.1.2.1. of this annex.</p> <p>Particle number emissions (if applicable) according to paragraph 4. of Annex B7.</p> <p>Particulate matter emissions according to paragraph 4. of Annex B7.</p>	$U_{BE_{city}}$, Wh; AER_{city} , km. $PN_{CD,j}$, particles per kilometer; $PM_{CD,e}$, mg/km;
2	Output step 1	$\Delta E_{REESS,j}$, Wh; E_{cycle} , Ws.	Calculation of relative electric energy change for each cycle according to paragraph 3.2.4.5.2. of this annex.	$REEC_i$.

			<p>Output is available for each test and each applicable WLTP test cycle.</p> <p>In the case that the interpolation method is applied, the output is available for vehicle H, L and, if applicable, M.</p>	
3	Output step 2	REEC _i .	<p>Determination of the transition and confirmation cycle according to paragraph 3.2.4.4. of this annex.</p> <p>In the case that more than one charge-depleting test is available for one vehicle, for the purpose of averaging, each test shall have the same transition cycle number n_{veh}.</p> <p>Determination of the charge-depleting cycle range according to paragraph 4.4.3. of this annex.</p> <p>Output is available for each test.</p> <p>In the case that the interpolation method is applied, the output is available for vehicle H, L and, if applicable, M.</p>	<p>n_{veh};</p> <p>R_{CDC}; km.</p>
4	Output step 3	n_{veh} ;	<p>In the case that the interpolation method is used, the transition cycle shall be determined for vehicle H, L and, if applicable, M.</p> <p>Check whether the interpolation criterion according to paragraph 6.3.2.2. (d) of this Regulation is fulfilled.</p>	<p>$n_{veh,L}$;</p> <p>$n_{veh,H}$;</p> <p>if applicable</p> <p>$n_{veh,M}$.</p>
For results after 4 phases 5	Output step 1	PM _{CD,c} , mg/km; PN _{CD,j} , particles per kilometer.	<p>Calculation of combined values for emissions for n_{veh} cycles; in the case of interpolation for $n_{veh,L}$ cycles for each vehicle.</p> <p>Output is available for each test.</p> <p>In the case that the interpolation method is applied, the output is available for vehicle H, L and, if applicable, M.</p>	<p>PM_{CD,c}, mg/km;</p> <p>PN_{CD,c}, particles per kilometer.</p>
For results after 4 phases 6	Output step 5	M _{i,CD,c} , g/km; PM _{CD,c} , mg/km; PN _{CD,c} , particles per kilometer.	<p>Emission averaging of tests for each applicable WLTP test cycle within the charge-depleting Type 1 test and check with the limits according to Table A6/2 of Annex B6.</p>	<p>M_{i,CD,c,ave}, g/km;</p> <p>PM_{CD,c,ave}, mg/km;</p> <p>PN_{CD,c,ave}, particles per kilometer.</p>
For results after 4 phases 7	Output step 1	ΔE _{REESS,j} , Wh; d _j , km; UBE _{city} , Wh.	<p>In the case that AER_{city} is derived from the Type 1 test by driving the applicable WLTP test cycles, the value shall be calculated according to paragraph 4.4.1.2.2. of this annex.</p> <p>In the case of more than one test, $n_{city,pe}$ shall be equal for each test.</p>	<p>AER_{city}, km;</p> <p>AER_{city,ave}, km.</p>

			<p>Output available for each test.</p> <p>Averaging of AER_{city}.</p> <p>In the case that the interpolation method is applied, the output is available for vehicle H, L and, if applicable, M.</p>	
For results after 4 phases 8	Output step 1	d_j , km;	<p>Phase-specific and cycle-specific UF calculation.</p> <p>Output is available for each test.</p> <p>In the case that the interpolation method is applied, the output is available for vehicle H, L and, if applicable, M.</p>	$UF_{phase,j}$; $UF_{cycle,c}$.
	Output step 3	n_{veh} ;		
	Output step 4	$n_{veh,L}$;		
For results after 4 phases 9	Output step 1	$\Delta E_{REESS,j}$, Wh; d_j , km; E_{AC} , Wh;	<p>Calculation of the electric energy consumption based on the recharged energy according to paragraphs 4.3.1. of this annex.</p> <p>In the case of interpolation, $n_{veh,L}$ cycles shall be used. Therefore, due to the required correction of the CO_2 mass emission, the electric energy consumption of the confirmation cycle and its phases shall be set to zero.</p> <p>Output is available for each test.</p> <p>In the case that the interpolation method is applied, the output is available for vehicle H, L and, if applicable, M.</p>	$EC_{AC,CD}$, Wh/km;
	Output step 3	n_{veh} ;		
	Output step 4	$n_{veh,L}$;		
	Output step 8	$UF_{phase,j}$;		
10	Output step 1	$M_{CO_2,CD,j}$, g/km; K_{CO_2} , (g/km)/(Wh/km); $\Delta E_{REESS,j}$, Wh; d_j , km; n_{veh} ; $n_{veh,L}$; $UF_{phase,j}$.	<p>Calculation of the charge-depleting CO_2 mass emission according to paragraph 4.1.2. of this annex.</p> <p>In the case that the interpolation method is applied, $n_{veh,L}$ cycles shall be used. With reference to paragraph 4.1.2. of this annex, the confirmation cycle shall be corrected according to Appendix 2 to this annex.</p> <p>Output is available for each test.</p> <p>In the case that the interpolation method is applied, the output is available for vehicle H, L and, if applicable, M.</p>	$M_{CO_2,CD}$, g/km;
	Output step 3	d_j , km;		
	Output step 4	n_{veh} ;		
	Output step 8	$n_{veh,L}$; $UF_{phase,j}$.		
11	Output step 1	$M_{CO_2,CD,j}$, g/km; $M_{i,CD,j}$, g/km; K_{CO_2} , (g/km)/(Wh/km).	<p>Calculation of the charge-depleting fuel consumption and fuel efficiency according to paragraph 4.2.2. of this annex.</p>	For results after 4 phases, $FC_{CD,j}$, l/100 km; FC_{CD} , l/100 km.

		$n_{veh};$ $n_{veh,L};$ $UF_{phase,j};$	In the case that the interpolation method is applied, $n_{veh,L}$ cycles shall be used. With reference to paragraph 4.1.2. of this annex, $M_{CO2,CD,j}$ of the confirmation cycle shall be corrected according to Appendix 2 to this annex.	For results after 3 phases, FE_{CD} , km/l.
	Output step 3	$n_{veh};$		
	Output step 4	$n_{veh,L};$		
	Output step 8	$UF_{phase,j};$	For results after 4 phases, the phase-specific fuel consumption $FC_{CD,j}$ shall be calculated using the corrected CO_2 mass emission according to paragraph 6. of Annex B7. Output is available for each test. In the case that the interpolation method is applied, the output is available for vehicle H, L and, if applicable, M.	
12	Output step 1	$\Delta E_{REESS,j}$, Wh; d_j , km;	If applicable, calculation of the electric energy consumption from the first applicable WLTP test cycle as described in Appendix 8, Paragraph 2.1. to this annex. Output is available for each test. In the case that the interpolation method is applied, the output is available for vehicle H, L and, if applicable, M.	$EC_{DC,CD,first}$, Wh/km
13	Output step 9	$EC_{AC,CD}$, Wh/km;	Averaging of tests for each vehicle.	If applicable: $EC_{DC,CD,first,ave}$, Wh/km
	Output step 10	$M_{CO2,CD}$, g/km;	In the case that the interpolation method is applied, the output is available for each vehicle H, L and, if applicable, M.	For results after 4 phases, $EC_{AC,CD,ave}$, Wh/km; $M_{CO2,CD,ave}$, g/km; $FC_{CD,ave}$, l/100 km;
	Output step 11	FC_{CD} , l/100 km; FE_{CD} , km/l.		
	Output step 12	If applicable: $EC_{DC,CD,first}$, Wh/km.		For results after 3 phases, $FE_{CD,ave}$, km/l.
14	Output step 13	$EC_{AC,CD,ave}$, Wh/km; $M_{CO2,CD,ave}$, g/km. $FE_{CD,ave}$, km/l.	Declaration of charge-depleting electric energy consumption, fuel efficiency and CO_2 mass emission for each vehicle. Calculation of $EC_{AC,weighted}$ according to paragraph 4.3.2. of this annex. In the case that the interpolation method is applied, the output is available for each vehicle H, L and, if applicable, M.	For results after 4 phases, $EC_{AC,CD,declared}$, Wh/km; $EC_{AC,weighted}$, Wh/km; $M_{CO2,CD,declared}$, g/km. For results after 3 phases, $FE_{CD,declared}$, km/l.

15	Output step 13	EC _{AC,CD,ave} , Wh/km; If applicable: EC _{DC,CD,first,ave} , Wh/km;	If applicable: Adjustment of electric energy consumption for the purpose of COP as described in Appendix 8, paragraph 2.1. to this annex.	EC _{DC,CD,COP} , Wh/km;
	Output step 14	EC _{AC,CD,declared} , Wh/km;	In the case that the interpolation method is applied, the output is available for each vehicle H, L and, if applicable, M.	
16	Output step 15	If applicable: EC _{DC,CD,COP} , Wh/km;	In the case that the interpolation method is applied, intermediate rounding shall be performed according to paragraph 6.1.8. of this Regulation: M _{CO2,CD} shall be rounded to the second place of decimal.	If applicable: EC _{DC,CD,COP,final} , Wh/km;
	Output step 14	EC _{AC,CD,declared} , Wh/km; EC _{AC,weighted} , Wh/km; FE _{CD,declared} , km/l.	M _{CO2,CD} shall be rounded to the second place of decimal. EC _{AC,CD,final} and EC _{AC,weighted,final} shall be rounded to the first place of decimal.	For results after 4 phases, EC _{AC,CD,final} , Wh/km; M _{CO2,CD,final} , g/km; EC _{AC,weighted,final} , Wh/km; FC _{CD,final} , l/100 km;
	Output step 13	M _{CO2,CD,declared} , g/km; FC _{CD,ave} , l/100 km;	EC _{AC,CD,final} and EC _{AC,weighted,final} shall be rounded to the first place of decimal. If applicable: EC _{DC,CD,COP} shall be rounded to the first place of decimal. FC _{CD} and FE _{CD} shall be rounded to the third place of decimal. Output is available for vehicles H and for vehicle L and, if applicable, for vehicle M. In case that the interpolation method is not applied, final rounding shall be applied according to paragraph 6.1.8. of this Regulation: EC _{AC,CD} , EC _{AC,weighted} and M _{CO2,CD} shall be rounded to the nearest whole number. If applicable: EC _{DC,CD,COP} shall be rounded to the nearest whole number. FC _{CD} and FE _{CD} shall be rounded to the first place of decimal.	For results after 3 phases, FE _{CD,final} , km/l;
17	Output step 16	If applicable: EC _{DC,CD,COP,final} , Wh/km; EC _{AC,CD,final} , Wh/km; M _{CO2,CD,final} , g/km; EC _{AC,weighted,final} , Wh/km; FC _{CD,final} , l/100 km; FE _{CD,final} , km/l;	Interpolation of individual values based on input from vehicles H and L and, if applicable, vehicle M. Final rounding of individual vehicle values shall be performed according to paragraph 6.1.8. of this Regulation.	If applicable: EC _{DC,CD,COP,ind} , Wh/km; For results after 4 phases, EC _{AC,CD,ind} , Wh/km; M _{CO2,CD,ind} , g/km; EC _{AC,weighted,ind} , Wh/km; FC _{CD,ind} , l/100 km;
	Result of an individual vehicle. Final test result.			

			<p>$EC_{AC,CD}$, $EC_{AC,weighted}$ and $M_{CO_2,CD}$ shall be rounded to the nearest whole number.</p> <p>If applicable: $EC_{DC,CD,COP}$ shall be rounded to the nearest whole number.</p> <p>FC_{CD} shall be rounded to the first place of decimal.</p> <p>Output is available for each individual vehicle.</p>	<p>For results after 3 phases, $FE_{CD,ind}$, km/l;</p>
--	--	--	--	---

4.6.2. Stepwise procedure for calculating the final charge-sustaining and charge-depleting weighted test results of the Type 1 test for OVC-HEVs

The results shall be calculated in the order described in Table A8/9. All applicable results in the column "Output" shall be recorded. The column "Process" describes the paragraphs to be used for calculation or contains additional calculations.

For the purpose of this table, the following nomenclature within the equations and results is used:

- c considered period is the complete applicable test cycle;
- p every applicable cycle phase; for the purpose of $EAER_{city}$ calculation (as applicable), p shall represent the city driving cycle;
- i applicable criteria emission component (except for CO_2);
- j index for the considered period;
- CS charge-sustaining;
- CD charge-depleting;
- CO_2 CO_2 mass emission;
- REESS Rechargeable Electric Energy Storage System.

Table A8/9

Calculation of final charge-depleting and charge-sustaining weighted values (FE applicable for results after 3 phases only)

Step no.	Source	Input	Process	Output
1	<p>Output step 1, Table A8/8</p> <p>Output step 7, Table A8/8</p> <p>Output step 3, Table A8/8</p>	<p>$M_{i,CD,j}$, g/km; $PN_{CD,j}$, particles per kilometer; $PM_{CD,c}$, mg/km; $M_{CO_2,CD,j}$, g/km; $\Delta E_{REESS,j}$, Wh; d_j, km; AER, km; E_{AC}, Wh;</p> <p>$AER_{city,ave}$, km;</p> <p>n_{veh}; R_{CDC}, km;</p>	<p>Input from CD and CS post processing.</p>	<p>$M_{CO_2,CD,j}$, g/km; AER, km; E_{AC}, Wh; $M_{CO_2,CS,declared}$, g/km; $M_{CO_2,CD,declared}$, g/km; $M_{CO_2,CD,ave}$, g/km;</p> <p>For results after 4 phases $M_{i,CD,j}$, g/km; $PN_{CD,j}$, particles per kilometer; $PM_{CD,c}$, mg/km; $\Delta E_{REESS,j}$, Wh; d_j, km; $AER_{city,ave}$, km;</p>

Step no.	Source	Input	Process	Output
	Output step 4, Table A8/8 Output step 8, Table A8/8 Output step 6, Table A8/5 Output step 7, Table A8/5	$n_{veh,L}$; $n_{veh,H}$; $UF_{phase,j}$; $UF_{cycle,c}$; $M_{i,CS,c,6}$, g/km; $M_{CO_2,CS,declared}$, g/km; $M_{CO_2,CS,p}$		n_{veh} ; R_{CDC} , km; $n_{veh,L}$; $n_{veh,H}$; $UF_{phase,j}$; $UF_{cycle,c}$; $M_{i,CS,c,6}$, g/km; $M_{CO_2,CS,p}$
	Output step 14, Table A8/8 Output step 13, Table A8/8	$M_{CO_2,CD,declared}$, g/km; $M_{CO_2,CD,ave}$, g/km; K_{CO_2} , (g/km)/(Wh/km).	Output in the case of CD is available for each CD test. Output in the case of CS is available once due to CS test averaged values. In the case that the interpolation method is applied, the output (except of K_{CO_2}) is available for vehicle H, L and, if applicable, M. CO ₂ mass emission correction coefficient K_{CO_2} might be necessary according to Appendix 2 to this annex.	K_{CO_2} , (g/km)/(Wh/km).
For results after 4 phases 2	Output step 1	$M_{i,CD,j}$, g/km; $PN_{CD,j}$, particles per kilometer; $PM_{CD,c}$, mg/km; n_{veh} ; $n_{veh,L}$; $UF_{phase,j}$; $UF_{cycle,c}$; $M_{i,CS,c,6}$, g/km;	Calculation of weighted emission (except $M_{CO_2,weighted}$) compounds according to paragraphs 4.1.3.1. to 4.1.3.3. inclusive of this annex. Remark: $M_{i,CS,c,6}$ includes $PN_{CS,c}$ and $PM_{CS,c}$. Output is available for each CD test. In the case that the interpolation method is applied, the output is available for each vehicle L, H and, if applicable, M.	$M_{i,weighted}$, g/km; $PN_{weighted}$, particles per kilometer; $PM_{weighted}$, mg/km;
3	Output step 1	$M_{CO_2,CD,j}$, g/km; $\Delta E_{REESS,j}$, Wh; d_j , km; n_{veh} ; R_{CDC} , km $M_{CO_2,CS,declared}$, g/km; $M_{CO_2,CS,p}$	Calculation of equivalent all-electric range according to paragraphs 4.4.4.1. and 4.4.4.2. of this annex, and actual charge-depleting range according to paragraph 4.4.5. of this annex. Output is available for each CD test. R_{CDA} shall be rounded according to paragraph 6.1.8. of this Regulation to the nearest whole number. In the case that the interpolation method is applied, the output is available for each vehicle L, H and, if applicable, M.	EAER, km; EAER _p , km; R_{CDA} , km.

<i>Step no.</i>	<i>Source</i>	<i>Input</i>	<i>Process</i>	<i>Output</i>
4	Output step 1 Output step 3	AER, km; R _{CDA} , km.	Output is available for each CD test. In the case that the interpolation method is applied, check the availability of AER interpolation between vehicle H, L and, if applicable, M according to paragraph 4.5.7.1. of this annex. If the interpolation method is used, each test shall fulfil the requirement.	AER-interpolation availability.
5	Output step 1	AER, km.	Averaging AER and AER _{dec} declaration. The declared AER shall be rounded according to paragraph 6.1.8. of this Regulation to the number of decimal places specified in Table A6/1 of Annex B6. In the case that the interpolation method is applied and the AER interpolation availability criterion is fulfilled, AER shall be rounded according to paragraph 6.1.8. of this Regulation to the first place of decimal. The output is available for each vehicles H and L and, if applicable, for vehicle M. If the case that the interpolation method is applied but the criterion is not fulfilled, AER of vehicle H shall be applied for the whole interpolation family and shall be rounded according to paragraph 6.1.8. of this Regulation to the nearest whole number. In the case that the interpolation method is not applied, AER shall be rounded according to paragraph 6.1.8. of this Regulation to the nearest whole number.	AER _{ave} , km; For results after 4 phases AER _{dec} , km.
	Interpolation family result. If the interpolation method is not applied, step No. 9 is not required and the output of this step is the final result.			

Step no.	Source	Input	Process	Output
For results after 4 phases, 6	Output step 1	$M_{i,CD,j}$, g/km; $M_{CO_2,CD,j}$, g/km; n_{veh} ; $n_{veh,L}$; $UF_{phase,j}$; $M_{i,CS,c,6}$, g/km; $M_{CO_2,CS,declared}$, g/km. $M_{CO_2,CD,declared}$, g/km; $M_{CO_2,CD,ave}$, g/km;	<p>Calculation of weighted CO₂ mass emission and fuel consumption according to paragraphs 4.1.3.1. and 4.2.3. of this annex.</p> <p>Output is available for each CD test.</p> <p>In the case that the interpolation method is applied, $n_{veh,L}$ cycles shall be used. With reference to paragraph 4.1.2. of this annex, $M_{CO_2,CD,j}$ of the confirmation cycle shall be corrected according to Appendix 2 to this annex.</p> <p>In the case that the interpolation method is applied, the output is available for each vehicle H, vehicle L and, if applicable, vehicle M.</p>	$M_{CO_2,weighted}$, g/km; $FC_{weighted}$, l/100 km;
7	Output step 1	E_{AC} , Wh;	<p>Calculation of the electric energy consumption based in EAER according to paragraphs 4.3.3.1. and 4.3.3.2. of this annex.</p> <p>Output is available for each CD test.</p> <p>In the case that the interpolation method is applied, the output is available for each vehicle H, vehicle L and, if applicable, vehicle M.</p>	EC , Wh/km; EC_p , Wh/km;
	Output step 3	$EAER$, km; $EAER_p$, km;		
8	Output step 1	$AER_{city, ave}$, km;	<p>For results after 3 phases Averaging EC and EC declaration.</p> $EC_{p,final} = EC_{p,ave} \times \frac{EC_{dec}}{EC_{ave}}$ <p>For results after 3 phases and 4 phases Averaging and intermediate rounding according to paragraph 6.1.8. of this Regulation.</p>	<p>For results after 3 phases EC_{dec}, Wh/km; $EC_{p,final}$, Wh/km; $EAER_{final}$, km;</p> <p>For results after 4 phases $AER_{city,final}$, km; $M_{CO_2,weighted,final}$, g/km; $FC_{weighted,final}$, l/100 km;</p>
Interpolation family result. If the interpolation method is not applied, step No. 9 is not required and the output of	Output step 6	$M_{CO_2,weighted}$, g/km; $FC_{weighted}$, l/100 km;		
	Output step 7	EC , Wh/km; EC_p , Wh/km;		
	Output step 3	$EAER$, km; $EAER_p$, km;		

Step no.	Source	Input	Process	Output
this step is the final result.	Output step 5	AER _{dec} , km; AER _{ave} , km..	<p>In the case that the interpolation method is applied, intermediate rounding shall be performed according to paragraph 6.1.8. of this Regulation.</p> $AER_{city,final} = AER_{city,ave} \times \frac{AER_{dec}}{AER_{ave}}$ <p>AER_{city,ave}, EAER and EAER_p shall be rounded to the first place of decimal.</p> <p>M_{CO2,weighted} shall be rounded to the second place of decimal.</p> <p>FC_{weighted} shall be rounded to the third place of decimal.</p> <p>EC and EC_p shall be rounded to the first place of decimal.</p> <p>The output is available for each vehicle H, vehicle L and, if applicable, vehicle M.</p> <p>In case that the interpolation method is not applied, final rounding of the test results shall be applied according to paragraph 6.1.8. of this Regulation.</p> <p>AER_{city,ave}, EAER and EAER_p shall be rounded to the nearest whole number.</p> <p>M_{CO2,weighted} shall be rounded to the nearest whole number.</p> <p>FC_{weighted} shall be rounded to the first place of decimal.</p> <p>EC and EC_p shall be rounded to the nearest whole number.</p>	EC _{final} , Wh/km; EC _{p,final} , Wh/km; EAER _{final} , km; EAER _{p,final} , km.
9 Result of an individual vehicle. Final test result.	Output step 5 Output step 8	AER _{dec} , km; AER _{city,final} , km; M _{CO2,weighted,final} , g/km; FC _{weighted,final} , l/100 km; EC _{final} , Wh/km; EC _{p,final} , Wh/km; EAER _{final} , km; EAER _{p,final} , km;	<p>Interpolation of individual values based on input from vehicle low, medium and high according to paragraph 4.5. of this annex, and final rounding according to paragraph 6.1.8. of this Regulation.</p> <p>AER_{ind}, AER_{city,ind}, EAER_{ind} and EAER_{p,ind} shall be rounded to the nearest whole number.</p>	EC _{ind} , Wh/km; EC _{p,ind} , Wh/km; EAER _{ind} , km; For results after 4 phases, AER _{ind} , km; AER _{city,ind} , km; M _{CO2,weighted,ind} , g/km; FC _{weighted,ind} , l/100 km; EAER _{p,ind} , km.

<i>Step no.</i>	<i>Source</i>	<i>Input</i>	<i>Process</i>	<i>Output</i>
	Output step 4	AER-interpolation availability	$M_{CO_2,weighted,ind}$ shall be rounded to the nearest whole number.	
	Output step 1	R_{CDC}	$EC_{weighted,ind}$ shall be rounded to the first place of decimal. $FC_{weighted,ind}$ shall be rounded to the first place of decimal. EC_{ind} and $EC_{p,ind}$ shall be rounded to the nearest whole number. Output available for each individual vehicles. R_{CDC} shall be rounded according to paragraph 6.1.8. of this Regulation to the nearest whole number.	$R_{CDC,final}$

4.7. Stepwise procedure for calculating the final test results of PEVs

The results shall be calculated in the order described in Table A8/10 of the consecutive cycle procedure and in the order described in Table A8/11 in the case of the shortened test procedure. All applicable results in the column "Output" shall be recorded. The column "Process" describes the paragraphs to be used for calculation or contains additional calculations.

4.7.1. Stepwise procedure for calculating the final test results of PEVs in case of the consecutive cycles procedure

For the purpose of this table, the following nomenclature within the questions and results is used:

j index for the considered period.

Table A8/10

Calculation of final PEV values determined by application of the consecutive cycle Type 1 procedure

For results after 4 phases;

The considered periods shall be the low phase, medium phase, high phase, extra high phase, the applicable WLTP city test cycle and the applicable WLTP test cycle.

For results after 3 phases;

The considered periods shall be the low phase, medium phase, high phase and the applicable WLTP test cycle.

<i>Step no.</i>	<i>Source</i>	<i>Input</i>	<i>Process</i>	<i>Output</i>
1	Annex B8	Test results	<p>Results measured according to Appendix 3 to this annex and pre-calculated according to paragraph 4.3. of this annex.</p> <p>Usable battery energy according to paragraph 4.4.2.2.1. of this annex.</p> <p>Recharged electric energy according to paragraph 3.4.4.3. of this annex.</p> <p>Output available for each test.</p> <p>E_{AC} shall be rounded according to paragraph 6.1.8. of this Regulation to the first place of decimal. In the case that the interpolation method is applied, the output is available for vehicle H and vehicle L.</p>	$\Delta E_{REESS,j}$, Wh; d_j , km; UBE_{CCP} , Wh; E_{AC} , Wh.
2	Output step 1	$\Delta E_{REESS,j}$, Wh; UBE_{CCP} , Wh.	<p>Determination of the number of completely driven applicable WLTC phases and cycles according to paragraph 4.4.2.2. of this annex.</p> <p>Output available for each test.</p> <p>In the case that the interpolation method is applied, the output is available for vehicle H and vehicle L.</p>	n_{WLTC} ; n_{city} ; n_{low} ; n_{med} ; n_{high} ; n_{exHigh} .
3	Output step 1	$\Delta E_{REESS,j}$, Wh; UBE_{CCP} , Wh.	Calculation of weighting factors according to paragraph 4.4.2.2. of this annex.	$K_{WLTC,1}$ $K_{WLTC,2}$ $K_{WLTC,3}$

Step no.	Source	Input	Process	Output
	Output step 2	n_{WLTC} ; n_{city} ; n_{low} ; n_{med} ; n_{high} ; n_{exHigh} .	Note: The number of weighting factors depends on the applicable cycle that was used (3- or 4-phase WLTC). In the case of 4-phase WLTCs, the output in brackets might be needed in addition. Output available for each test. In the case that the interpolation method is applied, the output is available for vehicle H and vehicle L.	$(K_{WLTC,4})$ $K_{city,1}$ $K_{city,2}$ $K_{city,3}$ $(K_{city,4})$ $K_{low,1}$ $K_{low,2}$ $K_{low,3}$ $(K_{low,4})$ $K_{med,1}$ $K_{med,2}$ $K_{med,3}$ $(K_{med,4})$ $K_{high,1}$ $K_{high,2}$ $K_{high,3}$ $(K_{high,4})$ $K_{exHigh,1}$ $K_{exHigh,2}$ $K_{exHigh,3}$ $(K_{exHigh,4})$
4	Output step 1	$\Delta E_{REESS,j}$, Wh; d_j , km; UBE_{CCP} , Wh.	Calculation of electric energy consumption at the REESSs according to paragraph 4.4.2.2. of this annex. Calculation of the electric energy consumption from the first applicable WLTP test cycle $EC_{DC,first}$ as described in Appendix 8, paragraph 1.1. to this annex. Output available for each test. In the case that the interpolation method is applied, the output is available for vehicle H and vehicle L.	$EC_{DC,WLTC}$, Wh/km; $EC_{DC,city}$, Wh/km; $EC_{DC,low}$, Wh/km; $EC_{DC,med}$, Wh/km; $EC_{DC,high}$, Wh/km; $EC_{DC,exHigh}$, Wh/km; $EC_{DC,first}$, Wh/km.
	Output step 2	n_{WLTC} ; n_{city} ; n_{low} ; n_{med} ; n_{high} ; n_{exHigh} .		
	Output step 3	All weighting factors		
5	Output step 1	UBE_{CCP} , Wh;	Calculation of pure electric range according to paragraph 4.4.2.2. of this annex. Output available for each test. In the case that the interpolation method is applied, the output is available for vehicle H and vehicle L.	PER_{WLTC} , km; PER_{city} , km; PER_{low} , km; PER_{med} , km; PER_{high} , km; PER_{exHigh} , km.
	Output step 4	$EC_{DC,WLTC}$, Wh/km; $EC_{DC,city}$, Wh/km; $EC_{DC,low}$, Wh/km; $EC_{DC,med}$, Wh/km; $EC_{DC,high}$, Wh/km; $EC_{DC,exHigh}$, Wh/km.		
6	Output step 1	E_{AC} , Wh;	Calculation of electric energy consumption at the mains according to paragraph 4.3.4. of this annex. Output available for each test. In the case that the interpolation method is applied, the output is available for vehicle H and vehicle L.	EC_{WLTC} , Wh/km; EC_{city} , Wh/km; EC_{low} , Wh/km; EC_{med} , Wh/km; EC_{high} , Wh/km; EC_{exHigh} , Wh/km.
	Output step 5	PER_{WLTC} , km; PER_{city} , km; PER_{low} , km; PER_{med} , km; PER_{high} , km; PER_{exHigh} , km.		

Step no.	Source	Input	Process	Output
7 If the interpolation method is not applied, step No. 10 is not required and the output of this step for PER _{WLTC,dec} and EC _{WLTC,dec} is the final result.	Output step 5	PER _{WLTC} , km; PER _{city} , km; PER _{low} , km; PER _{med} , km; PER _{high} , km; PER _{exHigh} , km;	Averaging of tests for all input values. Declaration of PER _{WLTC,dec} and EC _{WLTC,dec} based on PER _{WLTC,ave} and EC _{WLTC,ave} .	PER _{WLTC,dec} , km; PER _{WLTC,ave} , km; PER _{city,ave} , km; PER _{low,ave} , km; PER _{med,ave} , km; PER _{high,ave} , km; PER _{exHigh,ave} , km;
	Output step 6	EC _{WLTC} , Wh/km; EC _{city} , Wh/km; EC _{low} , Wh/km; EC _{med} , Wh/km; EC _{high} , Wh/km; EC _{exHigh} , Wh/km.	Alignment of PER in case of city, low, med, high and exHigh based on the ratio between PER _{WLTC,dec} and PER _{WLTC,ave} : $AF_{PER} = \frac{PER_{WLTC,dec}}{PER_{WLTC,ave}}$	EC _{WLTC,dec} , Wh/km; EC _{WLTC,ave} , Wh/km; EC _{city,ave} , Wh/km; EC _{low,ave} , Wh/km; EC _{med,ave} , Wh/km; EC _{high,ave} , Wh/km; EC _{exHigh,ave} , Wh/km; EC _{DC,first,ave} , Wh/km.
	Output step 4	EC _{DC,first} , Wh/km.	Alignment of EC in case of city, low, med, high and exHigh based on the ratio between EC _{WLTC,dec} and EC _{WLTC,ave} : $AF_{EC} = \frac{EC_{WLTC,dec}}{EC_{WLTC,ave}}$ In the case that the interpolation method is applied, the output is available for vehicles H and vehicle L. PER _{WLTC,dec} as well as EC _{WLTC,dec} shall be rounded according to paragraph 6.1.8. of this Regulation to the number of places of decimal as specified in Table A6/1 of Annex B6. In the case that the interpolation method is not applied, PER _{WLTC,dec} and EC _{WLTC,dec} shall be rounded according to paragraph 6.1.8. of this Regulation to the nearest whole number. .	
8	Output step 7	EC _{WLTC,dec} , Wh/km; EC _{WLTC,ave} , Wh/km; EC _{DC,first,ave} , Wh/km.	Adjustment of the electric energy consumption for the purpose of COP as described in Appendix 8, paragraph 1.1. to this annex. In the case that the interpolation method is applied, the output is available for vehicle H and vehicle L.	EC _{DC,COP} , Wh/km.

<i>Step no.</i>	<i>Source</i>	<i>Input</i>	<i>Process</i>	<i>Output</i>
9 If the interpolation method is not applied, step No. 10 is not required and the output of this step is the final result.	Output step 7	$PER_{city,ave}$, km; $PER_{low,ave}$, km; $PER_{med,ave}$, km; $PER_{high,ave}$, km; $PER_{exHigh,ave}$, km; $EC_{city,ave}$, Wh/km; $EC_{low,ave}$, Wh/km; $EC_{med,ave}$, Wh/km; $EC_{high,ave}$, Wh/km; $EC_{exHigh,ave}$, Wh/km;	<p>Intermediate rounding according to paragraph 6.1.8. of this Regulation.</p> <p>In the case that the interpolation method is applied, intermediate rounding shall be performed according to paragraph 6.1.8. of this Regulation:</p> <p>PER_{city} and PER_p shall be rounded to the first place of decimal.</p>	$PER_{city,final}$, km; $PER_{low,final}$, km; $PER_{med,final}$, km; $PER_{high,final}$, km; $PER_{exHigh,final}$, km; $EC_{city,final}$, Wh/km; $EC_{low,final}$, Wh/km; $EC_{med,final}$, Wh/km; $EC_{high,final}$, Wh/km; $EC_{exHigh,final}$, Wh/km;
	Output step 8	$EC_{DC,COP}$, Wh/km.	<p>EC_{city} and EC_p shall be rounded to the first place of decimal.</p> <p>$EC_{DC,COP}$ shall be rounded to the first place of decimal.</p> <p>The output is available for vehicle H and vehicle L.</p> <p>In case that the interpolation method is not applied, final rounding of the test results according to paragraph 6.1.8. of this Regulation:</p> <p>PER_{city} and PER_p shall be rounded to the nearest whole number.</p> <p>EC_{city} and EC_p shall be rounded to the nearest whole number.</p> <p>$EC_{DC,COP}$ shall be rounded to the nearest whole number.</p>	$EC_{DC,COP,final}$, Wh/km.
10 Result of an individual vehicle. Final test result.	Output step 7 Output step 9	$PER_{WLTC,dec}$, km; $EC_{WLTC,dec}$, Wh/km $PER_{city,final}$, km; $PER_{low,final}$, km; $PER_{med,final}$, km; $PER_{high,final}$, km; $PER_{exHigh,final}$, km; $EC_{city,final}$, Wh/km; $EC_{low,final}$, Wh/km; $EC_{med,final}$, Wh/km; $EC_{high,final}$, Wh/km; $EC_{exHigh,final}$, Wh/km; $EC_{DC,COP,final}$, Wh/km.	<p>Interpolation of individual values based on input from vehicle H and vehicle L according to paragraph 4.5. of this annex, and final rounding according to paragraph 6.1.8. of this Regulation.</p> <p>PER_{ind}, $PER_{city,ind}$, and $PER_{p,ind}$ shall be rounded to the nearest whole number.</p> <p>EC_{ind}, EC_{city} and $EC_{p,ind}$ shall be rounded to the nearest whole number.</p> <p>$EC_{DC,COP,ind}$ shall be rounded to the nearest whole number.</p> <p>The output is available for each individual vehicle.</p>	$PER_{WLTC,ind}$, km; $PER_{city,ind}$, km; $PER_{low,ind}$, km; $PER_{med,ind}$, km; $PER_{high,ind}$, km; $PER_{exHigh,ind}$, km; $EC_{WLTC,ind}$, Wh/km; $EC_{city,ind}$, Wh/km; $EC_{low,ind}$, Wh/km; $EC_{med,ind}$, Wh/km; $EC_{high,ind}$, Wh/km; $EC_{exHigh,ind}$, Wh/km; $EC_{DC,COP,ind}$, Wh/km.

4.7.2. Stepwise procedure for calculating the final test results of PEVs in case of the shortened test procedure

For the purpose of this table, the following nomenclature within the questions and results is used:

j index for the considered period.

Table A8/11

Calculation of final PEV values determined by application the shortened Type 1 test procedure

For results after 4 phases;

The considered periods shall be the low phase, medium phase, high phase, extra high phase, the applicable WLTP city test cycle and the applicable WLTP test cycle.

For results after 3 phases;

The considered periods shall be the low phase, medium phase, high phase and the applicable WLTP test cycle.

<i>Step no.</i>	<i>Source</i>	<i>Input</i>	<i>Process</i>	<i>Output</i>
1	Annex B8	Test results	<p>Results measured according to Appendix 3 to this annex, and pre-calculated according to paragraph 4.3. of this annex.</p> <p>Usable battery energy according to paragraph 4.4.2.1.1. of this annex.</p> <p>Recharged electric energy according to paragraph 3.4.4.3. of this annex.</p> <p>Output is available for each test.</p> <p>E_{AC} shall be rounded according to paragraph 6.1.8. of this Regulation to the first place of decimal.</p> <p>In the case that the interpolation method is applied, the output is available for vehicle H and vehicle L.</p>	<p>$\Delta E_{REESS,j}$, Wh; d_j, km;</p> <p>UBE_{STP}, Wh;</p> <p>E_{AC}, Wh.</p>
2	Output step 1	$\Delta E_{REESS,j}$, Wh; UBE_{STP} , Wh.	<p>Calculation of weighting factors according to paragraph 4.4.2.1. of this annex.</p> <p>Output is available for each test.</p> <p>In the case that the interpolation method is applied, the output is available for vehicle H and vehicle L.</p>	<p>$K_{WLTC,1}$ $K_{WLTC,2}$ $K_{city,1}$ $K_{city,2}$ $K_{city,3}$ $K_{city,4}$ $K_{low,1}$ $K_{low,2}$ $K_{low,3}$ $K_{low,4}$ $K_{med,1}$ $K_{med,2}$ $K_{med,3}$ $K_{med,4}$ $K_{high,1}$ $K_{high,2}$ $K_{exHigh,1}$ $K_{exHigh,2}$</p>

Step no.	Source	Input	Process	Output
3	Output step 1 Output step 2	$\Delta E_{REESS,j}$, Wh; d_j , km; UB_{ESTP} , Wh. All weighting	Calculation of electric energy consumption at the REESSs according to paragraph 4.4.2.1. of this annex. Calculation of the electric energy consumption from the first applicable WLTP test cycle $EC_{DC,first}$ as described in Appendix 8, paragraph 1.1. to this annex. Output is available for each test. In the case that the interpolation method is applied, the output is available for vehicle H and vehicle L.	$EC_{DC,WLTC}$, Wh/km; $EC_{DC,city}$, Wh/km; $EC_{DC,low}$, Wh/km; $EC_{DC,med}$, Wh/km; $EC_{DC,high}$, Wh/km; $EC_{DC,exHigh}$, Wh/km; $EC_{DC,first}$, Wh/km.
4	Output step 1 Output step 3	UB_{ESTP} , Wh; $EC_{DC,WLTC}$, Wh/km; $EC_{DC,city}$, Wh/km; $EC_{DC,low}$, Wh/km; $EC_{DC,med}$, Wh/km; $EC_{DC,high}$, Wh/km; $EC_{DC,exHigh}$, Wh/km.	Calculation of pure electric range according to paragraph 4.4.2.1. of this annex. Output is available for each test. In the case that the interpolation method is applied, the output is available for vehicle H and vehicle L.	PER_{WLTC} , km; PER_{city} , km; PER_{low} , km; PER_{med} , km; PER_{high} , km; PER_{exHigh} , km.
5	Output step 1 Output step 4	E_{AC} , Wh; PER_{WLTC} , km; PER_{city} , km; PER_{low} , km; PER_{med} , km; PER_{high} , km; PER_{exHigh} , km.	Calculation of electric energy consumption at the mains according to paragraph 4.3.4. of this annex. Output is available for each test. In the case that the interpolation method is applied, the output is available for vehicle H and vehicle L.	EC_{WLTC} , Wh/km; EC_{city} , Wh/km; EC_{low} , Wh/km; EC_{med} , Wh/km; EC_{high} , Wh/km; EC_{exHigh} , Wh/km.
6	Output step 4 Output step 5	PER_{WLTC} , km; PER_{city} , km; PER_{low} , km; PER_{med} , km; PER_{high} , km; PER_{exHigh} , km; EC_{WLTC} , Wh/km; EC_{city} , Wh/km; EC_{low} , Wh/km; EC_{med} , Wh/km; EC_{high} , Wh/km; EC_{exHigh} , Wh/km.	Averaging of tests for all input values. Declaration of $PER_{WLTC,dec}$ and $EC_{WLTC,dec}$ based on $PER_{WLTC,ave}$ and $EC_{WLTC,ave}$. Alignment of PER in case of city, low, med, high and exHigh based on the ratio between $PER_{WLTC,dec}$ and $PER_{WLTC,ave}$:	$PER_{WLTC,dec}$, km; $PER_{WLTC,ave}$, km; $PER_{city,ave}$, km; $PER_{low,ave}$, km; $PER_{med,ave}$, km; $PER_{high,ave}$, km; $PER_{exHigh,ave}$, km; $EC_{WLTC,dec}$, Wh/km; $EC_{WLTC,ave}$, Wh/km; $EC_{city,ave}$, Wh/km; $EC_{low,ave}$, Wh/km;

Step no.	Source	Input	Process	Output
the final result.	Output step 3	EC _{DC,first} , Wh/km.	$AF_{PER} = \frac{PER_{WLTC,dec}}{PER_{WLTC,ave}}$ <p>Alignment of EC in case of city, low, med, high and exHigh based on the ratio between EC_{WLTC,dec} and EC_{WLTC,ave}:</p> $AF_{EC} = \frac{EC_{WLTC,dec}}{EC_{WLTC,ave}}$ <p>In the case that the interpolation method is applied, the output is available for vehicle H and vehicle L. PER_{WLTC,dec} as well as EC_{WLTC,dec} shall be rounded according to paragraph 6.1.8. of this Regulation to the number of places of decimal specified in Table A6/1 of Annex B6.</p> <p>In the case that the interpolation method is not applied, PER_{WLTC,dec} and EC_{WLTC,dec} shall be rounded according to paragraph 6.1.8. of this Regulation to the nearest whole number.</p>	EC _{med,ave} , Wh/km; EC _{high,ave} , Wh/km; EC _{exHigh,ave} , Wh/km; EC _{DC,first,ave} , Wh/km.
7	Output step 6	EC _{WLTC,dec} , Wh/km; EC _{WLTC,ave} , Wh/km; EC _{DC,first,ave} , Wh/km.	<p>Adjustment of the electric energy consumption for the purpose of COP as described in Appendix 8, Paragraph 1.1. to this annex.</p> <p>In the case that the interpolation method is applied, the output is available for vehicle H and vehicle L.</p>	EC _{DC,COP} , Wh/km.
8 Interpolation family result. If the interpolation method is not applied, step No. 9 is not required and the output of this step is the final result.	Output step 6	PER _{city,ave} , km; PER _{low,ave} , km; PER _{med,ave} , km; PER _{high,ave} , km; PER _{exHigh,ave} , km; EC _{city,ave} , Wh/km; EC _{low,ave} , Wh/km; EC _{med,ave} , Wh/km; EC _{high,ave} , Wh/km; EC _{exHigh,ave} , Wh/km;	<p>Intermediate rounding according to paragraph 6.1.8. of this Regulation.</p> <p>In the case that the interpolation method is applied, intermediate rounding shall be performed according to paragraph 6.1.8. of this Regulation:</p> <p>PER_{city} and PER_p shall be rounded to the first place of decimal.</p> <p>EC_{city} and EC_p shall be rounded to the first place of decimal.</p>	PER _{city,final} , km; PER _{low,final} , km; PER _{med,final} , km; PER _{high,final} , km; PER _{exHigh,final} , km; EC _{city,final} , Wh/km; EC _{low,final} , Wh/km; EC _{med,final} , Wh/km; EC _{high,final} , Wh/km; EC _{exHigh,final} , Wh/km; EC _{DC,COP,final} , Wh/km.

<i>Step no.</i>	<i>Source</i>	<i>Input</i>	<i>Process</i>	<i>Output</i>
	Output step 7	EC _{DC,COP} , Wh/km.	<p>EC_{DC,COP} shall be rounded to the first place of decimal.</p> <p>The output is available for vehicle H and vehicle L.</p> <p>In case that the interpolation method is not applied, final rounding of the test results according to paragraph 6.1.8. of this Regulation shall apply:</p> <p>PER_{city} and PER_p shall be rounded to the nearest whole number.</p> <p>EC_{city} and EC_p shall be rounded to the nearest whole number.</p> <p>EC_{DC,COP} shall be rounded to the nearest whole number.</p>	
9	Output step 6	PER _{WLTC,dec} , km; EC _{WLTC,dec} , Wh/km;	<p>Interpolation of individual values based on input from vehicle H and vehicle L according to paragraph 4.5. of this annex, and final rounding according to paragraph 6.1.8. of this Regulation.</p> <p>PER_{ind}, PER_{city,ind}, and PER_{p,ind} shall be rounded to the nearest whole number.</p> <p>EC_{ind}, EC_{city} and EC_{p,ind} shall be rounded to the nearest whole number.</p> <p>EC_{DC,COP,ind} shall be rounded to the nearest whole number.</p> <p>Output available for each individual vehicle.</p>	<p>PER_{WLTC,ind}, km; PER_{city,ind}, km; PER_{low,ind}, km; PER_{med,ind}, km; PER_{high,ind}, km; PER_{exHigh,ind}, km;</p> <p>EC_{WLTC,ind}, Wh/km; EC_{city,ind}, Wh/km; EC_{low,ind}, Wh/km; EC_{med,ind}, Wh/km; EC_{high,ind}, Wh/km; EC_{exHigh,ind}, Wh/km;</p> <p>EC_{DC,COP,ind}, Wh/km.</p>
	Output step 8	<p>PER_{city,final}, km; PER_{low,final}, km; PER_{med,final}, km; PER_{high,final}, km; PER_{exHigh,final}, km;</p> <p>EC_{city,final}, Wh/km; EC_{low,final}, Wh/km; EC_{med,final}, Wh/km; EC_{high,final}, Wh/km; EC_{exHigh,final}, Wh/km;</p> <p>EC_{DC,COP,final}, Wh/km.</p>		

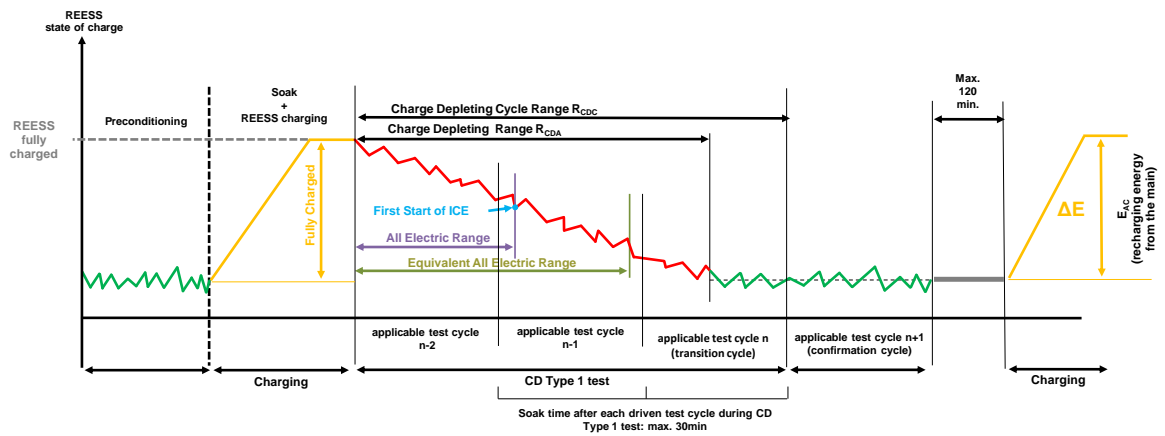
Annex B8 - Appendix 1

REESS state of charge profile

1. Test sequences and REESS profiles: OVC-HEVs, charge-depleting and charge-sustaining test
 - 1.1. Test sequence OVC-HEVs according to Option 1

Charge-depleting type 1 test with no subsequent charge-sustaining Type 1 test (Figure A8.App1/1)

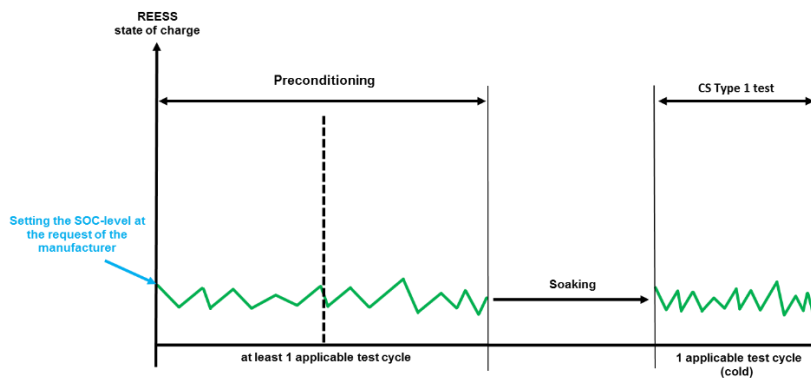
Figure A8.App1/1
OVC-HEVs, charge-depleting Type 1 test



- 1.2. Test sequence OVC-HEVs according to Option 2

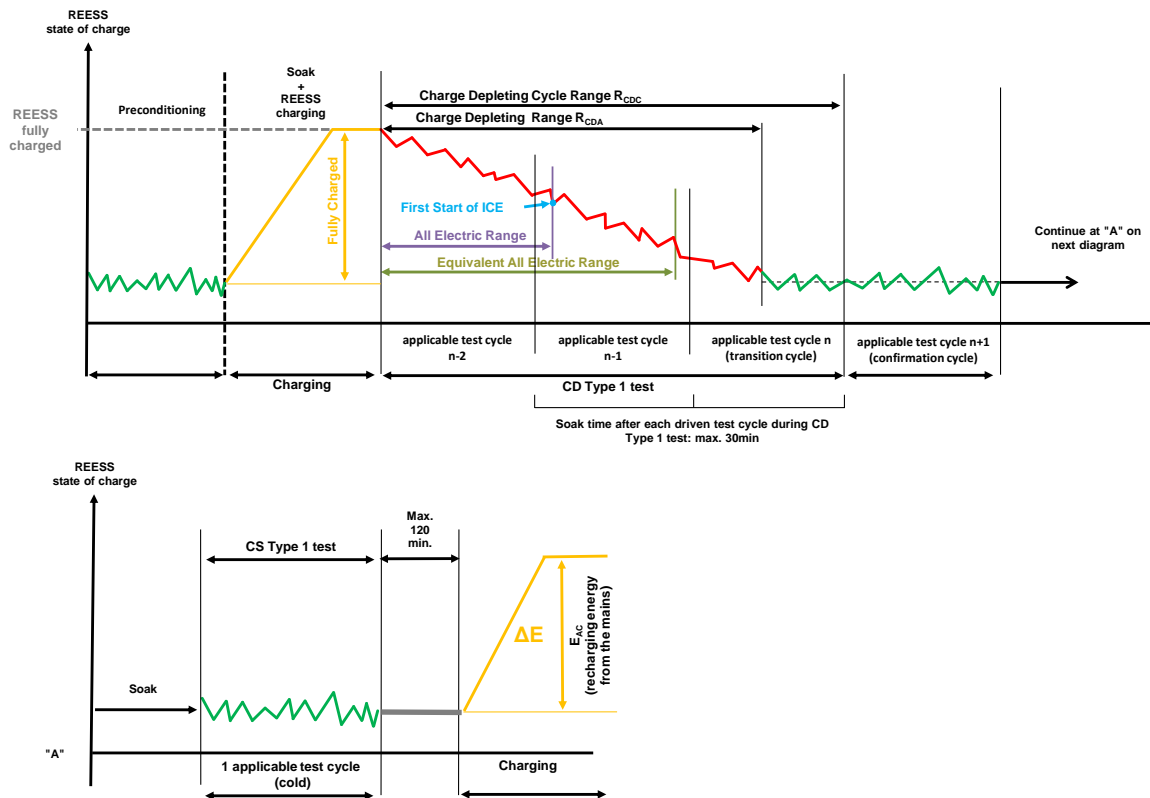
Charge-sustaining Type 1 test with no subsequent charge-depleting Type 1 test (Figure A8.App1/2).

Figure A8.App1/2
OVC-HEVs, charge-sustaining Type 1 test



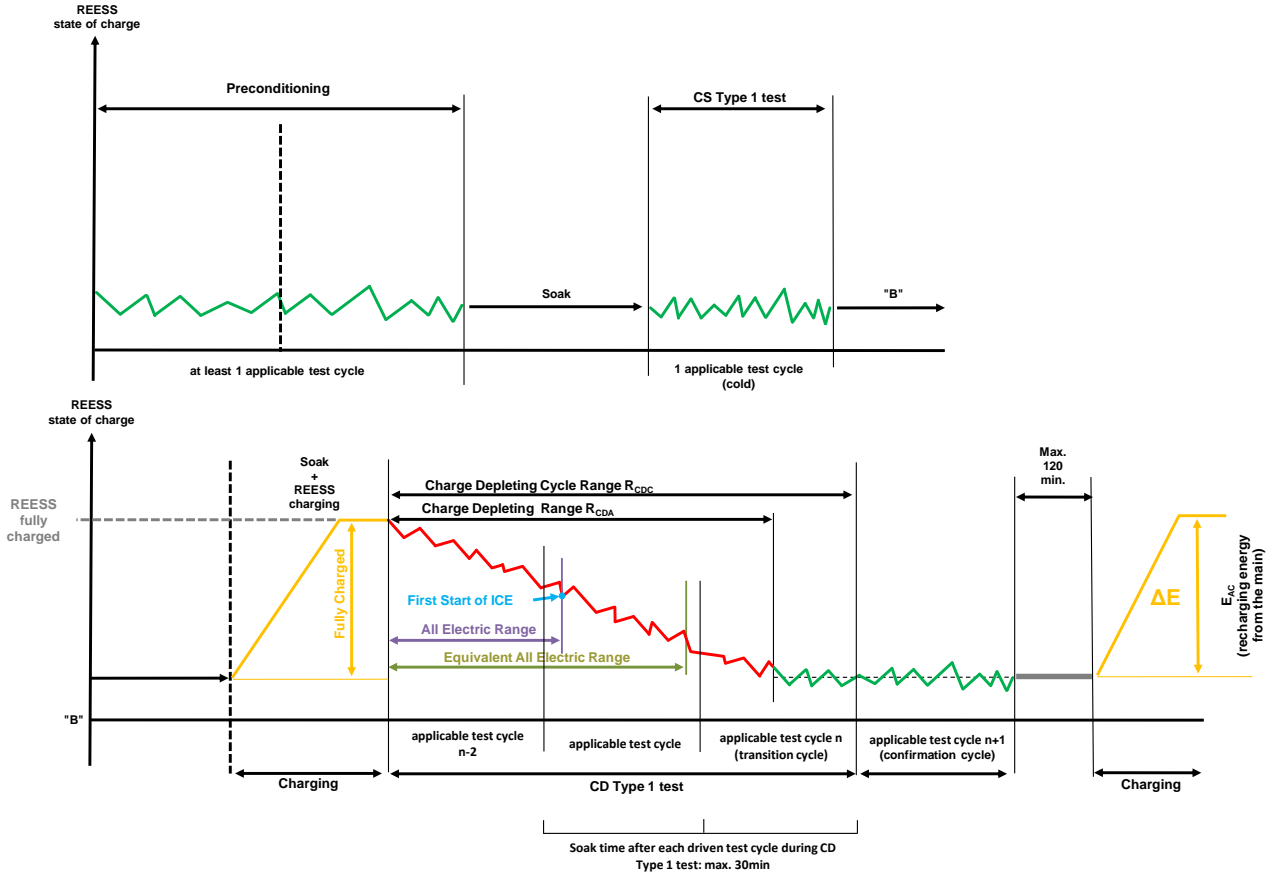
1.3. Test sequence OVC-HEVs according to Option 3
 Charge-depleting Type 1 test with subsequent charge-sustaining Type 1 test
 (Figure A8.App1/3).

Figure A8.App1/3
OVC-HEVs, charge-depleting type 1 test with subsequent charge-sustaining Type 1 test



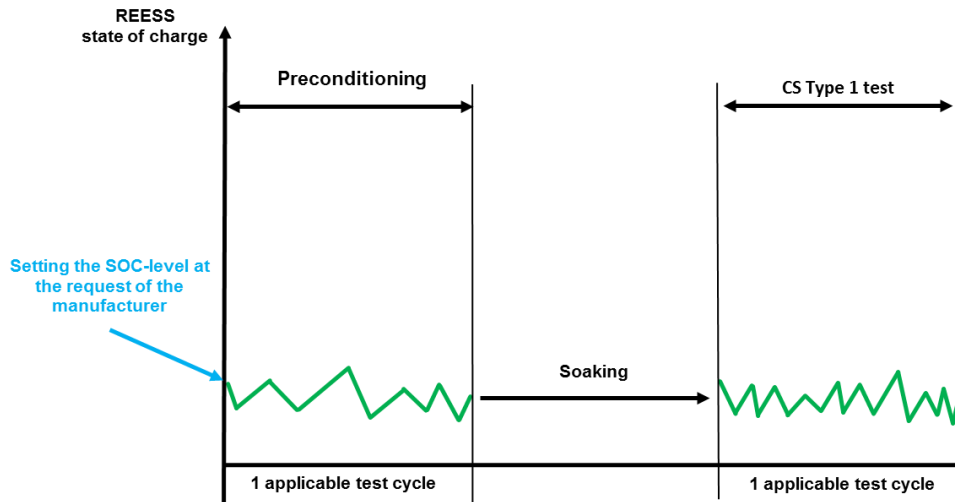
1.4. Test sequence OVC-HEVs according to Option 4
 Charge-sustaining Type 1 test with subsequent charge-depleting Type 1 test
 (Figure A8.App1/4)

Figure A8.App1/4
OVC-HEVs, charge-sustaining Type 1 test with subsequent charge-depleting Type 1 test



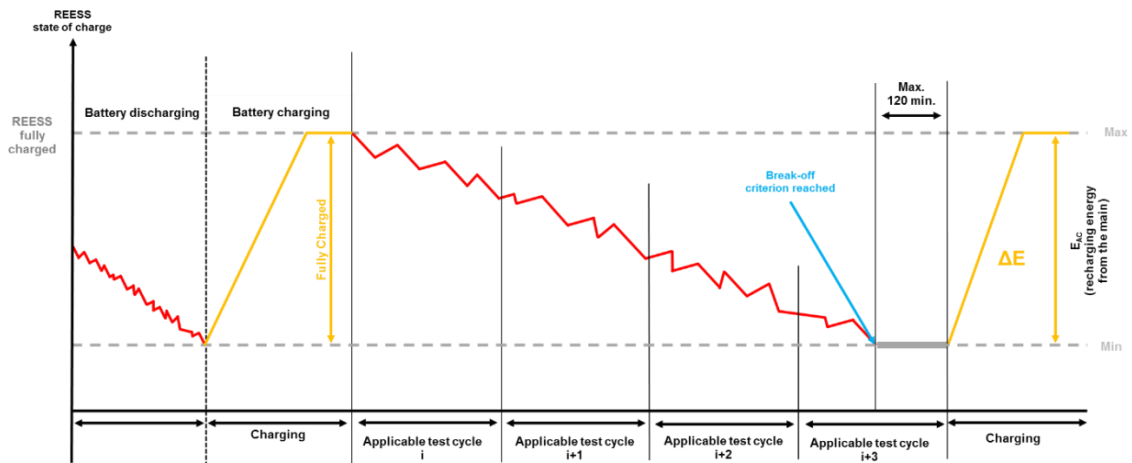
2. Test sequence NOVC-HEVs and NOVC-FCHVs
 Charge-sustaining Type 1 test (Figure A8.App1/5)

Figure A8.App1/5
NOVC-HEVs and NOVC-FCHVs, charge-sustaining Type 1 test



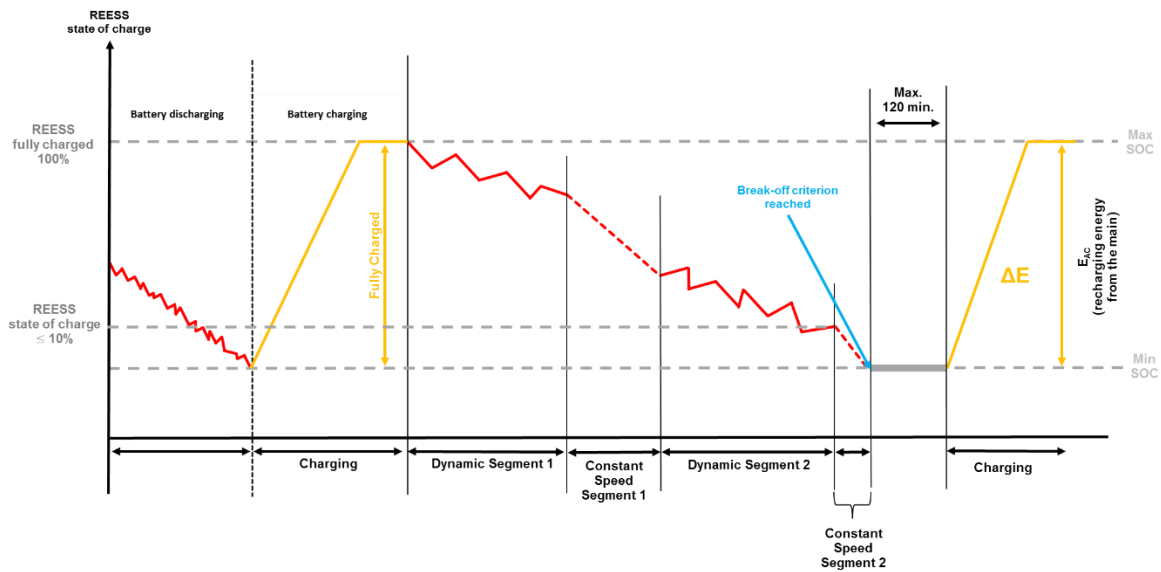
3. Test sequences PEV
 3.1. Consecutive cycles procedure (Figure A8.App1/6)

Figure A8.App1/6
Consecutive cycles test sequence PEV



3.2. Shortened test procedure (Figure A8.App1/7)

Figure A8.App1/7
Shortened test procedure test sequence for PEVs



Annex B8 - Appendix 2

REESS energy change-based correction procedure

This Appendix describes the procedure to correct the charge-sustaining Type 1 test CO₂ mass emission for NOVC-HEVs and OVC-HEVs, and the fuel consumption for NOVC-FCHVs as a function of the electric energy change of all REESSs.

1. General requirements
 - 1.1. Applicability of this appendix
 - 1.1.1. The correction shall be applied on the phase-specific fuel consumptions for NOVC-FCHVs and on the phase-specific CO₂ mass emissions for NOVC-HEVs and OVC-HEVs of the charge-sustaining Type 1 test.
 - 1.1.2. The application of the correction over the total cycle on the fuel consumption for NOVC-FCHVs, on the CO₂ mass emission for NOVC-HEVs and OVC-HEVs is based on the charge-sustaining REESS energy change $\Delta E_{\text{REESS,CS}}$ of the charge-sustaining Type 1 test and the correction criterion c .

For the calculation of $\Delta E_{\text{REESS,CS}}$, paragraph 4.3. of this annex shall be used. The considered period j used in paragraph 4.3. of this annex is defined by the charge-sustaining Type 1 test. The correction criterion c shall be determined according to paragraph 1.2. of this Appendix.

- 1.1.3. The correction over the total cycle shall be applied on the fuel consumption for NOVC-FCHVs, the CO₂ mass emission for NOVC-HEVs and OVC-HEVs if $\Delta E_{\text{REESS,CS}}$ is negative which corresponds to REESS discharging and the correction criterion c calculated in paragraph 1.2. of this appendix is greater than the applicable threshold according to Table A8.App2/1.
- 1.1.4. The correction over the total cycle may be omitted on the fuel consumption for NOVC-FCHVs, the CO₂ mass emission for NOVC-HEVs and OVC-HEVs and uncorrected values may be used if:
 - (a) $\Delta E_{\text{REESS,CS}}$ is positive which corresponds to REESS charging and the correction criterion c calculated in paragraph 1.2. of this appendix is greater than the applicable threshold according to Table A8.App2/1;
 - (b) The correction criterion c calculated in paragraph 1.2. of this appendix is smaller than the applicable threshold according to Table A8.App2/1;
 - (c) The manufacturer can prove to the responsible authority by measurement that there is no relation between $\Delta E_{\text{REESS,CS}}$ and charge-sustaining CO₂ mass emission and $\Delta E_{\text{REESS,CS}}$ and fuel consumption respectively.
- 1.2. The correction criterion c is the ratio between the absolute value of the REESS electric energy change $\Delta E_{\text{REESS,CS}}$ and the fuel energy and shall be calculated as follows:

$$c = \frac{|\Delta E_{\text{REESS,CS}}|}{E_{\text{fuel,CS}}}$$

where:

$\Delta E_{\text{REESS,CS}}$ is the charge-sustaining REESS energy change according to paragraph 1.1.2. of this appendix, Wh;

$E_{\text{fuel,CS}}$ is the charge-sustaining energy content of the consumed fuel according to paragraph 1.2.1. of this appendix in the case of NOVC-HEVs and OVC-HEVs, and according to paragraph 1.2.2. of this appendix in the case of NOVC-FCHVs, Wh.

1.2.1. Charge-sustaining fuel energy for NOVC-HEVs and OVC-HEVs

The charge-sustaining energy content of the consumed fuel for NOVC-HEVs and OVC-HEVs shall be calculated using the following equation:

$$E_{\text{fuel,CS}} = 10 \times \text{HV} \times \text{FC}_{\text{CS,nb}} \times d_{\text{CS}}$$

where:

$E_{\text{fuel,CS}}$ is the charge-sustaining energy content of the consumed fuel of the applicable WLTP test cycle of the charge-sustaining Type 1 test, Wh;

HV is the heating value according to Table A6.App2/1, kWh/l;

$\text{FC}_{\text{CS,nb}}$ is the non-balanced charge-sustaining fuel consumption of the charge-sustaining Type 1 test, not corrected for the energy balance, determined according to paragraph 6. of Annex B7, using the gaseous emission compound values according to Table A8/5, step No. 2, l/100 km;

d_{CS} is the distance driven over the corresponding applicable WLTP test cycle, km;

10 conversion factor to Wh.

1.2.2. Charge-sustaining fuel energy for NOVC-FCHVs

The charge-sustaining energy content of the consumed fuel for NOVC-FCHVs shall be calculated using the following equation:

$$E_{\text{fuel,CS}} = \frac{1}{0.36} \times 121 \times \text{FC}_{\text{CS,nb}} \times d_{\text{CS}}$$

where:

$E_{\text{fuel,CS}}$ is the charge-sustaining energy content of the consumed fuel of the applicable WLTP test cycle of the charge-sustaining Type 1 test, Wh;

121 is the lower heating value of hydrogen, MJ/kg;

$\text{FC}_{\text{CS,nb}}$ is the non-balanced charge-sustaining fuel consumption of the charge-sustaining Type 1 test, not corrected for the energy balance, determined according to Table A8/7, step No. 1, kg/100 km;

d_{CS} is the distance driven over the corresponding applicable WLTP test cycle, km;

$\frac{1}{0.36}$ conversion factor to Wh.

Table A8.App2/1

RCB correction criteria thresholds

<i>Applicable Type 1 test cycle</i>	<i>Low + Medium</i>	<i>Low + Medium + High</i>	<i>Low + Medium + High + Extra High</i>
Thresholds for correction criterion c	0.015	0.01	0.005

2. Calculation of correction coefficients

2.1. The CO₂ mass emission correction coefficient K_{CO_2} , the fuel consumption correction coefficients $K_{\text{fuel,FCHV}}$, as well as, if required by the manufacturer,

the phase-specific correction coefficients $K_{CO_2,p}$ and $K_{fuel,FCHV,p}$ shall be developed based on the applicable charge-sustaining Type 1 test cycles.

In the case that vehicle H was tested for the development of the correction coefficient for CO₂ mass emission for NOVC-HEVs and OVC-HEVs, the coefficient may be applied to vehicles that fulfil the same interpolation family criteria.

- 2.2. The correction coefficients shall be determined from a set of charge-sustaining Type 1 tests according to paragraph 3. of this appendix. The number of tests performed by the manufacturer shall be equal to or greater than five.

The manufacturer may request to set the state of charge of the REESS prior to the test according to the manufacturer's recommendation and as described in paragraph 3. of this appendix. This practice shall only be used for the purpose of achieving a charge-sustaining Type 1 test with opposite sign of the $\Delta E_{REESS,CS}$ and with approval of the responsible authority.

The set of measurements shall fulfil the following criteria:

- (a) The set shall contain at least one test with $\Delta E_{REESS,CS,n} \leq 0$ and at least one test with $\Delta E_{REESS,CS,n} > 0$. $\Delta E_{REESS,CS,n}$ is the sum of electric energy changes of all REESSs of test n calculated according to paragraph 4.3. of this annex.
- (b) The difference in $M_{CO_2,CS}$ between the test with the highest negative electric energy change and the test with the highest positive electric energy change shall be greater than or equal to 5 g/km. This criterion shall not be applied for the determination of $K_{fuel,FCHV}$.

In the case of the determination of K_{CO_2} , the required number of tests may be reduced to three tests if all of the following criteria are fulfilled in addition to (a) and (b):

- (c) The difference in $M_{CO_2,CS}$ between any two adjacent measurements, related to the electric energy change during the test, shall be less than or equal to 10 g/km.
- (d) In addition to (b), the test with the highest negative electric energy change and the test with the highest positive electric energy change shall not be within the region that is defined by:

$$-0.01 \leq \frac{\Delta E_{REESS}}{E_{fuel}} \leq +0.01,$$

where:

E_{fuel} is the energy content of the consumed fuel calculated according to paragraph 1.2. of this appendix, Wh.

- (e) The difference in $M_{CO_2,CS}$ between the test with the highest negative electric energy change and the mid-point, and the difference in $M_{CO_2,CS}$ between the mid-point and the test with the highest positive electric energy change shall be similar and preferably be within the range defined by (d). If this requirement is not feasible, the responsible authority shall decide if a retest is necessary.

The correction coefficients determined by the manufacturer shall be reviewed and approved by the responsible authority prior to its application.

If the set of at least five tests does not fulfil criterion (a) or criterion (b) or both, the manufacturer shall provide evidence to the responsible authority as to why the vehicle is not capable of meeting either or both criteria. If the responsible authority is not satisfied with the evidence, it may require additional tests to be performed. If the criteria after additional tests are still not fulfilled, the

responsible authority shall determine a conservative correction coefficient, based on the measurements.

2.3. Calculation of correction coefficients $K_{\text{fuel,FCHV}}$ and K_{CO_2}

2.3.1. Determination of the fuel consumption correction coefficient $K_{\text{fuel,FCHV}}$

For NOVC-FCHVs, the fuel consumption correction coefficient $K_{\text{fuel,FCHV}}$, determined by driving a set of charge-sustaining Type 1 tests, is defined using the following equation:

$$K_{\text{fuel,FCHV}} = \frac{\sum_{n=1}^{n_{\text{CS}}} \left((EC_{\text{DC,CS},n} - EC_{\text{DC,CS,avg}}) \times (FC_{\text{CS,nb},n} - FC_{\text{CS,nb,avg}}) \right)}{\sum_{n=1}^{n_{\text{CS}}} (EC_{\text{DC,CS},n} - EC_{\text{DC,CS,avg}})^2}$$

where:

$K_{\text{fuel,FCHV}}$ is the fuel consumption correction coefficient, (kg/100 km)/(Wh/km);

$EC_{\text{DC,CS},n}$ is the charge-sustaining electric energy consumption of test n based on the REESS depletion according to the equation below, Wh/km

$EC_{\text{DC,CS,avg}}$ is the mean charge-sustaining electric energy consumption of n_{CS} tests based on the REESS depletion according to the equation below, Wh/km;

$FC_{\text{CS,nb},n}$ is the charge-sustaining fuel consumption of test n, not corrected for the energy balance, according to Table A8/7, step No. 1, kg/100 km;

$FC_{\text{CS,nb,avg}}$ is the arithmetic average of the charge-sustaining fuel consumption of n_{CS} tests based on the fuel consumption, not corrected for the energy balance, according to the equation below, kg/100 km;

n is the index number of the considered test;

n_{CS} is the total number of tests;

and:

$$EC_{\text{DC,CS,avg}} = \frac{1}{n_{\text{CS}}} \times \sum_{n=1}^{n_{\text{CS}}} EC_{\text{DC,CS},n}$$

and:

$$FC_{\text{CS,nb,avg}} = \frac{1}{n_{\text{CS}}} \times \sum_{n=1}^{n_{\text{CS}}} FC_{\text{CS,nb},n}$$

and:

$$EC_{\text{DC,CS},n} = \frac{\Delta E_{\text{REESS,CS},n}}{d_{\text{CS},n}}$$

where:

$\Delta E_{\text{REESS,CS},n}$ is the charge-sustaining REESS electric energy change of test n according to paragraph 1.1.2. of this appendix, Wh;

$d_{\text{CS},n}$ is the distance driven over the corresponding charge-sustaining Type 1 test n, km.

The fuel consumption correction coefficient shall be rounded according to paragraph 6.1.8. of this Regulation to four significant figures. The statistical significance of the fuel consumption correction coefficient shall be evaluated by the responsible authority.

2.3.1.1. It is permitted to apply the fuel consumption correction coefficient that was developed from tests over the whole applicable WLTP test cycle for the correction of each individual phase.

2.3.1.2. Additional to the requirements of paragraph 2.2. of this appendix, at the manufacturer's request and upon approval of the responsible authority, separate fuel consumption correction coefficients $K_{\text{fuel,FCHV,p}}$ for each individual phase may be developed. In this case, the same criteria as described in paragraph 2.2. of this appendix shall be fulfilled in each individual phase and the procedure described in paragraph 2.3.1. of this appendix shall be applied for each individual phase to determine each phase specific correction coefficient.

2.3.2. Determination of CO₂ mass emission correction coefficient K_{CO_2}

For OVC-HEVs and NOVC-HEVs, the CO₂ mass emission correction coefficient K_{CO_2} , determined by driving a set of charge-sustaining Type 1 tests, is defined by the following equation:

$$K_{\text{CO}_2} = \frac{\sum_{n=1}^{n_{\text{CS}}} \left((EC_{\text{DC,CS,n}} - EC_{\text{DC,CS,avg}}) \times (M_{\text{CO}_2,\text{CS,nb,n}} - M_{\text{CO}_2,\text{CS,nb,avg}}) \right)}{\sum_{n=1}^{n_{\text{CS}}} (EC_{\text{DC,CS,n}} - EC_{\text{DC,CS,avg}})^2}$$

where:

K_{CO_2} is the CO₂ mass emission correction coefficient, (g/km)/(Wh/km);

$EC_{\text{DC,CS,n}}$ is the charge-sustaining electric energy consumption of test n based on the REESS depletion according to paragraph 2.3.1. of this appendix, Wh/km;

$EC_{\text{DC,CS,avg}}$ is the arithmetic average of the charge-sustaining electric energy consumption of n_{CS} tests based on the REESS depletion according to paragraph 2.3.1. of this appendix, Wh/km;

$M_{\text{CO}_2,\text{CS,nb,n}}$ is the charge-sustaining CO₂ mass emission of test n, not corrected for the energy balance, calculated according Table A8/5, step No. 2, g/km;

$M_{\text{CO}_2,\text{CS,nb,avg}}$ is the arithmetic average of the charge-sustaining CO₂ mass emission of n_{CS} tests based on the CO₂ mass emission, not corrected for the energy balance, according to the equation below, g/km;

n is the index number of the considered test;

n_{CS} is the total number of tests;

and:

$$M_{\text{CO}_2,\text{CS,nb,avg}} = \frac{1}{n_{\text{CS}}} \times \sum_{n=1}^{n_{\text{CS}}} M_{\text{CO}_2,\text{CS,nb,n}}$$

The CO₂ mass emission correction coefficient shall be rounded according to paragraph 6.1.8. of this Regulation to four significant figures. The statistical significance of the CO₂ mass emission correction coefficient shall be evaluated by the responsible authority.

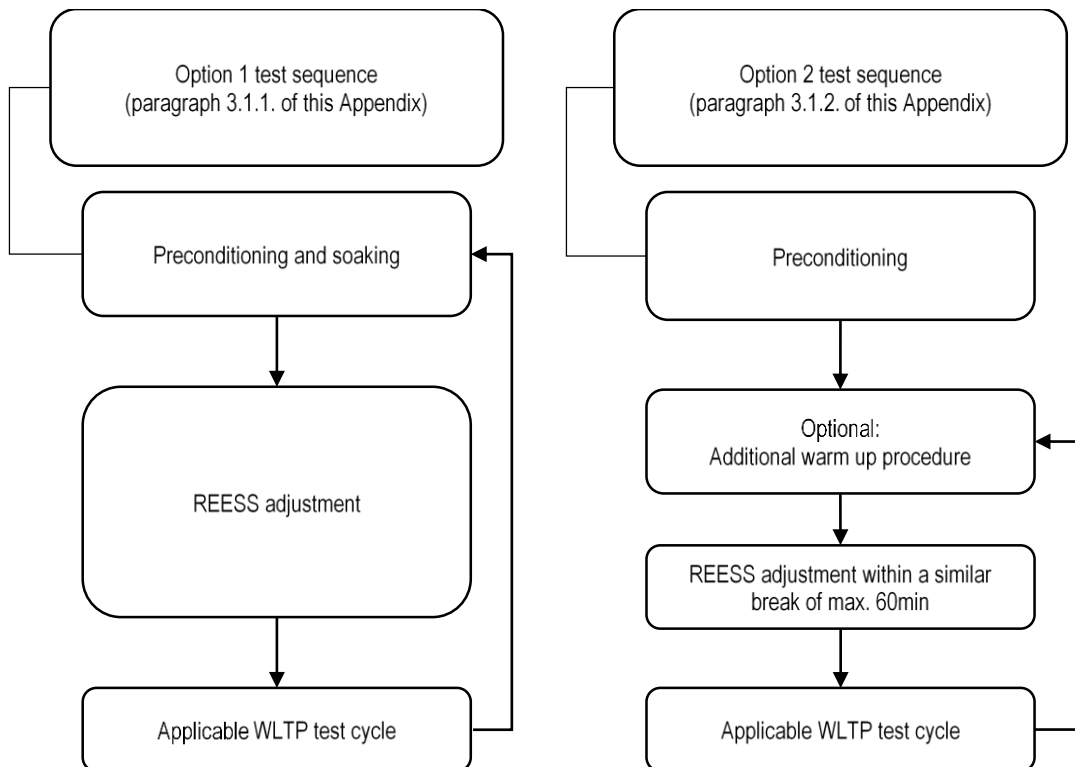
2.3.2.1. It is permitted to apply the CO₂ mass emission correction coefficient developed from tests over the whole applicable WLTP test cycle for the correction of each individual phase.

2.3.2.2. Additional to the requirements of paragraph 2.2. of this appendix, at the request of the manufacturer and upon approval of the responsible authority, separate CO₂ mass emission correction coefficients $K_{\text{CO}_2,p}$ for each individual phase may be developed. In this case, the same criteria as described in paragraph 2.2. of this appendix shall be fulfilled in each individual phase and the procedure described in paragraph 2.3.2. of this appendix shall be applied for each individual phase to determine phase-specific correction coefficients.

- 3. Test procedure for the determination of the correction coefficients
- 3.1. OVC-HEVs

For OVC-HEVs, one of the following test sequences according to Figure A8.App2/1 shall be used to measure all values that are necessary for the determination of the correction coefficients according to paragraph 2. of this appendix.

Figure A8.App2/1
OVC-HEV test sequences



- 3.1.1. Option 1 test sequence
 - 3.1.1.1. Preconditioning and soaking

Preconditioning and soaking shall be conducted according to paragraph 2.1. of Appendix 4 to this annex.
 - 3.1.1.2. REESS adjustment

Prior to the test procedure according to paragraph 3.1.1.3. of this appendix, the manufacturer may adjust the REESS. The manufacturer shall provide evidence that the requirements for the beginning of the test according to paragraph 3.1.1.3. of this appendix are fulfilled.
 - 3.1.1.3. Test procedure
 - 3.1.1.3.1. The driver-selectable mode for the applicable WLTP test cycle shall be selected according to paragraph 3. of Appendix 6 to this annex.
 - 3.1.1.3.2. For testing, the applicable WLTP test cycle according to paragraph 1.4.2. of this annex shall be driven.
 - 3.1.1.3.3. Unless stated otherwise in this appendix, the vehicle shall be tested according to the Type 1 test procedure described in Annex B6.
 - 3.1.1.3.4. To obtain a set of applicable WLTP test cycles required for the determination of the correction coefficients, the test may be followed by a number of consecutive sequences required according to paragraph 2.2. of this appendix

consisting of paragraph 3.1.1.1. to paragraph 3.1.1.3. inclusive of this appendix.

3.1.2. Option 2 test sequence

3.1.2.1. Preconditioning

The test vehicle shall be preconditioned according to paragraph 2.1.1. or paragraph 2.1.2. of Appendix 4 to this annex.

3.1.2.2. REESS adjustment

After preconditioning, soaking according to paragraph 2.1.3. of Appendix 4 to this annex shall be omitted and a break, during which the REESS is permitted to be adjusted, shall be set to a maximum duration of 60 minutes. A similar break shall be applied in advance of each test. Immediately after the end of this break, the requirements of paragraph 3.1.2.3. of this appendix shall be applied.

Upon request of the manufacturer, an additional warm-up procedure may be conducted in advance of the REESS adjustment to ensure similar starting conditions for the correction coefficient determination. If the manufacturer requests this additional warm-up procedure, the identical warm-up procedure shall be applied repeatedly within the test sequence.

3.1.2.3. Test procedure

3.1.2.3.1. The driver-selectable mode for the applicable WLTP test cycle shall be selected according to paragraph 3. of Appendix 6 to this annex.

3.1.2.3.2. For testing, the applicable WLTP test cycle according to paragraph 1.4.2. of this annex shall be driven.

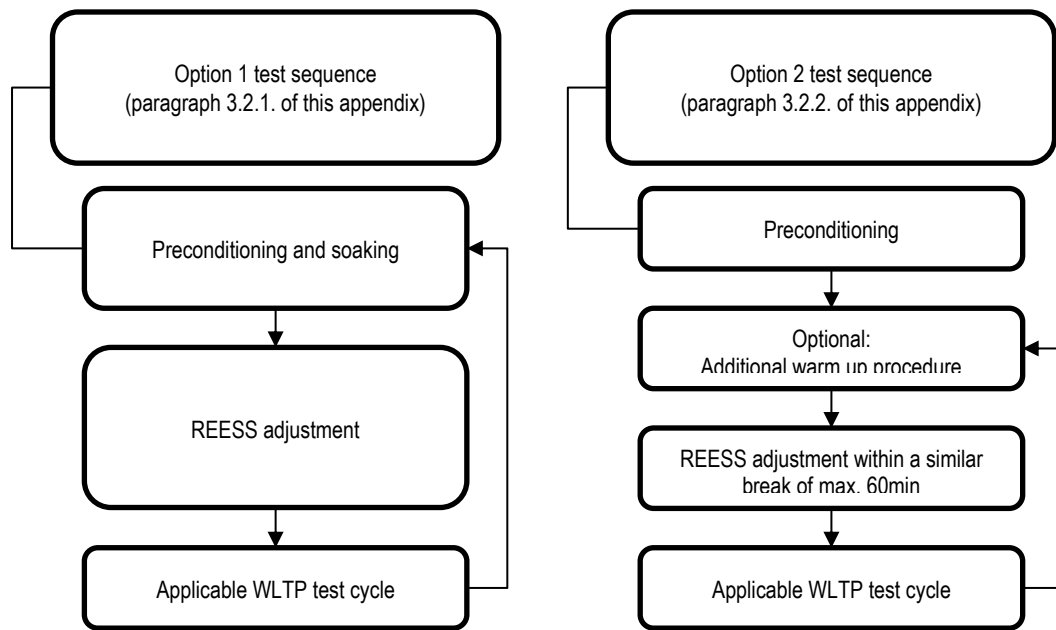
3.1.2.3.3. Unless stated otherwise in this appendix, the vehicle shall be tested according to the Type 1 test procedure described in Annex B6.

3.1.2.3.4. To obtain a set of applicable WLTP test cycles that are required for the determination of the correction coefficients, the test may be followed by a number of consecutive sequences required according to paragraph 2.2. of this appendix consisting of paragraphs 3.1.2.2. and 3.1.2.3. of this appendix.

3.2. NOVC-HEVs and NOVC-FCHVs

For NOVC-HEVs and NOVC-FCHVs, one of the following test sequences according to Figure A8.App2/2 shall be used to measure all values that are necessary for the determination of the correction coefficients according to paragraph 2. of this appendix.

Figure A8.App2/2
NOVC-HEV and NOVC-FCHV test sequences



3.2.1. Option 1 test sequence

3.2.1.1. Preconditioning and soaking

The test vehicle shall be preconditioned and soaked according to paragraph 3.3.1. of this annex.

3.2.1.2. REESS adjustment

Prior to the test procedure, according to paragraph 3.2.1.3. of this appendix, the manufacturer may adjust the REESS. The manufacturer shall provide evidence that the requirements for the beginning of the test according to paragraph 3.2.1.3. of this appendix are fulfilled.

3.2.1.3. Test procedure

3.2.1.3.1. The driver-selectable mode shall be selected according to paragraph 3. of Appendix 6 to this annex.

3.2.1.3.2. For testing, the applicable WLTP test cycle according to paragraph 1.4.2. of this annex shall be driven.

3.2.1.3.3. Unless stated otherwise in this appendix, the vehicle shall be tested according to the charge-sustaining Type 1 test procedure described in Annex B6.

3.2.1.3.4. To obtain a set of applicable WLTP test cycles that are required for the determination of the correction coefficients, the test can be followed by a number of consecutive sequences required according to paragraph 2.2. of this appendix consisting of paragraph 3.2.1.1. to paragraph 3.2.1.3. inclusive of this appendix.

3.2.2. Option 2 test sequence

3.2.2.1. Preconditioning

The test vehicle shall be preconditioned according to paragraph 3.3.1.1. of this annex.

3.2.2.2. REESS adjustment

After preconditioning, the soaking according to paragraph 3.3.1.2. of this annex shall be omitted and a break, during which the REESS is permitted to be adjusted, shall be set to a maximum duration of 60 minutes. A similar break

shall be applied in advance of each test. Immediately after the end of this break, the requirements of paragraph 3.2.2.3. of this appendix shall be applied.

Upon request of the manufacturer, an additional warm-up procedure may be conducted in advance of the REESS adjustment to ensure similar starting conditions for the correction coefficient determination. If the manufacturer requests this additional warm-up procedure, the identical warm-up procedure shall be applied repeatedly within the test sequence.

- 3.2.2.3. Test procedure
- 3.2.2.3.1. The driver-selectable mode for the applicable WLTP test cycle shall be selected according to paragraph 3. of Appendix 6 to this annex.
- 3.2.2.3.2. For testing, the applicable WLTP test cycle according to paragraph 1.4.2. of this annex shall be driven.
- 3.2.2.3.3. Unless stated otherwise in this appendix, the vehicle shall be tested according to the Type 1 test procedure described in Annex B6.
- 3.2.2.3.4. To get a set of applicable WLTP test cycles that are required for the determination of the correction coefficients, the test can be followed by a number of consecutive sequences required according to paragraph 2.2. of this appendix consisting of paragraphs 3.2.2.2. and 3.2.2.3. of this appendix.

Annex B8 - Appendix 3

Determination of REESS current and REESS voltage for NOVC-HEVs, OVC-HEVs, PEVs and NOVC-FCHVs

1. Introduction
 - 1.1. This appendix defines the method and required instrumentation to determine the REESS current and the REESS voltage of NOVC-HEVs, OVC-HEVs, PEVs and NOVC-FCHVs.
 - 1.2. Measurement of REESS current and REESS voltage shall start at the same time as the test starts and shall end immediately after the vehicle has finished the test.
 - 1.3. The REESS current and the REESS voltage of each phase shall be determined.
 - 1.4. A list of the instrumentation used by the manufacturer to measure REESS voltage and current (including instrument manufacturer, model number, serial number, last calibration dates (where applicable)) during:
 - (a) The Type 1 test according to paragraph 3 of this annex;
 - (b) The procedure to determine the correction coefficients according to Appendix 2 of this annex (where applicable);
 - (c) For the 4-phase WLTP only;
The Ambient Temperature Correction Test (ATCT) as specified in Annex B6ashall be provided to the responsible authority.
2. REESS current

REESS depletion is considered as a negative current.

 - 2.1. External REESS current measurement
 - 2.1.1. The REESS current(s) shall be measured during the tests using a clamp-on or closed type current transducer. The current measurement system shall fulfil the requirements specified in Table A8/1 of this annex. The current transducer(s) shall be capable of handling the peak currents at engine starts and temperature conditions at the point of measurement.

In order to have an accurate measurement, zero adjustment and degaussing shall be performed before the test according to the instrument manufacturer's instructions.
 - 2.1.2. Current transducers shall be fitted to any of the REESS on one of the cables connected directly to the REESS and shall include the total REESS current.

In case of shielded wires, appropriate methods shall be applied in accordance with the responsible authority.

In order to easily measure the REESS current using external measuring equipment, the manufacturer should provide appropriate, safe and accessible connection points in the vehicle. If that is not feasible, the manufacturer is obliged to support the responsible authority in connecting a current transducer to one of the cables directly connected to the REESS in the manner described above in this paragraph.
 - 2.1.3. The current transducer output shall be sampled with a minimum frequency of 20 Hz. The measured current shall be integrated over time, yielding the measured value of Q, expressed in ampere-hours Ah. The integration may be done in the current measurement system.

- 2.2. Vehicle on-board REESS current data
- As an alternative to paragraph 2.1. of this appendix, the manufacturer may use on-board REESS current measurement data. The accuracy of these data shall be demonstrated to the responsible authority.
3. REESS voltage
- 3.1. External REESS voltage measurement
- During the tests described in paragraph 3. of this annex, the REESS voltage shall be measured with the equipment and accuracy requirements specified in paragraph 1.1. of this annex. To measure the REESS voltage using external measuring equipment, the manufacturers shall support the responsible authority by providing REESS voltage measurement points and safety instructions.
- 3.2. Nominal REESS voltage
- For NOVC-HEVs, NOVC-FCHVs and OVC-HEVs, instead of using the measured REESS voltage according to paragraph 3.1. of this appendix, the nominal voltage of the REESS determined according to IEC 60050-482 may be used.
- 3.3. Vehicle on-board REESS voltage data
- As an alternative to paragraphs 3.1. and 3.2. of this appendix, the manufacturer may use the on-board voltage measurement data. The accuracy of these data shall be demonstrated to the responsible authority.
- 3.4. Restrictions in the application of instantaneous voltage
- In the following situations, the application of the instantaneous voltage according to paragraphs 3.1. and 3.3. of this appendix is prohibited and the nominal REESS voltage determined according to the standard referenced in paragraph 3.2. of this appendix shall be used:
- (a) During the development of the REESS energy change-based correction factor defined in Appendix 2 to this annex;
 - (b) For the calculation of charge-sustaining CO₂ mass emission for OVC-HEVs and NOVC-HEVs as described in paragraphs 4.1.1.3. to 4.1.1.5. inclusive of this annex;
 - (c) For the calculation of charge-sustaining fuel consumption for NOVC-FCHVs as described in paragraphs 4.2.1.2.3. to 4.2.1.2.5. inclusive of this annex.

Annex B8 - Appendix 4

Preconditioning, soaking and REESS charging conditions of PEVs and OVC-HEVs

1. This appendix describes the test procedure for REESS and combustion engine preconditioning in preparation for:
 - (a) Electric range, charge-depleting and charge-sustaining measurements when testing OVC-HEVs; and
 - (b) Electric range measurements as well as electric energy consumption measurements when testing PEVs.
2. OVC-HEV preconditioning and soaking
 - 2.1. Preconditioning and soaking when the test procedure starts with a charge-sustaining test
 - 2.1.1. For preconditioning the combustion engine, the vehicle shall be driven over at least one applicable WLTP test cycle. During each driven preconditioning cycle, the charging balance of the REESS shall be determined. The preconditioning shall be stopped at the end of the applicable WLTP test cycle during which the break-off criterion is fulfilled according to paragraph 3.2.4.5. of this annex.
 - 2.1.2. As an alternative to paragraph 2.1.1. of this appendix, at the request of the manufacturer and upon approval of the responsible authority, the state of charge of the REESS for the charge-sustaining Type 1 test may be set according to the manufacturer's recommendation in order to achieve a test under charge-sustaining operating condition.

In such a case, a preconditioning procedure, such as that applicable to pure ICE vehicles as described in paragraph 2.6. of Annex B6, shall be applied.
 - 2.1.3. Soaking of the vehicle shall be performed according to paragraph 2.7. of Annex B6.
 - 2.2. Preconditioning and soaking when the test procedure starts with a charge-depleting test
 - 2.2.1. OVC-HEVs shall be driven over at least one applicable WLTP test cycle. During each driven preconditioning cycle, the charging balance of the REESS shall be determined. The preconditioning shall be stopped at the end of the applicable WLTP test cycle during which the break-off criterion is fulfilled according to paragraph 3.2.4.5. of this annex.
 - 2.2.2. Soaking of the vehicle shall be performed according to paragraph 2.7. of Annex B6. Forced cooling down shall not be applied to vehicles preconditioned for the Type 1 test. During soak, the REESS shall be charged using the normal charging procedure as defined in paragraph 2.2.3. of this appendix.
 - 2.2.3. Application of a normal charge

Normal charging is the transfer of electricity to an electrified vehicle with a power of less than or equal to 22 kW.

Where there are several possible methods to perform a normal AC charge (e.g. cable, induction, etc.), the charging procedure via cable shall be used.

Where there are several AC charging power levels available, the highest normal charging power shall be used. An AC charging power lower than the highest normal AC charging power may be selected if recommended by the manufacturer and by approval of the responsible authority.

2.2.3.1. The REESS shall be charged at an ambient temperature as specified in paragraph 2.2.2.2. of Annex B6 with the on-board charger if fitted.

In the following cases, a charger recommended by the manufacturer and using the charging pattern prescribed for normal charging shall be used if:

- (a) No on-board charger is fitted, or
- (b) The charging time exceeds the soaking time defined in paragraph 2.7. of Annex B6.

The procedures in this paragraph exclude all types of special charges that could be automatically or manually initiated, e.g. equalization charges or servicing charges. The manufacturer shall declare that, during the test, a special charge procedure has not occurred.

2.2.3.2. End-of-charge criterion

The end-of-charge criterion is reached when the on-board or external instruments indicate that the REESS is fully charged. If the charging is performed during soaking and finished before the minimum required soaking time as defined in paragraph 2.7. of Annex B6, the vehicle shall stay connected to the grid at least until the minimum required soaking time is reached.

3. PEV preconditioning and soaking

3.1. Initial charging of the REESS

Initial charging of the REESS consists of discharging the REESS and applying a normal charge.

3.1.1. Discharging the REESS

The discharge procedure shall be performed according to the manufacturer's recommendation. The manufacturer shall guarantee that the REESS is as fully depleted as is possible by the discharge procedure.

3.1.2. Soaking and application of a normal charge

Soaking of the vehicle shall be performed in accordance with paragraph 2.7. of Annex B6.

During soak, the REESS shall be charged using the normal charging procedure as defined in paragraph 2.2.3. of this appendix.

Annex B8 - Appendix 5

Utility factors (UF) for OVC-HEVs

1. Each Contracting Party may develop its own UFs.
2. The methodology recommended for the determination of a UF curve based on driving statistics is described in SAE J2841 (Sept. 2010, Issued 2009-03, Revised 2010-09).
3. For the calculation of a fractional utility factor UF_j for the weighting of period j , the following equation shall be applied by using the coefficients from Table A8.App5/1.

$$UF_j(d_j) = 1 - \exp \left\{ - \left(\sum_{i=1}^k C_i \times \left(\frac{d_j}{d_n} \right)^i \right) \right\} - \sum_{i=1}^{j-1} UF_i$$

where:

- UF_j utility factor for period j ;
- d_j measured distance driven at the end of period j , km;
- C_i i^{th} coefficient (see Table A8.App5/1);
- d_n normalized distance (see Table A8.App5/1), km;
- k number of terms and coefficients in the exponent;
- j number of period considered;
- i number of considered term/coefficient;
- $\sum_{i=1}^{j-1} UF_i$ sum of calculated utility factors up to period $(j-1)$.

Table A8.App5/1

Parameters for the determination of fractional UFs (as applicable)

Parameter	For the 4-phase WLTP only
d_n	800 km
C1	26.25
C2	-38.94
C3	-631.05
C4	5964.83
C5	-25095
C6	60380.2
C7	-87517
C8	75513.8
C9	-35749
C10	7154.94

Annex B8 - Appendix 6

Selection of driver-selectable modes

1. General requirement
 - 1.1. The manufacturer shall select the driver-selectable mode for the Type 1 test procedure according to paragraphs 2. to 4. inclusive of this appendix which enables the vehicle to follow the considered test cycle within the speed trace tolerances according to paragraph 2.6.8.3.1.2. of Annex B6. This shall apply to all vehicle systems with driver-selectable modes including those not solely specific to the transmission.
 - 1.2. The manufacturer shall provide evidence to the responsible authority concerning:
 - (a) The availability of a predominant mode under the considered conditions;
 - (b) The maximum speed of the considered vehicle;
and if required:
 - (c) The best and worst case mode identified by the evidence on the fuel consumption and, if applicable, on the CO₂ mass emission/fuel consumption in all modes. See paragraph 2.6.6.3. of Annex B6;
 - (d) The highest electric energy consuming mode;
 - (e) The cycle energy demand (according to paragraph 5 of Annex B7 where the target speed is replaced by the actual speed).
 - 1.3. Dedicated driver-selectable modes, such as "mountain mode" or "maintenance mode" which are not intended for normal daily operation but only for special limited purposes, shall not be considered.
2. OVC-HEVs equipped with a driver-selectable mode under charge-depleting operating condition

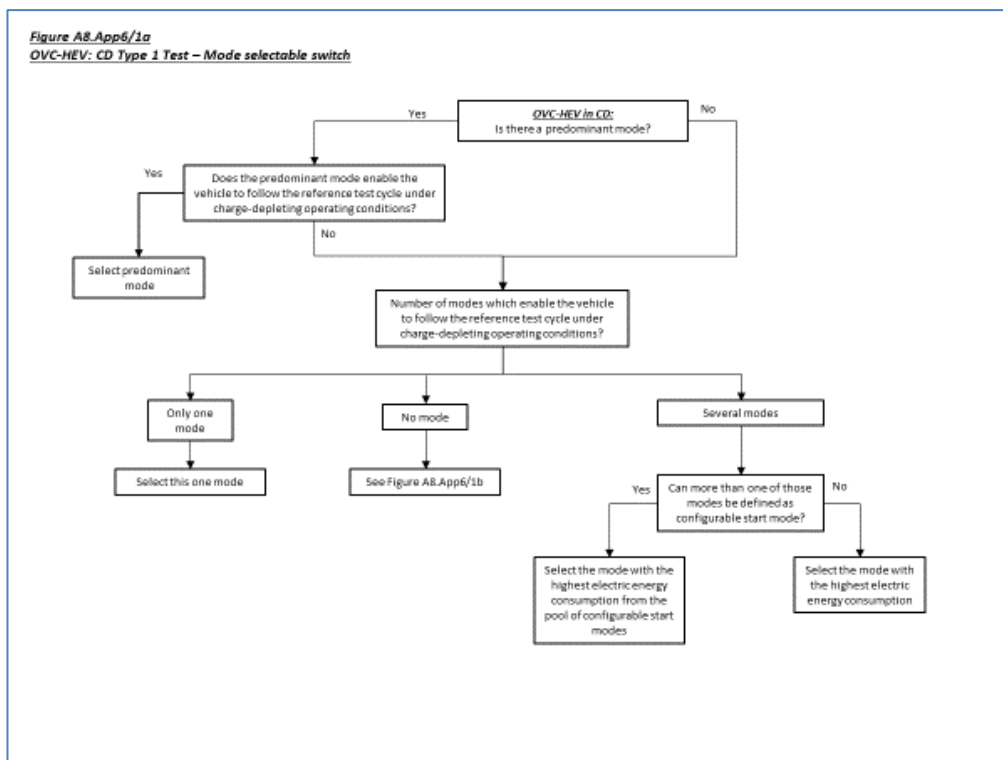
For vehicles equipped with a driver-selectable mode, the mode for the charge-depleting Type 1 test shall be selected according to the following conditions.

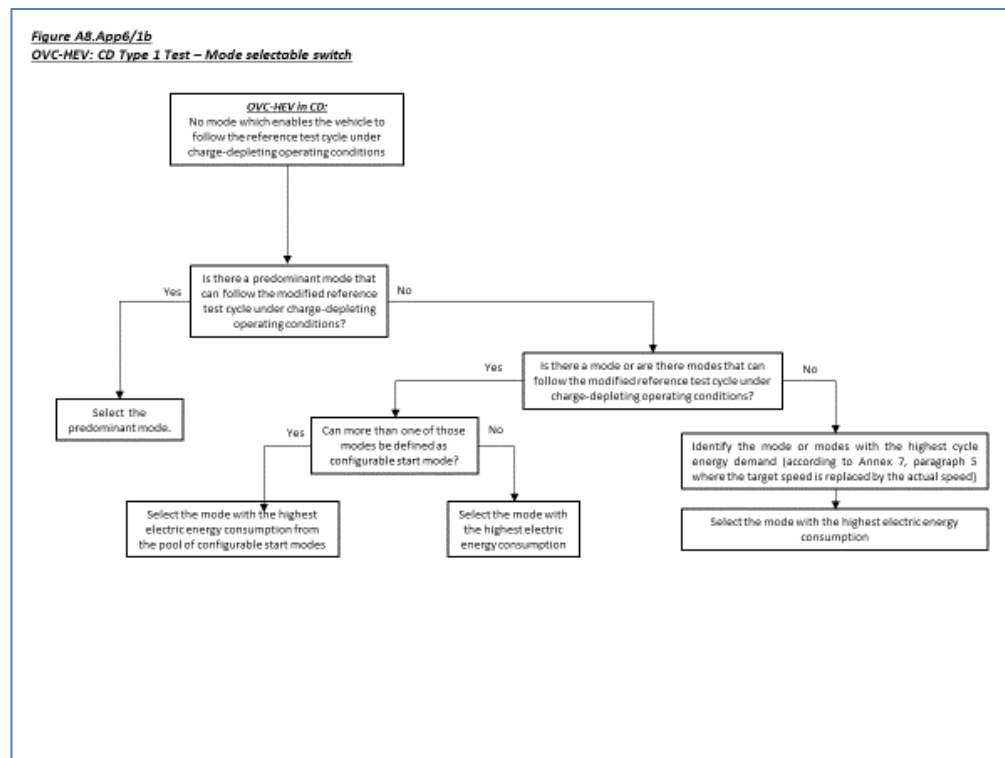
The flow chart in Figure A8.App6/1 illustrates the mode selection according to this paragraph.

 - 2.1. If there is a predominant mode that enables the vehicle to follow the reference test cycle under charge-depleting operating condition, this mode shall be selected.
 - 2.2. If there is no predominant mode or if there is a predominant mode but this mode does not enable the vehicle to follow the reference test cycle under charge-depleting operating condition, the mode for the test shall be selected according to the following conditions:
 - (a) If there is only one mode which allows the vehicle to follow the reference test cycle under charge-depleting operating conditions, this mode shall be selected;
 - (b) If several modes are capable of following the reference test cycle under charge-depleting operating conditions and none of those modes is a configurable start mode, the worst case mode for electric energy consumption of those modes shall be selected;
 - (c) If several modes are capable of following the reference test cycle under charge-depleting operating conditions and at least two of those modes are a configurable start mode, the worst case mode for electric energy consumption shall be selected from these configurable start modes.

- 2.3. If there is no mode according to paragraph 2.1. and paragraph 2.2. of this appendix that enables the vehicle to follow the reference test cycle, the reference test cycle shall be modified according to paragraph 9 of Annex B1:
- (a) If there is a predominant mode which allows the vehicle to follow the modified reference test cycle under charge-depleting operating conditions, this mode shall be selected.
 - (b) If there is no predominant mode but other modes which allow the vehicle to follow the modified reference test cycle under charge-depleting operating condition, the worst case mode for electric energy consumption of those modes shall be selected. In the case that at least two or more configurable start modes, the worst case mode for electric energy consumption shall be selected from these configurable start modes;
 - (c) If there is no mode which allows the vehicle to follow the modified reference test cycle under charge-depleting operating condition, the mode or modes with the highest cycle energy demand shall be identified and the worst case mode for electric energy consumption shall be selected.

Figure A8.App6/1a and Figure A8.App6/1b
Selection of driver-selectable mode for OVC-HEVs under charge-depleting operating condition





3. OVC-HEVs, NOVC-HEVs and NOVC-FCHVs equipped with a driver-selectable mode under charge-sustaining operating condition

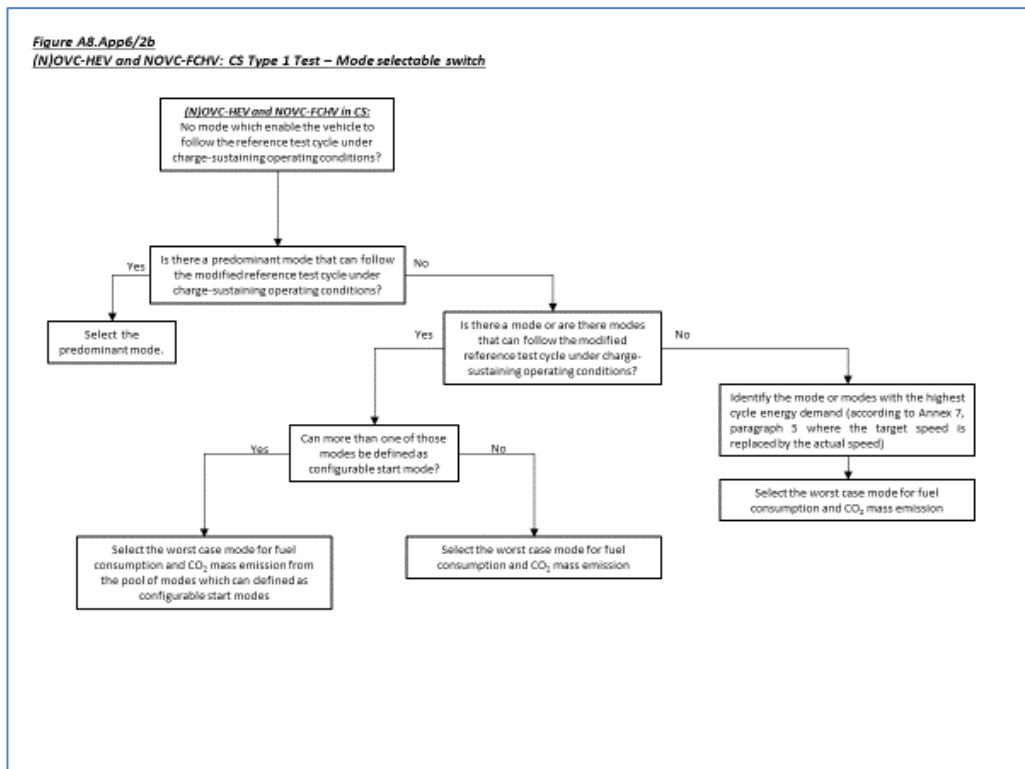
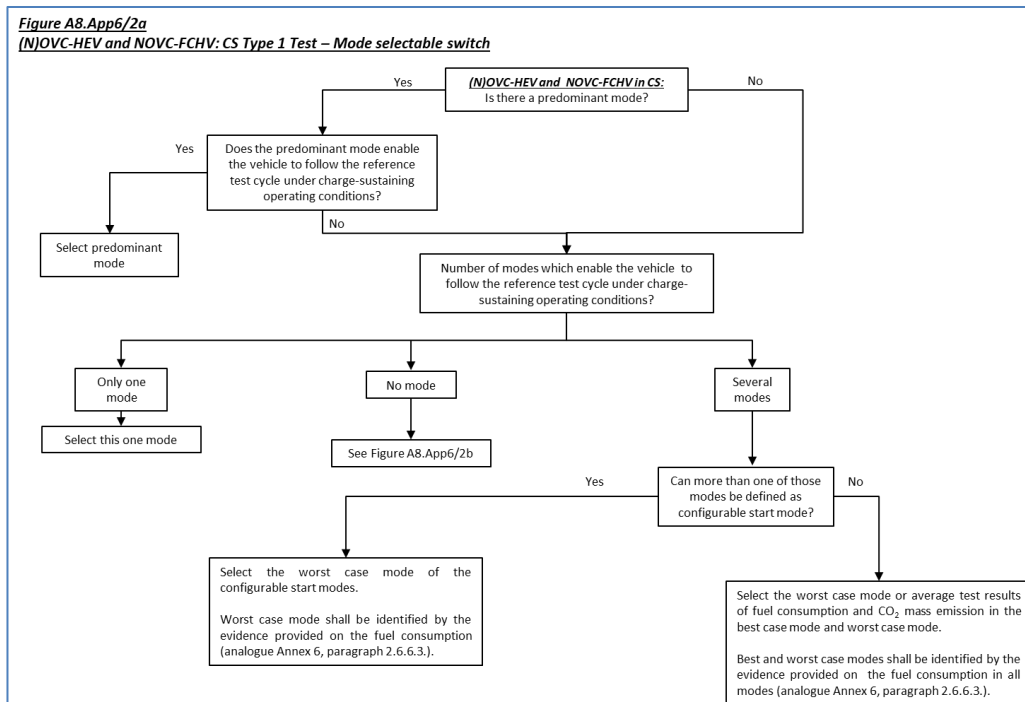
For vehicles equipped with a driver-selectable mode, the mode for the charge-sustaining Type 1 test shall be selected according to the following conditions.

The flow chart in Figure A8.App6/2 illustrates the mode selection according to this paragraph.

- 3.1. If there is a predominant mode that enables the vehicle to follow the reference test cycle under charge-sustaining operating condition, this mode shall be selected.
- 3.2. If there is no predominant mode or if there is a predominant mode but this mode does not enable the vehicle to follow the reference test cycle under charge-sustaining operating condition, the mode for the test shall be selected according to the following conditions:
- If there is only one mode which allows the vehicle to follow the reference test cycle under charge-sustaining operating conditions, this mode shall be selected;
 - If several modes are capable of following the reference test cycle under charge-sustaining operating conditions and none of those modes is a configurable start mode, the worst case mode for CO₂ emissions and fuel consumption shall be selected;
 - If several modes are capable of following the reference test cycle under charge-sustaining operating conditions and at least two or more of those modes are a configurable start mode, the worst case mode for CO₂ emissions and fuel consumption shall be selected.
- 3.3. If there is no mode according to paragraph 3.1. and paragraph 3.2. of this appendix that enables the vehicle to follow the reference test cycle, the reference test cycle shall be modified according to paragraph 9. of Annex B1:
- If there is a predominant mode which allows the vehicle to follow the modified reference test cycle under charge-sustaining operating condition, this mode shall be selected.

- (b) If there is no predominant mode but other modes which allow the vehicle to follow the modified reference test cycle under charge-sustaining operating condition, the worst case mode for CO₂ emissions and fuel consumption of these modes shall be selected.
- (c) If there is no mode which allows the vehicle to follow the modified reference test cycle under charge-sustaining operating condition, the mode or modes with the highest cycle energy demand shall be identified and the worst case mode for CO₂ emissions and fuel consumption of those modes shall be selected. In the case that at least two or more of these modes are a configurable start mode, the worst case mode for CO₂ emissions and fuel consumption shall be selected from these modes.

Figure A8.App6/2a and Figure A8.App6/2b
Selection of a driver-selectable mode for OVC-HEVs, NOVC-HEVs and NOVC-FCHVs under charge-sustaining operating condition



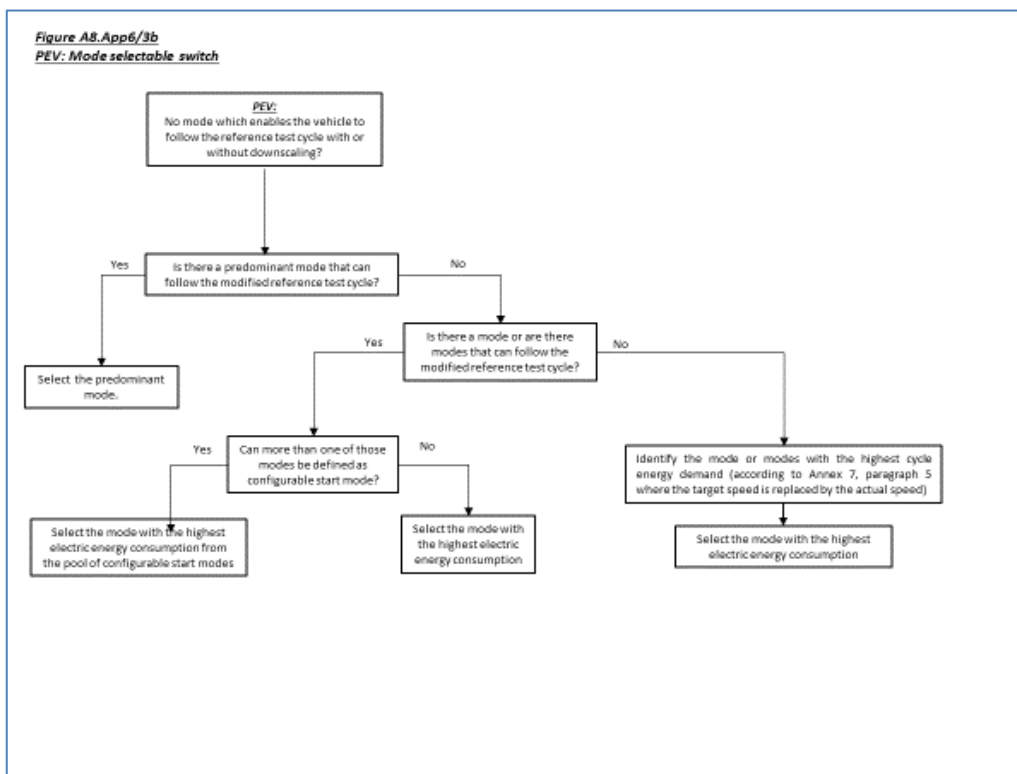
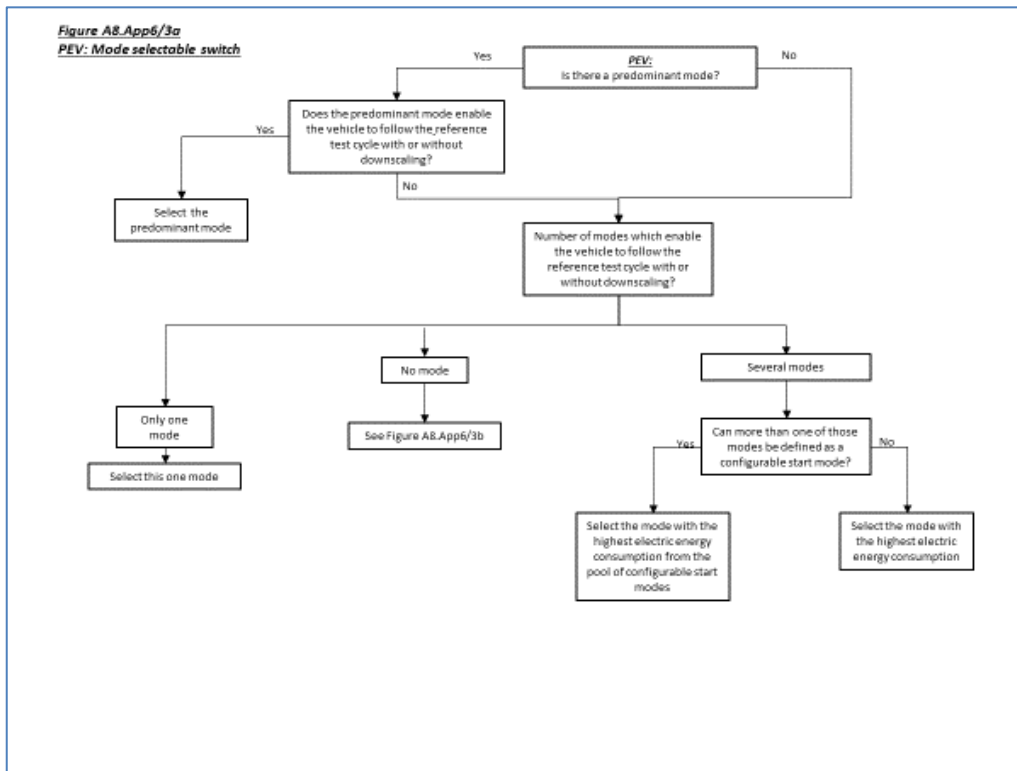
4. PEVs equipped with a driver-selectable mode

For vehicles equipped with a driver-selectable mode, the mode for the test shall be selected according to the following conditions.

The flow chart in Figure A8.App6/3 illustrates the mode selection according to this paragraph.
- 4.1. If there is a predominant mode that enables the vehicle to follow the reference test cycle, this mode shall be selected.

- 4.2. If there is no predominant mode or if there is a predominant mode but this mode does not enable the vehicle to follow the reference test cycle, the mode for the test shall be selected according to the following conditions:
- (a) If there is only one mode which allows the vehicle to follow the reference test cycle, this mode shall be selected;
 - (b) If several modes are capable of following the reference test cycle and none of those modes is a configurable start mode, the worst case mode for electric energy consumption of those modes shall be selected;
 - (c) If several modes are capable of following the reference test cycle, and at least two of those modes are a configurable start mode, the worst case mode for electric energy consumption shall be selected from these configurable start modes.
- 4.3. If there is no mode according to paragraph 4.1. and paragraph 4.2. of this appendix that enables the vehicle to follow the reference test cycle, the reference test cycle shall be modified according to paragraph 9. of Annex B1. The resulting test cycle shall be named as the applicable WLTP test cycle:
- (a) If there is a predominant mode which allows the vehicle to follow the modified reference test cycle, this mode shall be selected;
 - (b) If there is no predominant mode but other modes which allow the vehicle to follow the modified reference test cycle, worst case mode for electric energy consumption of those modes shall be selected. In the case that at least two or more configurable start modes, the worst case mode for electric energy consumption shall be selected from these configurable start modes;
 - (c) If there is no mode which allows the vehicle to follow the modified reference test cycle, the mode or modes with the highest cycle energy demand shall be identified and the worst case mode for electric energy consumption shall be selected.

Figure A8.App6/3a and Figure A8.App6/3b
Selection of the driver-selectable mode for PEVs



Annex B8 - Appendix 7

Fuel consumption measurement of compressed hydrogen fuel cell hybrid vehicles

1. General requirements

Fuel consumption shall be measured using the gravimetric method in accordance with paragraph 2. of this appendix.

At the request of the manufacturer and with approval of the responsible authority, fuel consumption may be measured using either the pressure method or the flow method. In this case, the manufacturer shall provide technical evidence that the method yields equivalent results. The pressure and flow methods are described in ISO 23828.

2. Gravimetric method

Fuel consumption shall be calculated by measuring the mass of the fuel tank before and after the test.

2.1. Equipment and setting

2.1.1. An example of the instrumentation is shown in Figure A8.App7/1. One or more off-vehicle tanks shall be used to measure the fuel consumption. The off-vehicle tank(s) shall be connected to the vehicle fuel line between the original fuel tank and the fuel cell system.

2.1.2. For preconditioning, the originally installed tank or an external source of hydrogen may be used.

2.1.3. The refuelling pressure shall be adjusted to the manufacturer's recommended value.

2.1.4. Difference of the gas supply pressures in lines shall be minimized when the lines are switched.

In the case that influence of pressure difference is expected, the manufacturer and the responsible authority shall agree whether correction is necessary or not.

2.1.5. Balance

2.1.5.1. The balance used for fuel consumption measurement shall meet the specification of Table A8.App7/1.

Table A8.App7/1

Analytical balance verification criteria

<i>Measurement system</i>	<i>Resolution</i>	<i>Precision</i>
Balance	0.1 g maximum	±0.02 maximum ^(a)

^(a) Fuel consumption (REESS charge balance = 0) during the test, in mass, standard deviation

2.1.5.2. The balance shall be calibrated in accordance with the specifications provided by the balance manufacturer or at least as often as specified in Table A8.App7/2.

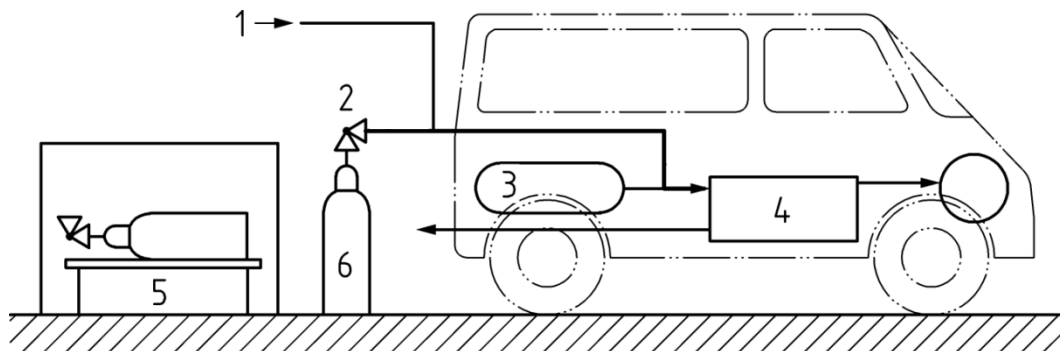
Table A8.App7/2

Instrument calibration intervals

<i>Instrument checks</i>	<i>Interval</i>
Precision	Yearly and at major maintenance

2.1.5.3. Appropriate means for reducing the effects of vibration and convection, such as a damping table or a wind barrier, shall be provided.

Figure A8.App7/1

Example of instrumentation

where:

- 1 is the external fuel supply for preconditioning
- 2 is the pressure regulator
- 3 is the original tank
- 4 is the fuel cell system
- 5 is the balance
- 6 is/are off-vehicle tank(s) for fuel consumption measurement

2.2. Test procedure

- 2.2.1. The mass of the off-vehicle tank shall be measured before the test.
- 2.2.2. The off-vehicle tank shall be connected to the vehicle fuel line as shown in Figure A8.App7/1.
- 2.2.3. The test shall be conducted by fuelling from the off-vehicle tank.
- 2.2.4. The off-vehicle tank shall be removed from the line.
- 2.2.5. The mass of the tank and fuel consumed after the test shall be measured.
- 2.2.5.1. At the request of the manufacturer and with approval of the responsible authority, the change in weight of the hydrogen in the auxiliary line between points 2 and 4 in Figure A8.App7/1 due to changes in temperature and pressure may be taken into consideration.
- 2.2.6. The non-balanced charge-sustaining fuel consumption $FC_{CS,nb}$ from the measured mass before and after the test shall be calculated using the following equation:

$$FC_{CS,nb} = \frac{g_1 - g_2}{d} \times 100$$

where:

- $FC_{CS,nb}$ is the non-balanced charge-sustaining fuel consumption measured during the test, kg/100 km;
- g_1 is the mass of the tank at the start of the test, kg;

g_2 is the mass of the tank at the end of the test, kg;

d is the distance driven during the test, km.

- 2.2.7. Separate fuel consumption $FC_{CS,nb,p}$ as defined in paragraphs 4.2.1.2.4. and 4.2.1.2.5. of this annex shall be calculated for each individual phase in accordance with paragraph 2.2. of this appendix. The test procedure shall be conducted with off-vehicle tanks and connections to the vehicle fuel line which are individually prepared for each phase.

Annex B8 - Appendix 8

Calculation of additional values required for checking the Conformity of Production of electric energy consumption of PEVs and OVC-HEVs

For the conformity of production, specific values are required to be provided and of which the calculation is described in this Appendix.

1. Calculation of electric energy consumption values of PEVs for conformity of production

- 1.1. The following value shall be declared and used for verifying the conformity of production with respect to the electric energy consumption of PEVs:

$$EC_{DC-i,COP} = EC_{DC,first,i} \times AF_{EC,i}$$

where:

i is representing – in the case the interpolation method is applied – the index L for vehicle L and the index H for vehicle H. In the case the interpolation method is not applied, index i is representing the vehicle tested and paragraph 1.2. of this appendix shall be omitted.

$EC_{DC-i,COP}$ is the electric energy consumption of vehicle i based on the REESS depletion of the first applicable WLTC test cycle provided for the verification during the conformity of production test procedure;

$EC_{DC,first,i}$ is the electric energy consumption of vehicle i based on the REESS depletion of the first applicable WLTC test cycle according to paragraph 4.3. of this annex, in Wh/km;

$AF_{EC,i}$ is the adjustment factor of vehicle i which compensates the difference between the charge-depleting electric energy consumption value declared after having performed the Type 1 test procedure during type approval and the measured test result determined during the conformity of production procedure

and

$$AF_{EC,i} = \frac{EC_{WLTC,declared,i}}{EC_{WLTC,i}}$$

where

$EC_{WLTC,declared,i}$ is the declared electric energy consumption of vehicle i for PEVs according to paragraph 1.2.3. of Annex B6 .

$EC_{WLTC,i}$ is the measured electric energy consumption of vehicle i according to paragraph 4.3.4.2. of this annex.

In the case, the interpolation method is applied, the values declared and used for verifying the conformity of production with respect to the electric energy consumption of vehicle H and vehicle L shall be the input values for the interpolation of the individual electric energy consumption values according to paragraph 1.2. of this appendix.

- 1.2. Interpolation of the individual electric energy consumption value of PEVs

This paragraph shall only be applied in the case the interpolation method is applied. The interpolated electric energy consumption value shall be declared

and used for verifying the conformity of production with respect to the electric energy consumption of the individual vehicle:

$$EC_{DC-ind,COP} = EC_{DC-L,COP} + K_{ind} \times (EC_{DC-H,COP} - EC_{DC-L,COP})$$

where:

$EC_{DC-ind,COP}$	is the electric energy consumption of an individual vehicle for the conformity of production, Wh/km;
$EC_{DC-L,COP}$	is the electric energy consumption of vehicle L for the conformity of production determined according to paragraph 1.1. of this appendix, Wh/km;
$EC_{DC-H,COP}$	is the electric energy consumption of vehicle H for the conformity of production determined according to paragraph 1.1. of this appendix, Wh/km;
K_{ind}	is the interpolation coefficient for the considered individual vehicle for the applicable WLTP test cycle, according to paragraph 4.5.3. of this annex.

2. Calculation of electric energy consumption values of OVC-HEVs for conformity of production

This paragraph shall only be applied if there is no engine start in the first cycle of the charge-depleting Type 1 test during Type Approval. In the case there is an engine start, this paragraph shall be omitted.

2.1. The following value shall be declared and used for verifying the conformity of production with respect to electric energy consumption value of OVC-HEVs:

$$EC_{DC,CD-i,COP} = EC_{DC,CD,first,i} \times AF_{EC,AC,CD,i}$$

where:

i	is representing – in the case the interpolation method is applied – the index L for vehicle L and the index H for vehicle H. In the case the interpolation method is not applied, index i is representing the vehicle tested and paragraph 2.2. of this appendix shall be omitted.
$EC_{DC,CD-i,COP}$	is the charge-depleting electric energy consumption based on the REESS depletion of the first applicable WLTC test cycle of the charge-depleting Type 1 test provided for the verification during the conformity of production test procedure;
$EC_{DC,CD,first,i}$	is the charge-depleting electric energy consumption of vehicle i based on the REESS depletion of the first applicable WLTC test cycle of the charge-depleting Type 1 test according to paragraph 4.3. of this annex, Wh/km;
$AF_{EC,AC,CD,i}$	is the adjustment factor of vehicle i for the charge-depleting electric energy consumption which compensates the difference between the value declared after having performed the Type 1 test procedure during type approval and the measured test result determined during the conformity of production procedure.

and

For 4-phase WLTP test

$$AF_{EC,AC,CD,i} = \frac{EC_{AC,CD,declared,i}}{EC_{AC,CD,i}}$$

where

$EC_{AC,CD,declared,i}$ is the declared charge-depleting electric energy consumption of vehicle i of the charge-depleting Type 1 test according to paragraph 1.2.3. of Annex B6.

$EC_{AC,CD,i}$ is the measured charge-depleting electric energy consumption of vehicle i of the charge-depleting Type 1 test according to paragraph 4.3.1. of this annex.

For 3-phase WLTP test

$$AF_{EC,AC,CD,i} = \frac{EC_{declared,i}}{EC_i}$$

where

$EC_{declared,i}$ is the declared electric energy consumption of vehicle i of the charge-depleting Type 1 test according to paragraph 1.2.3. of Annex B6.

EC_i is the measured electric energy consumption of vehicle i of the charge-depleting Type 1 test according to paragraph 4.3.3.1. of this annex.

In the case, the interpolation method is applied, the values declared and used for verifying the conformity of production with respect to the electric energy consumption of vehicle H and vehicle L shall be the input values for the interpolation of the individual electric energy consumption values according to paragraph 2.2. of this appendix.

2.2. Interpolation of the individual charge-depleting electric energy consumption value

This paragraph shall only be applied in the case the interpolation method is applied. The interpolated electric energy consumption value shall be declared and used for verifying the conformity of production with respect to the electric energy consumption value of the individual vehicle:

$$EC_{DC-ind,CD,COP} = EC_{DC-L,CD,COP} + K_{ind} \times (EC_{DC-H,CD,COP} - EC_{DC-L,CD,COP})$$

where:

$EC_{DC-ind,CD,COP}$ is the charge-depleting electric energy consumption of an individual vehicle for the conformity of production, Wh/km;

$EC_{DC-L,CD,COP}$ is the charge-depleting electric energy consumption of vehicle L for the conformity of production determined according to paragraph 2.1. of this appendix, Wh/km;

$EC_{DC-H,CD,COP}$ is the charge-depleting electric energy consumption of vehicle H for the conformity of production determined according to paragraph 2.1. of this appendix, Wh/km;

K_{ind} is the interpolation coefficient for the considered individual vehicle for the applicable WLTP test cycle, according to paragraph 4.5.3. of this annex.

Annexes Part C

Annex C1: [Reserved]

Annex C2: [Reserved]

Annex C3: Type 4 test

Determination of evaporative emissions from vehicles fuelled with petrol

Type 4 test procedures and test conditions

1. Introduction

This annex provides the method to determine the levels of evaporative emission from light-duty vehicles in a repeatable and reproducible manner designed to be representative of real world vehicle operation..

2. Technical requirements

2.1. The procedure includes the evaporative emissions test and two additional tests, one for the ageing of carbon canisters, as described in paragraph 5.1. of this annex, and one for the permeability of the fuel tank system, as described in paragraph 5.2. of this annex. The evaporative emissions test (Figure C3/4) determines hydrocarbon evaporative emissions as a consequence of diurnal temperature fluctuations and hot soaks during parking.

2.2. In the case that the fuel system contains more than one carbon canister, all references to the term "carbon canister" in this annex will apply to each carbon canister.

3. Vehicle

The vehicle shall be in good mechanical condition and have been run-in and driven at least 3,000 km before the test. For the purpose of the determination of evaporative emissions, the mileage and the age of the vehicle used for certification shall be recorded. The evaporative emission control system shall be connected and functioning correctly during the run-in period. The aged carbon canister shall not be installed during the run-in period.

A carbon canister aged according to the procedure described in paragraphs 5.1. to 5.1.3.1.3. inclusive of this annex shall not be installed until the start of the fuel drain and refill procedure specified in paragraph 6.5.1. of this annex.

4. Test equipment, calibration requirements and intervals

Unless stated otherwise in this paragraph, equipment used for testing shall be calibrated before its initial use and at appropriate service intervals thereafter. An appropriate service interval shall be either equipment manufacturer recommendation or according to good engineering practice.

4.1. Chassis dynamometer

The chassis dynamometer shall meet the requirements of paragraphs 2. to 2.4.2. inclusive of Annex B5.

4.2. Evaporative emission measurement enclosure

The evaporative emission measurement enclosure shall be a gas-tight rectangular measuring chamber able to contain the vehicle under test. The vehicle shall be accessible from all sides and the enclosure when sealed shall be gas-tight in accordance with paragraph 4.2.3.3. of this annex. The inner surface of the enclosure shall be impermeable and non-reactive to hydrocarbons. The temperature conditioning system shall be capable of controlling the internal enclosure air temperature to follow the prescribed temperature versus time profile throughout the test, and an average tolerance of 1 °C over the duration of the test.

The control system shall be tuned to provide a smooth temperature pattern that has a minimum of overshoot, hunting, and instability about the desired long-term ambient temperature profile. Interior surface temperatures shall not be less than 5 °C nor more than 55 °C at any time during the diurnal emission test.

Wall design shall be such as to promote good dissipation of heat. Interior surface temperatures shall not be below 20 °C, nor above 52 °C for the duration of the hot soak rest.

To accommodate the volume changes due to enclosure temperature changes, either a variable-volume or fixed-volume enclosure may be used.

4.2.1. Variable-volume enclosure

The variable-volume enclosure expands and contracts in response to the temperature change of the air mass in the enclosure. Two potential means of accommodating the internal volume changes are movable panel(s), or a bellows design, in which an impermeable bag or bags inside the enclosure expand(s) and contract(s) in response to internal pressure changes by exchanging air from outside the enclosure. Any design for volume accommodation shall maintain the integrity of the enclosure as specified in paragraph 4.2.3. of this annex over the specified temperature range.

Any method of volume accommodation shall limit the differential between the enclosure internal pressure and the barometric pressure to a maximum value of ± 0.5 kPa.

The enclosure shall be capable of latching to a fixed volume. A variable volume enclosure shall be capable of accommodating a +7 per cent change from its "nominal volume" (see paragraph 4.2.3.1.1. of this annex), taking into account temperature and barometric pressure variation during testing.

4.2.2. Fixed-volume enclosure

The fixed-volume enclosure shall be constructed with rigid panels that maintain a fixed enclosure volume, and meet the requirements below.

4.2.2.1. The enclosure shall be equipped with an outlet flow stream that withdraws air at a low, constant rate from the enclosure throughout the test. An inlet flow stream may provide make-up air to balance the outgoing flow with incoming ambient air. Inlet air shall be filtered with activated carbon to provide a relatively constant hydrocarbon level. Any method of volume accommodation shall maintain the differential between the enclosure internal pressure and the barometric pressure between 0 and -0.5 kPa.

4.2.2.2. The equipment shall be capable of measuring the mass of hydrocarbon in the inlet and outlet flow streams with a resolution of 0.01 gram. A bag sampling system may be used to collect a proportional sample of the air withdrawn from and admitted to the enclosure. Alternatively, the inlet and outlet flow streams may be continuously analysed using an on-line FID analyser and integrated with the flow measurements to provide a continuous record of the mass hydrocarbon removal.

4.2.3. Calibration of the enclosure

4.2.3.1. Initial determination of internal volume of the enclosure

4.2.3.1.1. Before its initial use, the internal volume of the chamber shall be determined as follows:

The internal dimensions of the chamber are carefully measured, allowing for any irregularities such as bracing struts. The internal volume of the chamber is determined from these measurements.

For variable-volume enclosures, the enclosure shall be latched to a fixed volume when the enclosure is held at an ambient temperature of 30 °C or at the

choice of the manufacturer 29 °C. This nominal volume shall be repeatable within ± 0.5 per cent of the reported value.

- 4.2.3.1.2. The net internal volume is determined by subtracting 1.42 m³ from the internal volume of the chamber. Alternatively the volume of the test vehicle with the luggage compartment and windows open may be used instead of the 1.42 m³.
- 4.2.3.1.3. The chamber shall be checked as in paragraph 4.2.3.3. of this annex. If the propane mass does not correspond to the injected mass to within ± 2 per cent, then corrective action is required.
- 4.2.3.2. Determination of chamber background emissions
- This operation determines that the chamber does not contain any materials that emit significant amounts of hydrocarbons. The check shall be carried out at the enclosure's introduction to service, after any operations in the enclosure which may affect background emissions and at a frequency of at least once per year.
- 4.2.3.2.1. Variable-volume enclosures may be operated in either latched or unlatched volume configuration, as described in paragraph 4.2.3.1.1. of this annex, ambient temperatures shall be maintained at $35\text{ °C} \pm 2\text{ °C}$, or at the choice of the manufacturer $36\text{ °C} \pm 2\text{ °C}$, throughout the 4-hour period mentioned below.
- 4.2.3.2.2. Fixed volume enclosures shall be operated with the inlet and outlet flow streams closed. Ambient temperatures shall be maintained at $35\text{ °C} \pm 2\text{ °C}$, or at the choice of the manufacturer $36\text{ °C} \pm 2\text{ °C}$, throughout the 4-hour period mentioned below.
- 4.2.3.2.3. The enclosure may be sealed and the mixing fan operated for a period of up to 12 hours before the 4-hour background sampling period begins.
- 4.2.3.2.4. The analyser (if required) shall be calibrated, then zeroed and spanned.
- 4.2.3.2.5. The enclosure shall be purged until a stable hydrocarbon reading is obtained, and the mixing fan turned on if not already on.
- 4.2.3.2.6. The chamber is then sealed and the background hydrocarbon concentration, temperature and barometric pressure are measured. These are the initial readings C_{HCl} , P_i , T_i used in the enclosure background calculation.
- 4.2.3.2.7. The enclosure is allowed to stand undisturbed with the mixing fan on for a period of four hours.
- 4.2.3.2.8. At the end of this time the same analyser is used to measure the hydrocarbon concentration in the chamber. The temperature and the barometric pressure are also measured. These are the final readings C_{HCf} , P_f , T_f .
- 4.2.3.2.9. The change in mass of hydrocarbons in the enclosure shall be calculated over the time of the test in accordance with paragraph 4.2.3.4. of this annex and shall not exceed 0.05 g.
- 4.2.3.3. Calibration and hydrocarbon retention test of the chamber
- The calibration and hydrocarbon retention test in the chamber provides a check on the calculated volume in paragraph 4.2.3.1. of this annex and also measures any leak rate. The enclosure leak rate shall be determined at the enclosure's introduction to service, after any operations in the enclosure which may affect the integrity of the enclosure, and at least monthly thereafter. If six consecutive monthly retention checks are successfully completed without corrective action, the enclosure leak rate may be determined quarterly thereafter as long as no corrective action is required.
- 4.2.3.3.1. The enclosure shall be purged until a stable hydrocarbon concentration is reached. The mixing fan is turned on, if not already switched on. The hydrocarbon analyser is zeroed, calibrated if required, and spanned.

- 4.2.3.3.2. On variable-volume enclosures, the enclosure shall be latched to the nominal volume position. On fixed-volume enclosures the outlet and inlet flow streams shall be closed.
- 4.2.3.3.3. The ambient temperature control system is then turned on (if not already on) and adjusted for an initial temperature of 35 °C, or at the choice of the manufacturer 36 °C.
- 4.2.3.3.4. When the enclosure stabilises at 35 °C ± 2 °C, or at the choice of the manufacturer 36 °C ± 2 °C, the enclosure is sealed and the background concentration, temperature and barometric pressure measured. These are the initial readings C_{HCi} , P_i , T_i used in the enclosure calibration.
- 4.2.3.3.5. A quantity of approximately 4 grams of propane is injected into the enclosure. The mass of propane shall be measured to an accuracy and precision of ±2 per cent of the measured value.
- 4.2.3.3.6. The contents of the chamber shall be allowed to mix for five minutes and then the hydrocarbon concentration, temperature and barometric pressure are measured. These are the readings C_{HCf} , P_f , T_f for the calibration of the enclosure as well as the initial readings C_{HCi} , P_i , T_i for the retention check.
- 4.2.3.3.7. Based on the readings taken according to paragraph 4.2.3.3.4. and 4.2.3.3.6. of this annex and the formula in paragraph 4.2.3.4. of this annex, the mass of propane in the enclosure is calculated. This shall be within ±2 per cent of the mass of propane measured in paragraph 4.2.3.3.5. of this annex.
- 4.2.3.3.8. For variable-volume enclosures the enclosure shall be unlatched from the nominal volume configuration. For fixed-volume enclosures, the outlet and inlet flow streams shall be opened.
- 4.2.3.3.9. The process is then begun of cycling the ambient temperature from 35 °C to 20 °C and back to 35 °C, or at the choice of the manufacturer 35.6 °C to 22.2 °C and back to 35.6 °C, over a 24-hour period according to the profile, or the alternative profile, specified in paragraph 6.5.9. of this annex within 15 minutes of sealing the enclosure. (Tolerances as specified in paragraph 6.5.9.1. of this annex.)
- 4.2.3.3.10. At the completion of the 24-hour cycling period, the final hydrocarbon concentration, temperature and barometric pressure are measured and recorded. These are the final readings C_{HCf} , P_f , T_f for the hydrocarbon retention check.
- 4.2.3.3.11. Using the formula in paragraph 4.2.3.4. of this annex, the hydrocarbon mass is then calculated from the readings taken in paragraphs 4.2.3.3.6. and 4.2.3.3.10. of this annex. The mass may not differ by more than 3 per cent from the hydrocarbon mass given in paragraph 4.2.3.3.7. of this annex.

4.2.3.4. Calculations

The calculation of net hydrocarbon mass change within the enclosure is used to determine the chamber's hydrocarbon background and leak rate. Initial and final readings of hydrocarbon concentration, temperature and barometric pressure are used in the following formula to calculate the mass change.

The calculation shall be undertaken in accordance in paragraph 7. of this annex, using the following value for V .

V is the net enclosure volume, m³.

4.3. Analytical systems

The analytical systems shall meet the requirements of paragraphs 4.3.1. to 4.3.3. of this annex.

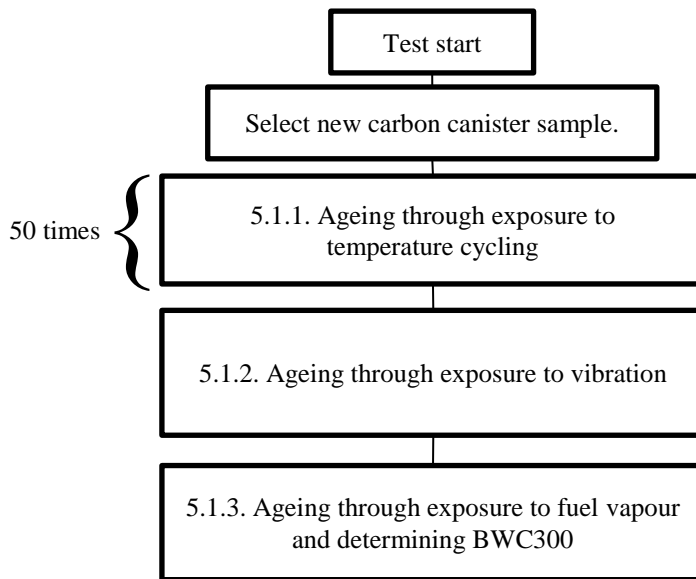
Continuous measuring of hydrocarbons is not mandatory unless the fixed volume type enclosure is used.

- 4.3.1. Hydrocarbon analyser
- 4.3.1.1. The atmosphere within the chamber is monitored using a hydrocarbon detector of the FID type. Sample gas shall be drawn from the mid-point of one side wall or roof of the chamber and any bypass flow shall be returned to the enclosure, preferably to a point immediately downstream of the mixing fan.
- 4.3.1.2. The hydrocarbon analyser shall have a response time to 90 per cent of final reading of less than 1.5 seconds. Its stability shall be better than 2 per cent of full scale at zero and at 80 ± 20 per cent of full scale over a 15-minute period for all operational ranges.
- 4.3.1.3. The repeatability of the analyser expressed as one standard deviation shall be better than ± 1 per cent of full scale deflection at zero and at 80 ± 20 per cent of full scale on all ranges used.
- 4.3.1.4. The operational ranges of the analyser shall be chosen to give best resolution over the measurement, calibration and leak checking procedures.
- 4.3.2. Hydrocarbon analyser data recording system
- 4.3.2.1. The hydrocarbon analyser shall be fitted with a device to record electrical signal output either by strip chart recorder or other data processing system at a frequency of at least once per minute. The recording system shall have operating characteristics at least equivalent to the signal being recorded and shall provide a permanent record of results. The record shall show a positive indication of the beginning and end of the hot soak or diurnal emission test (including beginning and end of sampling periods along with the time elapsed between start and completion of each test).
- 4.3.3. Checking of FID hydrocarbon analyser
- 4.3.3.1. Detector response optimisation
- The FID shall be adjusted as specified by the instrument manufacturer. Propane in air should be used to optimise the response on the most common operating range.
- 4.3.3.2. Calibration of the hydrocarbon analyser
- The analyser should be calibrated using propane in air and purified synthetic air. See paragraph 6.2. of Annex B5 of this Regulation.
- Each of the normally used operating ranges are calibrated in accordance with paragraphs 4.3.3.2.1. to 4.3.3.2.4. of this annex.
- 4.3.3.2.1. Establish the calibration curve by at least five calibration points spaced as evenly as possible over the operating range. The nominal concentration of the calibration gas with the highest concentrations to be at least 80 per cent of the full scale.
- 4.3.3.2.2. Calculate the calibration curve by the method of least squares. If the resulting polynomial degree is greater than 3, then the number of calibration points shall be at least the number of the polynomial degree plus 2.
- 4.3.3.2.3. The calibration curve shall not differ by more than 2 per cent from the nominal value of each calibration gas.
- 4.3.3.2.4. Using the coefficients of the polynomial derived from paragraph 5 of Annex B5, a table of indicated reading against true concentration shall be drawn up in steps of no greater than 1 per cent of full scale. This is to be carried out for each analyser range calibrated. The table shall also contain other relevant data such as:
- (a) Date of calibration, span and zero potentiometer readings (where applicable);
 - (b) Nominal scale;

- (c) Reference data of each calibration gas used;
 - (d) The actual and indicated value of each calibration gas used together with the percentage differences;
 - (e) FID fuel and type;
 - (f) FID air pressure.
- 4.3.3.2.5. If it can be shown to the satisfaction of the responsible authority that alternative technology (e.g. computer, electronically controlled range switch) can give equivalent accuracy, then those alternatives may be used.
- 4.4. Temperature recording system
- The temperature recording system shall meet the requirements of paragraphs 4.4.1. to 4.4.5. of this annex.
- 4.4.1. The temperature in the chamber is recorded at two points by temperature sensors which are connected so as to show a mean value. The measuring points are extended approximately 0.1 m into the enclosure from the vertical centre line of each side wall at a height of 0.9 ± 0.2 m.
- 4.4.2. The temperatures of the fuel tank(s) are recorded by means of the sensor positioned in the fuel tank as in paragraph 6.1.1. of this annex in the case of use of the gasoline canister load option (paragraph 6.5.5.3. of this annex).
- 4.4.3. Temperatures shall, throughout the evaporative emission measurements, be recorded or entered into a data processing system at a frequency of at least once per minute.
- 4.4.4. The accuracy of the temperature recording system shall be within ± 1.0 K and the temperature shall be capable of being resolved to ± 0.4 K.
- 4.4.5. The recording or data processing system shall be capable of resolving time to ± 15 seconds.
- 4.5. Pressure recording system
- The pressure recording system shall meet the requirements of paragraphs 4.5.1. to 4.5.3.
- 4.5.1. The difference Δp between barometric pressure within the test area and the enclosure internal pressure shall, throughout the evaporative emission measurements, be recorded or entered into a data processing system at a frequency of at least once per minute.
- 4.5.2. The accuracy of the pressure recording system shall be within ± 0.3 kPa and the pressure shall be capable of being resolved to ± 0.025 kPa.
- 4.5.3. The recording or data processing system shall be capable of resolving time to ± 15 seconds.
- 4.6. Fans
- The fans shall meet the requirements of paragraphs 4.6.1. and 4.6.2. of this annex.
- 4.6.1. By the use of one or more fans or blowers with the Sealed Housing Evaporative Determination (SHED) door(s) open, it shall be possible to reduce the hydrocarbons concentration in the chamber to the ambient hydrocarbon level.
- 4.6.2. The chamber shall have one or more fans or blowers of like capacity 0.1 to 0.5 m³/sec. with which to thoroughly mix the atmosphere in the enclosure. It shall be possible to attain an even temperature and hydrocarbon concentration in the chamber during measurements. The vehicle in the enclosure shall not be subjected to a direct stream of air from the fans or blowers.

- 4.7. Calibration gases
- The gases shall meet the requirements of paragraphs 4.7.1. and 4.7.2. of this annex.
- 4.7.1. The following pure gases shall be available for calibration and operation:
- Purified synthetic air: (purity < 1 ppm C₁ equivalent,
≤ 1 ppm CO, ≤ 400 ppm CO₂, ≤ 0.1 ppm NO);
- Oxygen content between 18 and 21 per cent by volume.
- Hydrocarbon analyser fuel gas: (40 ± 2 per cent hydrogen, and balance helium with less than 1 ppm C₁ equivalent hydrocarbon, less than 400 ppm CO₂),
- Propane (C₃H₈): 99.5 per cent minimum purity.
- Butane (C₄H₁₀): 98 per cent minimum purity.
- Nitrogen (N₂): 98 per cent minimum purity.
- 4.7.2. Calibration and span gases shall be available containing mixtures of propane (C₃H₈) and purified synthetic air. The true concentrations of a calibration gas shall be within 2 per cent of the stated figures. The accuracy of the diluted gases obtained when using a gas divider shall be to within ±2 per cent of the true value. The concentrations specified in paragraphs 4.2.3. and 4.3.3. of this annex may also be obtained by the use of a gas divider using synthetic air as the dilutant gas.
- 4.8. Carbon canister weighing scale for depressurisation puff loss overflow measurement
- The carbon canister weighing scale shall have an accuracy of ±0.02 g.
- 4.9. Fuel tank heating (only applicable for gasoline canister load option)
- 4.9.1. The fuel in the vehicle tank(s) shall be heated by a controllable source of heat; for example a heating pad of 2,000 W capacity is suitable. The heating system shall apply heat evenly to the tank walls beneath the level of the fuel so as not to cause local overheating of the fuel. Heat shall not be applied to the vapour in the tank above the fuel.
- 4.9.2. The tank heating device shall make it possible to heat the fuel in the tank evenly by 14 °C from 16 °C within 60 minutes, with the temperature sensor position as in paragraph 4.9.3. of this annex. The heating system shall be capable of controlling the fuel temperature to ±1.5 °C of the required temperature during the tank heating process.
- 4.9.3. The fuel tank of the vehicle shall, without introducing any leaks, be equipped with a temperature sensor to enable the temperature to be measured at the mid-point of the fuel in the fuel tank when filled to 40 per cent of its capacity.
5. Procedure for carbon canister bench ageing and PF determination
- 5.1. Carbon canister bench ageing
- Before performing the hot soak and diurnal losses sequences, the carbon canister shall be aged according to the procedure described in Figure C3/1.

Figure C3/1
Carbon canister bench ageing procedure



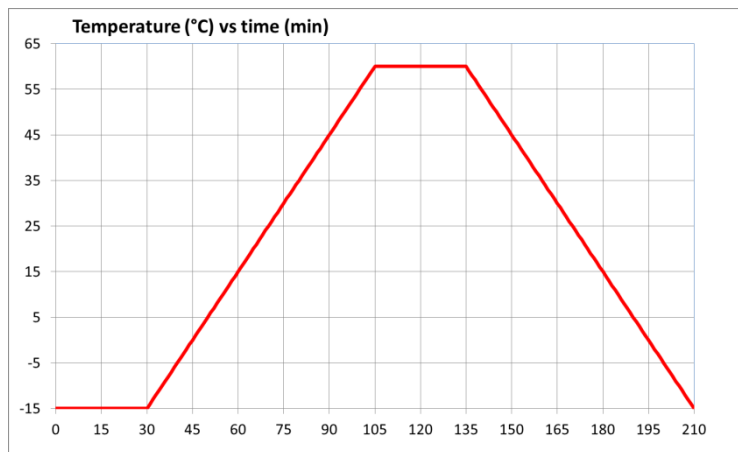
5.1.1. Ageing through exposure to temperature cycling

The carbon canister shall be cycled between temperatures from -15 °C to 60 °C in a dedicated temperature enclosure with 30 minutes of stabilisation at -15 °C and 60 °C. Each cycle shall last 210 minutes (see Figure C3/2).

The temperature gradient shall be as close as possible to 1 °C/min. No forced air flow should pass through the carbon canister.

The cycle shall be repeated 50 times consecutively. In total, this procedure lasts 175 hours.

Figure C3/2
Temperature conditioning cycle



5.1.2. Ageing through exposure to vibration

Following the temperature ageing procedure, the carbon canister shall be shaken vertically with the carbon canister mounted as per its orientation in the vehicle with an overall Grms (root mean square acceleration) > 1.5 m/sec² with a frequency of 30 ±10 Hz. The test shall last 12 hours.

5.1.3. Ageing through exposure to fuel vapour and determining BWC300

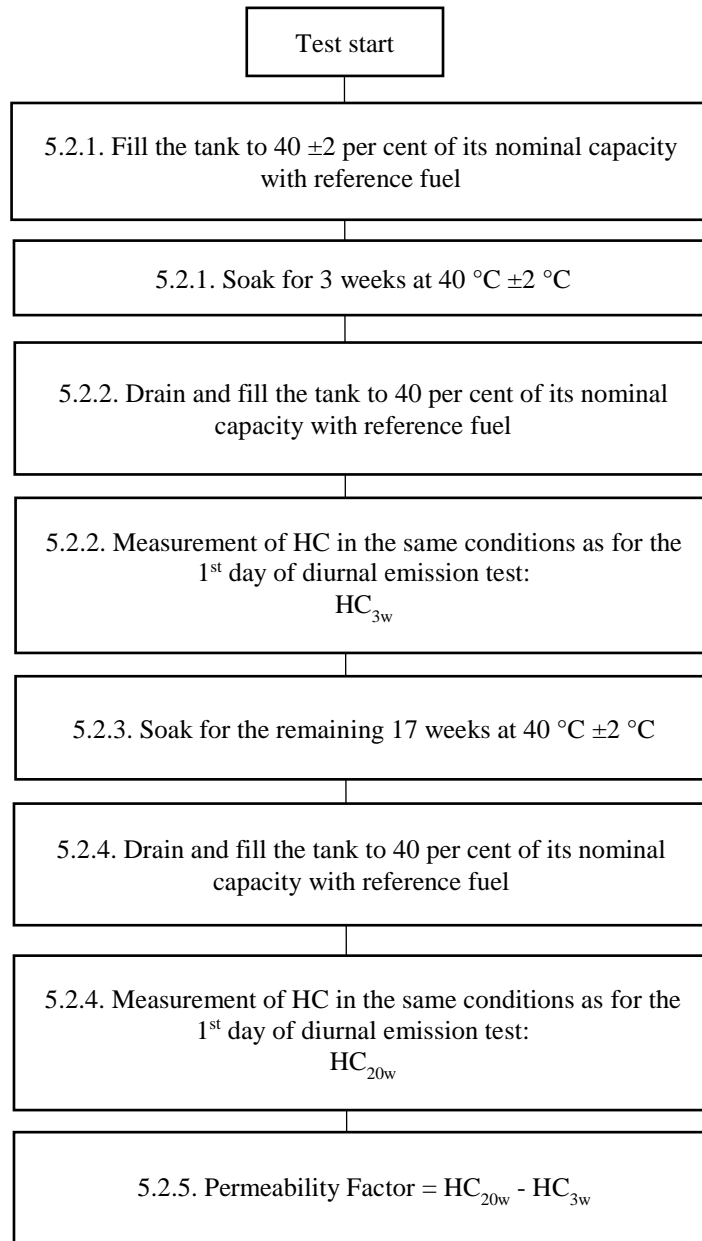
5.1.3.1. Ageing shall consist of repeatedly loading with fuel vapour and purging with laboratory air.

- 5.1.3.1.1. After temperature and vibration ageing, the carbon canister shall be further aged with a mixture of market fuel as specified in paragraph 5.1.3.1.1.1. of this annex and nitrogen or air with a 50 ± 15 per cent fuel vapour volume. The fuel vapour fill rate shall be 60 ± 20 g/h.
- The carbon canister shall be loaded to 2 gram breakthrough. Alternatively, loading shall be considered to be completed when the hydrocarbon concentration level at the vent outlet reaches 3,000 ppm.
- 5.1.3.1.1.1. The market fuel used for this test shall fulfil the same requirements as a reference fuel with respect to:
- Density at 15 °C;
 - Vapour pressure;
 - Distillation (70 °C, 100 °C, 150 °C);
 - Hydrocarbon analysis (olefins, aromatics, benzene only);
 - Oxygen content;
 - Ethanol content.
- 5.1.3.1.2. The carbon canister shall be purged between 5 and 60 minutes after loading with 25 ± 5 litres per minute of emission laboratory air until 300 bed volume exchanges are reached.
- 5.1.3.1.3. The procedures set out in paragraphs 5.1.3.1.1. and 5.1.3.1.2. of this annex shall be repeated 300 times after which the carbon canister shall be considered to be stabilised.
- 5.1.3.1.4. The procedure to measure the butane working capacity (BWC) with respect to the evaporative emission family in paragraph 6.6.3. of this Regulation shall consist of the following.
- The stabilised carbon canister shall be loaded to 2 gram breakthrough and subsequently purged a minimum of 5 times. Loading shall be performed with a mixture composed of 50 per cent butane and 50 per cent nitrogen by volume at a rate of 40 grams butane per hour.
 - Purging shall be performed according to paragraph 5.1.3.1.2. of this annex.
 - The BWC shall be recorded after each loading.
 - BWC300 shall be calculated as the average of the last 5 BWCs.
- 5.1.3.2. If the aged carbon canister is provided by a supplier, the vehicle manufacturer shall inform the responsible authority in advance of the ageing process to enable the witnessing of any part of that process.
- 5.1.3.3. The manufacturer shall provide the responsible authority a test report including at least the following elements:
- Type of activated carbon;
 - Loading rate;
 - Fuel specifications.

5.2. Determination of the PF of the fuel tank system (see Figure C3/3)

Figure C3/3

Determination of PF



5.2.1. The fuel tank system representative of a family shall be selected and mounted on a rig in a similar orientation as in the vehicle. The tank shall be filled to 40 ± 2 per cent of its nominal capacity with reference fuel at a temperature of 18 °C ± 2 °C. The rig with the fuel tank system shall be placed in a room with a controlled temperature of 40 °C ± 2 °C for 3 weeks.

5.2.2. At the end of the third week, the tank shall be drained and refilled with reference fuel at a temperature of 18 °C ± 2 °C to 40 ± 2 per cent of its nominal capacity.

Within 6 to 36 hours, the rig with the fuel tank system shall be placed in an enclosure. The last 6 hours of this period shall be at an ambient temperature of 20 °C ± 2 °C. In the enclosure, a diurnal procedure shall be performed over the first 24-hour period of the procedure described in paragraph 6.5.9. of this annex. The fuel vapour in the tank shall be vented to the outside of the enclosure to eliminate the possibility of the tank venting emissions being

counted as permeation. The HC emissions shall be measured and the value shall be recorded as HC_{3W}.

5.2.3. The rig with the fuel tank system shall be placed again in a room with a controlled temperature of 40 °C ±2 °C for the remaining 17 weeks.

5.2.4. At the end of the seventeenth week, the tank shall be drained and refilled with reference fuel at a temperature of 18 °C ±2 °C to 40 ±2 per cent of its nominal tank capacity.

Within 6 to 36 hours, the rig with the fuel tank system shall be placed in an enclosure. The last 6 hours of this period shall be at an ambient temperature of 20 °C ±2 °C. In the enclosure, a diurnal procedure shall be performed over a first period of 24 hours of the procedure described according to paragraph 6.5.9. of this annex. The fuel tank system shall be vented to the outside of the enclosure to eliminate the possibility of the tank venting emissions being counted as permeation. The HC emissions shall be measured and the value shall be recorded in this case as HC_{20W}.

5.2.5. The PF is the difference between HC_{20W} and HC_{3W} in g/24h calculated to 3 significant digits using the following equation:

$$PF = HC_{20W} - HC_{3W}$$

5.2.6. If the PF is determined by a supplier, the vehicle manufacturer shall inform the responsible authority in advance of the determination to allow witness check in the supplier's facility.

5.2.7. The manufacturer shall provide the responsible authority with a test report containing at least the following:

- (a) A full description of the fuel tank system tested, including information on the type of tank tested, whether the tank is metal, monolayer non-metal or multilayer, and which types of materials are used for the tank and other parts of the fuel tank system;
- (b) The weekly mean temperatures at which the ageing was performed;
- (c) The HC measured at week 3 (HC_{3W});
- (d) The HC measured at week 20 (HC_{20W});
- (e) The resulting permeability factor (PF).

5.2.8. As an alternative to paragraphs 5.2.1. to 5.2.7. inclusive of this annex, a manufacturer using multilayer tanks or metal tanks may choose to use an Assigned Permeability Factor (APF) instead of performing the complete measurement procedure mentioned above:

$$APF \text{ multilayer/metal tank} = 120 \text{ mg /24 h}$$

Where the manufacturer chooses to use an APF, the manufacturer shall provide the responsible authority with a declaration in which the type of tank is clearly specified as well as a declaration of the type of materials used.

6. Test procedure for the measurement of hot soak and diurnal losses

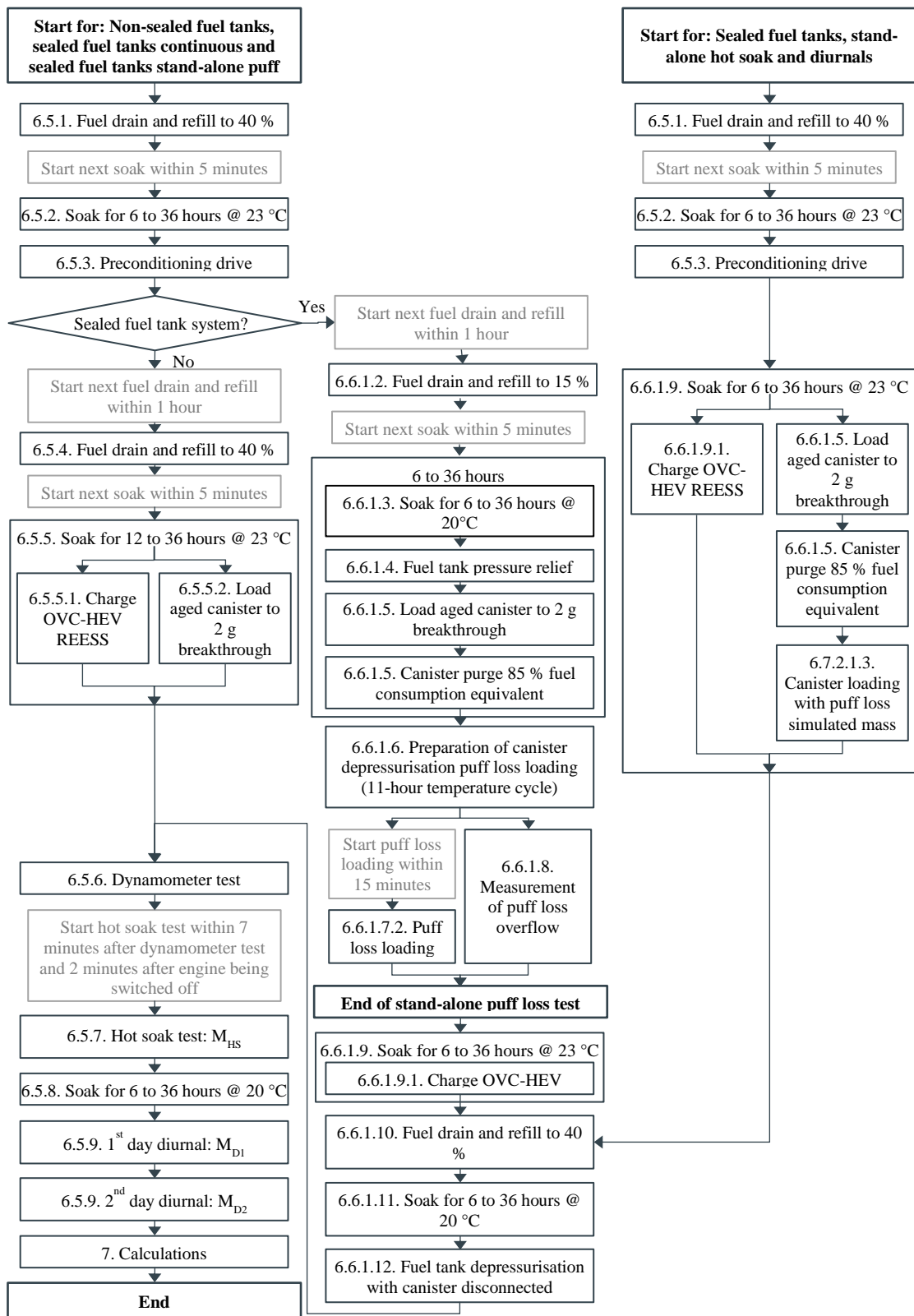
6.1. Vehicle preparation

The vehicle shall be prepared in accordance with paragraphs 6.1.1. and 6.1.2. of this annex. At the request of the manufacturer and with approval of the responsible authority, non-fuel background emission sources (e.g. paint, adhesives, plastics, fuel/vapour lines, tyres, and other rubber or polymer components) may be reduced to typical vehicle background levels before testing (e.g. baking of tyres at temperatures of 50 °C or higher for appropriate periods, baking of the vehicle, draining washer fluid).

For a sealed fuel tank system, the vehicle carbon canisters shall be installed so that access to carbon canisters and connection/disconnection of carbon canisters can be done easily.

- 6.1.1. The vehicle shall be mechanically prepared before the test as follows:
- (a) The exhaust system of the vehicle shall not exhibit any leaks;
 - (b) The vehicle may be steam-cleaned before the test;
 - (c) In the case of use of the gasoline canister load option (paragraph 6.5.5.3. of this annex) the fuel tank of the vehicle shall be equipped with a temperature sensor to enable the temperature to be measured at the mid-point of the fuel in the fuel tank when filled to 40 per cent of its capacity;
 - (d) Additional fittings, adapters or devices may be fitted to the fuel system in order to allow a complete draining of the fuel tank. For this purpose it is not necessary to modify the shell of the tank;
 - (e) The manufacturer may propose a test method in order to take into account the loss of hydrocarbons by evaporation coming only from the fuel system of the vehicle.
- 6.1.2. The vehicle is taken into the test area where the ambient temperature is between 20 and 30 °C.
- 6.2. Mode selections and gear shift prescriptions
- 6.2.1. For vehicles with manual shift transmissions, the gear shift prescriptions specified in Annex B2 shall apply.
- 6.2.2. In the case of pure ICE vehicles, the mode shall be selected according to Annex B6.
- 6.2.3. In the case of NOVC-HEVs and OVC-HEVs, the mode shall be selected according to Appendix 6 to Annex B8.
- 6.2.4. Upon request of the responsible authority, the selected mode may be different from that described in paragraphs 6.2.2. and 6.2.3. of this annex.
- 6.3. Test conditions
- The tests included in this annex shall be performed using the test conditions specific to interpolation family vehicle H with the highest cycle energy demand of all the interpolation families included in the evaporative emission family being considered.
- Otherwise, at the request of the responsible authority, any cycle energy representative of a vehicle in the family may be used for the test.
- 6.4. Flow of the test procedure
- The test procedure for non-sealed and sealed tank systems shall be followed according to the flow chart described in Figure C3/4.
- The sealed fuel tank systems shall be tested with one of 2 options. One option is to test the vehicle with one continuous procedure. Another option, called the 'stand-alone test procedure', is to test the vehicle with two separate procedures which will allow repeating the dynamometer test and the diurnal tests without repeating the tank depressurisation puff loss overflow test and the depressurisation puff loss measurement.

Figure C3/4
Test procedure flow charts



6.5. Continuous test procedure for non-sealed fuel tank systems

6.5.1. Fuel drain and refill

The fuel tank of the vehicle shall be emptied. This shall be done so as not to abnormally purge or abnormally load the evaporative control devices fitted to

the vehicle. Removal of the fuel cap is normally sufficient to achieve this. The fuel tank shall be refilled with reference fuel at a temperature of $18\text{ °C} \pm 2\text{ °C}$ to 40 ± 2 per cent of its nominal capacity.

6.5.2. Soak

Within 5 minutes after completing the fuel drain and refill, the vehicle shall be soaked for a minimum of 6 hours and a maximum of 36 hours at $23\text{ °C} \pm 3\text{ °C}$.

6.5.3. Preconditioning drive

The vehicle shall be placed on a chassis dynamometer and driven over the following phases of the cycle described in Annex B1:

- (a) For Class 1 vehicles:
low, medium, low, low, medium, low
- (b) For Class 2 and 3 vehicles: low, medium, high, medium.

For OVC-HEVs, the preconditioning drive shall be performed under the charge-sustaining operating condition as defined in paragraph 3.3.6. of this Regulation. Upon the request of responsible authority, any other mode may be used.

6.5.4. Fuel drain and refill

Within one hour after the preconditioning drive, the fuel tank of the vehicle shall be emptied. This shall be done so as not to abnormally purge or abnormally load the evaporative control devices fitted to the vehicle. Removal of the fuel cap is normally sufficient to achieve this. The fuel tank shall be refilled with test fuel at a temperature of $18\text{ °C} \pm 2\text{ °C}$ to 40 ± 2 per cent of its nominal capacity.

6.5.5. Soak

Within five minutes of completing fuel drain and refill, the vehicle shall be parked for a minimum of 12 hours and a maximum of 36 hours at $23\text{ °C} \pm 3\text{ °C}$.

During soaking, the procedures described in paragraphs 6.5.5.1. and 6.5.5.2. of this annex may be performed either in the order of first paragraph 6.5.5.1. followed by paragraph 6.5.5.2. or in the order paragraph 6.5.5.2. followed by paragraph 6.5.5.1. The procedures described in paragraphs 6.5.5.1. and 6.5.5.2. may also be performed simultaneously.

6.5.5.1. REESS charge

For OVC-HEVs, the REESS shall be fully charged according to the charging requirements described in paragraph 2.2.3. of Appendix 4 to Annex B8.

6.5.5.2. Carbon canister loading

The carbon canister aged according to the sequence described in paragraph 5.1. to 5.1.3.1.3. inclusive of this annex shall be loaded to 2 gram breakthrough according to the procedure described in paragraph 6.5.5.2.1. of this annex.

One of the methods specified in paragraphs 6.5.5.3. and 6.5.5.4. of this annex shall be used to precondition the evaporative canister. For vehicles with multiple canisters, each canister shall be preconditioned separately.

6.5.5.2.1. Canister emissions are measured to determine breakthrough.

Breakthrough is here defined as the point at which the cumulative quantity of hydrocarbons emitted is equal to 2 grams.

6.5.5.2.2. Breakthrough may be verified using the evaporative emission enclosure as described in paragraphs 6.5.5.3. and 6.5.5.4. of this annex. Alternatively, breakthrough may be determined using an auxiliary evaporative canister connected downstream of the vehicle's canister. The auxiliary canister shall be well purged with dry air prior to loading.

- 6.5.5.2.3. The measuring chamber shall be purged for several minutes immediately before the test until a stable background is obtained. The chamber air mixing fan(s) shall be switched on at this time.
- The hydrocarbon analyser shall be zeroed and spanned immediately before the test.
- 6.5.5.3. Canister loading with repeated heat builds to breakthrough
- 6.5.5.3.1. The fuel tank(s) of the vehicle(s) is (are) emptied using the fuel tank drain(s). This shall be done so as not to abnormally purge or abnormally load the evaporative control devices fitted to the vehicle. Removal of the fuel cap is normally sufficient to achieve this.
- 6.5.5.3.2. The fuel tank(s) is (are) refilled with test fuel at a temperature of between 10 to 14 °C to 40 ± 2 per cent of the tank's normal volumetric capacity. The fuel cap(s) of the vehicle shall be fitted at this point.
- 6.5.5.3.3. Within one hour of being refuelled the vehicle shall be placed, with the engine shut off, in the evaporative emission enclosure. The fuel tank temperature sensor is connected to the temperature recording system. A heat source shall be properly positioned with respect to the fuel tank(s) and connected to the temperature controller. The heat source is specified in paragraph 4.9. of this annex. In the case of vehicles fitted with more than one fuel tank, all the tanks shall be heated in the same way as described below. The temperatures of the tanks shall be identical to within ±1.5 °C.
- 6.5.5.3.4. The fuel may be artificially heated to the starting diurnal temperature of 20 °C ± 1 °C.
- 6.5.5.3.5. When the fuel temperature reaches at least 19 °C, the following steps shall be taken immediately: the purge blower shall be turned off; enclosure doors closed and sealed; and measurement initiated of the hydrocarbon level in the enclosure.
- 6.5.5.3.6. When the fuel temperature of the fuel tank reaches 20 °C a linear heat build of 15 °C begins. The fuel shall be heated in such a way that the temperature of the fuel during the heating conforms to the function below to within ±1.5 °C. The elapsed time of the heat build and temperature rise is recorded.
- $$T_r = T_o + 0.2333 \times t$$
- Where:
- T_r = required temperature (K),
- T_o = initial temperature (K),
- t = time from start of the tank heat build in minutes.
- 6.5.5.3.7. As soon as break-through occurs or when the fuel temperature reaches 35 °C, whichever occurs first, the heat source is turned off, the enclosure doors unsealed and opened, and the vehicle fuel tank cap(s) removed. If break-through has not occurred by the time the fuel temperature 35 °C, the heat source is removed from the vehicle, the vehicle removed from the evaporative emission enclosure and the entire procedure outlined in paragraph 6.6.1.2. of this annex repeated until break-through occurs.
- 6.5.5.4. Butane loading to breakthrough
- 6.5.5.4.1. If the enclosure is used for the determination of the break-through (see paragraph 6.5.5.2.2. of this annex) the vehicle shall be placed, with the engine shut off, in the evaporative emission enclosure.
- 6.5.5.4.2. The evaporative emission canister shall be prepared for the canister loading operation. The canister shall not be removed from the vehicle, unless access to

it in its normal location is so restricted that loading can only reasonably be accomplished by removing the canister from the vehicle. Special care shall be taken during this step to avoid damage to the components and the integrity of the fuel system.

- 6.5.5.4.3. The canister is loaded with a mixture composed of 50 per cent butane and 50 per cent nitrogen by volume at a rate of 40 grams butane per hour.
- 6.5.5.4.4. As soon as the canister reaches breakthrough, the vapour source shall be shut off.
- 6.5.5.4.5. The evaporative emission canister shall then be reconnected and the vehicle restored to its normal operating condition.
- 6.5.6. Dynamometer test
- The test vehicle shall be pushed onto a dynamometer and shall be driven over the cycles described in paragraph 6.5.3.(a) or paragraph 6.5.3.(b) of this annex. OVC-HEVs shall be operated in charge-depleting operating condition. The engine shall be subsequently shut off. Exhaust emissions may be sampled during this operation and the results may be used for the purpose of exhaust emission and fuel consumption type approval if this operation meets the requirement described in Annex B6 or Annex B8.
- 6.5.7. Hot soak evaporative emissions test
- Within 7 minutes after the dynamometer test and within 2 minutes of the engine being switched off, the hot soak evaporative emissions test shall be performed in accordance with paragraphs 6.5.7.1. to 6.5.7.8. of this annex. The hot soak losses shall be calculated according to paragraph 7.1. of this annex and recorded as M_{HS} .
- 6.5.7.1. Before the completion of the test run the measuring chamber shall be purged for several minutes until a stable hydrocarbon background is obtained. The enclosure mixing fan(s) shall also be turned on at this time.
- 6.5.7.2. The hydrocarbon analyser shall be zeroed and spanned immediately prior to the test.
- 6.5.7.3. At the end of the driving cycle the engine bonnet shall be completely closed and all connections between the vehicle and the test stand disconnected. The vehicle is then driven to the measuring chamber with a minimum use of the accelerator pedal. The engine shall be turned off before any part of the vehicle enters the measuring chamber. The time at which the engine is switched off is recorded on the evaporative emission measurement data recording system and temperature recording begins. The vehicle's windows and luggage compartments shall be opened at this stage, if not already opened.
- 6.5.7.4. The vehicle shall be pushed or otherwise moved into the measuring chamber with the engine switched off.
- 6.5.7.5. The enclosure doors are closed and sealed gas-tight within two minutes of the engine being switched off and within seven minutes of the end of the conditioning drive.
- 6.5.7.6. The start of a 60 ± 0.5 minute hot soak period begins when the chamber is sealed. The hydrocarbon concentration, temperature and barometric pressure are measured to give the initial readings C_{HCi} , P_i and T_i for the hot soak test. These figures are used in the evaporative emission calculation, paragraph 6. The ambient temperature T of the enclosure shall not be less than $23\text{ }^{\circ}\text{C}$ and no more than $31\text{ }^{\circ}\text{C}$ during the 60-minute hot soak period.
- 6.5.7.7. The hydrocarbon analyser shall be zeroed and spanned immediately before the end of the 60 ± 0.5 minute test period.

- 6.5.7.8. At the end of the 60 ± 0.5 minute test period, the hydrocarbon concentration in the chamber shall be measured. The temperature and the barometric pressure are also measured. These are the final readings C_{HCF} , P_f and T_f for the hot soak test used for the calculation in paragraph 6. of this annex.
- 6.5.8. Soak
- After the hot soak evaporative emissions test, the test vehicle shall be soaked for not less than 6 hours and not more than 36 hours between the end of the hot soak test and the start of the diurnal emission test. For at least the last 6 hours of this period the vehicle shall be soaked at $20 \text{ }^\circ\text{C} \pm 2 \text{ }^\circ\text{C}$.
- 6.5.9. Diurnal testing
- 6.5.9.1. The test vehicle shall be exposed to two cycles of ambient temperature in accordance with the profile specified in Table C4/1 with a maximum deviation of $\pm 2 \text{ }^\circ\text{C}$ at any time. The average temperature deviation from the profile, calculated using the absolute value of each measured deviation, shall not exceed $\pm 1 \text{ }^\circ\text{C}$. Ambient temperature shall be measured and recorded at least every minute. Temperature cycling shall begin at time $T_{\text{start}} = 0$, as specified in paragraph 6.5.9.6. of this annex.

Table C4/1

Diurnal ambient temperature profiles

<i>Diurnal ambient temperature profile for the calibration of the enclosure and the diurnal emission test</i>			<i>Alternative diurnal ambient temperature profile for the calibration of the enclosure</i>	
<i>Time (hours)</i>		<i>Temperature ($^\circ\text{C}$)</i>	<i>Time (hours)</i>	<i>Temperature ($^\circ\text{C}$)</i>
<i>Calibration</i>	<i>Test</i>			
13	0/24	20.0	0	35.6
14	1	20.2	1	35.3
15	2	20.5	2	34.5
16	3	21.2	3	33.2
17	4	23.1	4	31.4
18	5	25.1	5	29.7
19	6	27.2	6	28.2
20	7	29.8	7	27.2
21	8	31.8	8	26.1
22	9	33.3	9	25.1
23	10	34.4	10	24.3
24/0	11	35.0	11	23.7
1	12	34.7	12	23.3
2	13	33.8	13	22.9
3	14	32.0	14	22.6
4	15	30.0	15	22.2
5	16	28.4	16	22.5
6	17	26.9	17	24.2
7	18	25.2	18	26.8
8	19	24.0	19	29.6
9	20	23.0	20	31.9
10	21	22.0	21	33.9
11	22	20.8	22	35.1

12	23	20.2	23	3.4
			24	35.6

- 6.5.9.2. The enclosure shall be purged for several minutes immediately before the test until a stable background is obtained. The chamber mixing fan(s) shall also be switched on at this time.
- 6.5.9.3. The test vehicle, with the powertrain shut off and the test vehicle windows and luggage compartment(s) opened, shall be moved into the measuring chamber. The mixing fan(s) shall be adjusted in such a way as to maintain a minimum air circulation speed of 8 km/h under the fuel tank of the test vehicle.
- 6.5.9.4. The hydrocarbon analyser shall be zeroed and spanned immediately before the test.
- 6.5.9.5. The enclosure doors shall be closed and sealed gas-tight.
- 6.5.9.6. Within 10 minutes of closing and sealing the doors, the hydrocarbon concentration, temperature and barometric pressure shall be measured to give initial readings of hydrocarbon concentration in the enclosure (C_{HCi}), barometric pressure (P_i) and ambient chamber temperature (T_i) for the diurnal testing. $T_{start} = 0$ starts at this time.
- 6.5.9.7. The hydrocarbon analyser shall be zeroed and spanned immediately before the end of each emission sampling period.
- 6.5.9.8. The end of the first and second emission sampling period shall occur at 24 hours ± 6 minutes and 48 hours ± 6 minutes, respectively, after the beginning of the initial sampling, as specified in paragraph 6.5.9.6. of this annex. The elapsed time shall be recorded.
- At the end of each emission sampling period, the hydrocarbon concentration, temperature and barometric pressure shall be measured and used to calculate the diurnal test results using the equation in paragraph 7.1. of this annex. The result obtained from the first 24 hours shall be recorded as M_{D1} . The result obtained from the second 24 hours shall be recorded as M_{D2} .
- 6.6. Continuous test procedure for sealed fuel tank systems
- 6.6.1. In the case that the fuel tank relief pressure is greater than or equal to 30 kPa
- 6.6.1.1. The test shall be performed as described in paragraphs 6.5.1. to 6.5.3. inclusive of this annex.
- 6.6.1.2. Fuel drain and refill
- Within one hour after the preconditioning drive, the fuel tank of the vehicle shall be emptied. This shall be done so as not to abnormally purge or abnormally load the evaporative control devices fitted to the vehicle. Removal of the fuel cap is normally sufficient to achieve this, otherwise the carbon canister shall be disconnected. The fuel tank shall be refilled with reference fuel at a temperature of $18\text{ }^{\circ}\text{C} \pm 2\text{ }^{\circ}\text{C}$ to 15 ± 2 per cent of the tank's nominal capacity. The operations described in paragraphs 6.6.1.3., 6.6.1.4. and 6.6.1.5. of this annex shall be completed within a total of 36 hours and for the operations described in paragraphs 6.6.1.4. and 6.6.1.5. the vehicle shall not be exposed to temperatures above 25°C .
- 6.6.1.3. Soak
- Within 5 minutes after completing fuel drain and refill, the vehicle shall be soaked for stabilisation for at least 6 hours at an ambient temperature of $20\text{ }^{\circ}\text{C} \pm 2\text{ }^{\circ}\text{C}$.

6.6.1.4. Fuel tank depressurisation

The tank pressure shall be subsequently released so as not to abnormally raise the inside pressure of the fuel tank. This may be done by opening the fuel cap of the vehicle. Regardless of the method of depressurisation, the vehicle shall be returned to its original condition within 1 minute.

6.6.1.5. Carbon canister loading and purge

The carbon canister aged in accordance with the sequence described in paragraph 5.1. to 5.1.3.1.3. inclusive of this annex shall be loaded to 2 gram breakthrough according to the procedure described in paragraphs 6.5.5.4. to 6.5.5.4.5. inclusive to this annex, and shall be subsequently purged with 25 ± 5 litres per minute with emission laboratory air. The volume of purge air shall not exceed the volume determined in accordance with the requirements of paragraph 6.6.1.5.1. This loading and purging can be done either (a) using an on-board carbon canister at a temperature of 20 °C or optionally 23 °C, or (b) by disconnecting the carbon canister. In both cases, no further relief of the tank pressure is allowed.

6.6.1.5.1. Determination of maximum purge volume

The maximum purge amount Vol_{max} shall be determined by the following equation. In the case of OVC-HEVs, the vehicle shall be operated in charge-sustaining operating condition. This determination can also be done at a separate test or during the preconditioning drive.

$$Vol_{max} = Vol_{Pcycle} \times \frac{Vol_{tank} \times 0.85 \times \frac{100}{FC_{Pcycle}}}{Dist_{Pcycle}}$$

where:

Vol_{Pcycle} is the cumulative purge volume rounded to the nearest 0.1 litres measured using a suitable device (e.g. flowmeter connected to the vent of the carbon canister or equivalent) over the cold start preconditioning drive described in the paragraph 6.5.3. of this annex, l;

Vol_{tank} is the manufacturer's nominal fuel tank capacity, l;

FC_{Pcycle} is the fuel consumption over the single purge cycle described in paragraph 6.5.3. of this annex which may be measured in either warm or cold start condition, l/100 km. For OVC-HEVs and NOVC-HEVs, fuel consumption shall be calculated according to paragraph 4.2.1. of Annex B8 of this Regulation;

$Dist_{Pcycle}$ is the theoretical distance to the nearest 0.1 km of a single purge cycle described in paragraph 6.5.3. of this annex, km.

6.6.1.6. Preparation of carbon canister depressurisation puff loss loading

After completing carbon canister loading and purging, the test vehicle shall be moved into an enclosure, either a SHED or an appropriate climatic chamber. It shall be demonstrated that the system is leak-free and the pressurisation is performed in a normal way during the test or by a separate test (e.g. by means of pressure sensor on the vehicle). The test vehicle shall be subsequently exposed to the first 11 hours of the ambient temperature profile specified for the diurnal emission test in Table C4/1 with a maximum deviation of ± 2 °C at any time. The average temperature deviation from the profile, calculated using the absolute value of each measured deviation, shall not exceed ± 1 °C. The ambient temperature shall be measured and recorded at least every 10 minutes.

- 6.6.1.7. Carbon canister puff loss loading
- 6.6.1.7.1. Fuel tank depressurisation before refuelling
- The manufacturer shall ensure that the refuelling operation cannot be initiated before the sealed fuel tank system is fully depressurised to a pressure less than 2.5 kPa above ambient pressure in normal vehicle operation and use. At the request of the responsible authority, the manufacturer shall provide detailed information or demonstrate proof of operation (e.g. by means of pressure sensor on the vehicle). Any other technical solution may be allowed provided that a safe refuelling operation is ensured and that no excessive emissions are released to the atmosphere before the refuelling device is connected to the vehicle.
- 6.6.1.7.2. Within 15 minutes after the ambient temperature has reached 35 °C, the tank relief valve shall be opened to load the carbon canister. This loading procedure may be performed either inside or outside an enclosure. The carbon canister loaded according to this paragraph shall be disconnected and shall be kept in the soak area.
- 6.6.1.8. Measurement of depressurisation puff loss overflow
- The depressurisation puff loss overflow shall be measured using the process in either paragraph 6.6.1.8.1. or 6.6.1.8.2. of this annex.
- 6.6.1.8.1. The depressurisation puff loss overflow from the vehicle carbon canister may be measured by using an additional carbon canister identical to the vehicle's carbon canister but not necessarily aged. The additional carbon canister shall be fully purged with dry air prior to loading and shall be connected directly at the outlet of the vehicle's canister with the shortest possible tube. The additional carbon canister shall be weighed before and after the procedure described in paragraph 6.6.1.7. of this annex.
- 6.6.1.8.2. The depressurisation puff loss overflow from the vehicle carbon canister during its depressurisation may be measured using a SHED.
- Within 15 minutes after the ambient temperature has reached 35°C as described in paragraph 6.6.1.6. of this annex, the chamber shall be sealed and the measurement procedure shall be started.
- The hydrocarbon analyser shall be zeroed and spanned, after which the hydrocarbon concentration (C_{HCl}), temperature (T_i) and barometric pressure (P_i) shall be measured to give the initial readings C_{HCl} , P_i and T_i for the sealed tank depressurisation puff loss overflow determination.
- The ambient temperature T of the enclosure shall not be less than 25°C during the measurement procedure.
- At the end of the procedure described in paragraph 6.6.1.7.2. of this annex, the hydrocarbon concentration (C_{HCl}) in the chamber shall be measured after 300 ± 5 seconds. The temperature (T_f) and the barometric pressure (P_f) shall also be measured. These are the final readings C_{HCl} , P_f and T_f for the sealed tank depressurisation puff loss overflow.
- The sealed tank puff loss overflow result shall be calculated according to paragraph 7.1. of this annex and recorded.
- 6.6.1.8.3. There shall be no change in weight of the additional carbon canister when testing according to paragraph 6.6.1.8.1. or the result of the SHED measurement when testing according to paragraph 6.6.1.8.2., within the tolerance of ± 0.5 gram.
- 6.6.1.9. Soak
- After completing puff loss loading the vehicle carbon canister shall be replaced with a dummy carbon canister (of the same specification as the original but not

necessarily aged), the vehicle shall then be soaked at 23 ± 2 °C for 6 to 36 hours to stabilise the vehicle temperature.

6.6.1.9.1. REESS charge

For OVC-HEVs, the REESS shall be fully charged in accordance with the charging requirements described in paragraph 2.2.3. of Appendix 4 to Annex B8 during the soaking described in paragraph 6.6.1.9. of this annex.

6.6.1.10. Fuel drain and refill

The fuel tank of the vehicle shall be drained and filled up to 40 ± 2 per cent of the tank's nominal capacity with reference fuel at a temperature of $18 \text{ °C} \pm 2 \text{ °C}$.

6.6.1.11. Soak

The vehicle shall be subsequently parked for a minimum of 6 hours to a maximum of 36 hours in the soak area at $20 \text{ °C} \pm 2 \text{ °C}$ to stabilise the fuel temperature.

6.6.1.12. Fuel tank depressurisation

The tank pressure shall be subsequently released so as not to abnormally raise the inside pressure of the fuel tank. This may be done by opening the fuel cap of the vehicle. Regardless of the method of depressurisation, the vehicle shall be returned to its original condition within 1 minute. After this action, the vehicle carbon canister shall be connected again.

6.6.1.13. The procedures in paragraphs 6.5.6. to 6.5.9.8. inclusive of this annex shall be followed.

6.6.2. In the case that the fuel tank relief pressure is lower than 30 kPa

The test shall be performed as described in paragraphs 6.6.1.1. to 6.6.1.13. inclusive of this annex. However, in this case, the ambient temperature described in paragraph 6.5.9.1. of this annex shall be replaced by the profile specified in Table C4/2 of this annex for the diurnal emission test.

Table C4/2

Ambient temperature profile of the alternative sequence for sealed fuel tank system

<i>Time (hours)</i>	<i>Temperature (°C)</i>
0/24	20.0
1	20.4
2	20.8
3	21.7
4	23.9
5	26.1
6	28.5
7	31.4
8	33.8
9	35.6
10	37.1
11	38.0
12	37.7
13	36.4
14	34.2
15	31.9
16	29.9

<i>Time (hours)</i>	<i>Temperature (°C)</i>
17	28.2
18	26.2
19	24.7
20	23.5
21	22.3
22	21.0
23	20.2

- 6.7. Stand-alone test procedure for sealed fuel tank systems
- 6.7.1 Measurement of depressurisation puff loss loading mass
- 6.7.1.1. The procedures in paragraphs 6.6.1.1. to 6.6.1.7.2. inclusive of this annex shall be performed. The depressurisation puff loss loading mass is defined as the difference in weight of the vehicle carbon canister before paragraph 6.6.1.6. of this annex is applied and after paragraph 6.6.1.7.2. of this annex is applied.
- 6.7.1.2. The depressurisation puff loss overflow from the vehicle carbon canister shall be measured according to paragraphs 6.6.1.8.1. and 6.6.1.8.2. inclusive of this Annex and fulfil the requirements of paragraph 6.6.1.8.3. in this annex.
- 6.7.2. Hot soak and diurnal breathing evaporative emissions test
- 6.7.2.1. In the case that the fuel tank relief pressure is greater than or equal to 30 kPa
- 6.7.2.1.1. The test shall be performed as described in paragraphs 6.5.1. to 6.5.3. and 6.6.1.9. to 6.6.1.9.1. inclusive of this annex.
- 6.7.2.1.2. The carbon canister shall be aged according to the sequence described in paragraph 5.1. to 5.1.3.1.3. inclusive of this annex and shall be loaded and purged according to paragraph 6.6.1.5. of this annex.
- 6.7.2.1.3. The aged carbon canister shall subsequently be loaded according to the procedure described in paragraph 6.5.5.4. However, instead of loading to breakthrough as described in paragraph 6.5.5.4.4., the total loading mass shall be determined in accordance with paragraph 6.7.1.1. of this annex. At the request of the manufacturer, the reference fuel may alternatively be used instead of butane. The carbon canister shall be disconnected.
- 6.7.2.1.4. The procedures in paragraphs 6.6.1.10. to 6.6.1.13. inclusive of this annex shall be followed.
- 6.7.2.2. In the case that the fuel tank relief pressure is lower than 30 kPa
- The test shall be performed as described in paragraphs 6.7.2.1.1. to 6.7.2.1.4. inclusive of this annex. However, in this case, the ambient temperature described in paragraph 6.5.9.1. of this annex shall be modified in accordance with the profile specified in Table A1/1 of this annex for the diurnal emission test.
7. Calculation of evaporative test results
- 7.1. The evaporative emission tests described in paragraphs 6. to 6.7.2.2. inclusive of this annex allow the hydrocarbon emissions from the puff loss overflow, diurnal and hot soak tests to be calculated. Evaporative losses from each of these tests shall be calculated using the initial and final hydrocarbon concentrations, temperatures and pressures in the enclosure, together with the net enclosure volume.

The following equation shall be used:

$$M_{HC} = k \times V \times \left(\frac{C_{HCf} \times P_f}{T_f} - \frac{C_{HCi} \times P_i}{T_i} \right) + M_{HC,out} - M_{HC,in}$$

where:

M_{HC} is the mass of hydrocarbons, grams;

$M_{HC,out}$ is the mass of hydrocarbons exiting the enclosure in the case of fixed volume enclosures for diurnal emission testing, grams;

$M_{HC,in}$ is the mass of hydrocarbon entering the enclosure in the case of fixed volume enclosures for diurnal emission testing, grams;

C_{HC} is the measured hydrocarbon concentration in the enclosure, ppm volume in C_1 equivalent;

V is the net enclosure volume corrected for the volume of the vehicle with the windows and the luggage compartment open, m^3 . If the volume of the vehicle is not known, a volume of $1.42 m^3$ shall be subtracted;

T is the ambient chamber temperature, K;

P is the barometric pressure, kPa;

H/C is the hydrogen to carbon ratio

where:

H/C is taken to be 2.33 for puff loss overflow measurement in SHED and diurnal test losses;

H/C is taken to be 2.20 for hot soak losses;

H/C is taken to be 2.67 for calibration;

k is $1.2 \times 10^{-4} \times (12 + H/C)$, in $(g \times K/(m^3 \times kPa))$;

i is the initial reading;

f is the final reading;

7.1.1. As an alternative to the equation in paragraph 7.1. of this annex, for variable volume enclosures the following equation may be used at the choice of the manufacturer:

$$M_{HC} = k \times V \times \frac{P_i}{T_i} (C_{HCf} - C_{HCi})$$

where:

M_{HC} is the mass of hydrocarbons, grams;

C_{HC} is the measured hydrocarbon concentration in the enclosure, ppm volume in C_1 equivalent;

V is the net enclosure volume corrected for the volume of the vehicle with the windows and the luggage compartment open, m^3 . If the volume of the vehicle is not known, a volume of $1.42 m^3$ shall be subtracted;

T_i is the initial ambient chamber temperature, K;

P_i is the initial barometric pressure, kPa;

H/C is the hydrogen to carbon ratio;

H/C is taken to be 2.33 for puff loss overflow measurement in SHED and diurnal test losses;

H/C is taken to be 2.20 for hot soak losses;

H/C is taken to be 2.67 for calibration;

k is $1.2 \times 10^{-4} \times (12 + H/C)$, in $(g \times K/(m^3 \times kPa))$

i is the initial reading;

f is the final reading.

- 7.2. The result of $(M_{HS} + M_{D1} + M_{D2} + (2 \times PF))$ shall be below the limit defined in paragraph 6.6.2. of this Regulation.
8. Test report
- The test report shall contain at least the following:
- (a) Description of the soak periods, including time and mean temperatures;
 - (b) Description of aged carbon canister used and reference to exact ageing report;
 - (c) Mean temperature during the hot soak test;
 - (d) Measurement during hot soak test, HSL;
 - (e) Measurement of first diurnal, DL1st day;
 - (f) Measurement of second diurnal, DL2nd day;
 - (g) Final evaporative test result, calculated according to paragraph 7. of this annex;
 - (h) Declared fuel tank relief pressure of the system (for sealed tank systems);
 - (i) Puff loss loading value (in the case of using 'stand-alone test procedure' described in paragraph 6.7. of this annex).

Annex C4

Type 5 test

(Description of the endurance test for verifying the durability of pollution control devices)

1. Introduction
 - 1.1. This annex describes the test for verifying the durability of anti-pollution devices equipping vehicles with positive ignition or compression-ignition engines.

The durability requirements shall be demonstrated using one of the two options set out in paragraphs 1.2. and 1.4. below.
 - 1.2. The whole vehicle durability test shall preferably be performed on a vehicle with the cycle energy demand of the VH (as defined in paragraph 4.2.1.1.2. of Annex B4) with the highest cycle energy demand of all of the Interpolation Families to be included in the durability family and shall be driven on a test track, on the road, or on a chassis dynamometer. The cycle energy of the test vehicle may be further increased to cover future extensions.
 - 1.3. Reserved
 - 1.4. As an alternative to durability testing, where applicable a manufacturer may choose to apply the assigned deterioration factors from Table 3A and Table 3B (as applicable) in paragraph 6.7.2. of this Regulation.
 - 1.5. Reserved
 - 1.6. Deterioration factors are determined using either the procedures set out in paragraph 1.2. or using the assigned values in the table referred to in paragraph 1.4. of this annex. The deterioration factors are used to establish compliance with the requirements of the appropriate emissions limits set out in paragraph 6.3.10. of this Regulation during the target useful life of the vehicle.
2. Technical requirements
 - 2.1. As the operating cycle for the whole vehicle durability test, the vehicle manufacturer shall use the Standard Road Cycle (SRC) described in Appendix 3 to this annex. This test cycle shall be conducted until the vehicle has covered its target useful life.
3. Test vehicle
 - 3.1. The vehicle shall be VH. It shall be in good mechanical order; the engine and the anti-pollution devices shall be new. The vehicle may be the same as that presented for the Type 1 test; in this case the Type 1 test has to be done after the vehicle has run at least 3,000 km of the ageing cycle of Appendix 3. to this annex.
 - 3.1.1. Special requirements for hybrid vehicles are provided in Appendix 4 to this annex.
4. Fuel

The durability test is conducted with a suitable commercially available fuel.
5. Vehicle maintenance and adjustments

Maintenance, adjustments as well as the use of the test vehicle's controls shall be those recommended by the manufacturer. If during the execution of the whole vehicle durability test the vehicle experiences a failure not related to emissions and/or fuel consumption and/or energy consumption, the manufacturer can fix the vehicle and continue with the durability test.

Otherwise the manufacturer shall consult the approval authority to find a commonly agreed solution.

6. Vehicle operation on track, road or on chassis dynamometer
 - 6.1. Operating cycle

During operation on track, road or on roller test bench, the distance shall be covered according to the driving schedule described in Appendix 3 of this annex.
 - 6.2. The durability test, or if the manufacturer has chosen, the modified durability test shall be conducted until the vehicle has covered its target useful life.
 - 6.3. Test equipment
 - 6.3.1. Chassis dynamometer
 - 6.3.1.1. When the durability test is performed on a chassis dynamometer, the dynamometer shall enable the cycle described in Appendix 3 of this annex to be carried out. In particular, it shall be equipped with systems simulating inertia and resistance to progress.
 - 6.3.1.2. The road load coefficients to be used shall be those for vehicle high (VH).
 - 6.3.1.3. The vehicle cooling system should enable the vehicle to operate at temperatures similar to those obtained on road (oil, water, exhaust system, etc.).
 - 6.3.1.4. Certain other test bench adjustments and features are deemed to be identical, where necessary, to those described in Annex B5 to this Regulation (inertia, for example, which may be mechanical or electronic).
 - 6.3.1.5. The vehicle may be moved, where necessary, to a different bench in order to conduct emission measurement tests.
 - 6.3.2. Operation on track or road

When the durability test is completed on track or road, the test mass of the vehicle shall be the same as that retained for tests conducted on a chassis dynamometer.
7. Measuring emissions of pollutants

A first test is carried out when the vehicle has reached a mileage between 3,000 km and 5,000 km. Further tests are carried out at 20,000 km (± 400 km) and then every 20,000 km (± 400 km) or more frequently, at regular intervals until having covered the target useful life. Exhaust emissions are measured in accordance with the Type 1 Test as defined in paragraph 6.3. of this Regulation. At the choice of the manufacturer any of the above tests can be repeated. In such a case the average value of all the repeated tests shall be considered as a single value for the relevant mileage. After 80,000 km has been driven, it is no longer necessary to separately record the emissions results from the first 3 phases of WLTP.

The limit values to be complied with are those laid down in paragraph 6.3.10. of this Regulation.

In the case of vehicles equipped with periodically regenerating systems as defined in paragraph 3.8.1. of this Regulation, it shall be checked that the vehicle is not approaching a regeneration period. If this is the case, the vehicle shall be driven until the end of the regeneration. If a regeneration occurs during the emissions measurement, a new test (including preconditioning) shall be performed, and the first result not taken into account.

All exhaust emissions results shall be plotted as a function of the running distance on the system rounded to the nearest kilometre and the best fit straight

line fitted by the method of least squares shall be drawn through all these data points.

For the criteria emissions from the 4 phases of a WLTP test The data will be acceptable for use in the calculation of the deterioration factor only if the interpolated 5,000 km and target useful life points on this line are within the above mentioned limits.

The data are still acceptable when a best fit straight line crosses an applicable limit with a negative slope (the 5,000 km interpolated point is higher than the target useful life point) but the target useful life actual data point is below the limit.

For criteria emissions from the first 3 phases of a WLTP test

The data will be acceptable for use in the calculation of the deterioration factor only if the extrapolated 3,000 km and the target useful life points on this line are within the above mentioned limits.

- 7.1. A multiplicative exhaust emission deterioration factor shall be calculated for each pollutant as follows:

$$D. E. F. = \frac{Mi_2}{Mi_1}$$

Where:

$Mi_1 =$

For the criteria emissions from the 4 phases of a WLTP test - mass emission of the pollutant i in g/km interpolated to 5,000 km,

For criteria emissions from the first 3 phases of a WLTP test - mass emission of the pollutant i in g/km extrapolated to 3,000 km

$Mi_2 =$ mass emission of the pollutant i in g/km interpolated to the respective target useful life

These interpolated values shall be carried out to a minimum of four places to the right of the decimal point before dividing one by the other to determine the deterioration factor. The result shall be rounded to three places to the right of the decimal point.

If a deterioration factor is less than one, it is deemed to be equal to one.

At the request of a manufacturer, an additive exhaust emission deterioration factor shall be calculated for each pollutant as follows:

$$D . E . F . = Mi_2 - Mi_1$$

If the additive deterioration factor calculated with the above formula is negative, then it shall be put equal to zero.

These additive deterioration factors shall follow the same rules described for the multiplicative deterioration factors in relation to the criteria emissions from the 4 phases of a WLTP test and for criteria emissions from the first 3 phases of a WLTP test.

Annex C4 - Appendix 1

Reserved

Annex C4 - Appendix 2

Reserved

Annex C4 - Appendix 3

Standard Road Cycle (SRC)

1. Introduction

The Standard Road Cycle (SRC) is a kilometre accumulation cycle on VH. The vehicle may be run on a test track or on a kilometre accumulation dynamometer.

The cycle consists of 7 laps of a 6 km course. The length of the lap may be changed to accommodate the length of the mileage accumulation test track.

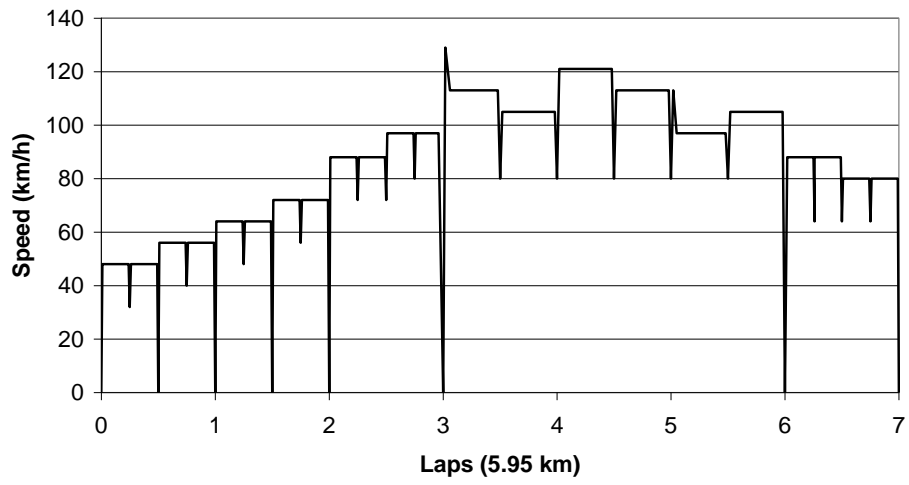
Standard road cycle

<i>Lap</i>	<i>Description</i>	<i>Typical acceleration rate m/s²</i>
1	(start engine) idle 10 seconds	0
1	Moderate acceleration to 48 km/h	1.79
1	Cruise at 48 km/h for ¼ lap	0
1	Moderate deceleration to 32 km/h	-2.23
1	Moderate acceleration to 48 km/h	1.79
1	Cruise at 48 km/h for ¼ lap	0
1	Moderate deceleration to stop	-2.23
1	Idle 5 seconds	0
1	Moderate acceleration to 56 km/h	1.79
1	Cruise at 56 km/h for ¼ lap	0
1	Moderate deceleration to 40 km/h	-2.23
1	Moderate acceleration to 56 km/h	1.79
1	Cruise at 56 km/h for ¼ lap	0
1	Moderate deceleration to stop	-2.23
2	Idle 10 seconds	0
2	Moderate acceleration to 64 km/h	1.34
2	Cruise at 64 km/h for ¼ lap	0
2	Moderate deceleration to 48 km/h	-2.23
2	Moderate acceleration to 64 km/h	1.34
2	Cruise at 64 km/h for ¼ lap	0
2	Moderate deceleration to stop	-2.23
2	Idle 5 seconds	0
2	Moderate acceleration to 72 km/h	1.34
2	Cruise at 72 km/h for ¼ lap	0
2	Moderate deceleration to 56 km/h	-2.23
2	Moderate acceleration to 72 km/h	1.34
2	Cruise at 72 km/h for ¼ lap	0
2	Moderate deceleration to stop	-2.23
3	Idle 10 seconds	0
3	Hard acceleration to 88 km/h	1.79
3	Cruise at 88 km/h for ¼ lap	0
3	Moderate deceleration to 72 km/h	-2.23
3	Moderate acceleration to 88 km/h	0.89
3	Cruise at 88 km/h for ¼ lap	0
3	Moderate deceleration to 72 km/h	-2.23
3	Moderate acceleration to 97 km/h	0.89
3	Cruise at 97 km/h for ¼ lap	0

<i>Lap</i>	<i>Description</i>	<i>Typical acceleration rate m/s²</i>
3	Moderate deceleration to 80 km/h	-2.23
3	Moderate acceleration to 97 km/h	0.89
3	Cruise at 97 km/h for ¼ lap	0
3	Moderate deceleration to stop	-1.79
4	Idle 10 seconds	0
4	Hard acceleration to 129 km/h	1.34
4	Coast down to 113 km/h	-0.45
4	Cruise at 113 km/h for ½ lap	0
4	Moderate deceleration to 80 km/h	-1.34
4	Moderate acceleration to 105 km/h	0.89
4	Cruise at 105 km/h for ½ lap	0
4	Moderate deceleration to 80 km/h	-1.34
5	Moderate acceleration to 121 km/h	0.45
5	Cruise at 121 km/h for ½ lap	0
5	Moderate deceleration to 80 km/h	-1.34
5	Light acceleration to 113 km/h	0.45
5	Cruise at 113 km/h for ½ lap	0
5	Moderate deceleration to 80 km/h	-1.34
6	Moderate acceleration to 113 km/h	0.89
6	Coast down to 97 km/h	-0.45
6	Cruise at 97 km/h for ½ lap	0
6	Moderate deceleration to 80 km/h	-1.79
6	Moderate acceleration to 104 km/h	0.45
6	Cruise at 104 km/h for ½ lap	0
6	Moderate deceleration to stop	-1.79
7	Idle 45 seconds	0
7	Hard acceleration to 88 km/h	1.79
7	Cruise at 88 km/h for ¼ lap	0
7	Moderate deceleration to 64 km/h	-2.23
7	Moderate acceleration to 88 km/h	0.89
7	Cruise at 88 km/h for ¼ lap	0
7	Moderate deceleration to 64 km/h	-2.23
7	Moderate acceleration to 80 km/h	0.89
7	Cruise at 80 km/h for ¼ lap	0
7	Moderate deceleration to 64 km/h	-2.23
7	Moderate acceleration to 80 km/h	0.89
7	Cruise at 80 km/h for ¼ lap	0
7	Moderate deceleration to stop	-2.23

The standard road cycle is represented graphically in the following figure:

Standard Road Cycle



Annex C4 - Appendix 4

Special requirements for Hybrid Vehicles

1. Introduction
- 1.1. This appendix provides special requirements for the Type 5 test of OVC-HEVs and NOVC-HEVs, as set out in paragraphs 2. and 3. of this appendix.
2. For OVC-HEVs:

It is not allowed to charge the electrical energy/power storage device during mileage accumulation.

For OVC-HEVs with an operating mode switch, mileage accumulation should be driven in the mode which is automatically set after initiation of the vehicle start procedure (normal mode).

During the mileage accumulation a change into another hybrid mode is allowed if necessary in order to continue the mileage accumulation after agreement of the Technical Service.

The measurements of emissions of pollutants shall be carried out under the same conditions as specified in paragraph 3.2.5. of Annex B8.
3. For NOVC-HEVs:

Mileage accumulation shall be driven in the driver selectable mode which is always selected when the vehicle is switched on (predominant mode) or in the mode which is recommended by the manufacturer (if no predominant mode is available) after agreement of the Technical Service.

The measurements of emissions of pollutants shall be carried out in the same conditions as in the Type 1 test.

Annex C5

On-Board Diagnostics (OBD) for motor vehicles

1. Introduction

This annex applies to the functional aspects of On-Board Diagnostic (OBD) system for the emission control of motor vehicles.
2. RESERVED
3. Requirements and tests
 - 3.1. All vehicles shall be equipped with an OBD system so designed, constructed and installed in a vehicle as to enable it to identify types of deterioration or malfunction over the entire life of the vehicle. In achieving this objective, the Type Approval Authority shall accept that vehicles which have travelled distances in excess of the target useful life (according to paragraph 6.7. of this Regulation) referred to in paragraph 3.3.1. of this annex, may show some deterioration in OBD system performance such that the OBD thresholds set out in Table 4A and Table 4B (as applicable) in paragraph 6.8.2. of this Regulation may be exceeded before the OBD system signals a failure to the driver of the vehicle.
 - 3.1.1. Access to the OBD system required for the inspection, diagnosis, servicing or repair of the vehicle shall be unrestricted and standardised. All emission-related fault codes shall be consistent with paragraph 6.5.3.5. of Appendix 1 to this annex.
 - 3.2. The OBD system shall be so designed, constructed and installed in a vehicle as to enable it to comply with the requirements of this annex during conditions of normal use.
 - 3.2.1. Temporary disablement of the OBD system
 - 3.2.1.1. A manufacturer may disable the OBD system if its ability to monitor is affected by low fuel levels. Disablement shall not occur when the fuel tank level is above 20 per cent of the nominal capacity of the fuel tank.
 - 3.2.1.2. A manufacturer may disable the OBD system at ambient engine starting temperatures below 266 K (-7 °C) or at elevations over 2,440 metres above sea level provided the manufacturer submits data and/or an engineering evaluation which adequately demonstrate that monitoring would be unreliable when such conditions exist. A manufacturer may also request disablement of the OBD system at other ambient engine starting temperatures if he demonstrates to the authority with data and/or an engineering evaluation that misdiagnosis would occur under such conditions. It is not necessary to illuminate the Malfunction Indicator (MI) if the OBD thresholds are exceeded during a regeneration provided no defect is present.
 - 3.2.1.3. For vehicles designed to accommodate the installation of power take-off units, disablement of affected monitoring systems is permitted provided disablement occurs only when the power take-off unit is active.

In addition to the provisions of this paragraph the manufacturer may temporarily disable the OBD system in the following conditions:

 - (a) For flex fuel or mono/bi fuel gas vehicles during 1 minute after re-fuelling to allow for the recognition of fuel quality and composition by the ECU;
 - (b) For bi fuel vehicles during 5 seconds after fuel switching to allow for readjusting engine parameters;

- (c) The manufacturer may deviate from these time limits if it can demonstrate that stabilisation of the fuelling system after re-fuelling or fuel switching takes longer for justified technical reasons. In any case, the OBD system shall be re-enabled as soon as either the fuel quality and composition is recognised, or the engine parameters are readjusted.
- 3.2.2. Engine misfire in vehicles equipped with positive ignition engines
- 3.2.2.1. Manufacturers may adopt higher misfire percentage malfunction criteria than those declared to the authority, under specific engine speed and load conditions where it can be demonstrated to the authority that the detection of lower levels of misfire would be unreliable.
- 3.2.2.2. When a manufacturer can demonstrate to the authority that the detection of higher levels of misfire percentages is still not feasible, or that misfire cannot be distinguished from other effects (e.g. rough roads, transmission shifts, after engine starting; etc.) the misfire monitoring system may be disabled when such conditions exist.
- 3.2.3. Identification of deterioration or malfunctions may be also be done outside a driving cycle (e.g. after engine shutdown).
- 3.3. Description of tests
- 3.3.1. The tests are carried out on the vehicle used for the Type 5 durability test, given in Annex C4 to this Regulation, and using the test procedure in Appendix 1 to this annex. Tests are carried out at the conclusion of the Type 5 durability testing.
- When no Type 5 durability testing is carried out, or at the request of the manufacturer, a suitably aged and representative vehicle may be used for these OBD demonstration tests.
- 3.3.2. The OBD system shall indicate the failure of an emission-related component or system when that failure results in emissions exceeding the OBD thresholds set out in Table 4 in paragraph 6.8.2. of this Regulation.
- 3.3.2.1. The OBD thresholds limits for vehicles that are type approved according to the emission limits set out in paragraph 6.3.10. of this Regulation are set out in Table 4A and Table 4B (as applicable) in paragraph 6.8.2. of this Regulation.
- 3.3.3. Monitoring requirements for vehicles equipped with positive ignition engines.
- In satisfying the requirements of paragraph 3.3.2. of this annex the OBD system shall, at a minimum, monitor for:
- 3.3.3.1. The reduction in the efficiency of the catalytic converter with respect to emissions of NMHC and NO_x. Manufacturers may monitor the front catalyst alone or in combination with the next catalyst(s) downstream. Each monitored catalyst or catalyst combination shall be considered malfunctioning when the emissions exceed the NMHC or NO_x OBD thresholds set out in paragraph 6.8.2. of this Regulation.
- 3.3.3.2. The presence of engine misfire in the engine operating region bounded by the following lines:
- (a) A maximum speed of 4,500 min⁻¹ or 1,000 min⁻¹ greater than the highest speed occurring during a Type 1 Test cycle, whichever is the lower;
- (b) The positive torque line (i.e. engine load with the transmission in neutral);
- (c) A line joining the following engine operating points: the positive torque line at 3,000 min⁻¹ and a point on the maximum speed line defined in (a) above with the engine's manifold vacuum at 13.33 kPa lower than that at the positive torque line.

- 3.3.3.2.1. Specific monitoring rate for misfire:
- (a) Catalytic converter protection. The engine misfire which causes the catalytic converter damage because of excessive heat, shall be monitored every 200 revolutions within the region specified in paragraph 3.3.3.2.
- When the evaluated engine misfire rate is less than 5%, the limit can be fixed at 5%.
- (b) Exceeding emission threshold. The engine misfire which causes to exceed an emission threshold shall be monitored every 1,000 revolutions within the region specified in paragraph 3.3.3.2.
- When the evaluated engine misfire rate is less than 1%, the limit can be fixed at 1%.
- 3.3.3.3. Oxygen sensor deterioration
- This paragraph shall mean that the deterioration of all oxygen sensors fitted and used for monitoring malfunctions of the catalytic converter according to the requirements of this annex shall be monitored.
- 3.3.3.4.
- Other emission control system components or systems, or emission related power train components or systems which are connected to a computer, if active on the selected fuel, the failure of which may result in tailpipe emissions exceeding the OBD thresholds set out in Table 4A and Table 4B (as applicable) in paragraph 6.8.2. of this Regulation.
- The following is a non-exhaustive list providing examples of representative components and systems;
- (a) Exhaust gas recirculation system
- (b) Fuel system
- (c) Secondary air system
- (d) Valve timing system
- (e) Atmosphere pressure sensor
- (f) Intake air pressure sensor
- (g) Intake air temperature sensor
- (h) Air flow sensor
- (i) Engine coolant temperature sensor
- (j) Throttle sensor
- (k) Cylinder identification sensor
- (l) Crank angle sensor
- 3.3.3.5. Unless otherwise monitored, any other emission-related power-train component connected to a computer, including any relevant sensors to enable monitoring functions to be carried out, shall be monitored for circuit continuity.
- 3.3.3.6. The electronic evaporative emission purge control shall, at a minimum, be monitored for circuit continuity.
- 3.3.3.7. For direct injection positive ignition engines any malfunction, which may lead to emissions exceeding the particulate OBD thresholds set out in paragraph 6.8.2. of this Regulation and which has to be monitored according to the requirements of this annex for compression ignition engines, shall be monitored.

- 3.3.4. Monitoring requirements for vehicles equipped with compression-ignition engines
- In satisfying the requirements of paragraph 3.3.2. of this annex the OBD system shall monitor:
- 3.3.4.1. Where fitted, reduction in the efficiency of the catalytic converter.
- 3.3.4.2. Where fitted, the functionality and integrity of the particulate trap.
- 3.3.4.3. The fuel-injection system electronic fuel quantity and timing actuator(s) is/are monitored for circuit continuity and total functional failure.
- 3.3.4.4. Other emission control system components or systems, or emission-related power-train components or systems, which are connected to a computer, the failure of which may result in exhaust emissions exceeding the OBD thresholds set out in paragraph 6.8.2. of this Regulation. Examples of such systems or components are those for monitoring and control of air mass-flow, air volumetric flow (and temperature), boost pressure and inlet manifold pressure (and relevant sensors to enable these functions to be carried out).
- 3.3.4.5. Unless otherwise monitored, any other emission-related power-train component connected to a computer shall be monitored for circuit continuity.
- 3.3.4.6. Malfunctions and the reduction in efficiency of the EGR system shall be monitored.
- 3.3.4.7. Malfunctions and the reduction in efficiency of a NO_x after-treatment system using a reagent and the reagent dosing sub-system shall be monitored.
- 3.3.4.8. Malfunctions and the reduction in efficiency of NO_x after-treatment not using a reagent shall be monitored.
- 3.3.5. Manufacturers may demonstrate to the Type Approval Authority that certain components or systems need not be monitored if, in the event of their total failure or removal, emissions do not exceed the OBD thresholds set out in paragraph 6.8.2. of this Regulation.
- 3.3.5.1. The following devices should however be monitored for total failure or removal (if removal would cause the applicable emission limits in paragraph 6.3.10. of this Regulation to be exceeded):
- (a) A particulate trap fitted to compression ignition engines as a separate unit or integrated into a combined emission control device;
 - (b) A NO_x after treatment system fitted to compression ignition engines as a separate unit or integrated into a combined emission control device;
 - (c) A Diesel Oxidation Catalyst (DOC) fitted to compression ignition engines as a separate unit or integrated into a combined emission control device.
- 3.3.5.2. The devices referred to in paragraph 3.3.5.1. of this annex shall also be monitored for any failure that would result in exceeding the applicable OBD thresholds set out in in paragraph 6.8.2. of this Regulation.
- 3.4. A sequence of diagnostic checks shall be initiated at each engine start and completed at least once provided that the correct test conditions are met. The test conditions shall be selected in such a way that they all occur under normal driving as represented by the Type 1 test.
- 3.5. Activation of malfunction indicator (MI)
- 3.5.1. The OBD system shall incorporate a malfunction indicator readily perceivable to the vehicle operator. The MI shall not be used for any other purpose except to indicate emergency start-up, emission default modes or limp-home routines to the driver. The MI shall be visible in all reasonable lighting conditions. When activated, it shall display a symbol in conformity with ISO 2575. A vehicle shall not be equipped with more than one general purpose MI for

emission-related problems. Separate specific purpose tell tales (e. g. brake system, fasten seat belt, oil pressure, etc.) are permitted. The use of red colour for an MI is prohibited.

- 3.5.2. For strategies requiring more than two preconditioning cycles for MI activation, the manufacturer shall provide data and/or an engineering evaluation which adequately demonstrates that the monitoring system is equally effective and timely in detecting component deterioration. Strategies requiring on average more than ten driving cycles for MI activation are not accepted. The MI shall also activate whenever the engine control enters a permanent emission default mode of operation if the OBD thresholds set out in paragraph 6.8.2. of this Regulation are exceeded or if the OBD system is unable to fulfil the basic monitoring requirements specified in paragraph 3.3.3. or 3.3.4. of this annex. The MI shall operate in a distinct warning mode, e.g. a flashing light, under any period during which engine misfire occurs at a level likely to cause catalyst damage, as specified by the manufacturer. The MI shall also activate when the vehicle's ignition is in the "key-on" position before engine starting or cranking and de-activate after engine starting if no malfunction has previously been detected.
- 3.6. Fault code storage
- 3.6.1. The OBD system shall record pending and confirmed fault code(s) indicating the status of the emission control system. Separate status codes (readiness codes) shall be used to identify correctly functioning emission control systems and those emission control systems which need further vehicle operation to be fully evaluated. If the MI is activated due to deterioration or malfunction or permanent emission default modes of operation, a fault code shall be stored that identifies the type of malfunction. A fault code shall also be stored in the cases referred to in paragraphs 3.3.3.5. and 3.3.4.5. of this annex.
- 3.6.2. The distance travelled by the vehicle while the MI is activated shall be available at any instant through the serial port on the standard link connector.
- 3.6.3. In the case of vehicles equipped with positive ignition engines, misfiring cylinders need not be uniquely identified if a distinct single or multiple cylinder misfire fault code is stored.
- 3.7. Extinguishing the MI
- 3.7.1. If misfire at levels likely to cause catalyst damage (as specified by the manufacturer) is not present any more, or if the engine is operated after changes to speed and load conditions where the level of misfire will not cause catalyst damage, the MI may be switched back to the previous state of activation during the first driving cycle on which the misfire level was detected and may be switched to the normal activated mode on subsequent driving cycles. If the MI is switched back to the previous state of activation, the corresponding fault codes and stored freeze-frame conditions may be erased.
- 3.7.2. For all other malfunctions, the MI may be de-activated after three subsequent sequential driving cycles during which the monitoring system responsible for activating the MI ceases to detect the malfunction and if no other malfunction has been identified that would independently activate the MI.
- 3.8. Erasing a fault code
- 3.8.1. The OBD system may erase a fault code and the distance travelled and freeze-frame information if the same fault is not re-registered in at least 40 engine warm-up cycles or 40 driving cycles with vehicle operation in which the following criteria (a)-(c) are satisfied:
- (a) Cumulative time since engine start is greater than or equal to 600 seconds;

- (b) Cumulative vehicle operation at or above 40 km/h occurs for greater than or equal to 300 seconds;
 - (c) Continuous vehicle operation at idle (i.e. accelerator pedal released by driver and vehicle speed less than or equal to 1.6 km/h) for greater than or equal to 30 seconds..
- 3.9. Bi-fuelled gas vehicles
- In general, for bi-fuelled gas vehicles for each of the fuel types (petrol and (NG/biomethane)/LPG) all the OBD requirements as for a mono-fuelled vehicle are applicable. To this end one of the following two options in paragraphs 3.9.1. or 3.9.2. of this annex or any combination thereof, shall be used.
- 3.9.1. One OBD system for both fuel types.
- 3.9.1.1. The following procedures shall be executed for each diagnostic in a single OBD system for operation on petrol and on (NG/biomethane)/LPG, either independent of the fuel currently in use or fuel type specific:
- (a) Activation of malfunction indicator (MI) (see paragraph 3.5. of this annex);
 - (b) Fault code storage (see paragraph 3.6. of this annex);
 - (c) Extinguishing the MI (see paragraph 3.7. of this annex);
 - (d) Erasing a fault code (see paragraph 3.8. of this annex).
- For components or systems to be monitored, either separate diagnostics for each fuel type can be used or a common diagnostic.
- 3.9.1.2. The OBD system can reside in either one or more computers.
- 3.9.2. Two separate OBD systems, one for each fuel type.
- 3.9.2.1. The following procedures shall be executed independently of each other when the vehicle is operated on petrol or on (NG/biomethane)/LPG:
- (a) Activation of malfunction indicator (MI) (see paragraph 3.5. of this annex);
 - (b) Fault code storage (see paragraph 3.6. of this annex);
 - (c) Extinguishing the MI (see paragraph 3.7. of this annex);
 - (d) Erasing a fault code (see paragraph 3.8. of this annex).
- 3.9.2.2. The separate OBD systems can reside in either one or more computers.
- 3.9.3. Specific requirements regarding the transmission of diagnostic signals from bi-fuelled gas vehicles.
- 3.9.3.1. On a request from a diagnostic scan tool, the diagnostic signals shall be transmitted on one or more source addresses. The use of source addresses is described in the standard listed in paragraph 6.5.3.2.(a) of Appendix 1 to this annex.
- 3.9.3.2. Identification of fuel specific information can be realized:
- (a) By use of source addresses; and/or
 - (b) By use of a fuel select switch; and/or
 - (c) By use of fuel specific fault codes.
- 3.9.4. Regarding the status code (as described in paragraph 3.6. of this annex), one of the following two options has to be used, if one or more of the diagnostics reporting readiness is fuel type specific:
- (a) The status code is fuel specific, i.e. use of two status codes, one for each fuel type;

- (b) The status code shall indicate fully evaluated control systems for both fuel types (petrol and (NG/biomethane)/LPG)) when the control systems are fully evaluated for one of the fuel types.

If none of the diagnostics reporting readiness is fuel type specific, then only one status code has to be supported.

- 3.10. Additional provisions for vehicles employing engine shut - off strategies.
 - 3.10.1. Driving cycle
 - 3.10.1.1. Autonomous engine restarts commanded by the engine control system following an engine stall may be considered a new driving cycle or a continuation of the existing driving cycle.
- 4. Requirements relating to the type approval of on-board diagnostic systems
 - 4.1. A manufacturer may request to the Type Approval Authority that an OBD system be accepted for type approval even though the system contains one or more deficiencies such that the specific requirements of this annex are not fully met. The Type Approval Authority may approve up to two separate components or systems with one or more deficiencies.

When a manufacturer adopts specific conditions for misfire defined in paragraph 3.3.3.2.1. of this annex, these conditions shall not be considered as a deficiency.
 - 4.2. In considering the request, the Type Approval Authority shall determine whether compliance with the requirements of this annex is infeasible or unreasonable.

The Type Approval Authority shall take into consideration data from the manufacturer that details such factors as, but not limited to, technical feasibility, lead time and production cycles including phase-in or phase-out of engines or vehicle designs and programmed upgrades of computers, the extent to which the resultant OBD system will be effective in complying with the requirements of this Regulation and that the manufacturer has demonstrated an acceptable level of effort towards compliance with the requirements of this Regulation.
 - 4.2.1. The Type Approval Authority shall not accept any deficiency request that includes the complete lack of a required diagnostic monitor or the lack of mandated recording and reporting of data related to a monitor.
 - 4.2.2. The Type Approval Authority will not accept any deficiency request that does not respect the OBD thresholds set out in paragraph 6.8.2. of this Regulation.
 - 4.3. In determining the identified order of deficiencies, deficiencies relating to paragraphs 3.3.3.1., 3.3.3.2. and 3.3.3.3. of this annex for positive ignition engines and paragraphs 3.3.4.1., 3.3.4.2. and 3.3.4.3. of this annex for compression-ignition engines shall be identified first.
 - 4.4. Prior to or at the time of type approval, no deficiency shall be granted in respect of the requirements of paragraph 6.5., except paragraph 6.5.3.4., of Appendix 1 to this annex.
 - 4.5. Deficiency period
 - 4.5.1. A deficiency may be carried-over for a period of two years after the date of type-approval unless it can be adequately demonstrated that substantial vehicle hardware modifications and additional lead-time beyond two years would be necessary to correct the deficiency. In such a case, the deficiency may be carried-over for a period not exceeding three years.
 - 4.5.2. A manufacturer may request that the Type Approval Authority grant a deficiency retrospectively when such a deficiency is discovered after the original type-approval. In this case, the deficiency may be carried-over for a period of two years after the date of notification to the Type Approval

Authority unless it can be adequately demonstrated that substantial vehicle hardware modifications and additional lead-time beyond two years would be necessary to correct the deficiency. In such a case, the deficiency may be carried-over for a period not exceeding three years.

- 4.6. At the request of the manufacturer, a vehicle with an OBD system may be accepted for type-approval with regard to emissions, even though the system contains one or more deficiencies such that the specific requirements of this annex are not fully met, provided that the specific administrative provisions set out in section paragraph 3 of this annex are complied with.

The Type Approval Authority shall notify its decision in granting a deficiency request to all other Contracting Parties to the 1958 Agreement applying this Regulation.

Annex C5 - Appendix 1

Functional aspects of On-Board Diagnostic (OBD) systems

1. Introduction

This appendix describes the procedure of the test according to paragraph 3. of this annex. The procedure describes a method for checking the function of the On-Board Diagnostic (OBD) system installed on the vehicle by failure simulation of relevant systems in the engine management or emission control system. It also sets procedures for determining the durability of OBD systems.

The manufacturer shall make available the defective components and/or electrical devices which would be used to simulate failures. When measured over the Type 1 test cycle, such defective components or devices shall not cause the vehicle emissions to exceed the OBD thresholds set out in Table 4A and Table 4B (as applicable) in paragraph 6.8.2. of this Regulation by more than 20 per cent. For electrical failures (short/open circuit), the emissions may exceed these OBD thresholds by more than twenty per cent.

When the vehicle is tested with the defective component or device fitted, the OBD system is approved if the MI is activated. The OBD system is also approved if the MI is activated below the OBD thresholds.

2. Description of test

2.1. The testing of OBD systems consists of the following phases:

2.1.1. Simulation of malfunction of a component of the engine management or emission control system;

2.1.2. Preconditioning of the vehicle with a simulated malfunction over preconditioning specified in paragraph 6.2.1. or paragraph 6.2.2. of this appendix;

2.1.3. Driving the vehicle with a simulated malfunction over the Type 1 test cycle and measuring the emissions of the vehicle. When driving the vehicle with a simulated malfunction, the drive trace indices and tolerances set out in paragraph 2.6.8.3.2. of Annex B6 shall not apply;

2.1.4. Determining whether the OBD system reacts to the simulated malfunction and indicates malfunction in an appropriate manner to the vehicle driver.

2.2. Alternatively, at the request of the manufacturer, malfunction of one or more components may be electronically simulated according to the requirements of paragraph 6. of this appendix.

2.3. Manufacturers may request that monitoring take place outside the Type 1 test cycle if it can be demonstrated to the Type Approval Authority that monitoring during conditions encountered during the Type 1 test cycle would impose restrictive monitoring conditions when the vehicle is used in service.

3. Test vehicle and fuel

3.1. Vehicle

The test vehicle shall meet the requirements of paragraph 2.3. of Annex B6 to this Regulation.

3.2. Fuel

The appropriate reference fuel as described in Annex B3 to this Regulation shall be used for testing. The fuel type for each failure mode to be tested (described in paragraph 6.3. of this appendix) may be selected by the Type Approval Authority from the reference fuels described in Annex B3 to this Regulation in the case of the testing of a mono-fuelled gas vehicle or of a bi-

fuelled gas vehicle. The selected fuel type shall not be changed during any of the test phases (described in paragraphs 2.1. to 2.3. of this appendix). In the case of the use of LPG or NG/biomethane as a fuel it is permissible that the engine is started on petrol and switched to LPG or NG/biomethane after a pre-determined period of time which is controlled automatically and not under the control of the driver.

4. Test temperature and pressure
 - 4.1. The test temperature and pressure shall meet the requirements of the Type 1 test as described in Annex B6 to this Regulation.
5. Test equipment
 - 5.1. Chassis dynamometer

The chassis dynamometer shall meet the requirements of Annex B5 to this Regulation.
6. OBD test procedure

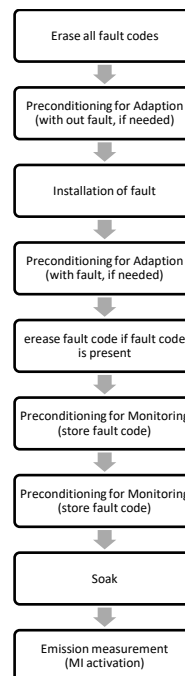


Figure C5.App1/1 Overview of demonstration test

- 6.1. The operating cycle on the chassis dynamometer shall be the applicable WLTC driven in the Type 1 test, as specified in Annexes Part B.
 - 6.1.1. The Type 1 test need not be performed for the demonstration of electrical failures (short/open circuit). The manufacturer may demonstrate these failure modes using driving conditions in which the component is used and the monitoring conditions are encountered. These conditions shall be reported in the type approval documentation.
 - 6.1.2. At the beginning of each failure mode to be demonstrated, the fault code memory shall be cleared.
- 6.2. Vehicle preconditioning
 - 6.2.1. Preconditioning for adaption

Preconditioning for adaption consists of two parts

 - (a) Preconditioning for adaption without fault

(b) Preconditioning for adaption with fault

upon the choice of the manufacturer.

The preconditioning for adaption consists of one or more consecutive WLTC 3-phase tests. At the request of the manufacturer and with the approval of the Type Approval Authority, alternative method for adaption may be used instead of 3-phase-tests.

If the fault code is stored after preconditioning for adaption, manufacturer shall delete the fault code.

- 6.2.2. Preconditioning for Monitoring
- 6.2.2.1. According to the engine type and after introduction of one of the failure modes given in paragraph 6.3. of this appendix, the vehicle shall be preconditioned by driving at least two consecutive 3-phase-WLTC tests.
- 6.2.3. At the request of the manufacturer with approval by Type Approval Authority, alternative preconditioning methods may be used.
- The reason for the use of additional preconditioning cycles or alternative preconditioning methods as well as details of these cycles/methods shall be reported in the type approval documentation.
- 6.3. Failure modes to be tested
- 6.3.1. Positive ignition engined vehicles:
- 6.3.1.1. Replacement of the catalyst with a deteriorated or defective catalyst or electronic simulation of such a failure;
- 6.3.1.2. Engine misfire conditions according to the conditions for misfire monitoring given in paragraph 3.3.3.2. of this annex;
- 6.3.1.3. Replacement of the oxygen sensor with a deteriorated or defective oxygen sensor or electronic simulation of such a failure;
- 6.3.1.4. Electrical disconnection of any other emission-related component connected to a power-train management computer (if active on the selected fuel type);
- 6.3.1.5. Electrical disconnection of the electronic evaporative purge control device (if equipped and if active on the selected fuel type).
- 6.3.2. Compression-ignition engined vehicles:
- 6.3.2.1. Where fitted, replacement of the catalyst with a deteriorated or defective catalyst or electronic simulation of such a failure.
- 6.3.2.2. Where fitted, total removal of the particulate trap or, where sensors are an integral part of the trap, a defective trap assembly.
- 6.3.2.3. Electrical disconnection of any fuelling system electronic fuel quantity and timing actuator.
- 6.3.2.4. Electrical disconnection of any other emission-related component connected to a power-train management computer.
- 6.3.2.5. In meeting the requirements of paragraphs 6.3.2.3. and 6.3.2.4. of this appendix, and with the agreement of the Type Approval Authority, the manufacturer shall take appropriate steps to demonstrate that the OBD system will indicate a fault when disconnection occurs.
- 6.3.2.6. The manufacturer shall demonstrate that malfunctions of the EGR flow and cooler are detected by the OBD system during its approval test.
- 6.4. OBD system test
- 6.4.1. Vehicles fitted with positive ignition engines:
- 6.4.1.1. After vehicle preconditioning according to paragraph 6.2. of this appendix, the test vehicle is driven over a Type 1 test.

The MI shall be activated at the latest before the end of this test under any of the conditions given in paragraphs 6.4.1.2. to 6.4.1.6. of this appendix. The MI may also be activated during preconditioning. The Technical Service may substitute those failure modes with others in accordance with paragraph 3.3.3.4. of this annex. However, the total number of failures simulated shall not exceed four (4) for the purpose of type approval.

In the case of testing a bi-fuel gas vehicle, both fuel types shall be used within the maximum of four (4) simulated failures at the discretion of the Type Approval Authority.

- 6.4.1.2. Replacement of a catalyst with a deteriorated or defective catalyst or electronic simulation of a deteriorated or defective catalyst that results in emissions exceeding the NMHC OBD threshold or the NO_x OBD threshold set out in paragraph 6.8.2. of this Regulation.
- 6.4.1.3. An induced misfire condition according to the conditions for misfire monitoring given in paragraph 3.3.3.2. of this annex that results in emissions exceeding any of the OBD thresholds set out in paragraph 6.8.2. of this Regulation.
- 6.4.1.4. Replacement of an oxygen sensor with a deteriorated or defective oxygen sensor or electronic simulation of a deteriorated or defective oxygen sensor that results in emissions exceeding any of the OBD thresholds set out in paragraph 6.8.2. of this Regulation.
- 6.4.1.5. Electrical disconnection of the electronic evaporative purge control device (if equipped and if active on the selected fuel type).
- 6.4.1.6. Electrical disconnection of any other emission-related power-train component connected to a computer that results in emissions exceeding any of the OBD thresholds set out in paragraph 6.8.2. of this Regulation (if active on the selected fuel type).

6.4.2. Vehicles fitted with compression-ignition engines:

- 6.4.2.1. After vehicle preconditioning according to paragraph 6.2. of this appendix, the test vehicle is driven over a Type 1 test.

The MI shall be activated at the latest before the end of this test under any of the conditions given in paragraphs 6.4.2.2. to 6.4.2.5 of this appendix. The MI may also be activated during preconditioning. The technical service may substitute those failure modes by others in accordance with paragraph 3.3.4.4. of this annex. However, the total number of failures simulated shall not exceed four (4) for the purposes of type approval.

- 6.4.2.2. Where fitted, replacement of a catalyst with a deteriorated or defective catalyst or electronic simulation of a deteriorated or defective catalyst that results in emissions exceeding OBD thresholds set out in paragraph 6.8.2. of this Regulation.
- 6.4.2.3. Where fitted, total removal of the particulate trap or replacement of the particulate trap with a defective particulate trap meeting the conditions of paragraph 6.3.2.2. of this appendix that results in emissions exceeding the OBD thresholds set out in paragraph 6.8.2. of this Regulation.
- 6.4.2.4. With reference to paragraph 6.3.2.5. of this appendix, disconnection of any fuelling system electronic fuel quantity and timing actuator that results in emissions exceeding any of the OBD thresholds set out in paragraph 6.8.2. of this Regulation.
- 6.4.2.5. With reference to paragraph 6.3.2.5. of this appendix, disconnection of any other emission-related power-train component connected to a computer that results in emissions exceeding any of the OBD thresholds set out in paragraph 6.8.2. of this Regulation.

- 6.5. Diagnostic signals
- 6.5.1. Reserved
- 6.5.1.1. Upon determination of the first malfunction of any component or system, "freeze-frame" engine conditions present at the time shall be stored in computer memory. Should a subsequent fuel system or misfire malfunction occur, any previously stored freeze-frame conditions shall be replaced by the fuel system or misfire conditions (whichever occurs first). Stored engine conditions shall include, but are not limited to calculated load value, engine speed (RPM), fuel trim value(s) (if available), fuel pressure (if available), vehicle speed (if available), engine coolant temperature, intake manifold pressure (if available), fuel system status (e.g. closed-loop, open-loop) (if available) and the fault code which caused the data to be stored. The manufacturer shall choose the most appropriate set of conditions facilitating effective repairs for freeze-frame storage. Only one frame of data is required. Manufacturers may choose to store additional frames provided that at least the required frame can be read by a generic scan tool meeting the specifications of paragraphs 6.5.3.2. and 6.5.3.3. of this appendix. If the fault code causing the conditions to be stored is erased in accordance with paragraph 3.8. of this annex, the stored engine conditions may also be erased.
- 6.5.1.2. If available, the following signals in addition to the required freeze-frame information shall be made available on demand through the serial port on the standardised data link connector, if the information is available to the on-board computer or can be determined using information available to the on-board computer: number of diagnostic trouble codes, engine coolant temperature, fuel system status (e.g. closed-loop, open-loop), fuel trim, ignition timing advance, intake air temperature, intake manifold air pressure, air flow rate, engine speed (RPM), throttle position sensor output value, secondary air status (upstream, downstream or atmosphere), calculated load value, vehicle speed, fuel pressure, oxygen sensor, lambda sensor, and number of fault code.
- The signals shall be provided in standard units based on the specifications given in paragraph 6.5.3. of this appendix. Actual signals shall be clearly identified separately from default value or limp-home signals.
- 6.5.1.3. For all emission control systems for which specific on-board evaluation tests are conducted (catalyst, oxygen sensor, etc.), except misfire detection, fuel system monitoring and comprehensive component monitoring, the results of the most recent test performed by the vehicle and the limits to which the system is compared shall be made available through the serial data port on the standardised data link connector according to the specifications given in paragraph 6.5.3. of this appendix. For the monitored components and systems excepted above, a pass/fail indication for the most recent test results shall be available through the data link connector.
- All data required to be stored in relation to OBD in-use performance according to the provisions of paragraph 7.6. of this appendix shall be available through the serial data port on the standardized data link connector according to the specifications given in paragraph 6.5.3. of this appendix.
- 6.5.1.4. The OBD requirements to which the vehicle is certified and the major emission control systems monitored by the OBD system consistent with paragraph 6.5.3.3. of this appendix shall be available through the serial data port on the standardised data link connector according to the specifications given in paragraph 6.5.3. of this appendix.
- 6.5.1.5. For all types of vehicles entering into service, the software calibration identification number shall be made available through the serial port on the standardised data link connector. The software calibration identification number shall be provided in a standardised format.

- 6.5.2. The emission control diagnostic system is not required to evaluate components during malfunction if such evaluation would result in a risk to safety or component failure.
- 6.5.3. The emission control diagnostic system shall provide for standardised and unrestricted access and conform to the following ISO standards and/or SAE specification. Later versions may be used at the manufacturers' discretion.
- 6.5.3.1. The following standard shall be used as the on-board to off-board communications link:
- (a) ISO 15765-4:2011 "Road vehicles – Diagnostics on Controller Area Network (CAN) – Part 4: Requirements for emissions-related systems", dated 1 February 2011.
- 6.5.3.2. Standards used for the transmission of OBD relevant information:
- (a) ISO 15031-5 "Road vehicles - communication between vehicles and external test equipment for emissions-related diagnostics – Part 5: Emissions-related diagnostic services", dated 1 April 2011 or SAE J1979 dated 23 February 2012;
- (b) ISO 15031-4 "Road vehicles – Communication between vehicle and external test equipment for emissions related diagnostics – Part 4: External test equipment", dated 1 June 2005 or SAE J1978 dated 30 April 2002;
- (c) ISO 15031-3 "Road vehicles – Communication between vehicle and external test equipment for emissions related diagnostics Part 3: Diagnostic connector and related electrical circuits: specification and use", dated 1 July 2004 or SAE J 1962 dated 26 July 2012;
- (d) ISO 15031-6 "Road vehicles – Communication between vehicle and external test equipment for emissions related diagnostics – Part 6: Diagnostic trouble code definitions", dated 13 August 2010 or SAE J2012 dated 07 March 2013;
- (e) ISO 27145 "Road vehicles – Implementation of World-Wide Harmonized On-Board Diagnostics (WWH-OBD)" dated 2012-08-15 with the restriction, that only 6.5.3.1.(a) may be used as a data link;
- (f) ISO 14229:2013 "Road vehicles – Unified diagnostic services (UDS) with the restriction, that only 6.5.3.1.(a) may be used as a data link".

The standards (e) and (f) may be used as an option instead of (a).

- 6.5.3.3. Test equipment and diagnostic tools needed to communicate with OBD systems shall meet or exceed the functional specification given in the standard listed in paragraph 6.5.3.2.(b) of this appendix.

- 6.5.3.4. Basic diagnostic data, (as specified in paragraph 6.5.1.) and bi-directional control information shall be provided using the format and units described in the standard listed in paragraph 6.5.3.2.(a) of this appendix and must be available using a diagnostic tool meeting the requirements of the standard listed in paragraph 6.5.3.2.(b) of this appendix.

The vehicle manufacturer shall provide to a national standardisation body the details of any emission-related diagnostic data, e.g. PID's, OBD monitor Id's, Test ID's not specified in the standard listed in paragraph 6.5.3.2.(a) of this Regulation but related to this Regulation.

- 6.5.3.5. When a fault is registered, the manufacturer shall identify the fault using an appropriate ISO/SAE controlled fault code specified in one of the standards listed in paragraph 6.5.3.2.(d) of this appendix relating to "emission related system diagnostic trouble codes". If such identification is not possible, the manufacturer may use manufacturer controlled diagnostic trouble codes according to the same standard. The fault codes shall be fully accessible by

- standardised diagnostic equipment complying with the provisions of paragraph 6.5.3.3. of this appendix.
- 6.5.3.6. The connection interface between the vehicle and the diagnostic tester shall be standardised and shall meet all the requirements of the standard listed in paragraph 6.5.3.2.(c) of this appendix. The installation position shall be subject to agreement of the administrative department such that it is readily accessible by service personnel but protected from tampering by non-qualified personnel.
7. In-use performance
- 7.1. General requirements
- 7.1.1. Each monitor of the OBD system shall be executed at least once per driving cycle in which the monitoring conditions as specified in paragraph 7.2. of this appendix are met. Manufacturers may not use the calculated ratio (or any element thereof) or any other indication of monitor frequency as a monitoring condition for any monitor.
- 7.1.2. The In-Use Performance Ratio (IUPR) of a specific monitor M of the OBD systems and in-use performance of pollution control devices shall be:
- $$IUPR_M = \text{Numerator}_M / \text{Denominator}_M$$
- 7.1.3. Comparison of numerator and denominator gives an indication of how often a specific monitor is operating relative to vehicle operation. To ensure all manufacturers are tracking $IUPR_M$ in the same manner, detailed requirements are given for defining and incrementing these counters.
- 7.1.4. If, according to the requirements of this annex, the vehicle is equipped with a specific monitor M, $IUPR_M$ shall be greater or equal to the following minimum values:
- (a) 0.260 for secondary air system monitors and other cold start related monitors;
 - (b) 0.520 for evaporative emission purge control monitors;
 - (c) 0.336 for all other monitors.
- 7.1.5. Vehicles shall comply with the requirements of paragraph 7.1.4. of this appendix for a mileage of at least the target useful life, as defined in paragraph 6.7. of this Regulation.
- 7.1.6. The requirements of this paragraph are deemed to be met for a particular monitor M, if for all vehicles of a particular OBD family manufactured in a particular calendar year the following statistical conditions hold:
- (a) The average $IUPR_M$ is equal or above the minimum value applicable to the monitor;
 - (b) More than 50 per cent of all vehicles have an $IUPR_M$ equal or above the minimum value applicable to the monitor.
- 7.2. Numerator_M
- 7.2.1. The numerator of a specific monitor is a counter measuring the number of times a vehicle has been operated such that all monitoring conditions necessary for the specific monitor to detect a malfunction in order to warn the driver, as they have been implemented by the manufacturer, have been encountered. The numerator shall not be incremented more than once per driving cycle, unless there is reasoned technical justification.
- 7.3. Denominator_M
- 7.3.1. The purpose of the denominator is to provide a counter indicating the number of vehicle driving events, taking into account special conditions for a specific monitor. The denominator shall be incremented at least once per driving cycle, if during this driving cycle such conditions are met and the general

denominator is incremented as specified in paragraph 7.5. of this appendix unless the denominator is disabled according to paragraph 7.7. of this appendix.

7.3.2. In addition to the requirements of paragraph 7.3.1. of this appendix:

- (a) Secondary air system monitor denominator(s) shall be incremented if the commanded "on" operation of the secondary air system occurs for a time greater than or equal to 10 seconds. For purposes of determining this commanded "on" time, the OBD system may not include time during intrusive operation of the secondary air system solely for the purposes of monitoring.
- (b) Denominators of monitors of systems only active during cold start shall be incremented if the component or strategy is commanded "on" for a time greater than or equal to 10 seconds.
- (c) The denominator(s) for monitors of Variable Valve Timing (VVT) and/or control systems shall be incremented if the component is commanded to function (e.g., commanded "on", "open", "closed", "locked", etc.) on two or more occasions during the driving cycle or for a time greater than or equal to 10 seconds, whichever occurs first.
- (d) For the following monitors, the denominator(s) shall be incremented by one if, in addition to meeting the requirements of this paragraph on at least one driving cycle, at least 800 cumulative kilometres of vehicle operation have been experienced since the last time the denominator was incremented:
 - (i) Diesel oxidation catalyst;
 - (ii) Diesel particulate filter.
- (e) Without prejudice to requirements for the increment of denominators of other monitors the denominators of monitors of the following components shall be incremented if and only if the driving cycle started with a cold start:
 - (i) Liquid (oil, engine coolant, fuel, SCR reagent) temperature sensors;
 - (ii) Clean air (ambient air, intake air, charge air, inlet manifold) temperature sensors;
 - (iii) Exhaust (EGR recirculation/cooling, exhaust gas turbo-charging, catalyst) temperature sensors;
- (f) The denominators of monitors of the boost pressure control system shall be incremented if all of the following conditions are met:
 - (i) The general denominator conditions are fulfilled;
 - (ii) The boost pressure control system is active for a time greater than or equal to 15 seconds.
- (g) Manufacturers may request to use special denominator conditions for certain components or systems and this request can be approved only if it can be demonstrated to the Type Approval Authority by submitting data and/or an engineering evaluation that other conditions are necessary to allow for reliable detection of malfunctions.

7.3.3. For hybrid vehicles, vehicles that employ alternative engine start hardware or strategies (e.g. integrated starter and generators), or alternative fuel vehicles (e.g. dedicated, bi-fuel, or dual-fuel applications), the manufacturer may request the approval of the Type Approval Authority to use alternative criteria to those set out in this paragraph for incrementing the denominator. In general, the Type Approval Authority shall not approve alternative criteria for vehicles

that only employ engine shut off at or near idle/vehicle stop conditions. Approval by the Type Approval Authority of the alternative criteria shall be based on the equivalence of the alternative criteria to determine the amount of vehicle operation relative to the measure of conventional vehicle operation in accordance with the criteria in this paragraph.

- 7.4. Ignition cycle counter
- 7.4.1. The ignition cycle counter indicates the number of ignition cycles a vehicle has experienced. The ignition cycle counter may not be incremented more than once per driving cycle.
- 7.5. General denominator
- 7.5.1. The general denominator is a counter measuring the number of times a vehicle has been operated. It shall be incremented within 10 seconds, if and only if, the following criteria are satisfied on a single driving cycle:
- (a) Cumulative time since engine start is greater than or equal to 600 seconds while at an elevation of less than 2,440 m above sea level and at an ambient temperature of greater than or equal to -7°C ;
 - (b) Cumulative vehicle operation at or above 40 km/h occurs for greater than or equal to 300 seconds while at an elevation of less than 2,440 m above sea level and at an ambient temperature of greater than or equal to -7°C ;
 - (c) Continuous vehicle operation at idle (i.e. accelerator pedal released by driver and vehicle speed less than or equal to 1.6 km/h) for greater than or equal to 30 seconds while at an elevation of less than 2,440 m above sea level and at an ambient temperature of greater than or equal to -7°C .
- 7.6. Reporting and increasing counters
- 7.6.1. The OBD system shall report, in accordance with the ISO 15031-5 specifications of the standard listed in paragraph 6.5.3.2.(a) of this appendix, the ignition cycle counter and general denominator as well as separate numerators and denominators for the following monitors, if their presence on the vehicle is required by this annex:
- (a) Catalysts (each bank to be reported separately);
 - (b) Oxygen/exhaust gas sensors, including secondary oxygen sensors (each sensor to be reported separately);
 - (c) Evaporative system;
 - (d) EGR system;
 - (e) VVT system;
 - (f) Secondary air system;
 - (g) Particulate filter;
 - (h) NO_x after-treatment system (e.g. NO_x adsorber, NO_x reagent/catalyst system);
 - (i) Boost pressure control system.
- 7.6.2. For specific components or systems that have multiple monitors, which are required to be reported by this point (e.g. oxygen sensor bank 1 may have multiple monitors for sensor response or other sensor characteristics), the OBD system shall separately track numerators and denominators for each of the specific monitors and report only the corresponding numerator and denominator for the specific monitor that has the lowest numerical ratio. If two or more specific monitors have identical ratios, the corresponding numerator

and denominator for the specific monitor that has the highest denominator shall be reported for the specific component.

- 7.6.2.1. Numerators and denominators for specific monitors of components or systems, that are monitoring continuously for short circuit or open circuit failures are exempted from reporting.
- "Continuously", if used in this context means monitoring is always enabled and sampling of the signal used for monitoring occurs at a rate no less than two samples per second and the presence or the absence of the failure relevant to that monitor has to be concluded within 15 seconds.
- If for control purposes, a computer input component is sampled less frequently, the signal of the component may instead be evaluated each time sampling occurs.
- It is not required to activate an output component/system for the sole purpose of monitoring that output component/system.
- 7.6.3. All counters, when incremented, shall be incremented by an integer of one.
- 7.6.4. The minimum value of each counter is 0, the maximum value shall not be less than 65,535, notwithstanding any other requirements on standardised storage and reporting of the OBD system.
- 7.6.5. If either the numerator or denominator for a specific monitor reaches its maximum value, both counters for that specific monitor shall be divided by two before being incremented again according to the provisions set in paragraphs 7.2. and 7.3. of this appendix. If the ignition cycle counter or the general denominator reaches its maximum value, the respective counter shall change to zero at its next increment according to the provisions set in paragraphs 7.4. and 7.5. of this appendix, respectively.
- 7.6.6. Each counter shall be reset to zero only when a non-volatile memory reset occurs (e.g. reprogramming event, etc.) or, if the numbers are stored in keep-alive memory (KAM), when KAM is lost due to an interruption in electrical power to the control module (e.g. battery disconnect, etc.).
- 7.6.7. The manufacturer shall take measures to ensure that the values of numerator and denominator cannot be reset or modified, except in cases provided for explicitly in this paragraph.
- 7.7. Disablement of numerators and denominators and of the general denominator
- 7.7.1. Within 10 seconds of a malfunction being detected, which disables a monitor required to meet the monitoring conditions of this annex (i.e. a pending or confirmed code is stored), the OBD system shall disable further incrementing of the corresponding numerator and denominator for each monitor that is disabled. When the malfunction is no longer detected (i.e., the pending code is erased through self-clearing or through a scan tool command), incrementing of all corresponding numerators and denominators shall resume within 10 seconds.
- 7.7.2. Within 10 seconds of the start of a Power Take-off Operation (PTO) that disables a monitor required to meet the monitoring conditions of this annex, the OBD system shall disable further incrementing of the corresponding numerator and denominator for each monitor that is disabled. When the PTO operation ends, incrementing of all corresponding numerators and denominators shall resume within 10 seconds.
- 7.7.3. The OBD system shall disable further incrementing of the numerator and denominator of a specific monitor within 10 seconds, if a malfunction of any component used to determine the criteria within the definition of the specific monitor's denominator (i.e. vehicle speed, ambient temperature, elevation, idle operation, engine cold start, or time of operation) has been detected and the corresponding pending fault code has been stored. Incrementing of the

numerator and denominator shall resume within 10 seconds when the malfunction is no longer present (e.g. pending code erased through self-clearing or by a scan tool command).

- 7.7.4. The OBD system shall disable further incrementing of the general denominator within 10 seconds, if a malfunction has been detected of any component used to determine whether the criteria in paragraph 7.5. of this appendix are satisfied (i.e. vehicle speed, ambient temperature, elevation, idle operation, or time of operation) and the corresponding pending fault code has been stored. The general denominator may not be disabled from incrementing for any other condition. Incrementing of the general denominator shall resume within 10 seconds when the malfunction is no longer present (e.g. pending code erased through self-clearing or by a scan tool command).
