

ECONOMIC COMMISSION FOR EUROPE

SIGNI

European Code for Signs and Signals on Inland Waterways

Resolution No. 90



UNITED NATIONS

New York and Geneva, 2018

Note

The designations employed and the presentation of the material in this publication do not imply the expression of any opinion whatsoever on the part of the Secretariat of the United Nations concerning the legal status of any country, territory, city or area, or of its authorities, or concerning the delimitation of its frontiers or boundaries.

ECE/TRANS/SC.3/208

UNITED NATIONS PUBLICATION

Sales No. E.19.II.E.1

ISBN 978-92-1-117179-2

eISBN 978-92-1-047419-1

Copyright © United Nations, 2018

All rights reserved.

No part of this publication may, for sales purposes, be reproduced, stored in a retrieval system or transmitted in any form or by any means, electronic, electrostatic, magnetic tape, mechanical, photocopying or otherwise, without prior permission in writing from the United Nations.

United Nations Economic Commission for Europe

The United Nations Economic Commission for Europe (UNECE) is one of the five United Nations regional commissions, administered by the Economic and Social Council (ECOSOC). It was established in 1947 with the mandate to help rebuild post-war Europe, develop economic activity and strengthen economic relations among European countries, and between Europe and the rest of the world. During the Cold War, UNECE served as a unique forum for economic dialogue and cooperation between East and West. Despite the complexity of this period, significant achievements were made, with consensus reached on numerous harmonization and standardization agreements.

In the post-Cold War era, UNECE acquired not only many new member States, but also new functions. Since the early 1990s the organization has focused on analyses of the transition process, using its harmonization experience to facilitate the integration of Central and Eastern European countries into the global markets.

UNECE is the forum where the countries of western, central and eastern Europe, central Asia and North America – 56 countries in all – come together to forge the tools of their economic cooperation. That cooperation concerns economics, statistics, environment, transport, trade, sustainable energy, timber and habitat. The Commission offers a regional framework for the elaboration and harmonization of conventions, norms and standards. The Commission's experts provide technical assistance to the countries of South-East Europe and the Commonwealth of Independent States. This assistance takes the form of advisory services, training seminars and workshops where countries can share their experiences and best practices.

Transport in UNECE

The UNECE Sustainable Transport Division is the secretariat of the Inland Transport Committee (ITC) and the ECOSOC Committee of Experts on the Transport of Dangerous Goods and on the Globally Harmonized System of Classification and Labelling of Chemicals. The ITC and its 17 working parties, as well as the ECOSOC Committee and its sub-committees are intergovernmental decision-making bodies that work to improve the daily lives of people and businesses around the world, in measurable ways and with concrete actions, to enhance traffic safety, environmental performance, energy efficiency and the competitiveness of the transport sector.

The ECOSOC Committee was set up in 1953 by the Secretary-General of the United Nations at the request of the Economic and Social Council to elaborate recommendations on the transport of dangerous goods. Its mandate was extended to the global (multi-sectoral) harmonization of systems of classification and labelling of chemicals in 1999. It is composed of experts from countries which possess the relevant expertise and experience in the international trade and transport of dangerous goods and chemicals. Its membership is restricted in order to reflect a proper geographical balance between all regions of the world and to ensure adequate participation of developing countries. Although the Committee is a subsidiary body of ECOSOC, the Secretary-General decided in 1963 that the secretariat services would be provided by the UNECE Sustainable Transport Division.

ITC is a unique intergovernmental forum that was set up in 1947 to support the reconstruction of transport connections in post-war Europe. Over the years, it has specialized in facilitating the harmonized and sustainable development of inland modes of transport. The main results of this persevering and ongoing work are reflected, among other things, (i) in 58 United Nations conventions and many more technical regulations, which are updated on a regular basis and provide an international legal framework for the sustainable development of national and international road, rail, inland water and intermodal transport, including the transport of dangerous goods, as well as the construction and inspection of road motor vehicles; (ii) in the Trans-European North-south Motorway, Trans-European Railway and the Euro-Asia Transport Links projects, that facilitate multi-country coordination of transport infrastructure investment programmes; (iii) in the TIR system, which is a global customs transit facilitation solution; (iv) in the tool called For Future Inland Transport Systems (ForFITS), which can assist national and local governments to monitor carbon dioxide (CO₂) emissions coming from inland transport modes and to select and design climate change mitigation policies, based on their impact and adapted to local conditions; (v) in transport statistics – methods and data – that are internationally agreed on; (vi) in studies and reports that help transport policy development by addressing timely issues, based on cutting-edge research and analysis. ITC also devotes special attention to Intelligent Transport Services (ITS), sustainable urban mobility and city logistics, as well as to increasing the resilience of transport networks and services in response to climate change adaptation and security challenges.

In addition, the UNECE Sustainable Transport and Environment Divisions, together with the World Health Organization (WHO) – Europe, co-service the Transport Health and Environment Pan-European Programme (THE PEP).

Finally, as of 2015, the UNECE Sustainable Transport Division is providing the secretariat services for the Secretary General's Special Envoy for Road Safety Mr. Jean Todt.

Foreword

Since its establishment by the Inland Transport Committee of the United Nations Economic Commission for Europe (UNECE) in 1956, the Sub-Committee on Inland Water Transport, (the Working Party on Inland Water Transport, or SC.3 since 1970) has focused on developing and maintaining harmonized navigation rules in order to facilitate traffic on inland waterways and ensure safety. These rules cover the European Code for Inland Waterways (CEVNI) and the signs and signals on inland waterways.

SC.3 adopted Resolution No. 1 of 28 August 1957 on the Standardization of Signalling Systems on Inland Waterways, with a purpose of establishing a homogeneous system of signs, signals and marking on inland waterways harmonized with the maritime buoyage system. This was subsequently replaced in 1982 by Resolution No. 22 "SIGNI – Signs and Signals on Inland Waterways", after the adoption of a new maritime buoyage system by the International Association of Marine Aids to Navigation and Lighthouse Authorities (IALA). Resolution No. 22 was then subsequently revised in 2005 and 2010.

Following the decision of SC.3 at its sixtieth session in 2016 on the revision of SIGNI, the provisions have been significantly updated and brought in line with the fifth revision of CEVNI. This work has been accomplished with the participation of River Commissions and the CEVNI Expert Group as well as contributions from the Chairs of the Joint International VTT and Inland ECDIS Expert Group and IALA.

The European Code for Signs and Signals on Inland Waterways (SIGNI) provides recommendations for the competent authorities for the installation and application of buoyage and marking on European inland waterways contained in the fifth revision of CEVNI (ECE/TRANS/SC.3/115/Rev.5).

This new edition of SIGNI is based on revision 2 of Resolution No. 22, and the Guidelines for Waterways Signs and Marking (Resolution No. 59, revision 2). The present SIGNI replaces the annex to Resolution No. 22 as amended by resolutions Nos. 29, 51 and 67 (ECE/TRANS/SC.3/108/Rev.2) and the annex to Resolution No. 59 as amended by Resolutions Nos. 75 and 85 (ECE/TRANS/SC.3/169/Rev.2). It contains two new chapters on the monitoring of signs and marking by AIS aids to navigation (chapter 13) and on the regional and national special requirements (chapter 14).

Contents

SIGNI – European Code for Signs and Signals on Inland Waterways – Resolution No. 90 x

Annex to Resolution No. 90 EUROPEAN CODE FOR SIGNS AND SIGNALS ON INLAND WATERWAYS (SIGNI)..... 1

Chapter 1 - General 1

1.1	General principles.....	1
1.2	Lights.....	3
1.3	Boards and buoys.....	3
1.4	Geographical limits of applicability of the marking system recommended.....	3

Chapter 2 - Visibility of signs and lights 5

2.1	General provisions.....	5
2.2	Conditions of visibility and dimensions of signs.....	5
2.3	Conditions for the visibility of lights and lighting.....	7
2.4	Obligation not to hinder road and rail traffic.....	7

Chapter 3 - Buoyage and marking of the waterway 9

3.1	Requirements to be met by signs and marks and their marking plan.....	9
3.2	Buoyage of fairway limits in the waterway.....	10
3.3	Buoyage and marking of danger points and obstacles.....	12
3.4	Bank marks indicating the position of the fairway.....	17
3.5	Buoyage and marking of lakes and broad waterways.....	18
3.6	Additional marking for navigation by radar.....	20
3.7	Buoys for miscellaneous purposes.....	21
3.8	Warning posts.....	21

Chapter 4 - Buoyage and marking of lakes and broad waterways 23

4.1	General.....	23
4.2	Marking of danger points, obstacles and special features.....	23
4.3	Marking of the axis of a channel, the middle of a channel or a landfall.....	25
4.4	Special marks.....	26
4.5	Weather signs and signals on lakes.....	26
4.6	Example of signs and signals on lakes and broad waterways.....	26

Chapter 5 - Lights 29

5.1	Definitions.....	29
5.2	Fixed lights.....	29
5.3	Rhythmic lights.....	31
5.4	Additional luminous signal.....	31
5.5	Semaphores.....	31

Chapter 6 - Installation of signs and marking in characteristic sections of the river	33
6.1 General	33
6.2 Marking of meandering sectors.....	35
6.3 Marking of shoals.....	38
6.4 Marking of the vicinity of bridges and passages through bridges.....	40
6.5 Installation of floating signs restricting berthing points.....	42
6.6 Reference numbers on buoys and marker posts.....	42
Chapter 7 - Marking of harbour entrances	45
Chapter 8 - Marking of permanent structures	47
8.1 General principle.....	47
8.2 Fixed bridges.....	48
8.3 Movable bridges.....	49
8.4 Weirs.....	50
8.5 Locks, ship lifts and inclined planes.....	51
Chapter 9 - Blockage of the waterway	53
9.1 Suspension of navigation for all vessels.....	53
9.2 Prohibition of navigation for motorized vessels	53
9.3 Prohibition to enter or leave a harbour or a tributary waterway	53
Chapter 10 - Marking of prohibited or restricted zones	55
Chapter 11 - Variable message signs to regulate traffic.....	57
Chapter 12 - Installation of radar reflectors	59
12.1 Installation of radar reflectors on marking signs and signals and navigable passes through bridges.....	59
12.2 Buoys and poles with radar reflectors.....	60
12.3 Marking of overhead cables (where applicable).....	60
Chapter 13 - Monitoring of signs and marking by AIS Aids to Navigation.....	63
13.1 Function of AIS Aids to Navigation	63
13.2 Types of AIS Aids to Navigation	63
Chapter 14 - Regional and national special requirements	65
14.1 Introduction	65
14.2 Chapter 1 - General.....	65
14.3 Chapter 2 - Visibility of signs and lights	65
14.4 Chapter 3 - Buoyage and marking of the waterway.....	65
14.5 Chapter 5 - Lights.....	66
14.6 Chapter 6 - Installation of signs and marking in characteristic sections of the river	67
14.7 Chapter 7 - Marking of harbour entrances	67

14.8	Chapter 8 - Marking of permanent structures.....	67
14.9	Chapter 9 - Blockage of the waterway	67
14.10	Chapter 10 - Marking of prohibited or restricted zones	67
14.11	Chapter 12 - Installation of radar reflectors	67

Appendix 1 - Minimal dimensions of the signs from annexes 7 and 8 of the European Code for Inland Waterways69

1.	Visibility of signs.....	69
2.	Minimal dimensions of the signs contained in annex 7 to the European Code for Inland Waterways.....	71
2.1	Main signs.....	71
	A. Prohibitory signs	71
	B. Mandatory signs	93
	C. Restrictive signs.....	108
	D. Recommendatory signs.....	116
	E. Informative signs	121
2.2	Auxiliary signs.....	171
	A. Panels showing the distance at which the regulation applies or the special feature indicated by the main sign is to be found	171
	B. Pointers showing the direction of the section to which the main sign applies	172
	C. Panels giving explanations or additional information	172
3.	Minimal dimensions of the signs contained in annex 8 to the European Code for Inland Waterways...	173
3.1	Buoyage of fairway limits in the waterway.....	173
	A. Right-hand side of the waterway.....	173
	B. Left-hand side of the waterway	173
	C. Bifurcation of the waterway	174
3.2	Bank marks indicating the position of the fairway.....	175
	A. Bank marks indicating the position of the fairway in relation to the banks	175
	B. Cross-overs.....	177
3.3	Buoyage and marking of danger points and obstacles.....	179
	A. Fixed marks	179
3.4	Radar reflectors on marking signs and signals and navigable passes through bridges.....	182
	A. Radar reflectors on bridges.....	182
	B. Radar reflectors on buoys and signs	183

Appendix 2 - Properties of lights.....	185
1. Categories of luminous intensity.....	185
2. Acceptable colours of lights	185
3. Calculation of light range	186
Appendix 3 - Colours of reflected light for navigation signs	189
Appendix 4 - Rhythmic lights.....	193
Appendix 5 - Recommendations for the lighting of traffic signs	201
1. General provisions.....	201
2. External backward-facing lighting of signs	201
3. Internally backlit signs.....	202
Appendix 6 - Examples of variable-message traffic signs	205
1. Mechanical boards.....	205
A. Scrolling sign boards	205
B. Trivision boards.....	205
C. Other mechanical boards	205
2. Electronic boards.....	206
A. Optical waveguide (optical fibre) boards.....	206
B. Light-emitting diode (LED) matrix boards.....	207
C. Liquid crystal displays (LCDs).....	207



SIGNI – European Code for Signs and Signals on Inland Waterways

Resolution No. 90

(adopted by the Working Party on Inland Water Transport on 5 October 2018)

The Working Party on Inland Water Transport,

Desirous, in the interest of safety of navigation, of establishing rules for waterway signs and marking harmonized with the European Code for Inland Waterways (CEVNI), as well as regulations for their installation and visualization,

Having regard to its resolution No. 22, SIGNI: Signs and Signals on Inland Waterways, as amended by resolutions Nos. 29, 51 and 67 (ECE/TRANS/SC.3/108/Rev.2),

Having regard also to its resolution No. 59, containing in its annex the Guidelines for Waterway Signs and Marking, as amended by resolutions Nos. 75 and 85 (ECE/TRANS/SC.3/169/Rev.2),

Considering its resolution No. 24, concerning the European Code for Inland Waterways (CEVNI), as amended by resolutions Nos. 26, 27, 37, 39, 43-47, 54, 62, 66 and 81 (ECE/TRANS/SC.3/115/Rev.5),

Noting that, through the application of the recommendations of these resolutions by Governments and River Commissions, the corresponding regulations in force on European inland waterways have to a large extent been harmonized,

Acknowledging the desirability, for safety of navigation, of maintaining a system of signs and signals on inland waterways harmonized with the maritime system of buoyage,

Recognizing the role of modern technologies and innovations in ensuring navigation safety and their impact on the regulations in force,

Bearing in mind the reports of the Working Party on the Standardization of Technical and Safety Requirements in Inland Navigation on its fifty-first, fifty-second and fifty-third sessions (ECE/TRANS/SC.3/WP.3/102, para. 30, ECE/TRANS/SC.3/WP.3/104, paras. 31-32, and ECE/TRANS/SC.3/WP.3/106, paras. 31-34),

1. *Decides* to replace the text of SIGNI, as reproduced in ECE/TRANS/SC.3/108/Rev.2, and the Guidelines for Waterways Signs and Marking, as reproduced in ECE/TRANS/SC.3/169/Rev.2, by the annex to this resolution, entitled "SIGNI: European Code for Signs and Signals on Inland Waterways", which is reproduced in ECE/TRANS/SC.3/208,
2. *Decides* to replace resolution No. 22, revision 2, resolution No. 59, revision 2, as well as resolutions Nos. 29, 51, 67, 75 and 85 by this resolution,
3. *Invites* Governments and River Commissions to inform the Executive Secretary of the United Nations Economic Commission for Europe whether they implement this resolution,
4. *Requests* the Executive Secretary of the United Nations Economic Commission for Europe to place the question of the application of this resolution periodically on the agenda of the Working Party on Inland Water Transport.



Annex to Resolution No. 90

EUROPEAN CODE FOR SIGNS AND SIGNALS ON INLAND WATERWAYS (SIGNI)

Chapter 1 - General

1.1 General principles

- 1.1.1 In terms of the objective pursued, the marking comprises three categories of buoyage and marking:
- (a) Buoyage of fairway limits in the waterway by means of buoys or spars, hereafter floating signs. This category will normally be used only on sections of waterway where the fairway cannot be indicated sufficiently clearly by marks placed on the banks;
 - (b) Buoyage and marking of danger points and obstacles, i.e. navigational hazards including:
 - danger points, e.g. campshot, projections of the bank, low banks liable to flooding, fixed obstacles;
 - obstacles, e.g. grounded or sunken vessels or floating equipment; work sites in the waterway, lost anchors, structures protruding into the fairway or in its vicinity etc.;
 - (c) Marks on land indicating the position of the fairway, hereafter bank marks, indicating the position of the fairway in relation to the banks and, where appropriate, its crossover from one bank to the other. The marks may also be used to provide isolated reference points for boatmasters.
- 1.1.2 Signs and signals comprise:
- (a) Signs used to regulate navigation on the waterway, set out in section 3.5, chapter 5 and appendix 1, as well as annex 7 of the European code for inland waterways (CEVNI); and
 - (b) Floating signs and bank marks, set out in chapter 3 and annex 8 of CEVNI.
- 1.1.3 The signs set out in annex 7 to CEVNI are prohibitory, mandatory, restrictive, recommendatory and informative signs as well as auxiliary signs.
- 1.1.4 In the case of lakes and broad waterways, the three categories of buoyage and marking referred to above are used. In addition, special provisions are prescribed under chapter 4.
- 1.1.5 In accordance with article 5.01 of CEVNI, vessels' crew members shall obey the requirements and take account of the recommendations or indications brought to their attention by these signs.
- 1.1.6 The number of signs, bank marks floating signs and their on-site locations shall meet the requirements of navigation safety.
- 1.1.7 In order to increase navigation safety, the competent authorities shall place kilometre markings along the inland waterway wherever waterway dimensions allow, as well as mark of each hectometre wherever possible.
- 1.1.8 Where the competent authorities decide to install a system of marking on a particular waterway or inland navigation network, they may:
- Select from among the marks covered by these provisions those which they deem suitable for the waterway or waterway network in question;
 - Supplement the marks selected with additional marks not included in the system defined below, provided always that the shape and colour of such marks and the nature of any symbol employed

are consistent with the system and are such that the additional marks cannot be confused with any of the system's existing marks.

In cases where these provisions permit alternatives, the competent authorities shall, unless there are overriding reasons to the contrary, agree on the alternative to be adopted on all of the several parts of the same waterway.

- 1.1.9 The choice of the marks and the establishment of their number depend on the local characteristics of the fairway and the function of each mark. Their installation shall be effected in cases when it is required by navigation criteria on the respective river section, in such a way as to ensure visibility from one mark to the next.
- 1.1.10 The term "left and right banks" means the sides of the waterway when moving from the source to the mouth.
- On canals, lakes and broad waterways the competent authorities shall decide the matter in the light of local conditions. However, it is recommended that for canals the terms "right" and "left" should be defined as meaning to the right and to the left respectively of an observer facing in the direction in which the numbers indicated on successive kilometer markings rise.
- 1.1.11 The designations "right-hand side" and the "left-hand side" of the waterway or fairway are to be understood as for an observer facing downstream. On canals, lakes and broad waterways, the terms "right-hand side" and the "left-hand side" shall be defined by the competent authorities.
- 1.1.12 Aid to Navigation (AtoN) means a device, system, or service, external to a vessel, designed and operated to enhance safe and efficient navigation of all vessels and/or vessel traffic.
- 1.1.13 Where the prescribed mark consists of:
- (a) Lights only: the lights may be used both by day and by night;
 - (b) Boards only: the boards may be used as night marks if illuminated;
 - (c) Boards and lights: by day, either boards or lights may be used; by night, either lights or illuminated boards may be used.
- 1.1.14 The marks shall be installed by the competent authorities which:
- (a) Regularly observe the state of the river bed and the changes taking place in it and, on the basis of the results of these observations, correct the positioning of the signs and marks and, where necessary, add to them so that they indicate the fairway dimensions;
 - (b) Regularly measure the depth and the width of the marked fairway and provide boatmasters with the necessary information concerning minimum fairway depths and widths and the river level regime;
 - (c) Establish the plan for the installation of signs and marks (hereinafter the marking plan) in their respective sectors and establish the type and number of floating signs and bank marks to be used, in terms of the requirements of navigational safety and local conditions;
 - (d) Ensure as far as possible the uninterrupted operation of all floating signs and bank marks;
 - (e) Inform boatmasters in good time of the date of the installation and removal of signs, of all alterations of importance to navigation to their number, type, positioning and lighting, and the rules they establish permitting the passage of vessels in restricted sections where meeting and passing are prohibited.
- 1.1.15 The numbering of the sketches of signal signs and marks including lights corresponds to numbering given in annexes 7 and 8 of CEVNI.

1.2 Lights

- 1.2.1 For the purpose of SIGNI and CEVNI, the following definitions are used:
- “Light”: a distinctive light used as a marking.
 - “Fixed light”: an uninterrupted light of constant intensity and colour.
 - “Rhythmic light”: a signal light that shows intermittently with a regular periodicity. The rhythmic character of such a light is the sequence of different appearances presented by the light during a period.
- 1.2.2 In principle, the use of rhythmic lights shall be reserved for the marking of the waterway. Rhythmic lights are described in appendix 4. Rhythmic lights shall also be used under the conditions specified in sections 3.2-3.4 and chapter 4.
- 1.2.3 In principle, the use of fixed lights shall be reserved for purposes other than those referred to in 1.2.2. For the meanings of the fixed lights recommended, see 5.2.2.
- 1.2.4 The luminous intensity of lights is established by the competent authorities in terms of local navigational conditions. In classifying the luminous intensity, it is recommended to use the classification of luminous intensity in appendix 2, which also includes calculations for luminous range.
- 1.2.5 In principle, the colours of lights should be in keeping with the standard of the International Commission on Illumination (CIE) (“Colours of Light Signals”, CIE S 004/E-2001, class A).

1.3 Boards and buoys

- 1.3.1 The recommended shape for boards bearing special signs is rectangular.
These boards are divided into two categories according to the signs they bear:
- (a) Signs giving instructions: these shall be coloured white and bordered in red and display black symbols. Where they indicate a prohibition, the boards shall also bear a diagonal red bar;
 - (b) Signs giving information or indicating the end of an instruction for vessels proceeding in one direction only: all boards shall be rectangular and blue in colour, with white symbols.
- 1.3.2 The visibility of the boards may be improved by a narrow white border.
- 1.3.3 If necessary, these signs may be supplemented by additional boards, indicator plates, inscriptions referred to in 3.5.2 or additional luminous signals referred to in 5.4.
- 1.3.4 The chromaticity of the surface coatings of buoys and boards should lie within the chromaticity areas defined in the recommendations on the surface colours of visual signs and signals published by CIE (see 1.2.5). The back of the panel, if visible from the navigable zone, shall be of such a colour as not to be misleading.

1.4 Geographical limits of applicability of the marking system recommended

- 1.4.1 The competent authorities shall if necessary determine the boundaries between inland waterways (to which the recommended marking system applies) and maritime waterways.
- 1.4.2 The principles of the Aids to Navigation system of the International Association of Marine Aids to Navigation and Lighthouse Authorities (IALA) have been taken, where applicable to inland waterways, as the basis for the following provisions. These provisions have been defined in such a way as to avoid, as far as possible, any risk of conflict or confusion between the two systems of buoyage.



Chapter 2 - Visibility of signs and lights

2.1 General provisions

- 2.1.1 Whatever the position of the vessel in relation to the sign or the marker light, the characteristics of the sign or light shall remain unchanged. For daytime signs, these characteristics are: the form (topmark) and the colour; for signs at night: the type and colour of the lights.
- 2.1.2 The forms and the colours of the topmarks and the types and colours of the lights are set out in detail in sections 3.2-3.4 and their minimal dimensions are set out in appendix 1.
- 2.1.3 The basic requirement to be met by signs and marking is the guarantee of good visibility of all signs and lights by day and by night.
- 2.1.4 In accordance with the recommendations of IALA,¹ there are three degrees of visibility of signs:
- (a) First: the sign is visible to the naked eye. The meaning of the sign is not yet identifiable (simply visible);
 - (b) Second: when the sign is clearly visible and identifiable according to the present provisions and in CEVNI (identifiable);
 - (c) Third: the sign is identifiable and distinguishable from its surrounding background (conspicuous).

Signs that must be seen by a boatmaster at some imperative distance (“no entry”, “keep a particular sharp lookout”, etc.) must have a visibility (due to their proper dimensions) of second or third degree. The type and dimensions of signs should be selected accordingly.

Third degree visibility is required when the sign or light is identifiable in principle, but cannot be easily seen at night owing to the surrounding background (presence of construction or a large number of light sources).

- 2.1.5 The degree of visibility of signs and lights depends on the following conditions:
- Signs:
 - Angle of sight;
 - Colour contrast and differences;
 - Lighting (including natural day light) and weather conditions.
 - Lights:
 - Luminous intensity;
 - Competing lights and background lighting;
 - Weather conditions.

2.2 Conditions of visibility and dimensions of signs

- 2.2.1 In order to ensure the first degree visibility, in daytime the sign shall be visible with an angle of more than 1' (angular minute) and with sufficient contrast in relation to the environment. Detailed form and colour of the sign (second and third degree visibility) can only be distinguished with a larger angle of sight or with a reduction in the distance L to the object being observed.

¹ IALA Guideline No. 1094 — On Daymarks for Aids to Navigation, Edition 1, December 2012.

2.2.2 The minimal angle of distinction in daytime for simple shapes (cylinder, cone, sphere, etc.) is between 3 and 5 angular minutes, and for complex shapes (numbers, letters, etc.) between 5 and 8 angular minutes. For the boatmaster to be able to recognize the daymark (without any optical aids) at appropriate distances and visibility, the following formula can be used for the calculation of the required minimum dimensions of simple and complex shapes (see figure 2.1):

$$H = L \cdot \operatorname{tg} \alpha \cong L \cdot \sin \alpha,$$

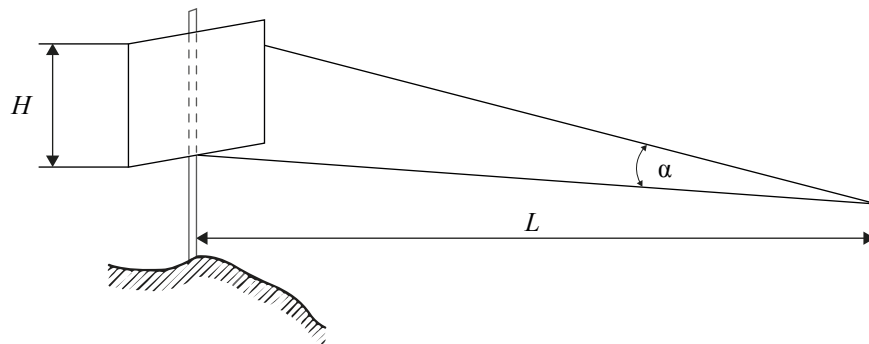
where:

H (m) — height of the sign;

L (m) — distance to the sign;

α (') — viewing angle.

Figure 2.1



Values for H (m) as a function of L (m) and α (') are presented in table 2.1.

Table 2.1

	α (')	500	1 000	2 000	3 000	4 000
For signs of simple shapes (cylinder, cone, circle, etc.)	3	0.44	0.87	1.74	2.61	2.48
	4	0.58	1.16	2.32	3.48	4.64
	5	0.73	1.45	2.90	4.35	5.80

Table 2.1 shows that a shape of a sign with dimension $H = 0.5$ m is recognizable at distance $L = 500$ m and viewing angle $\alpha = 4'$; when $L = 1,000$ m, then $H = 1$ m, etc.

When there are simple drawings (dot, line, arrow) on the signs, a 15 per cent visibility reduction must be taken into account, while with complex drawings it shall be 30 per cent.

2.2.3 Examples of the minimum measurements for the signs, marks and buoys from sections 3.2-3.5 as well as annexes 7 and 8 to CEVNI are given in appendix 1. Alphanumeric characters on signs should intend to provide a standard for the various signs.

The letters, figures and analogous symbols should be of a height not less than one five-hundredth of the maximum distance from which they must be read, and the thickness of the stroke should be not less than one-seventh of that height.

For bank marks and signs, the minimal height from the lower rim of the board down to the base of the lowest sign shall be 3 m. In places where it is necessary due to the configuration of the terrain (relief), a height of 2 m is allowed. At highest navigation water levels, the height between the water surface and the lower rim of the board of the lowest sign should not be less than 1.5 m.

- 2.2.4 As regards the signs and signals of sections 3.2-3.5 as well as of annex 8 to CEVNI, unlighted buoys and unlighted bank mark boards shall be covered with reflective material. Light buoys and lighted bank mark boards may also be so covered. The colours of these materials shall correspond to those established for the buoy lights or the boards. In all cases, the topmarks of light buoys shall be covered with reflective paint.
- 2.2.5 In order to ensure that bank marks are clearly visible, their dimensions shall be determined in terms of their purpose, the distance between the fairway and the banks, the nature of the region and the characteristics or other specific conditions of the sector in question.
- 2.2.6 The good visibility of a sign or signal depends on the contrast between the luminance of the sign or signal and the background. This shall be taken into consideration in choosing a site for signs. For example, of two boards, one red and the other white positioned one beside the other against a light background, the red board will be more visible and visible at a greater distance than the white board while, in contrast, the white board will be easier to see than the red board against a dark background.
- 2.2.7 The visibility of signs in appendix 1 as well as annex 7 to CEVNI regulating navigation on the waterway shall be ensured at night by lighting them with fixed directional white lights, operating uninterruptedly and so positioned that the light does not incommode the boatmasters.
- If electric lighting cannot be used, the sign boards shall be covered with reflective material of a corresponding colour on which the symbol shall be clearly visible to vessels.
- 2.2.8 In order to guarantee the visibility of lighted boards, the back lighting must conform with the provisions of appendix 5, where, in addition to luminance and its regularity, the colour for the white light source is established to ensure that colours under artificial light look the same as when seen in daylight.
- For reliable identification at night the surface of the sign must be smooth and even, and if possible reflective.

2.3 Conditions for the visibility of lights and lighting

- 2.3.1 In certain cases, lighting may be provided at night (e.g. lighting of the lower part of a bridge, of the piers of a bridge, of the approaches to a lock, of a section of a canal, etc.). Such lighting may be used to supplement the markings. Lighting shall be so designed as to avoid dazzling.
- 2.3.2 Luminous intensity is broken down into three categories in terms of navigation lights for inland waterway vessels (see appendix 2).
- 2.3.3 Light signals are identified according to their characteristics. The characteristics are given by their colour and the rhythmicity of the light source in accordance with chapter 5 and appendices 2 and 4.

2.4 Obligation not to hinder road and rail traffic

- 2.4.1 Signs and marking shall be installed in such a way that their lights do not hinder the movements of other modes of transport if the road runs close to the river.
- 2.4.2 In a sector in which a road or a railway runs close to a river, the installation of all the above-mentioned signs and signals shall be carried out in consultation with the respective competent authorities.



Chapter 3 - Buoyage and marking of the waterway

3.1 Requirements to be met by signs and marks and their marking plan

3.1.1 The marking shall be in operation continuously (by day and by night) all along the navigable section of the river, and, as far as possible, as from when the waterway is free from ice until the ice appears; it shall be corrected as changes occur in the water level and in the fairway.

In accordance with the state of the fairway, the marking shall be positioned in such a way that the vessels navigating downstream can use the part of the river with the high current speed and the vessels navigating upstream can use the part of the river with the low current speed.

3.1.2 During periods of high water and icing, the regular floating signs removed to preserve it from possible damage shall be replaced, as far as possible, by marker posts and spars, the topmarks and colours of which shall correspond to those adopted for the respective side of the fairway.

3.1.3 Floating signs shall be installed so as to ensure the safety of vessels on the fairway. Floating signs are anchored at approximately 5 m distance from the limits that they indicate.

3.1.4 Groynes and shallows can be marked using fixed marks or buoys. These marks or buoys are usually placed on the borders of groynes and shallows or in front of them.

3.1.5 Buoys shall be unsinkable and shall remain unsinkable in all storms, and their main body shall therefore be watertight; they shall not only float but also be stable, i.e. conserve a vertical position as far as possible and not be tipped excessively by waves and wind.

3.1.6 The basic condition which the marking plan shall meet is to ensure the safety of the vessels and the continuity of traffic, by day and by night, throughout the sailing season and to give boatmasters clear and unambiguous indications concerning the direction and the limits of the fairway.

3.1.7 The marking plan shall be prepared in such a way as to permit a rational combination of bank marks and floating signs. When the plan is drawn up, it should be based on the conditions of navigation and specific hydrographic and hydro-meteorological conditions, the need to ensure the established dimensions of the fairway and create the necessary conditions for the safety and continuity of navigation of all river vessels and, where necessary, of seagoing vessels.

3.1.8 Bank marks serve to guide boatmasters and to indicate the direction of the fairway. Floating signs supplement bank marks in sectors where, in order to ensure the safety of navigation, it is essential to indicate not only the direction of the fairway but also its limits, and to mark places where there are obstacles.

3.1.9 In preparing the marking plan, the following requirements should be taken into account:

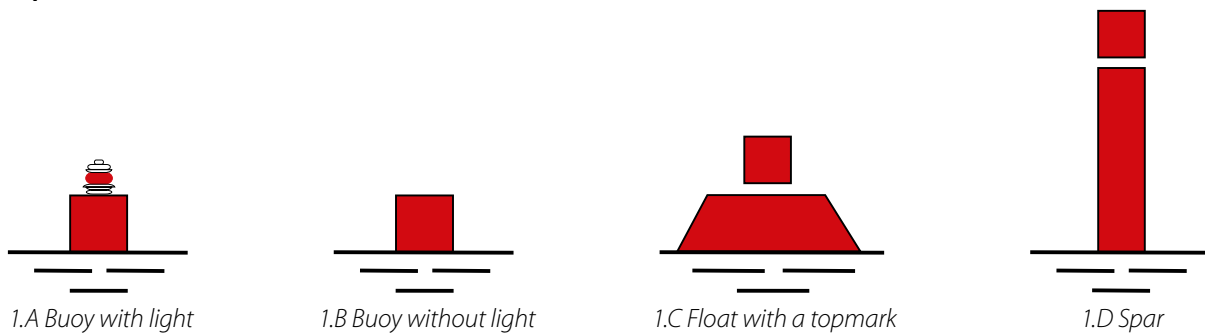
- (a) Only the signs set out in sections 3.2-3.5, as well as annexes 7 and 8 to CEVNI are to be used to mark the fairway and regulate navigation; in exceptional cases, special additional bank marks may also be used, provided, however, that the marks are not in contradiction with those contained in CEVNI;
- (b) The dimensions of the marked fairway shall correspond to the dimensions published by the competent authorities;
- (c) The choice of where the signs are to be placed shall be based on the most recent measurements, acquired experience and available data on the state of the fairway, critical points, water levels, etc.;
- (d) Signs and marker lights shall be visible, whatever the level of the water, at all points of the fairway and as long as may be necessary for the guidance of boatmasters;
- (e) The marking plan shall contain information on the type of placed signs, bank/side whereon placed, river kilometre of the set-up and recapitulation of all floating signs and bank marks used for marking.

- 3.1.10 If there is a subsequent drop in the level of the water, reconnaissance soundings shall be taken on some sections of the river in order to check whether the positioning of the signs is adequate and to establish whether the marking needs to be supplemented by new signs.
- 3.1.11 The frequency of these soundings shall be determined by changes in water level. The more rapid the drop in levels, the more frequent the soundings need to be.
- 3.1.12 Examples of the application of the signs are given in figures 3.10, 3.11 and in chapter 6.

3.2 Buoyage of fairway limits in the waterway

3.2.1 Right-hand side of the fairway

Figure 3.1



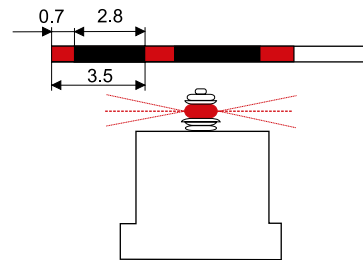
Colour: red

Form: cylindrical buoy or buoy with a topmark, or spar

Topmark (if any): red cylinder

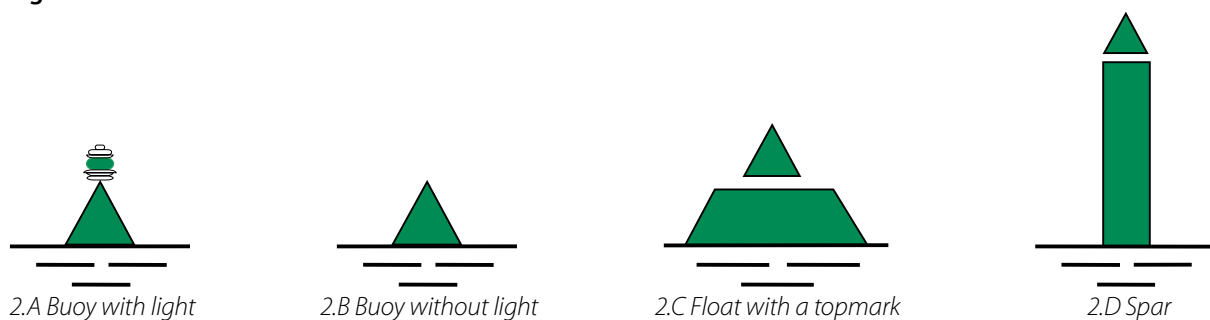
Light (when fitted): rhythmic red light

Generally with radar reflector



3.2.2 Left-hand side of the fairway

Figure 3.2



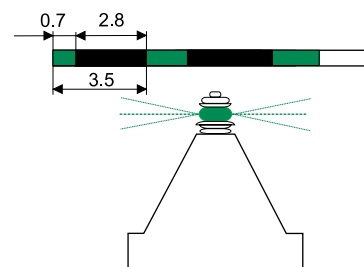
Colour: green

Form: conical buoy or buoy with a topmark, or spar

Topmark (if any): green cone, point upwards

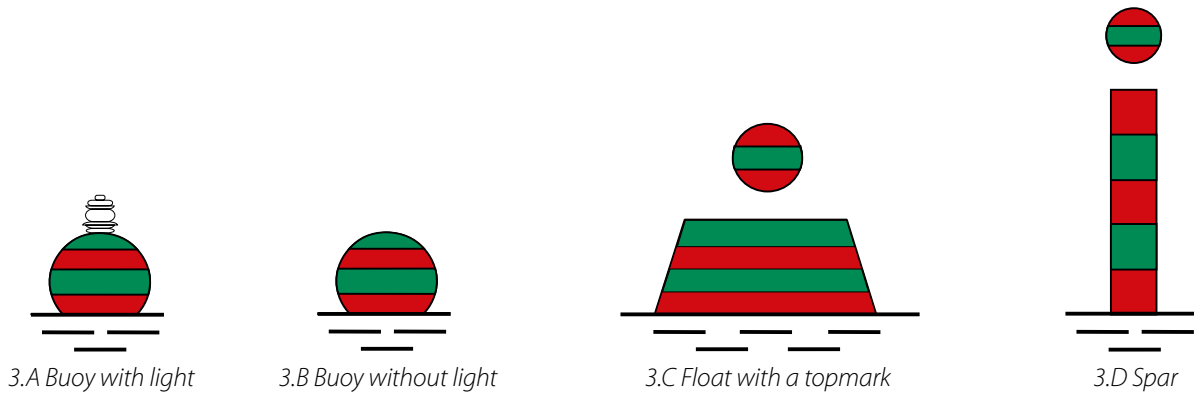
Light (when fitted): rhythmic green light

Generally with radar reflector



3.2.3 Bifurcation of the fairway

Figure 3.3



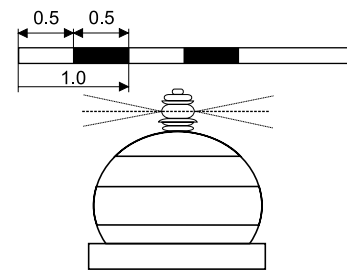
Colour: horizontal red and green bands

Form: spherical buoy or buoy with a topmark, or spar

Topmark (if any): sphere with horizontal red and green bands

Light (when fitted): continuous quick white light, or isophase white light (may be group-flashing white light with a group of three flashes)

Generally with radar reflector



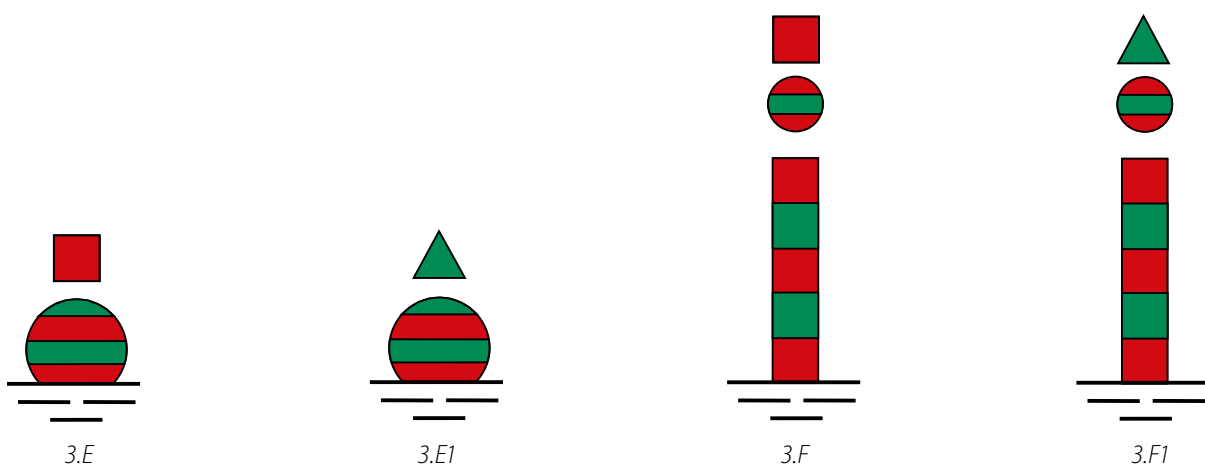
Where there is a risk of confusion with maritime signs and signals or with signs and signals for lakes and broad waterways as defined in chapter 4, the above-mentioned rhythm of light shall not be used and shall be replaced by the group-flashing rhythm (group of three flashes).

When a bifurcation mark is used on lakes and broad waterways, care should be taken to avoid any risk of confusion with the marks provided for in chapter 4.

Where necessary, a red cylindrical topmark or green conical topmark placed above the bifurcation mark indicates on which side it is preferable to pass (main fairway).

The mark shall then bear a rhythmic red light or a rhythmic green light, as appropriate.

Figure 3.4



3.2.4 A letter "P" painted in white on the buoys described in paragraphs 3.2.1 and 3.2.2 indicates that the fairway is adjacent to a berthing area. If the buoys showing the letter "P" carry a light, its rhythm shall be different from that of the lights of other buoys placed along the fairway limit.

3.2.5 The buoyage described above may not be used for the fairways and special zones referred to in chapter 10.

3.3 Buoyage and marking of danger points and obstacles

- 3.3.1 Where it is desired merely to draw attention to an obstacle or danger point without requiring vessels under way to move in a particular direction, the following may be used:
- For obstacles and danger points in the fairway: the buoys, spars, topmarks and lights prescribed in section 3.2 for marking the fairway limits.
 - For obstacles and danger points outside the fairway: either fixed marks (see 3.3.2) or buoys (see 3.3.4) in the waterway.
- 3.3.2 Fixed marks are indicated below.
- Right-hand side

Figure 3.5

Colour: red

Form: post with topmark

Topmark: red cone, point downwards

Light (when fitted): rhythmic red light

- Left-hand side

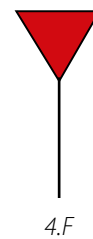


Figure 3.6

Colour: green

Form: post with topmark

Topmark: green cone, point upwards

Light (when fitted): rhythmic green light

- Bifurcation

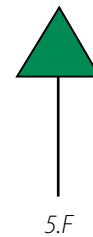


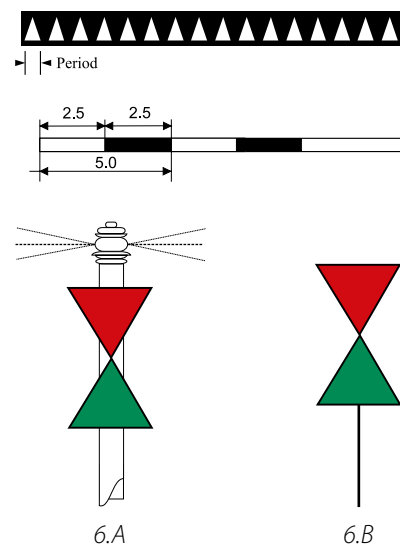
Figure 3.7

Colour: red/green

Form: post with topmark

Topmark: red cone, point downwards, above a green cone, point upwards

Light (when fitted): continuous quick white light or isophase white light (may be the group-flashing white light a group of three flashes)



The above cones may be replaced by triangular panels with a white background and a red or green border.

3.3.3 Secondary arms of the waterway, mouths of waterways and entrances to harbours

On the approach to secondary arms of the waterway, to mouths of waterways and to harbour entrances, the bank walls on both sides of the waterway may be marked as far as the head of the dividing mole by the fixed marks described in 3.3.2, (a) and (b). Vessels entering the harbour are regarded as upstream traffic.

3.3.4 Buoys are described below:

(a) Right-hand side

Figure 3.8

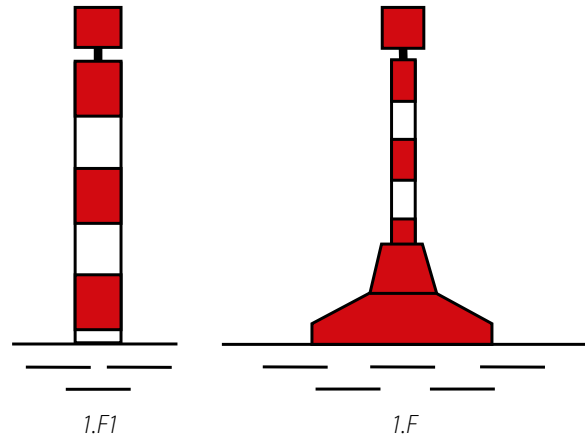
Colour: horizontal red and white bands

Form: spar-buoy or spar

Topmark: red cylinder

Light (when fitted): rhythmic red light

Generally with radar reflector



(b) Left-hand side

Figure 3.9

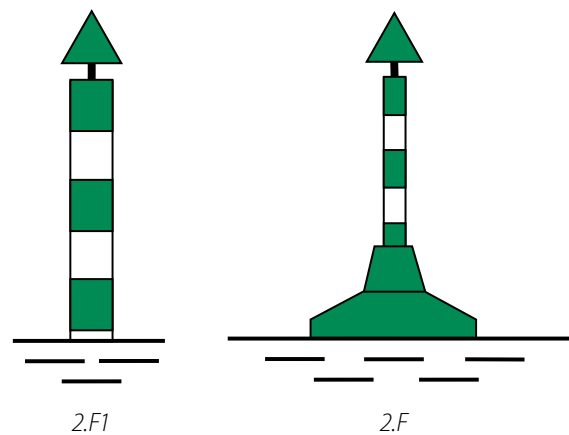
Colour: horizontal green and white bands

Form: spar-buoy or spar

Topmark: green cone, point upwards

Light (when fitted): rhythmic green light

Generally with radar reflector



3.3.5 Examples of using the signs in paragraphs 3.3.2-3.3.4 are given in figures 3.10 and 3.11.

Figure 3.10

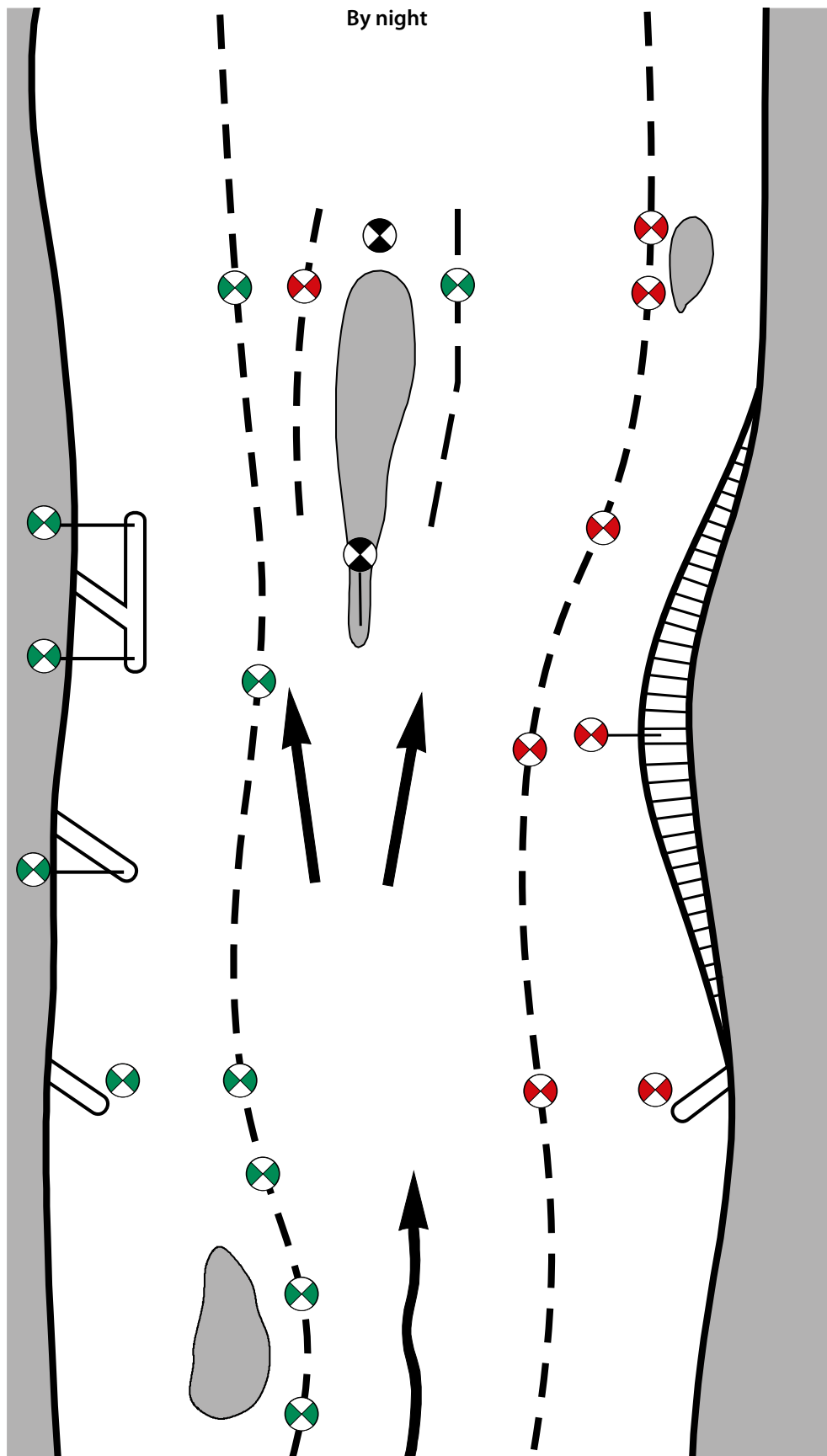
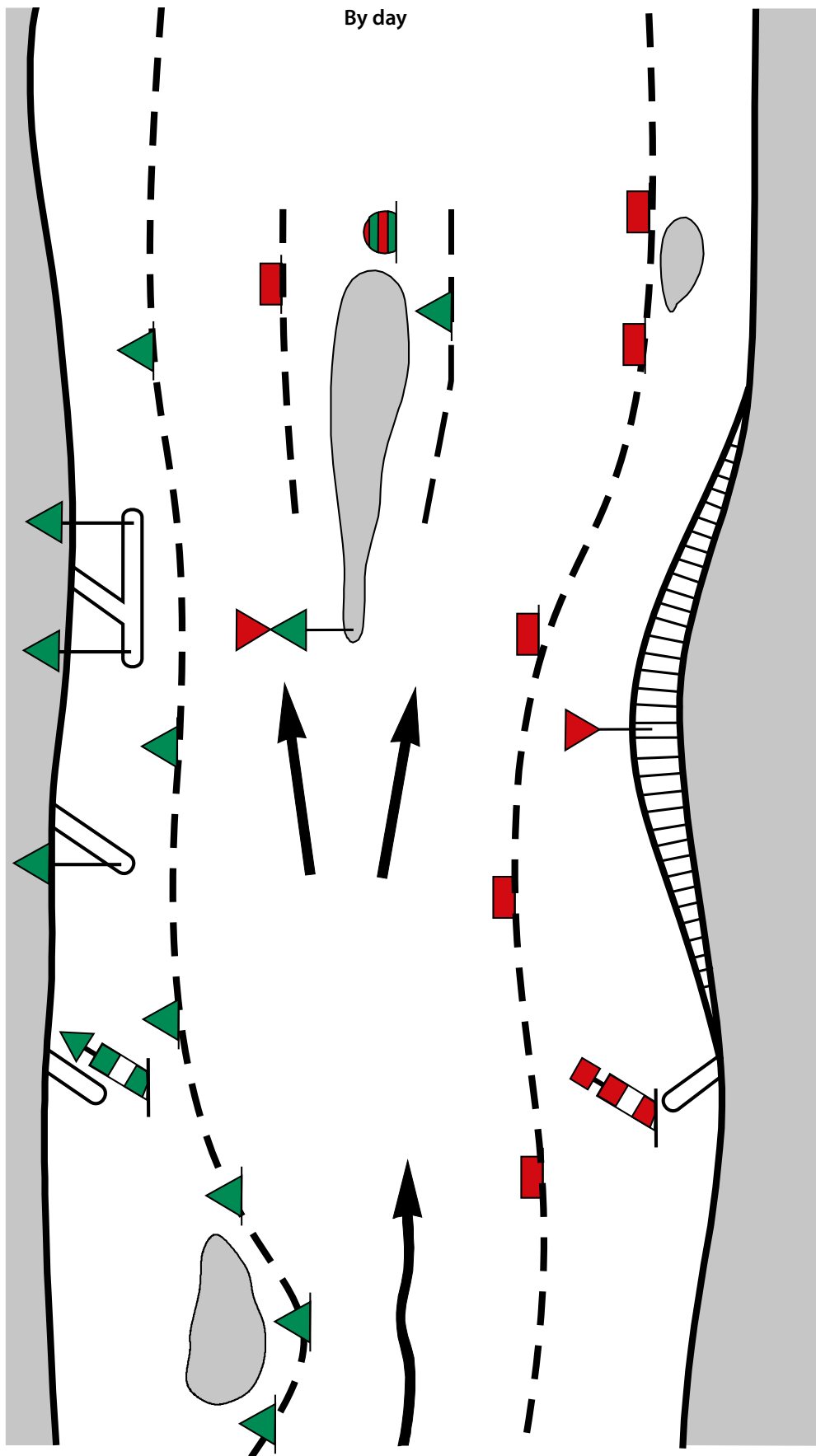


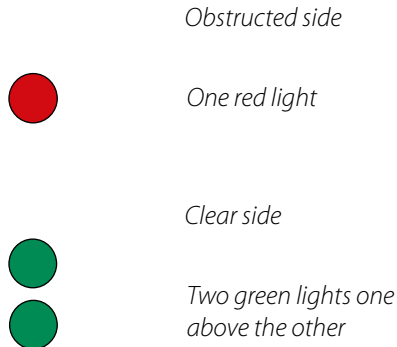
Figure 3.11



3.3.6 Where it is desired to draw attention to the obstacles and danger points and to prescribe only the side on which vessels must pass, the following marking (which may be placed on auxiliary craft) shall be used:
 (a) Passage permitted on the clear side without reducing speed

Figure 3.12

By night



By day

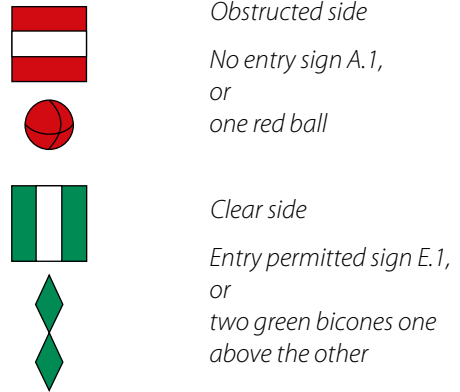
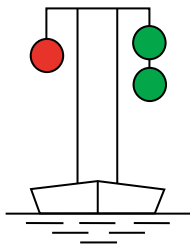


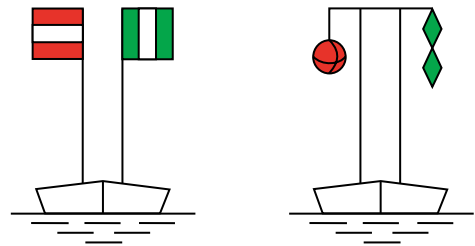
Figure 3.12a

Examples:

By night



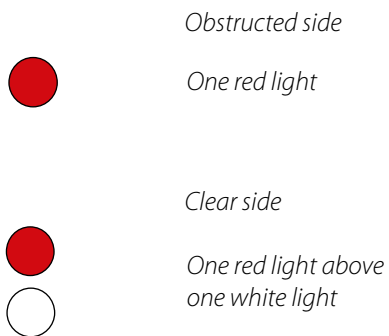
By day



(b) Passage permitted on the clear side at reduced speed (avoid creating wash)

Figure 3.13

By night



By day

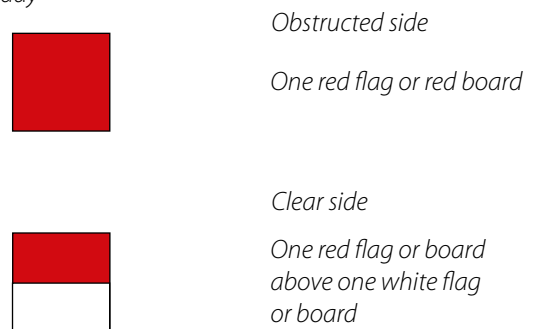
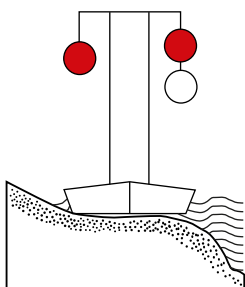


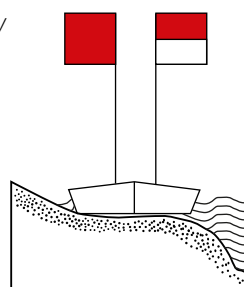
Figure 3.13a

Examples:

By night



By day



3.3.7 Where it is desired both to draw attention to such obstacles and danger points and to require vessels under way to reduce speed in order to avoid causing wash, the flags, boards, balls or lights shown below shall be used; they may be placed whether on the obstacle itself or on an auxiliary craft.

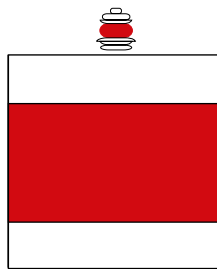
3.4 Bank marks indicating the position of the fairway

3.4.1 Bank marks indicating the position of the fairway in relation to the banks

These signs indicate the position of the fairway in relation to the bank and, together with the buoyage of the waterway, mark the fairway at points where it approaches a bank; they also serve as landmarks.

(a) Fairway near the right bank

Figure 3.14



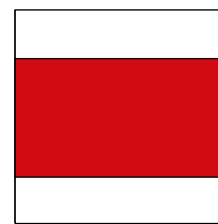
4.A With light

Colour: red/white

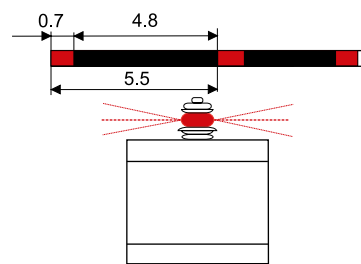
Form: post with topmark

Topmark: square boards (sides horizontal and vertical), red, with two horizontal white stripes

Light (when fitted): rhythmic red light

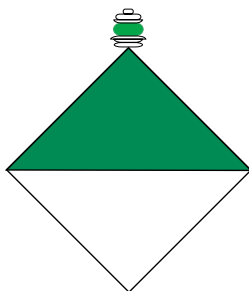


4.B Without light



(b) Fairway near the left bank

Figure 3.15



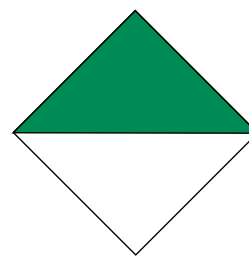
5.A With light

Colour: green/white

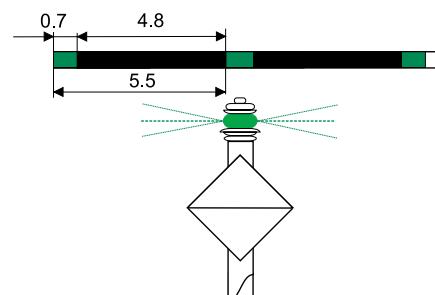
Form: post with topmark

Topmarks: square board (diagonals horizontal and vertical), upper half painted green and lower half white

Light (when fitted): rhythmic green light



5.B Without light

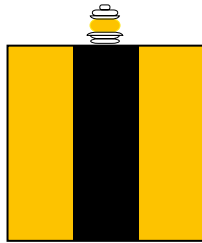


3.4.2 Marking of cross-overs

Marking of cross-overs indicate at what point the fairway passes from one bank to another and also give the axis of this cross-over:

(a) Right bank

Figure 3.16



4.C With light



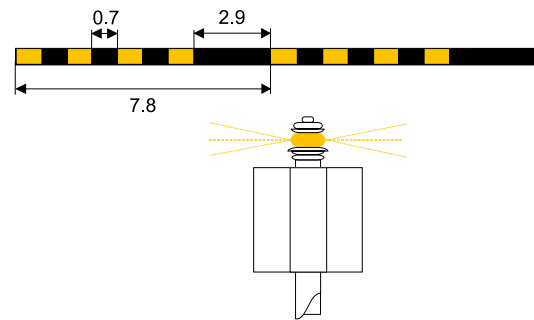
4.D Without light

Colour: yellow/black

Form: post with topmark

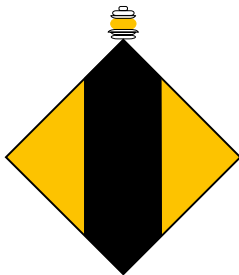
Topmarks: square yellow board (sides horizontal and vertical), with a central vertical black stripe

Light (when fitted): yellow light, flashing or occulting, with an even-number characteristic other than the group-flashing rhythm with a group of two flashes

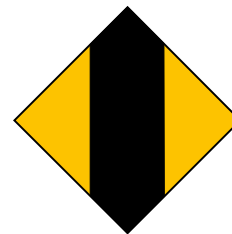


(b) Left bank

Figure 3.17



5.C With light



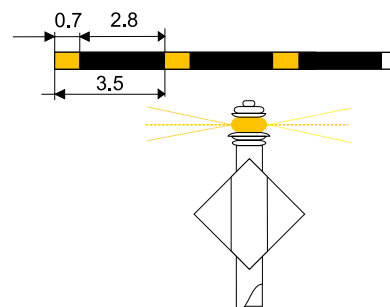
5.D Without light

Colour: yellow/black

Form: post with topmark

Topmark: square yellow board (diagonals horizontal and vertical), with a central vertical black stripe

Light (when fitted): yellow light, flashing or occulting, with an odd-number characteristic other than the group-flashing rhythm with a group of three flashes



3.5 Buoyage and marking of lakes and broad waterways

Main navigation signs

3.5.1 The main navigation signs are given in annex 7 to CEVNI. The signs with their minimal dimensions are given in appendix 1.

Auxiliary navigation signs

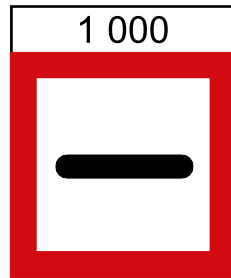
3.5.2 The main signs may be supplemented by the following auxiliary signs:

- (a) Panels showing the distance at which the regulation applies or the special feature indicated by the main sign is to be found

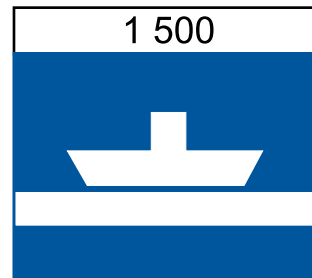
The panels are placed above the main sign.

Figure 3.18

Examples:



In 1,000 m, stop



In 1,500 m, ferry-boat not moving independently

- (b) Additional luminous signal

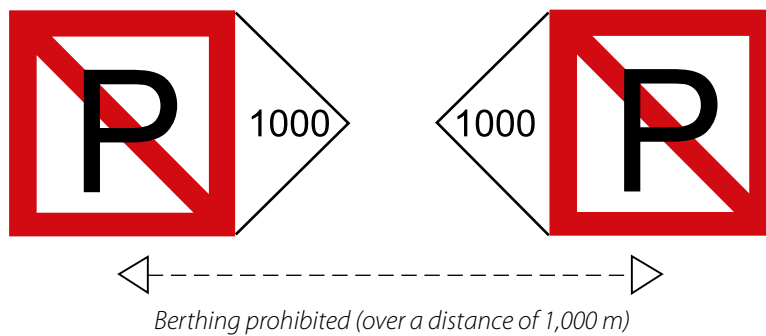
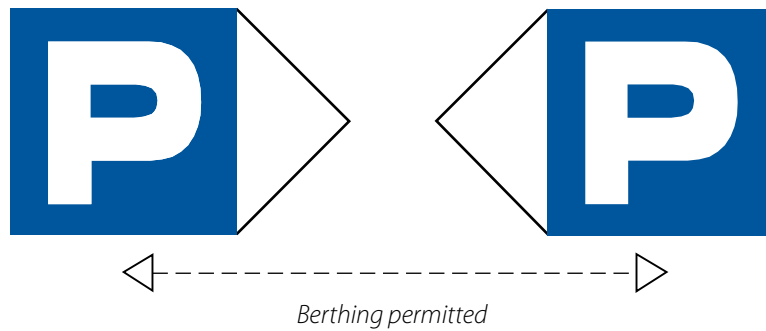
Additional luminous signals are given in section 4.4.

- (c) Pointers showing the direction of the section to which the main sign applies

Note: The pointers need not necessarily be white and may be placed beside or below the main sign.

Figure 3.19

Examples:

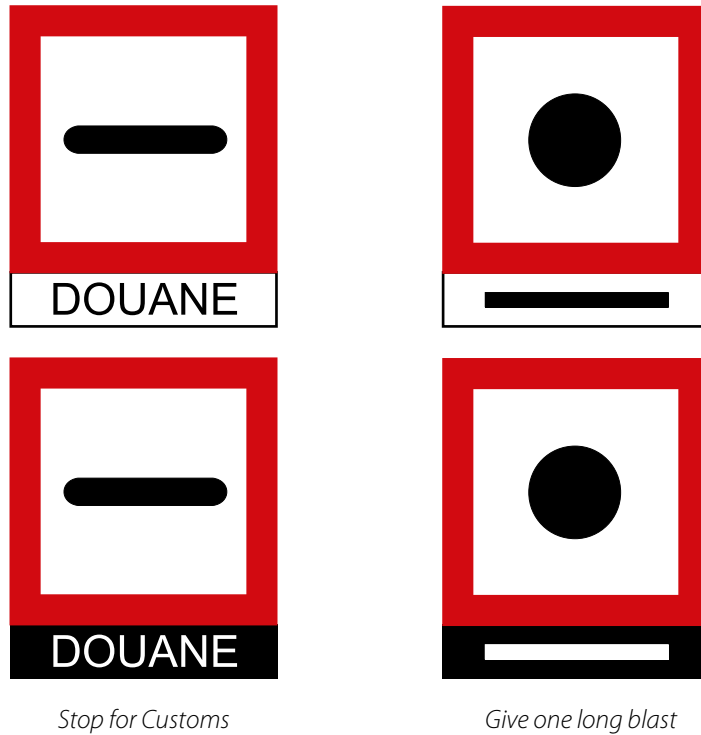


(d) Panels giving explanations or additional information

Note: These panels are placed below the main sign.

Figure 3.20

Examples:

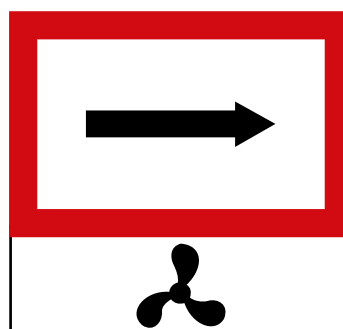


(e) Panels indicating the type of craft concerned

Where a prohibition, a mandatory requirement or an indication applies only to a particular type of craft or activity, the symbol for such craft or activity shall be shown in black on a white ground on a panel below the sign.

Figure 3.21

Example:

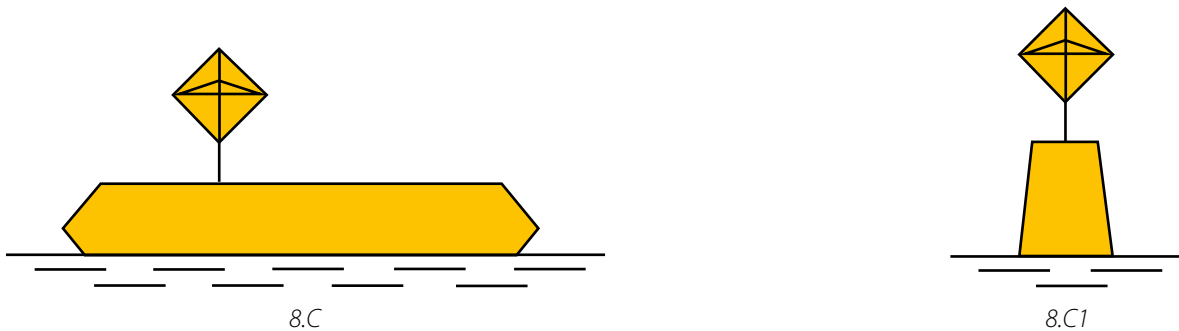


*Mandatory requirement
for motorized craft to take
a specified direction*

3.6 Additional marking for navigation by radar

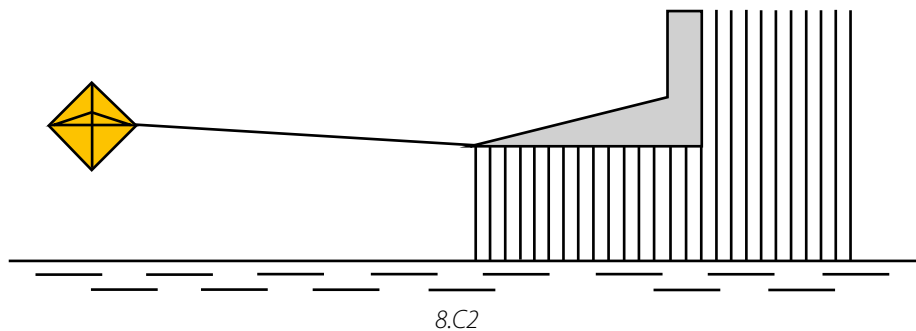
3.6.1 Yellow floats with radar reflectors are placed upstream and downstream from piers.

Figure 3.22



3.6.2 Pole with radar reflector is placed upstream and downstream from bridge piers.

Figure 3.23



3.7 Buoys for miscellaneous purposes

3.7.1 Buoys required for purposes other than those referred to above shall be predominantly white, to avoid confusion with red, green or yellow buoys. They may carry pictograms.

3.8 Warning posts

3.8.1 In special cases where it is necessary to set up warning posts (e.g. on winding sections of waterway where the visual range is limited), the competent authorities shall determine the signals to be given by such posts so far as possible on the basis of the present SIGNI, and in such a way as to avoid confusion or conflict with the signals described in them.



Chapter 4 - Buoyage and marking of lakes and broad waterways

4.1 General

- 4.1.1 Subject to the exception referred to in 3.2.3, the provisions of sections 3.2 to 3.4 shall apply to lakes and broad waterways. However, additional marks, taken from the IALA Aids to Navigation system may be used, if required:
- marking of danger points, obstacles and special features: cardinal marks, isolated danger marks, marking of new dangers;
 - safe water marks;
 - special marks for marking of prohibited or restricted zones;
 - weather signs and signals on lakes.
- 4.1.2 In addition, danger points, obstacles and special features may be marked by other electronic means, such as automatic identification system (AIS).
- 4.1.3 If the competent authorities consider the risk to navigation to be especially high, at least one of the marks should be duplicated. Any duplicate mark shall be identical to its partner in all respects.

4.2 Marking of danger points, obstacles and special features

4.2.1 Cardinal marks

The four quadrants (North, East, South and West) are bounded by the true bearings NW-NE, NE-SE, SE-SW, SW-NW taken from the point of interest.

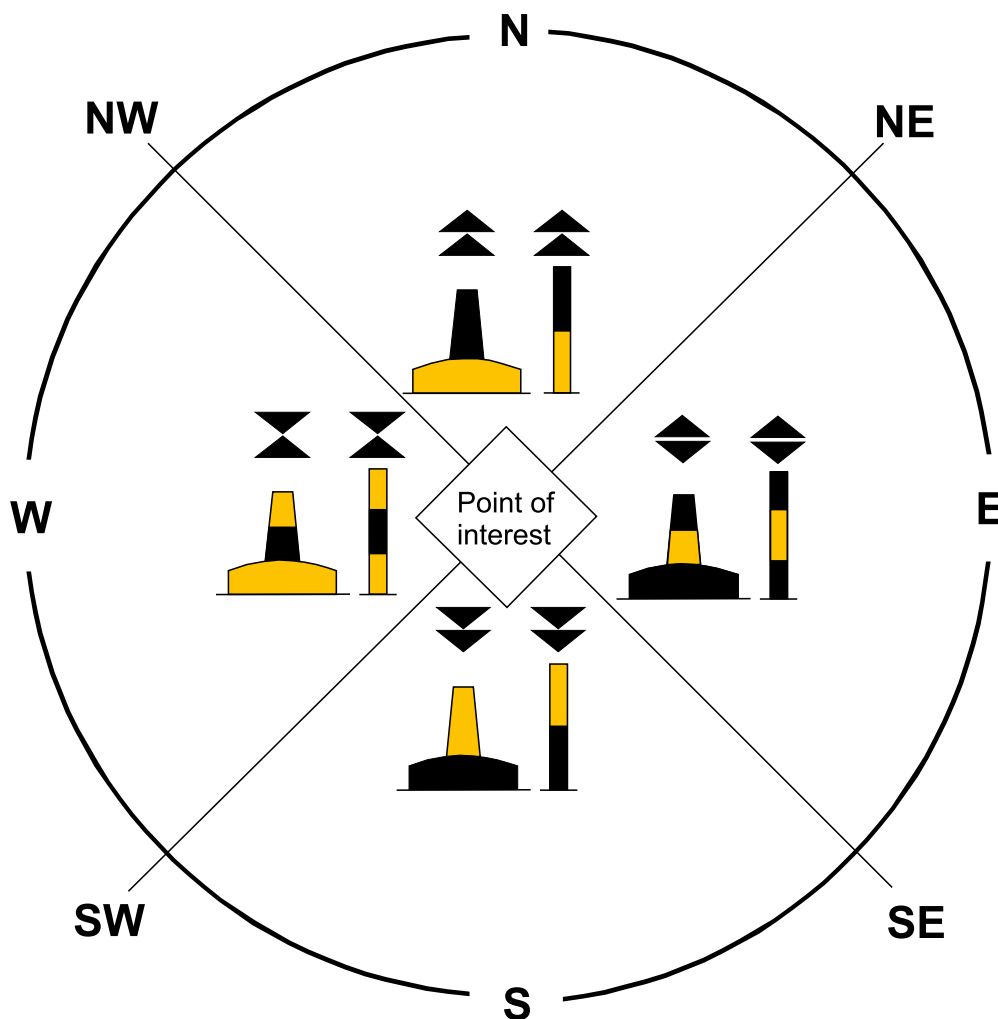
A cardinal mark is named after the quadrant in which it is placed.

The name of a cardinal mark indicates that the mark should be passed on the side of the quadrant named.

A cardinal mark may be used for example:

- to indicate that the deepest water in that area is on the named side of the mark;
- to indicate the safe side on which to pass a danger;
- to draw attention to a particular feature in a fairway such as a bend, a junction, a bifurcation or the extremity of a shoal.

Figure 4.1



North cardinal mark

Topmark: two black cones, one above the other, points upward

Colour: black above yellow

Form: pillar or spar, with topmark

Light (when fitted):

Colour: white

Rhythm: continuous very quick or continuous quick

East cardinal mark

Topmark: two black cones, one above the other, base to base

Colour: black with a single broad horizontal yellow band

Form: pillar or spar, with topmark

Light (when fitted):

Colour: white

Rhythm: group very quick or group quick, with a group of three flashes

South cardinal mark

Topmark: two black cones, one above the other, points downward

Colour: yellow above black

Form: pillar or spar, with topmark

Light (when fitted):

Colour: white

Rhythm: group very quick or group quick, with a group of six flashes followed by a long flash of not less than two seconds duration

West cardinal mark

Topmark: two black cones, one above the other, point to point

Colour: yellow with a single broad horizontal black band

Form: pillar or spar, with topmark

Light (when fitted):

Colour: white

Rhythm: group very quick or group quick, with a group of nine flashes

4.2.2 Isolated danger marks

An isolated danger mark is a mark erected on, or moored above an isolated danger which has safe water all around it.

Figure 4.2

Colour: black with one or more broad horizontal

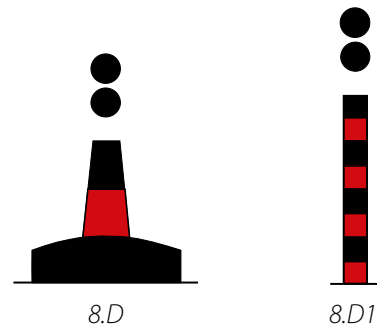
Form: any (generally pillar or spar) with topmark

Topmark: two black spheres, one above the other

Light (when fitted):

Colour: white

Rhythm: group flashing (group of two flashes)



4.2.3 Marking of new dangers

The term "New Danger" is used to describe newly discovered hazards not yet shown in nautical documents. New Dangers include naturally occurring obstructions such as sandbanks or rocks or man-made dangers such as wrecks.

Figure 4.3

Colour: blue and yellow vertical stripes in equal number dimensions (minimum 4 stripes and maximum 8)

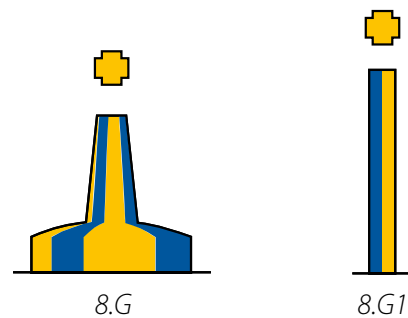
Form: pillar or spar

Topmark (if any): vertical or perpendicular yellow cross

Light (when fitted):

Colour: yellow/blue alternating

Rhythm: one second of blue light and one second of yellow light with 0.5 seconds of darkness between



4.3 Marking of the axis of a channel, the middle of a channel or a landfall

4.3.1 Safe-water marks

Safe water marks serve to indicate that there is navigable water all round the mark; these include centre line marks and mid-fairway marks. Such a mark may also be used as an alternative to a cardinal or lateral mark to indicate a landfall.

Figure 4.4

Colour: red and white vertical stripes

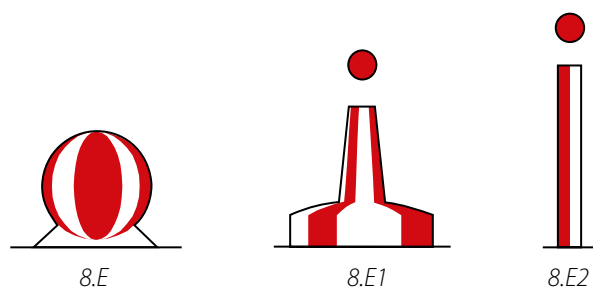
Form: spherical buoy or pillar or spar with topmark

Topmark (if any): single red sphere

Light (when fitted):

Colour: white

Rhythm: isophase, single-occulting, one long flash every 10 seconds or Morse code "A"



4.4 Special marks

Marks not primarily intended to assist navigation but which indicate a special area or feature referred to in appropriate documents, such as military exercise zone marks, recreation zone marks.

Figure 4.5

Colour: yellow

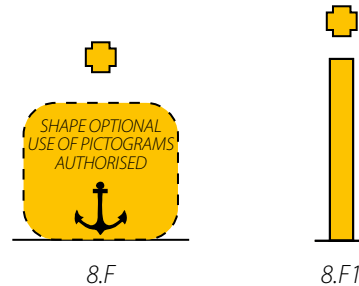
Shape: optional, but not conflicting with navigational marks

Topmark, if any: single yellow, "X" shape

Light (when fitted):

Colour: yellow

Rhythm: any, other than those described in 4.2, 4.3 and 4.5



4.5 Weather signs and signals on lakes

4.5.1 "Caution" warning

A yellow light producing about 40 flashes per minute constitutes a "caution" warning.

The "caution" warning indicates the probable onset of a dangerous phenomenon without specifying the time thereof.

4.5.2 "Imminent danger" warning

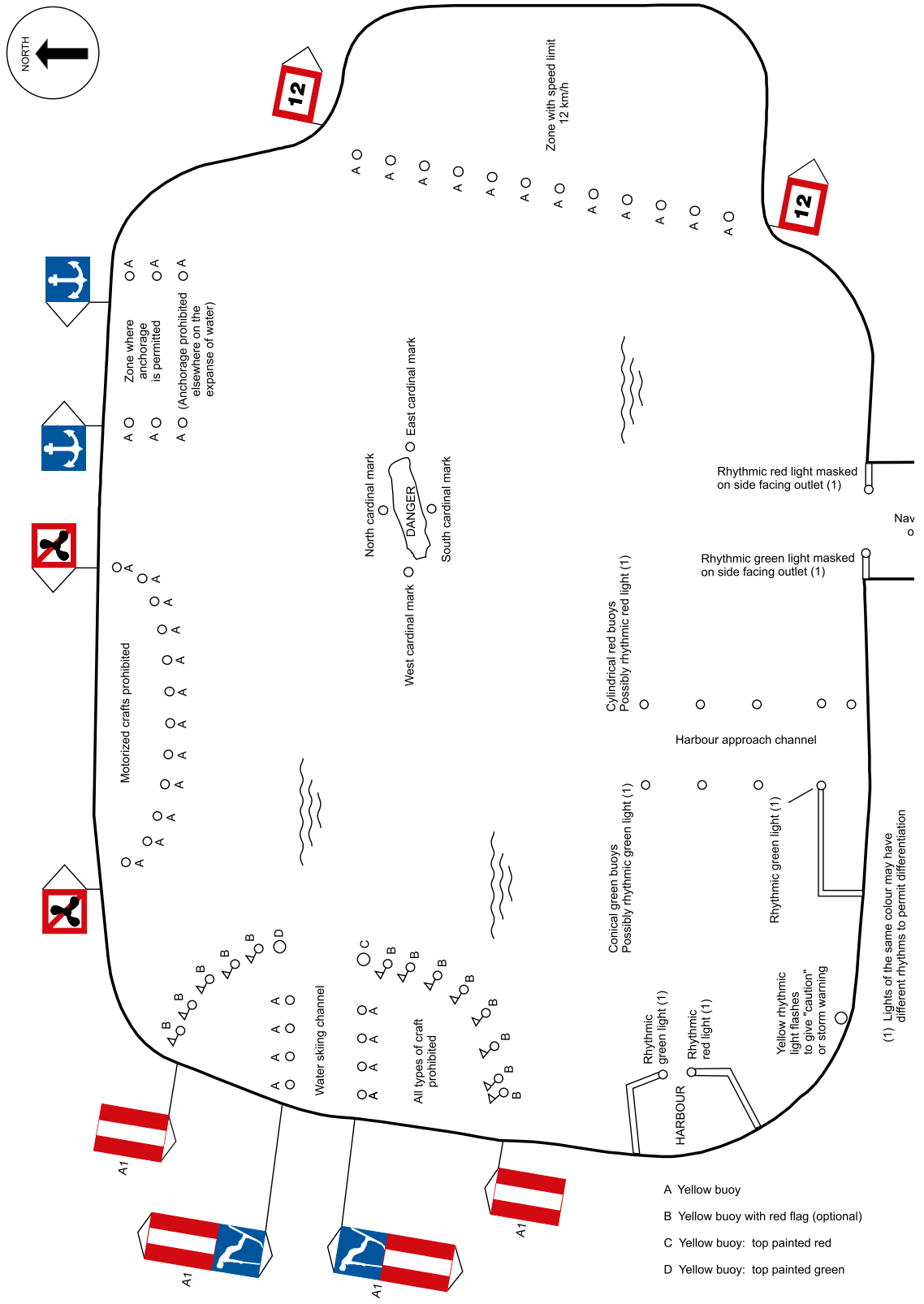
A yellow light producing about 90 flashes per minute constitutes a "danger" warning.

The danger warning indicates the imminent arrival of a dangerous phenomenon.

4.6 Example of signs and signals on lakes and broad waterways

Figure 4.6 illustrates the provisions of this section for lakes and broad waterways.

Figure 4.6





Chapter 5 - Lights

5.1 Definitions

- 5.1.1 The terms “white light”, “red light”, “green light”, “yellow light” and “blue light” mean lights of colours according to the provisions referred to in appendix 2.
- 5.1.2 The terms “quick light” and “very quick light” mean rhythmic lights at a rate of 50-80 flashes per minute and 80-160 flashes per minute.

5.2 Fixed lights

5.2.1 The basic principle of marking by fixed lights is as follows:

- A fixed red light means “Stop”;
- A fixed green light means “Go ahead”.








The meaning of the other marks comprising red or green lights derives from that principle. In particular, a fixed red light combined with other lights means either “Stop” or “Caution”.




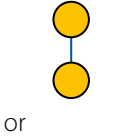

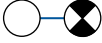

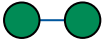
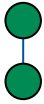




However, since green lights are always placed at the side of the waterway or fairway, vessels must never steer towards a green light. It has therefore been found necessary to provide for another signal authorizing passage towards which vessels may steer: a yellow light.

Pairs of lights should form a visual angle of not less than 5' ($\tan 5' = 0.00145$) to distinguish them from one another.

5.2.2 The meaning of the signals given by fixed lights is given in table 5.1.

Table 5.1

Numbering	Signal	Description	Meaning
A. Prohibitory signs			
A.1c		Single red light	“No passage” In cases where a single red light is not sufficient to clearly indicate the intended prohibition, the use of two or more red lights is recommended
A.1b		Two red lights placed one above the other (a pair)	
A.1d		Two red lights placed side by side (a pair)	
A.11c			Extinction of one of the red lights means: “Passage forbidden (passage about to be authorized)”
A.9b		A red light above a white light	“Do not cause wash”
A.11a		A red light and a green light placed side by side (a pair) or a red light above a green light	“No passage now but stand by to go ahead”. This signal is always operable as required
A.11b	or 		

Numbering	Signal	Description	Meaning
B. Mandatory signs			
B.10		Two isophase yellow lights placed one above the other (a pair)	Vessels proceeding on the main waterway must, if necessary, change course and speed to allow vessels to leave harbours or tributary waterways
D. Recommadatory signs			
D.2b		Two green lights set apart	"Go ahead between the lights"
D.1b		Single yellow light	Recommended opening in both directions. "Go ahead, but look out for traffic coming the other way". Vessels may steer towards the yellow light, which is placed above the navigable fairway
D.1f	 or	A pair of yellow lights (placed one above the other, or, if necessary, side by side), alone or between green lights	Recommended opening only in the direction indicated. "Go ahead; traffic in the opposite direction is prohibited". Vessels may steer towards the yellow lights, which are placed above the fairway
D.1e			
D.3b		A fixed white light and an isophase white light placed side by side (a pair)	"You are recommended to steer in the direction from the fixed light towards the isophase light". Signal to be used, for example, on the approach to a double lock
E. Informative signs			
E.1b		Single green light	"Go ahead" (the green light is always placed at the side of the fairway). In cases where a single green light is not sufficient to clearly indicate the allowed passage, the use of two green lights is recommended
E.1c		Two green lights placed side by side (a pair)	
E.1d		Two green lights placed one above the other (a pair)	
E.12		One or two white lights	"Difficulty ahead — Stop if the regulations so require"
E.12a		Fixed light(s): advance signal	Examples: Lock closed, vessel navigating in the opposite direction
E.12b			
E.12c		Isophase light(s): advance signal	Examples: Lock open, no vessel navigating in the opposite direction
E.12d		"You may proceed"	

Notes: Each fixed red, green or yellow light may be replaced by a red-white-red, a green-white-green or a yellow board respectively, as provided below in chapters 8 and 9.

Single fixed white lights shall not be used except as advance signals. Fixed white lights must be used with care as they may be confused with other white lights (for instance, public lighting).

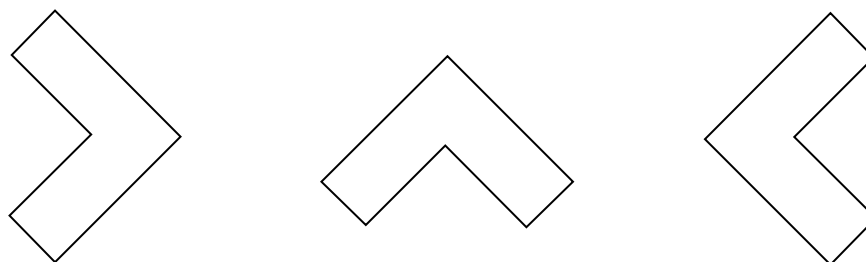
5.3 Rhythmic lights

Rhythmic lights are described in sections 3.2-3.4, chapter 4 and appendix 4.

5.4 Additional luminous signal

Additional luminous signal is a luminous white arrow combined with certain lights from section 5.2. The signal relates to the direction of navigation shown by the arrow.

Figure 5.1



Examples: On a main waterway, at the entrance to a basin, this signal means:

- (a) With green light

Figure 5.2

Permission to enter the basin to which the arrow is pointing

- (b) With red light

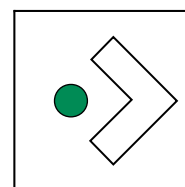
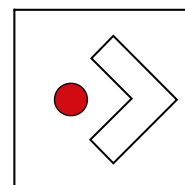


Figure 5.3

No entry to the basin to which the arrow is pointing



5.5 Semaphores

- 5.5.1 In special cases where a semaphore is required to regulate navigation (e.g. in harbours), the competent authorities shall determine the signals to be given by the semaphore in such a way as to avoid any confusion or conflict with the signals described in the present provisions.
- 5.5.2 The competent authorities shall preferably choose a signalling system using red and green lights, operable as required.



Chapter 6 - Installation of signs and marking in characteristic sections of the river

6.1 General

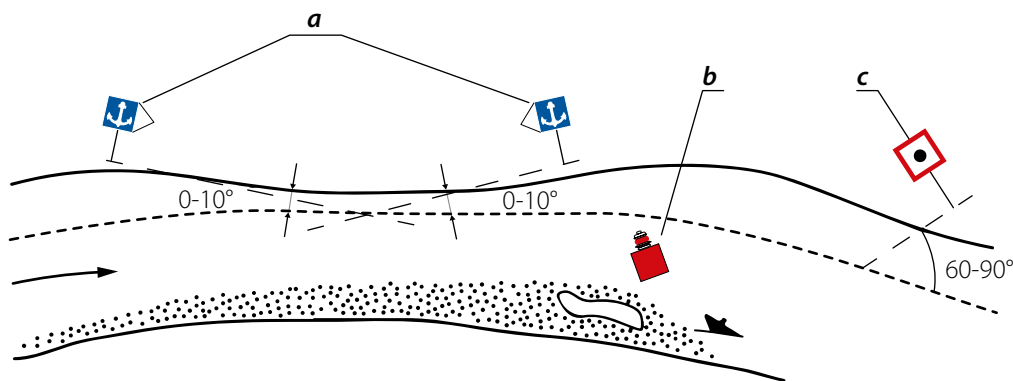
6.1.1 Signs have two possible orientations, namely:

- (a) Parallel to the axis of the fairway;
- (b) Perpendicular to the axis of the fairway.

6.1.2 Signs of the type mentioned under 6.1.1 (a), are predominantly prohibitory or indicative signs, and are placed on the side of the fairway to which the prohibition or the indication applies.

Bank marks which are used in relation to navigation in both directions (upstream and downstream) shall be oriented as under 6.1.1 (a). In some cases, (better visibility) the angle between the mark and the axis of the fairway can be 10° or less (figure 6.1, sign a).

Figure 6.1



6.1.3 Most signs are positioned as described under 6.1.1 (b), and generally do not apply to one side of the fairway only. These signs are erected at right angles to the axis of the fairway so that they are visible to a user when under way.

Bank marks which are used in relation to navigation in one direction (upstream or downstream) shall be oriented as under 6.1.1 (b). In some cases, (better visibility) the angle between the mark and the axis of the fairway cannot be less than 60° (figure 6.1, sign c).

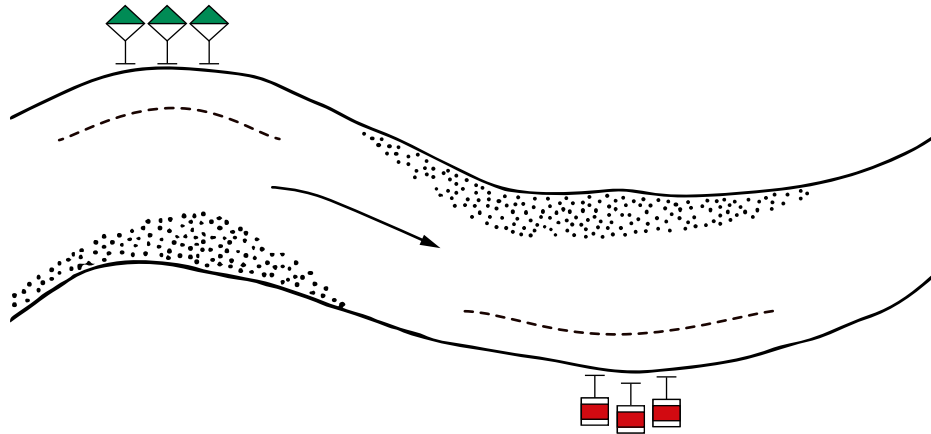
6.1.4 The use of a particular floating sign or bank mark and how it is installed depends on the one hand on the local features of the river (speed of current, variation in levels, meanders, width of the river bed, existence of sills, branches, islands, etc.), and on the other hand on the density of traffic in a given sector and the form and size of convoys.

6.1.5 The position of each floating sign indicating the side of the fairway shall be determined on the basis of the marking plan based on the results of measurements. Depths within the limits of the width of the marked fairway shall under no circumstances be less than the minimum depth reported for the sector in question.

6.1.6 When floating signs are installed, it is essential to take the direction of the current into account. If the current flows in the direction of a navigational hazard (obstacle), the sign or signal shall always be placed a long way from it; if, on the other hand, it flows in the opposite direction, the sign or signal shall be placed nearer.

6.1.7 An example of the installation of the marks indicating the position of the fairway is given in figure 6.2.

Figure 6.2



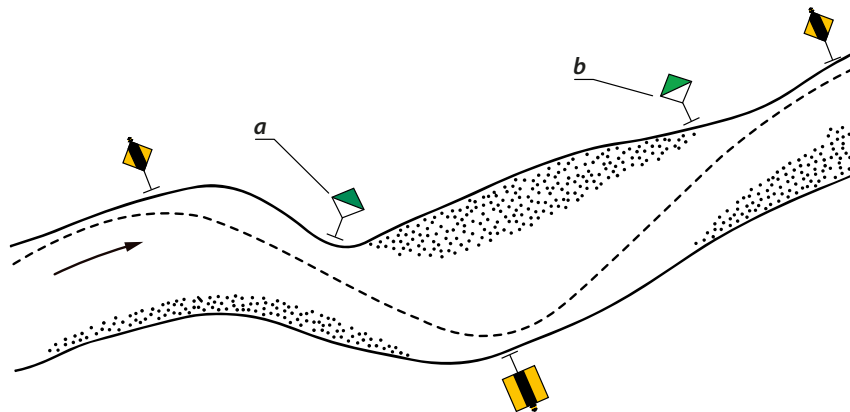
- 6.1.8 Obstacles on the sides of the fairway are always marked with floating signs. When the obstacle is indicated by a single sign, it shall be placed on the upstream extremity of the obstacle, on the fairway side (figure 6.1, sign *b*).
- 6.1.9 As a rule, lighted buoys or unlighted buoys shall be used to mark the upstream and downstream extremities of sills, banks which narrow the fairway in meandering sectors, banks protruding into the fairway, piles of stones, reefs, water supply engineering structures, and underwater hazards or obstacles (sunken vessels, anchors, etc.).
- 6.1.10 Marker posts and spars shall be used as additional signs supplementing buoys in order to give a clearer indication of the limits of the fairway over difficult sills and in order to mark underwater obstacles. In some cases and in some sectors, buoys may be replaced by marker posts or spars.
- 6.1.11 In order to avoid damage to buoys during the period when ice is carried down, they shall be replaced by spars or marker posts.
- 6.1.12 On sectors of the river where there is day and night navigation, forks, junctions and the axis of the fairway, along with obstacles to navigation lying within the fairway, shall be marked by light buoys or bank marks and lights. Floating signs shall be installed at such a depth and at such a distance from the obstacle that the safety and ease of movement of vessels shall be guaranteed at night and in poor visibility.
- 6.1.13 On sectors where the river bed is narrow, preference shall be given to bank marks.
- 6.1.14 Each bank mark shall be established following reconnaissance of the area and selection of the most appropriate site. The need to ensure the visibility of the sign whatever the level of the water should be taken into consideration.
- 6.1.15 Where it is necessary to ensure good visibility of the symbol on the sign over a long distance, both for vessels proceeding upstream and vessels proceeding downstream, two boards may be installed on the sign pole at an angle to each other, one pointing upstream and the other downstream.
- 6.1.16 In selecting the site of bank mark, account shall be taken of the need to ensure easy maintenance and to protect it against ice and flooding.
- 6.1.17 Before a bank sign or signal is installed, the depth in the area in front of it and in the direction it indicates shall always be measured.
- 6.1.18 As a general rule, the objective is that only the network of bank marks shall provide an uninterrupted indication of the position of the fairway as a whole, while the floating signs shall help boatmasters to determine the limits of the fairway.

6.2 Marking of meandering sectors

Installation of cross-over marks and bank lights

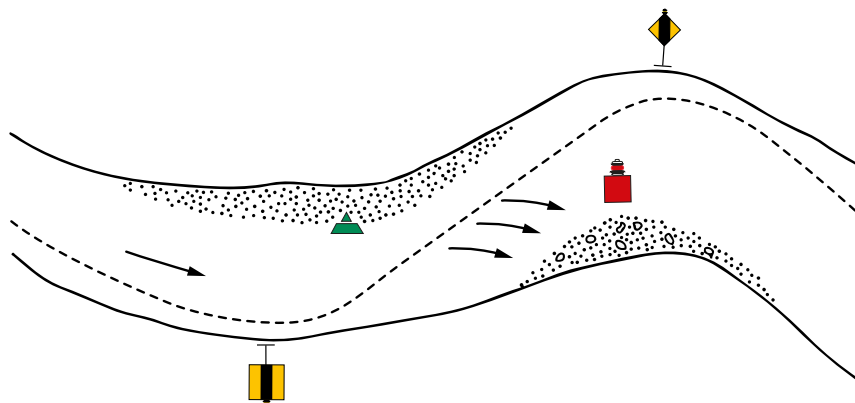
- 6.2.1 Cross-over marks and bank lights may be used in meandering sectors in order to indicate that the fairway crosses over from one bank to the other (signs featured in 4.C, 4.D, 5.C, 5.D in paragraph 3.4.2).
- 6.2.2 Cross-over marks and bank lights are placed when the fairway is sufficiently broad, its safety is ensured, and when the direction only requires to be indicated approximately.
- 6.2.3 Bank lights and cross-over marks shall be selected in such a way as to differentiate cross-overs in terms of their length, in other words in terms of the distance between two neighbouring signs. The length of the cross-over is relative, since it depends on the width of the fairway.
- 6.2.4 Cross-over marks and bank lights have best results on distances up to 3 km. On such sections, cross-over marks and bank lights (without floating signs) can be placed under conditions where the available width for navigation is more than two times wider than the minimum prescribed width of the fairway for a particular sector. If the available width for navigation is less than the minimum prescribed width of the fairway for a particular sector, cross-over marks and bank lights (without floating signs) cannot be placed at distance greater than 1-1.5 km.
- 6.2.5 If the distance between two neighbouring cross-over marks is larger than the calculated visibility, and when the fairway passes close to the bank, the bank mark with light, which additionally marks the position of the fairway, is placed between those two neighbouring cross-over marks (figure 6.3, sign *a*). The bank mark with light is also placed when the fairway passes near the bank (figure 6.3, sign *b*).

Figure 6.3



- 6.2.6 In case the direction of the current makes an angle with the fairway, when strong side winds or a similar situation occurs, the fairway can be marked by additional navigation marks according to the local conditions (figure 6.4).

Figure 6.4

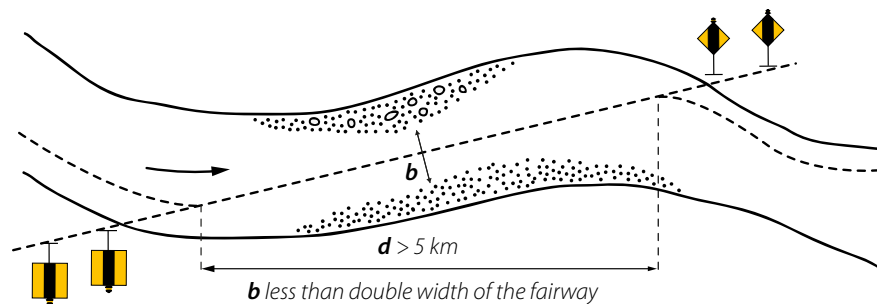


- 6.2.7 When the fairway follows the middle of the river bed over a long distance or when it crosses abruptly from one bank to the other, its axis may be indicated by a pair of cross-over marks on each side of the fairway, as shown in figure 6.5.

The advantage is given to two cross-over marks on each side of the fairway in case of straight-line sections longer than 5 km, where the available width for navigation is less than double the width of the minimum prescribed width of the fairway for a particular sector. In that case and when the bank configuration allows so, the cross-over marks are placed on both margins of the transition (figure 6.5).

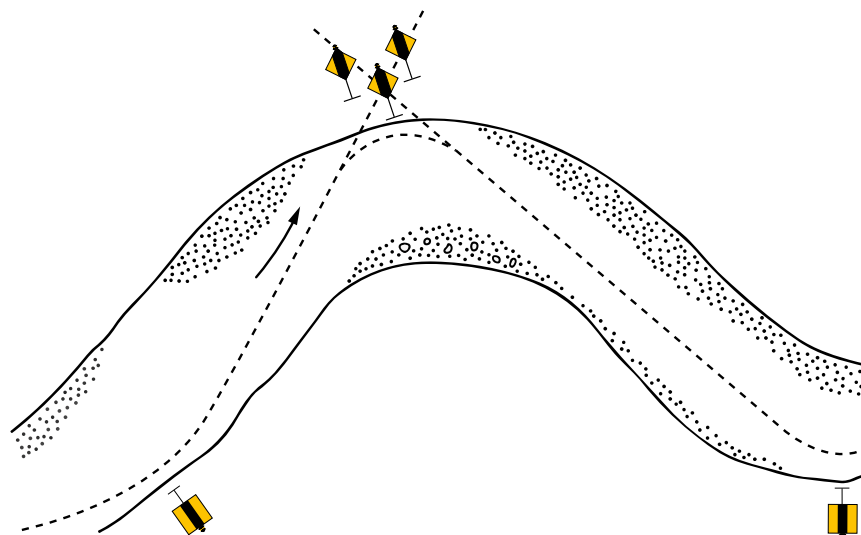
It is always preferable to have two cross-over marks on each side of the fairway when the fairway is narrowed by certain obstacles constituting threats to navigation or other hazards marked by floating signs.

Figure 6.5



- 6.2.8 In sectors where the fairway, after moving to the opposite bank, abruptly crosses to the other bank, three cross-over marks (the front shall have two boards) must be placed (figure 6.6). In this case, lights of the back cross-over marks shall be oriented strictly on the axis of the fairway, one upstream and the other downstream.

Figure 6.6



6.2.9 Interrelationships of the front and back marks at hidden routes shorter than 4 km are presented in table 6.1.

Table 6.1

L (m)	d (m)	h_0 (m)	a (m)	$2a$ (m)
200	17	8.50	2.6	5.0
300	25	8.70	4.0	8.0
400	33	8.85	5.2	10.5
500	42	9.00	6.5	13.0
600	50	9.10	8.0	16.0
700	58	9.20	9.0	18.0
800	67	9.35	10.0	20.0
900	75	9.50	12.0	24.0
1 000	83	9.60	13.0	26.0
1 500	125	10.25	19.0	38.0
2 000	166	10.90	26.0	52.0
2 500	207	11.50	33.0	66.0
3 000	250	12.15	39.0	78.0
3 500	290	12.75	46.0	92.0
4 000	330	13.40	52.0	104.0
> 4 000	760	14.20	25.0	50.0

Where (see figure 6.7):

L (m) — maximal distance when cross-over marks can be used;

d (m) — distance between front and back signs (is approximately $1/12 L$);

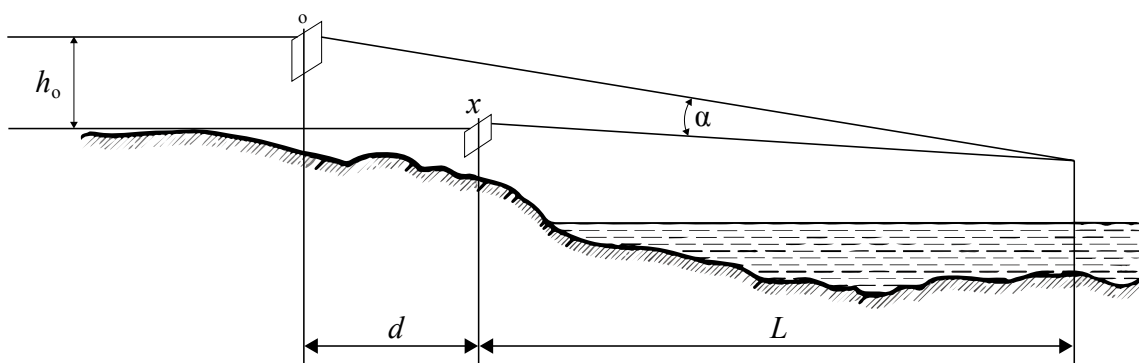
h_0 (m) — height between lights of front and back mark;

a (m) — distance necessary for a vessel to adjust its course if the vessel does not go along the cross-over;

α (°) — viewing angle.

Table 6.1 also assumes that the observer's sight is 5 m above the water level, and the light of the lower (front) sign is 8 m above the water level.

Figure 6.7



Value α describes accuracy of the route and it is of significance while navigating through a narrow fairway. Accuracy is, in principle, increased by approaching the cross-over marks.

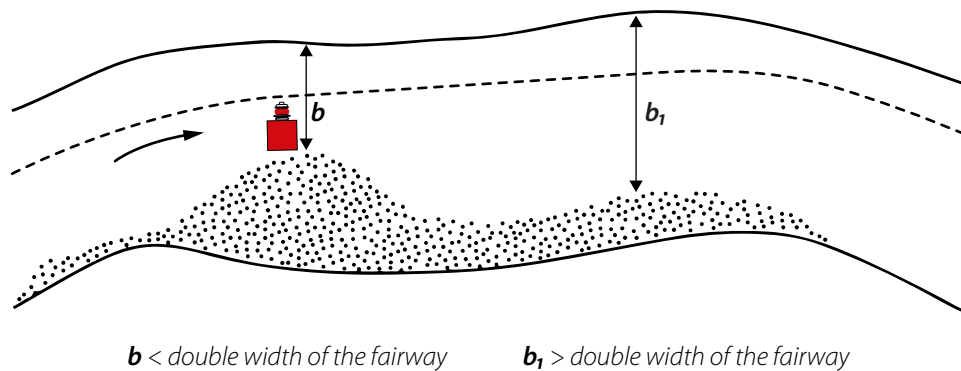
To ensure proper recognition of cross-over marks and their lights, the viewing angle cannot be less than 4 angular minutes in relation to the vertical.

Installation of floating signs

6.2.10 In meandering sectors, where the fairway passes along the middle of the river bed, or along the bank or passes slowly from one bank to the other, floating signs are used to mark formations in the river bed or obstacles, both natural and artificial, on the sides of the fairway (banks, shores, islands, stones, sunken vessels, wrecks of bridges, etc.), when these obstacles protrude into the fairway and reduce its width (figure 6.8).

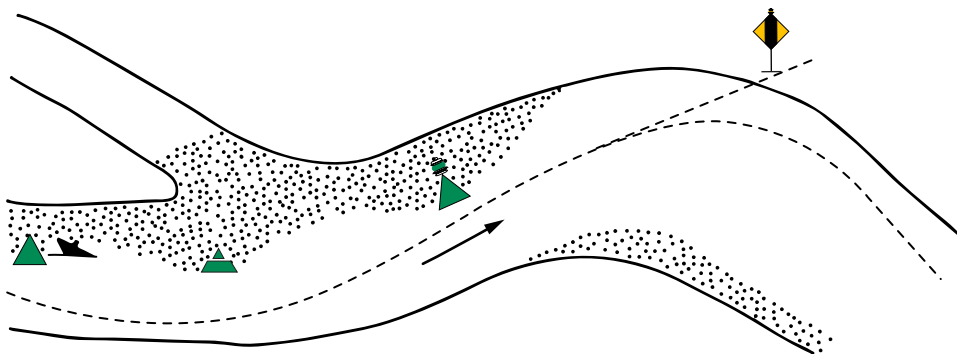
These underwater obstacles are marked in meandering sectors by floating signs if, within the limits of width indicated above, the depth of water over such obstacles does not exceed the minimum depth reported for the sector. If the obstacle is not very wide, a floating sign with light shall be installed on its upstream section. A marker post or a spar may be installed on its downstream section, depending on its length.

Figure 6.8



6.2.11 Floating signs marking underwater obstacles of considerable length are installed in such a way that the parts situated closest to the fairway are marked by light signals between which unlighted signs are placed, thus enabling a given obstacle to be marked completely (figure 6.9).

Figure 6.9



6.2.12 In the parts of the river bed where the shore opposite that followed by the fairway is bordered by an inshore bank which favours upstream navigation in calm water, the bank is marked by floating signs independently of the width of the river bed.

6.2.13 In meandering sectors the bank marking system in periods of high water generally remains the same as in periods of lowest water level, except in sectors where, when water levels are high, it is advisable to find another fairway with better navigational features. In this case, the selected fairway shall be marked appropriately.

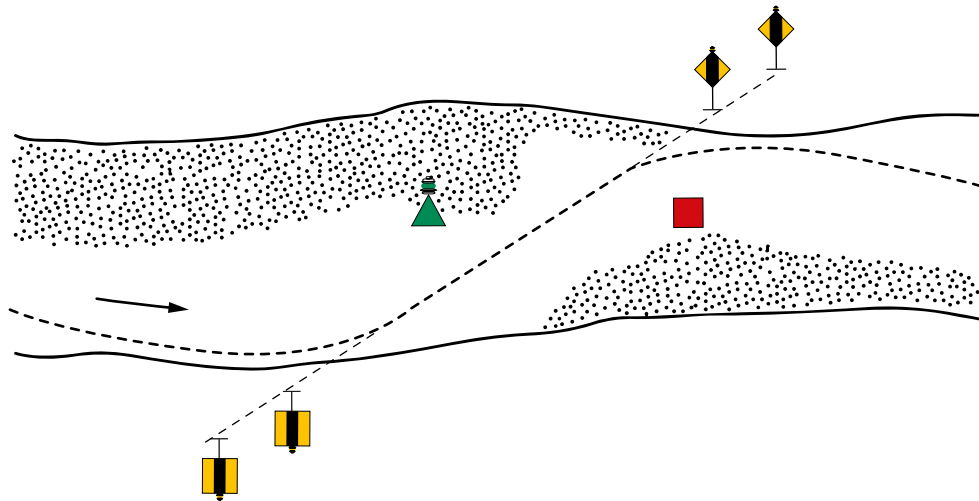
6.3 Marking of shoals

6.3.1 In shoals, as in other sections, the principle of the continuous marking of the direction of the fairway shall be applied.

In shoals the fairway can be marked by cross-over marks, bank marks and floating signs.

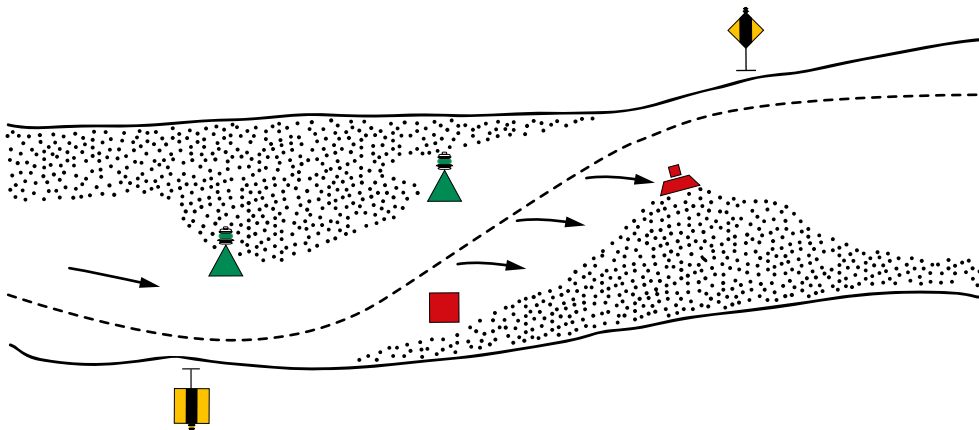
6.3.2 Alternately located shoals may also be marked by cross-over marks, with sufficient available width for navigation in which vessels are passing in a straight line (figure 6.10).

Figure 6.10



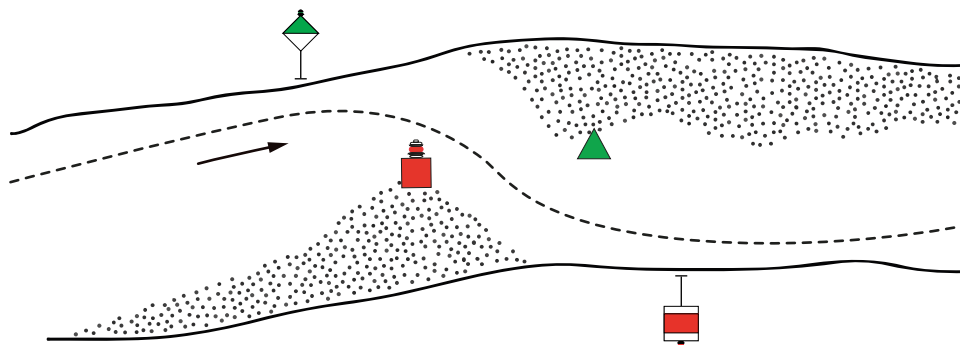
6.3.3 A fairway passing over shoals is usually marked by floating signs (figures 6.10 and 6.11).

Figure 6.11



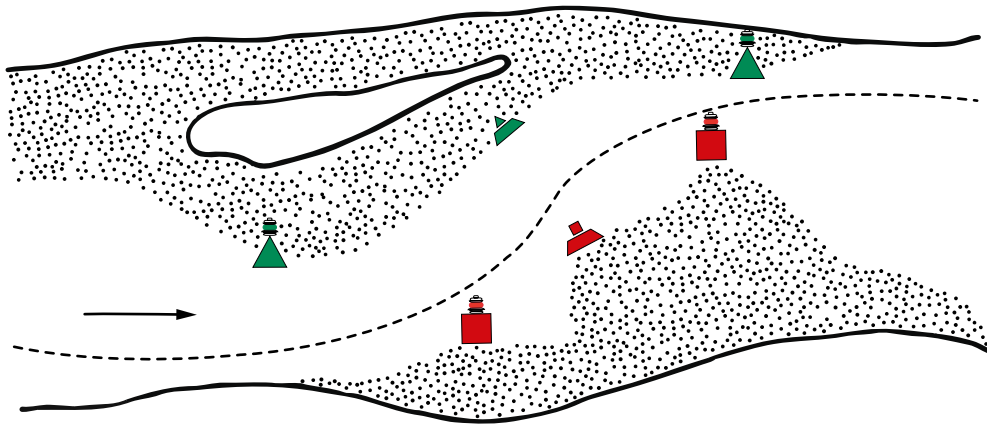
6.3.4 If the fairway passes in a straight line between sandbars, reaching far into the river bed, it is necessary to place at least two floating signs at the entry and the exit of such a section: one at the top of the upstream sandbar and one on the top of the downstream sandbar (figure 6.12).

Figure 6.12



6.3.5 If the fairway is curved in the section between sandbars, it is necessary to place additional floating signs (figure 6.13).

Figure 6.13



6.3.6 Additional floating signs shall also be placed on the entry and exit of rugged sections with sandbars, which also characterize the side streams.

6.3.7 In case the application of cross-over marks is impossible, the fairway across a shoal may be marked only by floating signs, on one or both sides, depending on the width of the fairway and hydrological conditions.

6.4 Marking of the vicinity of bridges and passages through bridges

6.4.1 The navigation of vessels and convoys in the vicinity of bridges and through bridge passages requires particular attention and precautions on the part of boatmasters because of the narrow fairway. These sections must therefore be marked with the greatest care.

6.4.2 The basic condition to be met to ensure safe passage through bridges is the marking of the direction of the fairway and also, where necessary, its sides. Floating signs and bank marks may be used in addition to boards and lights for marking the navigable passage through bridges.

6.4.3 The choice and positioning of the marking signs depends in each case on local conditions in the bridge section.

6.4.4 The installation of marking signs in the vicinity of bridges and the buoing of navigable passages shall comply with the following conditions:

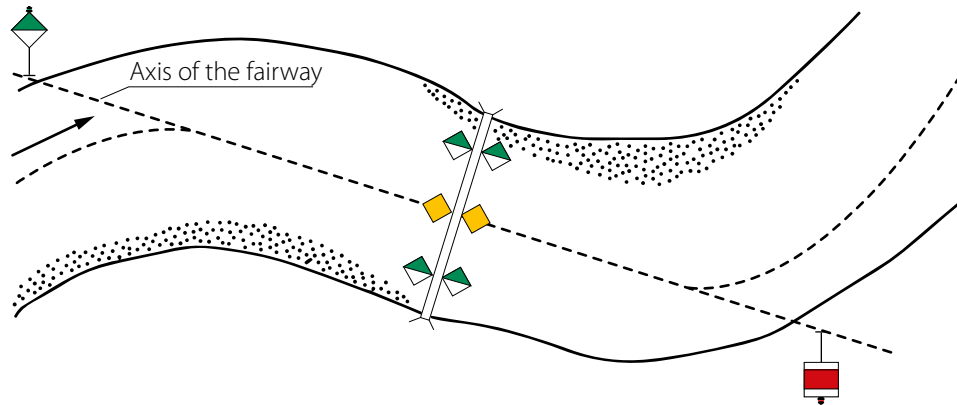
- (a) In order to indicate permission to use the navigable passage of a bridge, only signs A.10, D.1 or D.2 from annex 7 to CEVNI shall be used;
- (b) The installation of marking signs shall be based on depth and current direction measurements, both in the immediate vicinity of the bridge and in the approach sections;
- (c) The positioning of the signs installed in the vicinity of a bridge shall be modified in due course, as conditions of navigation change;
- (d) If, when approaching the bridge or the navigable passage, the direction of the current forms an angle with the bridge, giving rise to eddies around the pillars of the bridge, the floating signs shall be so installed as to indicate the direction of the eddies.

6.4.5 Floating signs may be installed at the approach to the navigable passage to give an exact indication of the position of the fairway.

6.4.6 The following examples show the placement of the aforementioned signs marking the section near bridges:

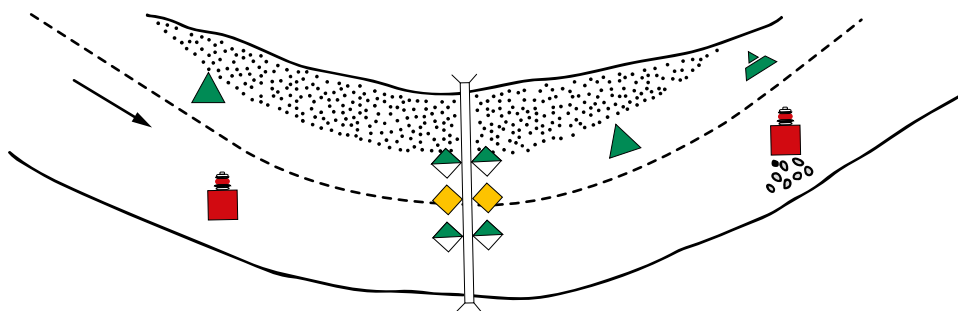
- (a) If a bridge is in a meandering section of the river, the direction of vessels passing through the bridge passages may be marked by bank marks (figure 6.14);

Figure 6.14



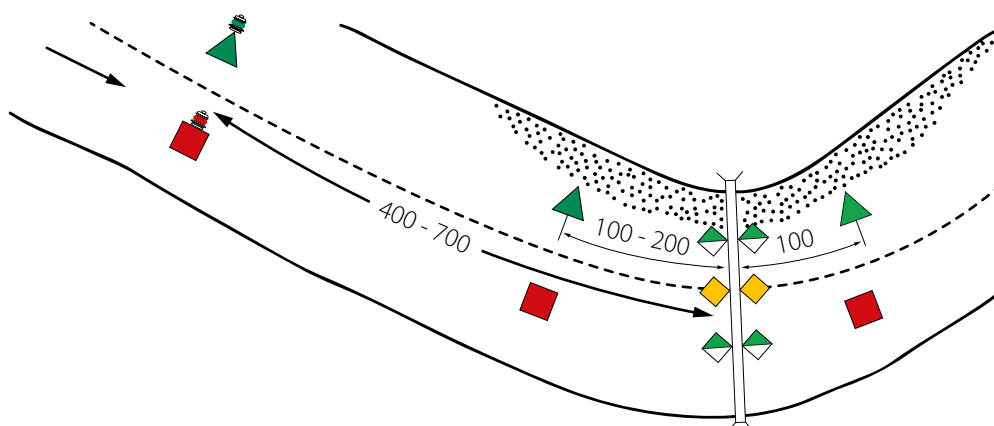
- (b) If, due to a larger curvature of the fairway or for some other reasons, marking by the aforementioned signs is not possible, floating signs (buoys, etc.), placed in order to follow the river flow, may be used (figure 6.15);

Figure 6.15



- (c) If the bridge is positioned on the section where the current makes an angle with the axis of the navigable passage, marking may be done by two pairs of buoys upstream of the bridge. One pair of buoys is placed at a distance of 100 m-200 m upstream of the bridge, and a second pair, 400 m-700 m upstream of the bridge. Buoys further away from the bridge are placed in such a way that, in combination with the pair of buoys closer to the bridge, they mark the river flow. Another pair of buoys may be placed downstream of the bridge at a distance of 100 m from the bridge (figure 6.16).

Figure 6.16



6.5 Installation of floating signs restricting berthing points

6.5.1 Where there is increased intensity of vessels' traffic and the substantial accumulation of vessels in inner harbour basins of ports, not only bank marks should be used in order to restrict berthing places but also floating signs.

6.6 Reference numbers on buoys and marker posts

6.6.1 On buoys and marker posts the use of alphanumeric characters and capital letters is recommended. Where both letters and figures are used, their heights should be the same. Where two such combinations occur, as on junction markers, a hyphen should be used.

6.6.2 Characters should not be less than 200 mm high, white on red or green buoys, or black on yellow buoys.

6.6.3 The characters on a lighted buoy can be black on a white background. Signs are usually affixed to special nameplates. It is recommended that the characters be displayed on both sides of buoys.





Chapter 7 - Marking of harbour entrances

- 7.1 In this chapter, the expression “entrances to harbours” also includes entrances to tributary waterways, entrances to secondary arms of waterways and entrances to docks.
- 7.2 If day marking at the harbour entrance is necessary, the entrance shall be marked:
- To port of a vessel entering: by painting the light pillar, preferably cylindrical, red; or by means of a cylindrical red topmark; or by painting red rectangles on the jetty;
 - To starboard of a vessel entering: by painting the light pillar, preferably conical, green; or by means of a conical green topmark; or by painting green triangles, point upwards, on the jetty.
- 7.3 At night, for small harbours, it shall be sufficient to illuminate the day markings described above. If lights are considered necessary, the entrance shall be marked:
- To port of a vessel entering: by a red light, preferably rhythmic;
 - To starboard of a vessel entering: by a green light, preferably rhythmic.

In the case of a narrow or specially shaped entrance, one of these lights may be sufficient to help a boatmaster to enter the harbour. Such a single light shall be rhythmic.

Figure 4.6 illustrates the provisions of this section for lakes and broad waterways.

- 7.4 The same rules shall apply to the colours and shapes of buoys and marks on fairways leading into the harbour.

It is recommended that lights of the same colour used for signalling the entrance to the harbour and buoying the fairway should have different rhythms to permit differentiation.

The installation of the above lights for marking the entrance to the harbour does not preclude the installation of fixed lights having the meaning attached to them in chapter 5, with a view to regulating navigation. In such cases, the lights marking the entrance to the harbour shall be rhythmic.



Chapter 8 - Marking of permanent structures

8.1 General principle

8.1.1 The marks indicated in figures 8.1 or 8.2 may be used to mark the width of the fairway in openings of bridges and through weirs by showing the site of the piers, or if appropriate, to show the boundaries between which the fairway is normally usable (e.g. where the depth of water or headroom near the piers is insufficient).

Figure 8.1

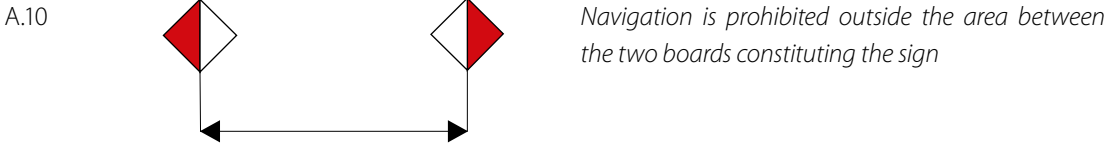
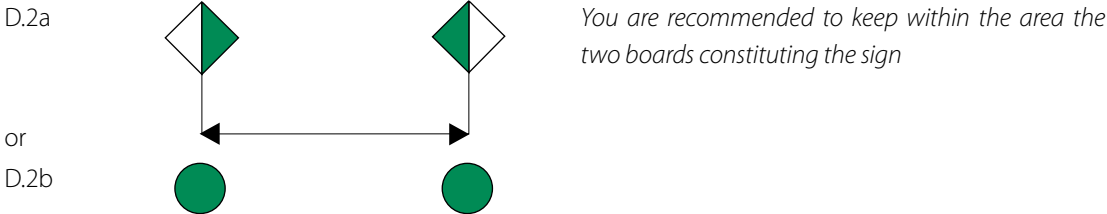


Figure 8.2



For the convenience of boatmasters, inverted scales showing the headroom available under the bridge may be affixed to the piers.

8.1.2 The following may be replaced for fixed bridges, weirs and locks:

- Each fixed red light by a rectangular red board with a horizontal white bar; and
- Each fixed green light by a rectangular green board with a vertical white bar

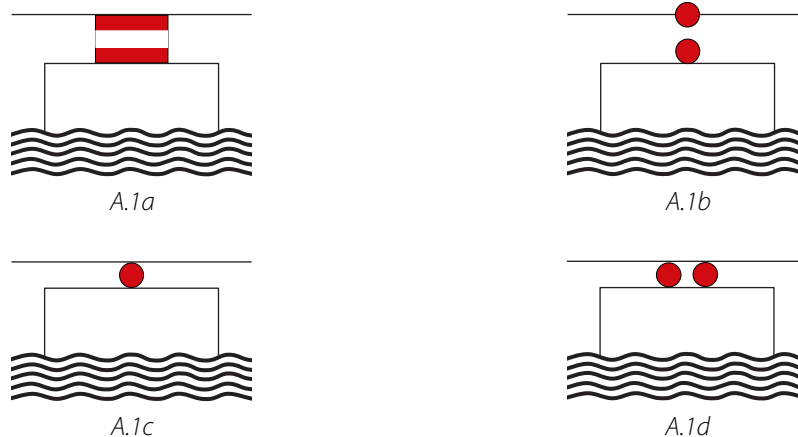
For fixed bridges, the following may be replaced:

- Each fixed yellow light by a square yellow board with the diagonals horizontal and vertical

8.2 Fixed bridges

8.2.1 Entry prohibited

Figure 8.3



8.2.2 Opening recommended for entry (preferable)

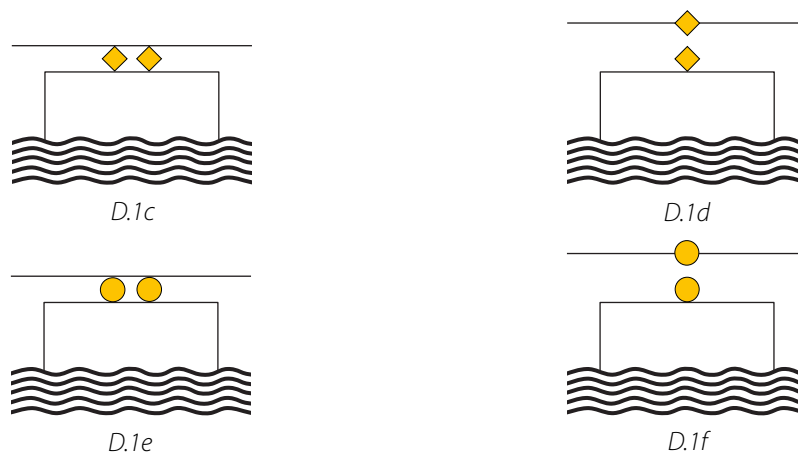
(a) In both directions

Figure 8.4



(b) Only in the direction indicated (passage in the opposite direction prohibited, the entrance of the other side is marked with sign A.1 (see 8.2.1))

Figure 8.5



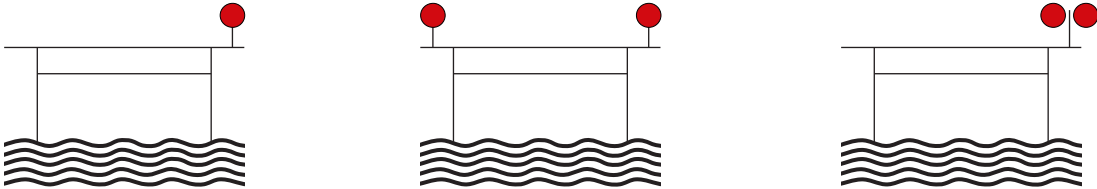
8.2.3 Fairway not expressly recommended

When certain openings in fixed bridges are marked as specified in 8.2.2 and others bear no marks, the boatmaster may use the unmarked openings only at his own risk.

8.3 Movable bridges

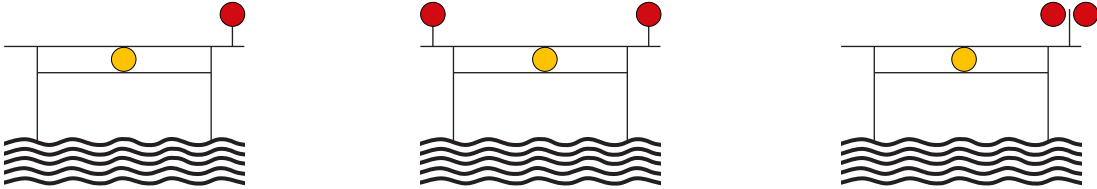
8.3.1 Passage prohibited
(a) General prohibition

Figure 8.6



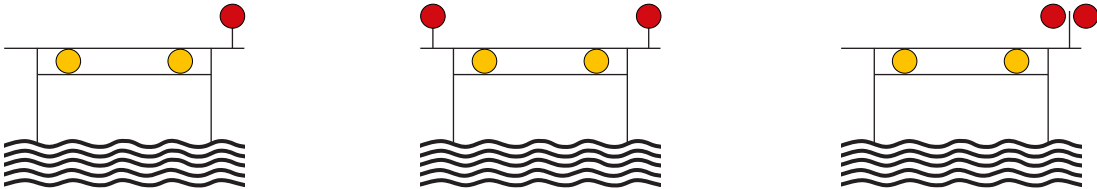
(b) Passage prohibited except for vessels of reduced height; passage authorized in both directions

Figure 8.7



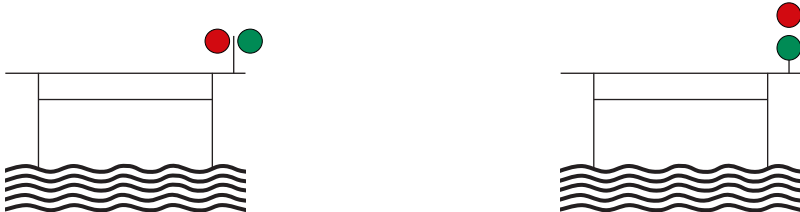
(c) Passage prohibited except for vessels of reduced height; passage prohibited in the opposite direction

Figure 8.8



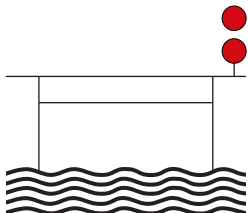
(d) Passage is still prohibited, but the bridge is being opened and the boatmaster should prepare to get under way

Figure 8.9



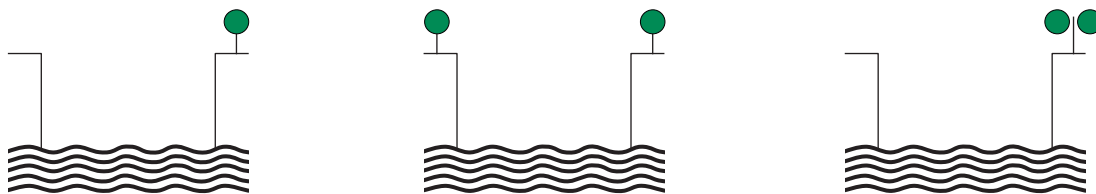
(e) The opening of the bridge for navigation is suspended

Figure 8.10



8.3.2 Passage permitted

Figure 8.11



8.4 Weirs

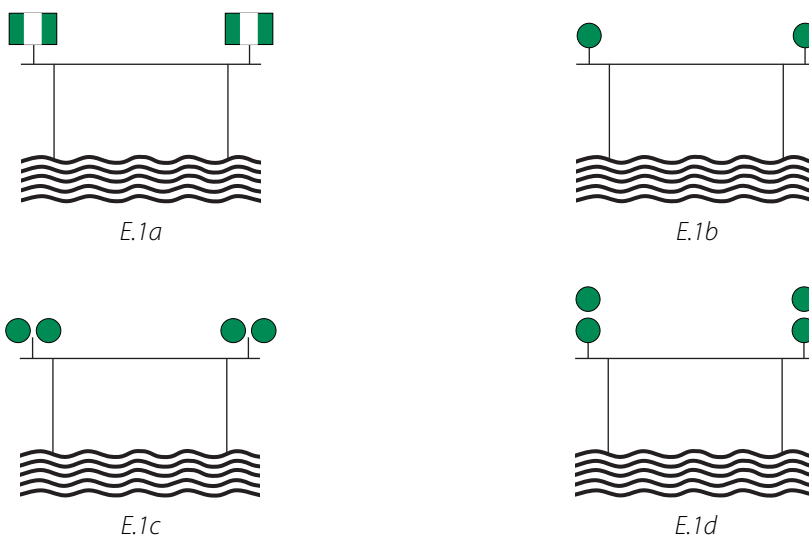
8.4.1 Passage through an opening in a weir is prohibited

Prohibition of passage through an opening in a weir may be indicated by one or more red lights or red-white-red boards (sign A.1) as shown in figure 8.3.

8.4.2 Passage through an opening in a weir is permitted

(a) As a general rule

Figure 8.12



(b) In case of weirs with an overhead bridge

Figure 8.13

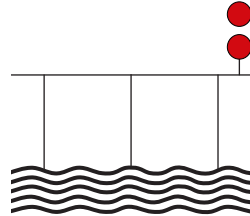


8.5 Locks, ship lifts and inclined planes

8.5.1 Entry or exit prohibited

(a) No entry, lock out of service

Figure 8.14



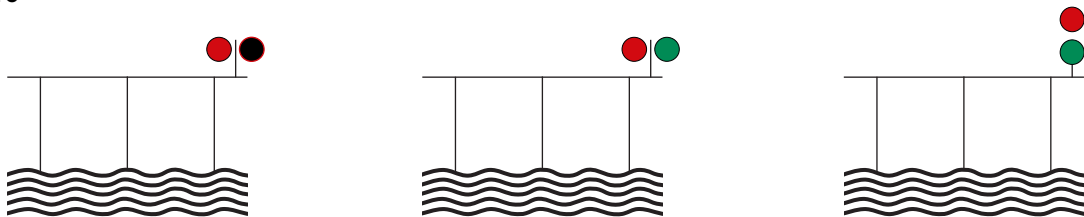
(b) No entry or exit, lock is closed

Figure 8.15



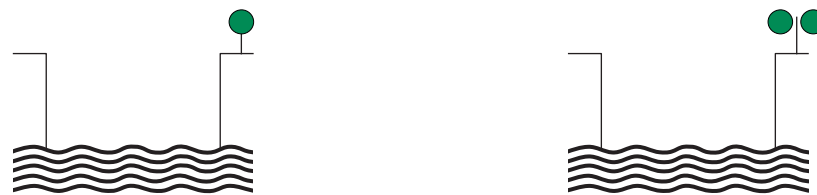
(c) No entry, lock is being prepared for opening

Figure 8.16



8.5.2 Entry or exit permitted

Figure 8.17





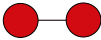


8.5.3 In the absence of lights and boards, it is prohibited to enter and leave locks except by express order of the lock staff.

8.5.4 The provisions of 8.5 also apply to other types of crossings such as ship lifts and inclined planes.





Chapter 9 - Blockage of the waterway

9.1 Suspension of navigation for all vessels

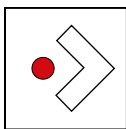
A.1a		In general
A.1b		In general
A.1d		
A.1c		A single red light may be used if it is sufficient clearly to indicate the prohibition and cannot be confused with lights extraneous to the waterway marking lights
A.1f or A.1e		In case of emergency, red flags may be used provisionally by day pending marking with the lights or boards prescribed above

9.2 Prohibition of navigation for motorized vessels

A.12		Motorized craft prohibited
A.1g		No entry for all vessels, with the exception of non-motorized small craft

9.3 Prohibition to enter or leave a harbour or a tributary waterway

One of the signs shown in paragraph 9.1 in combination with the following additional luminous signal:

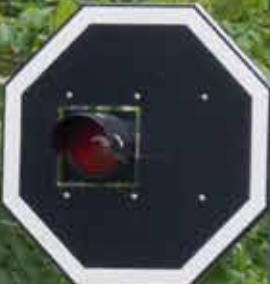


No entry to the basin to which the arrow is pointing



Chapter 10 - Marking of prohibited or restricted zones

- 10.1 If the limits of prohibited or restricted zones need to be indicated, the special marks prescribed in paragraph 4.4 shall be used. The nature of the prohibition or restriction shall so far as possible be notified to users in writing (for instance, in charts) and by local information.
- This information shall preferably be given by means of boards on the bank showing one of the prohibitory or informative signs prescribed in appendix 1 and annex 7 to CEVNI, or by means of the red rectangular board with a white horizontal bar. Such boards shall if necessary be supplemented by an arrow showing the direction of the area to which the sign prescribed in paragraph 3.5.2 (c) applies.
- 10.2 Alternatively, the local information may be carried on the yellow buoys mentioned in paragraph 4.4. It may also be given by means of topmarks placed on the buoys instead of a topmark as prescribed in paragraph 4.4. For example, buoys at the edge of a zone where navigation is totally prohibited may carry a staff with a rigid triangular red pennon. If other topmarks are used, they shall be clearly different from this red pennon and from the topmarks prescribed in sections 3.2-3.4.
- 10.3 If a shore zone in which one or more types of craft or activity are prohibited or restricted is crossed by a fairway in which one such kind of craft or activity is not prohibited or restricted (except as regards an entrance to a harbour to which section 3.2 applies), the sides of the fairway also shall be marked by yellow buoys. The two buoys at the entrance shall be twice the size of the other buoys, and if necessary their upper parts shall be painted red on the right- hand side and green on the left-hand side for a boatmaster leaving the fairway.
- 10.4 On the bank, boards as prescribed in Subsection E “Informative signs”, section 2.1, appendix 1 as well as section E of annex 7 to CEVNI shall indicate the type of craft or activity permitted (e.g., the “water skiing” permission sign to indicate a water-skiing fairway across an area where all navigation, or only water skiing, is prohibited); the markings may be supplemented by the arrow prescribed in paragraph 3.5.2 (c).
- 10.5 Where a zone open for more than one activity is crossed by a fairway in which only one activity is permitted, the sides of the fairway shall be marked as in the above case. If possible, a board on the bank shall indicate the activity permitted.
- 10.6 Figure 4.6 illustrates the provisions of this section as applied to lakes and broad waterways.



WAIT FOR NEXT
LOCKING

Videoüberwachung

Chapter 11 - Variable message signs to regulate traffic

- 11.1 When variable message signs are used to regulate traffic, attention must be paid to the following:
- (a) If variable message signs regulating traffic show images of signs from annex 7 to CEVNI, the images must be depicted using a mechanical display system. Appendices 1 and 3 are applicable with regard to colour selection and dimensions;
 - (b) By night, mechanical display systems shall be externally lighted. Appendix 5 may be applicable;
 - (c) The use of auto-illumination display systems should be avoided for the signs in annex 7 to CEVNI. Inverse representation (e.g. inversion of black and white surfaces for prohibitory signs) shall not be allowed;
 - (d) A remote controlled auto-illumination matrix display may constitute a reasonable alternative in order to indicate frequently changing information, such as water levels and the height of navigable passages through bridges. Technically, it is possible to display images using light emitting diodes, liquid crystals and light guides;
 - (e) By day, there must be sufficient luminosity to ensure the sign can be read; by night, luminosity must be reduced in order to prevent any dazzling and to ensure that the sign can be identified. The image must thus be regulated according to light measurements in the surroundings.
- 11.2 Examples of variable message signs to regulate traffic are contained in appendix 6.

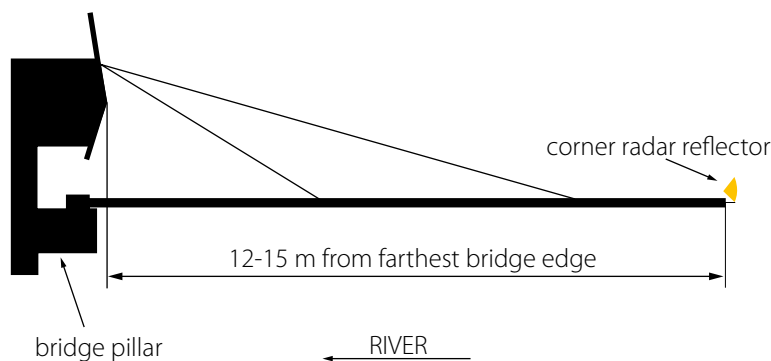


Chapter 12 - Installation of radar reflectors

12.1 Installation of radar reflectors on marking signs and signals and navigable passes through bridges

- 12.1.1 It is important to equip floating signs and bank marks with radar reflectors to ensure their visibility.
- 12.1.2 When marking signs equipped with radar reflectors are installed, account must be taken of the furthest distance between the vessel and the sign in terms of the perception of the sign on the radar screen. This distance depends on the technical characteristics of the radar equipment, the reflective capacity of the radar reflectors and the specific conditions of the river and the height of the antenna installed on the vessel, as well as the height of the radar reflector, both in relation to the water surface.
- 12.1.3 Since the visibility of bridge pillars is usually insufficient on radar screens, the bridge pillars for the passage of vessels upstream and downstream must be marked either by buoys equipped with radar reflectors placed not less than 15-20 m before the bridge, or by radar reflectors installed on the bridge itself not less than 12-15 m from the farthest edge of bridge construction (figure 12.1). A sketch of the recommended radar reflector is contained in section 3.4 of appendix 1.

Figure 12.1



- 12.1.4 Since the radar reflector improves navigation safety, every effort should be made to install them by means of supports on the framework of bridges to mark the navigable passage through the bridge.
- 12.1.5 Navigational hazards and water supply engineering structures (sunken vessels, groynes, cross-beams, etc.) located in the river bed may also be marked by signs equipped with radar reflectors. If the groynes or cross-beams marked by radar reflector signals are located along one of the banks while the fairway follows the opposite bank, which is low and flat, the radar reflector signals may also be placed on that bank so as to facilitate the orientation of vessels navigating by radar.
- 12.1.6 When radar reflectors are used on marking signs and signals, the visibility of the sign must not be diminished. Their colour shall also correspond to the colour of the sign in question.
- 12.1.7 Radar reflectors on fairway buoys are most often manufactured using two vertical metal plates set as a cross, with a horizontal metal plate intersecting them at a right angle. The reflectors should be made of aluminium or stainless steel.
- 12.1.8 Practical experience has shown that there is a need for at least two standard sizes of reflectors on floating signs. Recommended dimensions are as follows:
- Type 1: tip to tip height 420 mm;
 - Type 2: tip to tip height 850 mm.
- 12.1.9 The square plate referred to in paragraph 12.1.7 has a diagonal of 300 or 600 mm respectively and sides of 210 or 425 mm respectively.

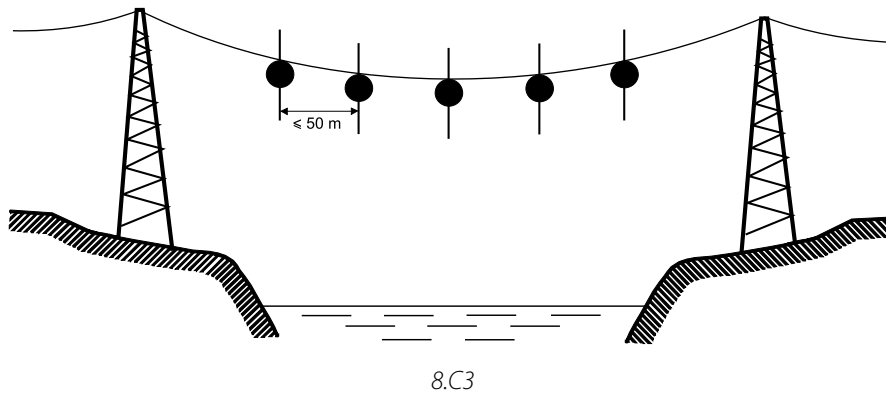
12.2 Buoys and poles with radar reflectors

12.2.1 Examples of buoys and poles with radar reflectors are given in section 3.6.

12.3 Marking of overhead cables (where applicable)

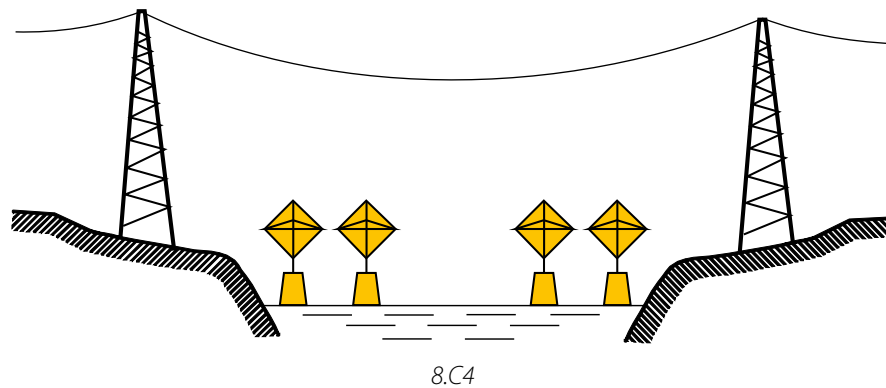
12.3.1 Radar reflectors secured to the overhead cable (giving a radar image of a series of points to identify the overhead cable) are shown in figure 12.2.

Figure 12.2



12.3.2 Radar reflectors placed on yellow floats arranged in pairs near each bank (each pair giving a radar image of two points side by side to identify the overhead cable) are shown in figure 12.3.

Figure 12.3







Chapter 13 - Monitoring of signs and marking by AIS Aids to Navigation

13.1 Function of AIS Aids to Navigation

- 13.1.1 AIS AtoN is designed for displaying navigation signs and marks on electronic navigation charts. A special type of AIS station (AtoN AIS) fitted to an AtoN provides a reliable identification and visualization of the AtoN on board. In addition, this equipment can provide information and data that would:
- complement or replace an existing aid to navigation, providing identity, state of “health” and other information to surrounding ships or back to a shore authority;
 - provide the position of floating aids (mainly buoys) by transmitting an accurate position to monitor if they are on station;
 - provide real-time information for performance monitoring, with the connecting data link serving to remotely control changes in AtoN parameters or switching on back-up equipment;
 - gather data AIS fitted shipping traffic for future aid to navigation planning purposes.
- 13.1.2 The use of AIS as an AtoN can provide the following services to AIS equipped vessels:
- Provide identification of the AtoN in all weather conditions;
 - Complement existing signals from AtoN;
 - Transmit accurate positions of floating AtoN;
 - Indicate if a floating AtoN is off position;
 - Mark or delineate tracks, routes, areas, and limits;
 - Provide additional AtoN capability through use of virtual AIS AtoN where installation of physical AtoN is technically or economically difficult;
 - Indicate AtoN status; and
 - Provide an accurate position for fixed AtoN.

13.2 Types of AIS Aids to Navigation

- 13.2.1 Real AIS AtoN is an AIS station located on an AtoN that physically exists.
- 13.2.2 Synthetic AIS AtoN is where the AtoN message is transmitted from a remote AIS station for an AtoN that does physically exist.
- 13.2.3 Virtual AIS AtoN is transmitted as an AIS AtoN message for an AtoN that does not physically exist. When a virtual AIS AtoN is used, the AtoN symbol or information would be available for presentation to a boatmaster on an electronic chart, even though there is no real AtoN such as a buoy or beacon.



Chapter 14 - Regional and national special requirements

14.1 Introduction

- 14.1.1 The competent authorities may omit, complement or modify the provisions of chapters 1-13 and, in particular, the provisions listed in this chapter, when this is required by the conditions of navigation. In this case, they shall report on these differences to the Working Party on Inland Water Transport (SC.3).
- 14.1.2 The competent authorities shall also report to SC.3 the additional local requirements existing in their region or on a particular river section.

14.2 Chapter 1 - General

- 14.2.1 Paragraph 1.1.8: the competent authorities may use marks, supplementary to those indicated in Article 1.1.1, for marking on a particular waterway or a waterway network, provided that their shape, colour and symbols used are consistent with the provisions of SIGNI, and they cannot be confused with the marks provided by SIGNI.
- 14.2.2 Paragraph 1.3.1: the competent authorities may prescribe other shapes for boards bearing special signs:
- (a) Round;
 - (b) Triangular;
 - (c) Diamond;
 - (d) Trapezoidal;
 - (e) A combination of two shapes indicated above.

14.3 Chapter 2 - Visibility of signs and lights

- 14.3.1 Paragraph 2.2.2: the competent authorities may prescribe special provisions for the minimal dimensions of signs and boards provided that they ensure adequate navigation safety.
- 14.3.2 Paragraph 2.2.3: if the minimum height between the water surface and the lower rim of the board of the lowest sign of 1.5 m cannot be met due to local conditions, the competent authorities may prescribe other requirements to ensure proper visibility.
- 14.3.3 Paragraph 2.2.7: the competent authorities may prescribe other provisions provided that they ensure adequate navigation safety.
- 14.3.4 Paragraph 2.3.2: the competent authorities may apply other norms for the determination of the luminous intensity and the range of lights:
- (a) Recommendation on the Determination of the Luminous Intensity of Marine Aid-to-Navigation Lights, December 1977, IALA Bulletin No. 75-1978-3;
 - (b) IALA Recommendations E-200 on Marine Signal Lights;
 - (c) Interstate Standard GOST 26600-98 "Navigation signs for inland waterways. General specifications".

14.4 Chapter 3 - Buoyage and marking of the waterway

- 14.4.1 Paragraph 3.1.2: the competent authorities may apply temporary signs and marking:
- (a) Flood marks in the spring;
 - (b) Temporary marks at critical water levels;

- (c) Orientation marks;
 - (d) Replacing of buoys with light signals by buoys fitted with radar reflectors.
- 14.4.2 Paragraphs 3.2.1 and 3.2.2: the competent authorities may prescribe other colours and/or shapes of floating marks for the waterway limits:
- (a) White and/or black colours of buoys for marking the left-hand side of the fairway;
 - (b) White and/or yellow colours of lights for marking the left-hand side of the fairway;
 - (c) Other shapes of floating signs.
- 14.4.3 Paragraph 3.2.3: the competent authorities may prescribe other colours and/or shapes of floating marks for the bifurcation of the waterway:
- (a) Red and white or red and black colours of bands; bands may be vertical;
 - (b) White, yellow or red colour of lights;
 - (c) Paired red and white marks.
- 14.4.4 Section 3.3: the competent authorities may apply special provisions for marking of danger points and obstacles:
- (a) Shapes of marks and other colours of lights other than indicated in paragraphs 3.3.1-3.3.3;
 - (b) Different marking of danger points and obstacles:
 - (i) Without requiring vessels under way to move in a particular direction;
 - (ii) When prescribing the side for the passage of vessels;
 - (iii) When requiring vessels under way to avoid causing wash.
- 14.4.5 Section 3.4: for the indication of the position of the fairway using the bank marks, the competent authorities may prescribe:
- (a) Other colours and/or shapes of the bank marks for indicating the position of the fairway near the right and left banks;
 - (b) Paired cross-over marks having other shapes and colours of boards and/or other colours and types of lights for marking of cross-overs;
 - (c) Yellow signal rafts;
 - (d) Special marks for visualization on electronic charts.

14.5 Chapter 5 - Lights

- 14.5.1 Paragraph 5.1.1: the competent authorities may use other documents for the determination of the colour of lights:
- (a) CIE Publication No. 2.2-1975 (TC-1.6);
 - (b) IALA Recommendation E-200;
 - (c) Interstate Standard GOST 26600-98 "Navigation signs for inland waterways. General specifications".
- 14.5.2 Paragraph 5.2.2: the competent authorities may prescribe special meanings to signals given by fixed lights as compared to those given in table 5.1.
- 14.5.3 Paragraph 5.5.2: the competent authorities may prescribe special signalling systems for semaphores on a particular waterway section, on floating bridges, etc. Such systems may comprise signal marks, in addition to lights.
- 14.5.4 Section 5.3: the competent authorities may use other types of rhythmic lights in addition to, but not contradicting with those in appendix 4.

14.6 Chapter 6 - Installation of signs and marking in characteristic sections of the river

- 14.6.1 Paragraphs 6.2.10 and 6.3.3-6.3.5: the competent authorities may use special signs and marks and apply special requirements for their installation:
- (a) On meandering sectors;
 - (b) On shoals;
 - (c) For the indication of the fairway (see paragraph 14.4.5).

14.7 Chapter 7 - Marking of harbour entrances

- 14.7.1 Paragraph 7.4: the competent authorities may apply special signs and marks:
- (a) For entrances to harbours and canals;
 - (b) For marking of the berthing area limits.

14.8 Chapter 8 - Marking of permanent structures

- 14.8.1 Section 8.2: the competent authorities may apply special marking in the navigable pass of the bridge:
- (a) Of the fairway axis;
 - (b) Of the waterway limits and the under-bridge clearance height.
- 14.8.2 Section 8.3: the competent authorities may apply special light signals and marking for movable bridges.
- 14.8.3 Section 8.5: the competent authorities may apply other colours of light signals for locks.

14.9 Chapter 9 - Blockage of the waterway

- 14.9.1 Chapter 9: the competent authorities may apply other signs for the stoppage of navigation:
- (a) Sign A.1 on a yellow buoy (for complete stoppage of navigation);
 - (b) Special signs ("Semaphore").

14.10 Chapter 10 - Marking of prohibited or restricted zones

- 14.10.1 Chapter 10: the competent authorities may provide special instructions about prohibited or restricted zones on pilot charts instead of/in addition to yellow buoys.

14.11 Chapter 12 - Installation of radar reflectors

- 14.11.1 Section 12.1: the competent authorities may require the installation of radar reflectors on marking signs and signals:
- (a) For floating marks only;
 - (b) For signs and marks of special construction;
 - (c) For waterways for navigation using a radar.



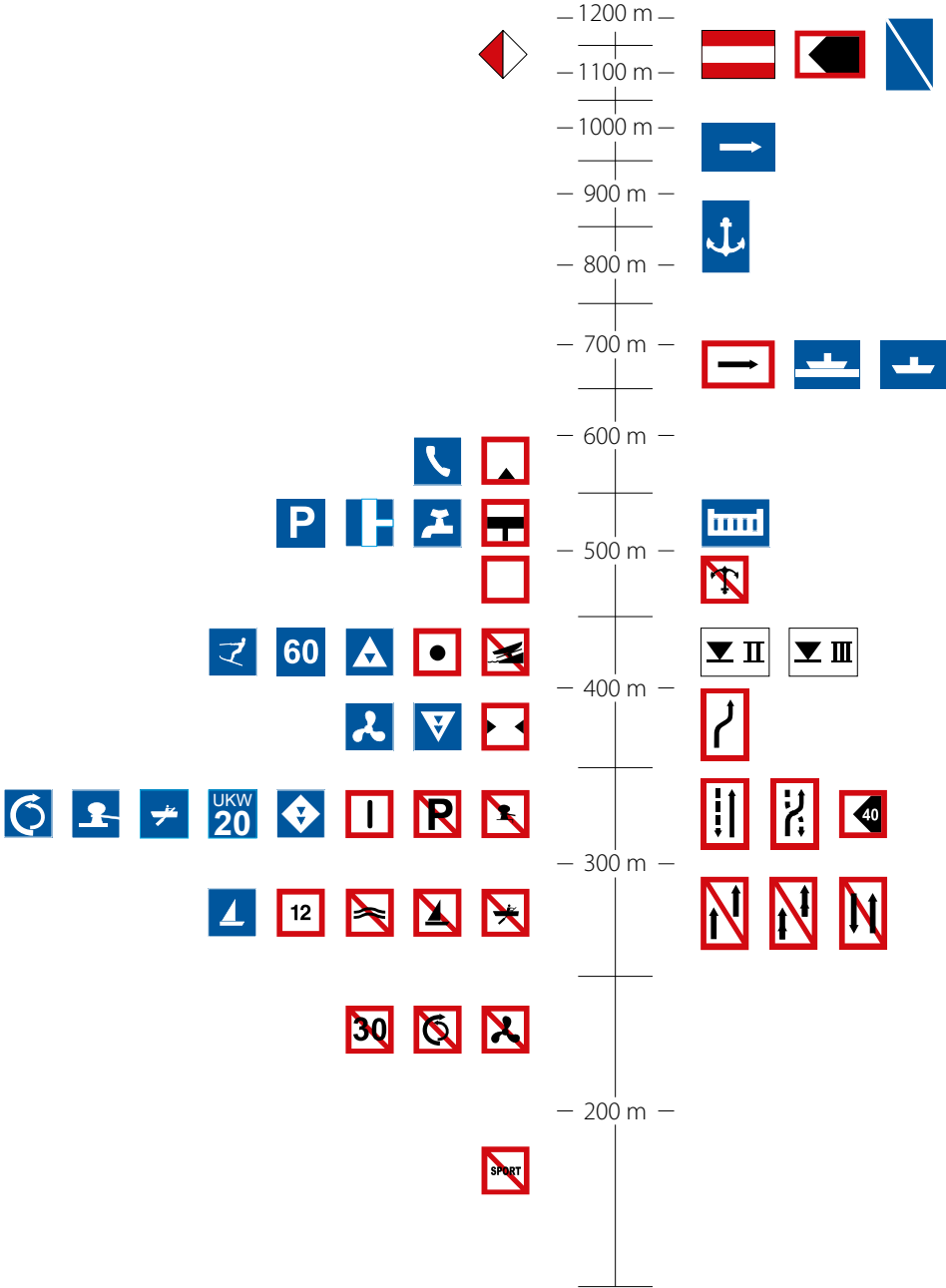
Appendix 1 - Minimal dimensions of the signs from annexes 7 and 8 of the European Code for Inland Waterways

1. Visibility of signs

Guidance on the maximum distances at which the various signs are visible is given in the figure 1.² The distances are valid for boards with dimensions of 100 cm x 100 cm and 150 cm x 100 cm, with the observer positioned at a right angle to the surface of the board. When using boards of other dimensions, the distance at which the sign is visible should be recalculated according to the chosen scale.

Sign images:

Figure 1



² Etude de la perceptibilité des symboles et des inscriptions sur les signaux de navigation (Study of symbol and inscription visibility on navigation signs), Gerdes, presented at the 1990 International Conference on Maritime Signs.

Characters:

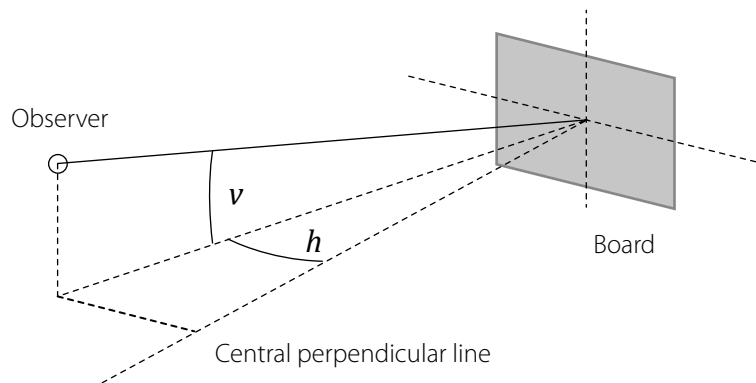
For many types of European characters (e.g. DIN 1451), when using black type on a white background, the maximum readability distance D — if the observer is positioned at a right angle to the surface of the board — is approximately $D \approx 465 h$, where h equals the height of the character (height of capital letters above the line).

Viewed at an angle:

If seen askew (see figure 2), the maximum visibility or readability distance of the board is reduced each time by the cosine of angles h and v between the observer and the central perpendicular line:

$$D(h, v) = D_0 \cos(h) \cos(v).$$

Figure 2

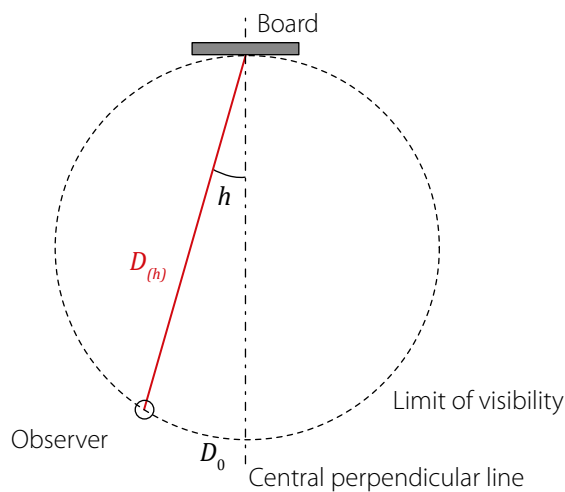


When the observer is at a great distance (see figure 3), the vertical angle shall be considered to be approximately 0 : $v \approx 0$. In such cases, the following formula can be used as guidance to determine the visibility distance:

$$D(h, v) \approx D(h) = D_0 \cos(h).$$

The area of visibility is thus a circle with a diameter of D_0 .

Figure 3



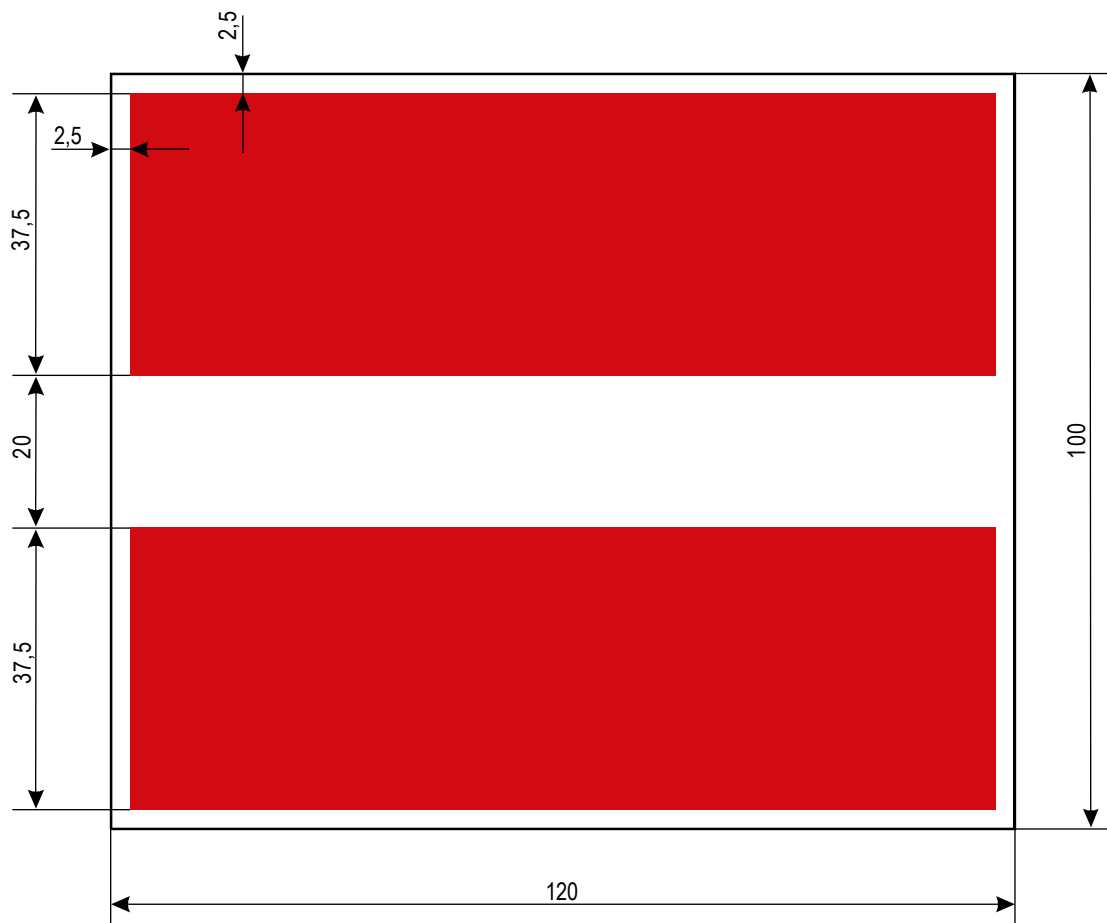
2. Minimal dimensions of the signs contained in annex 7 to the European Code for Inland Waterways

2.1 Main signs

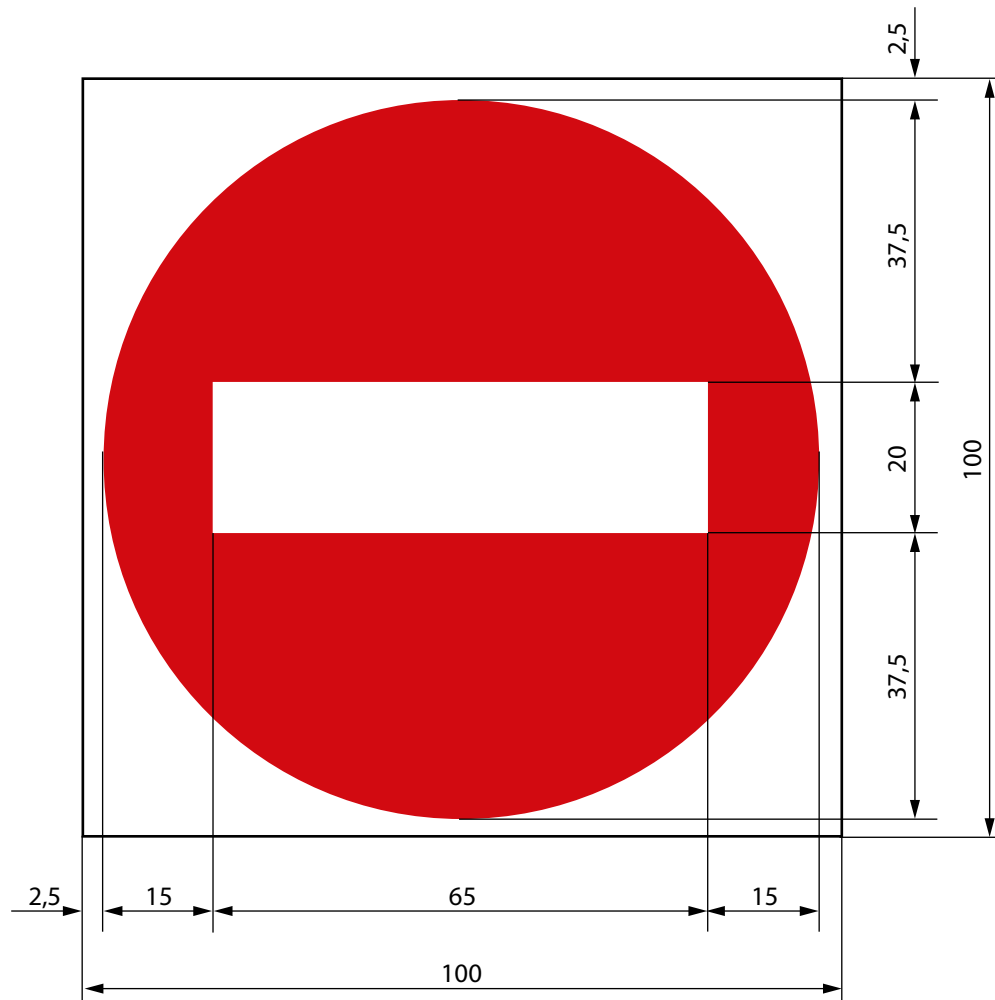
A. Prohibitory signs

A.1 No entry

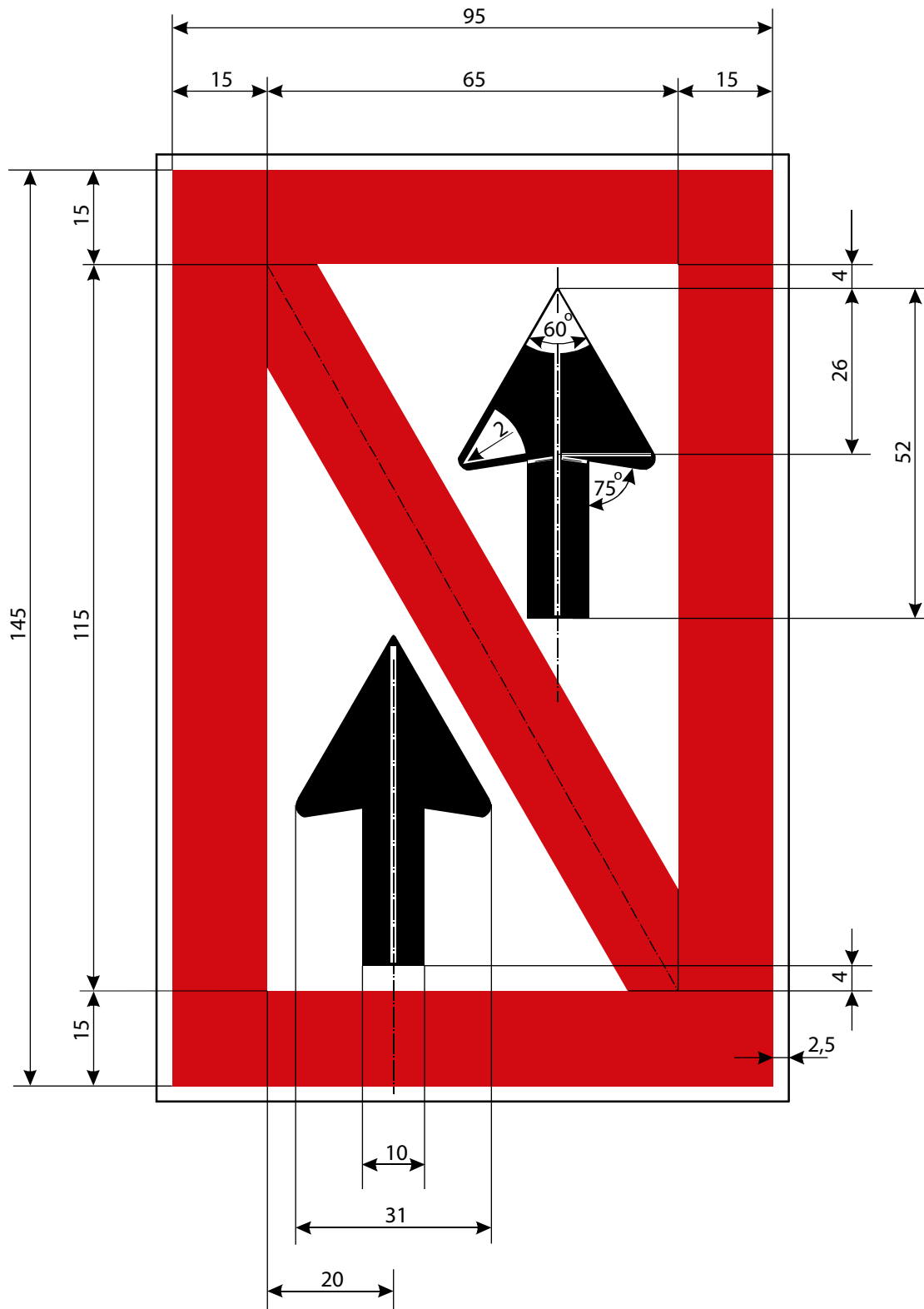
A.1a Board



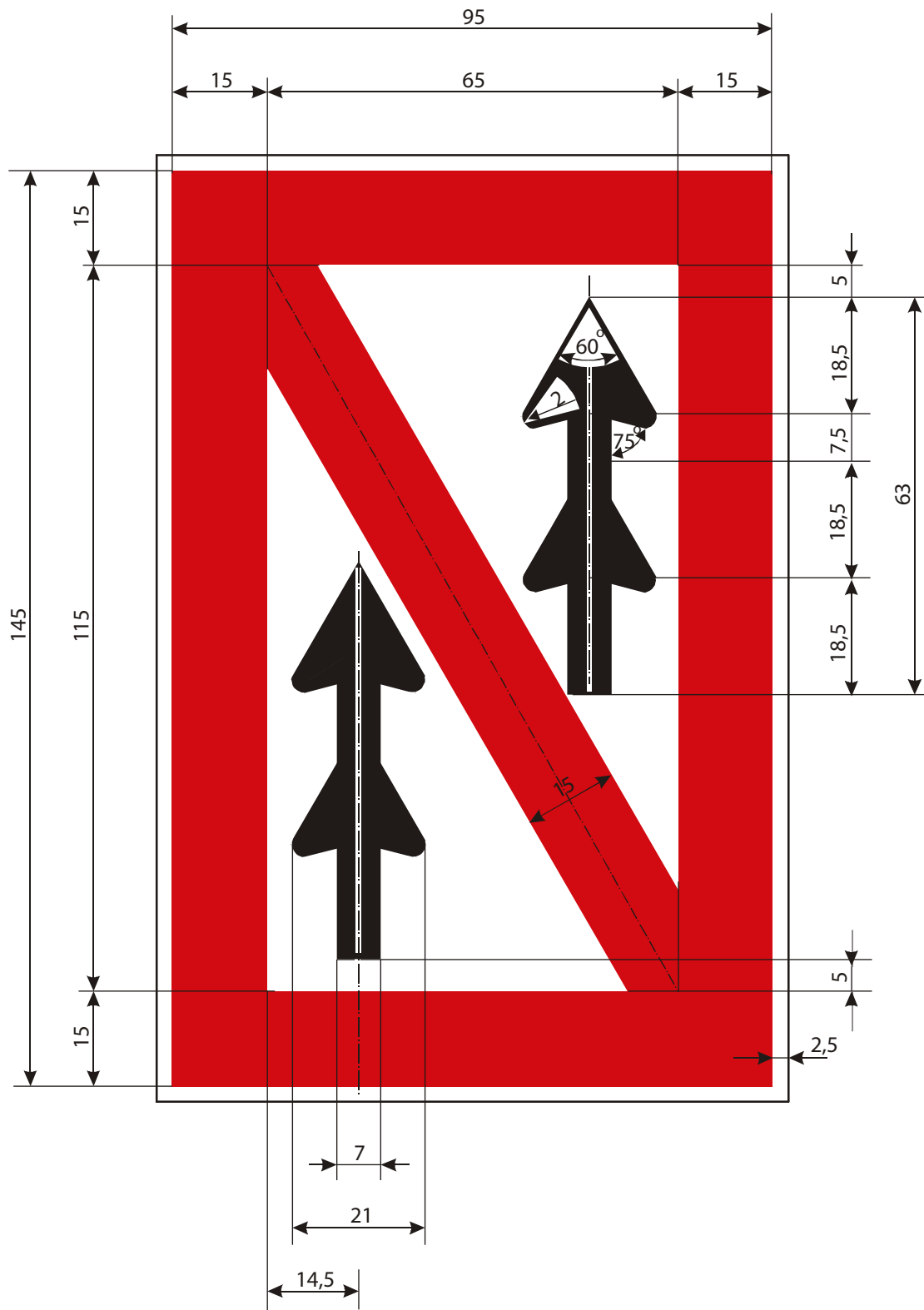
A.1.1 Sections closed to use, no entry except for non-motorized small craft



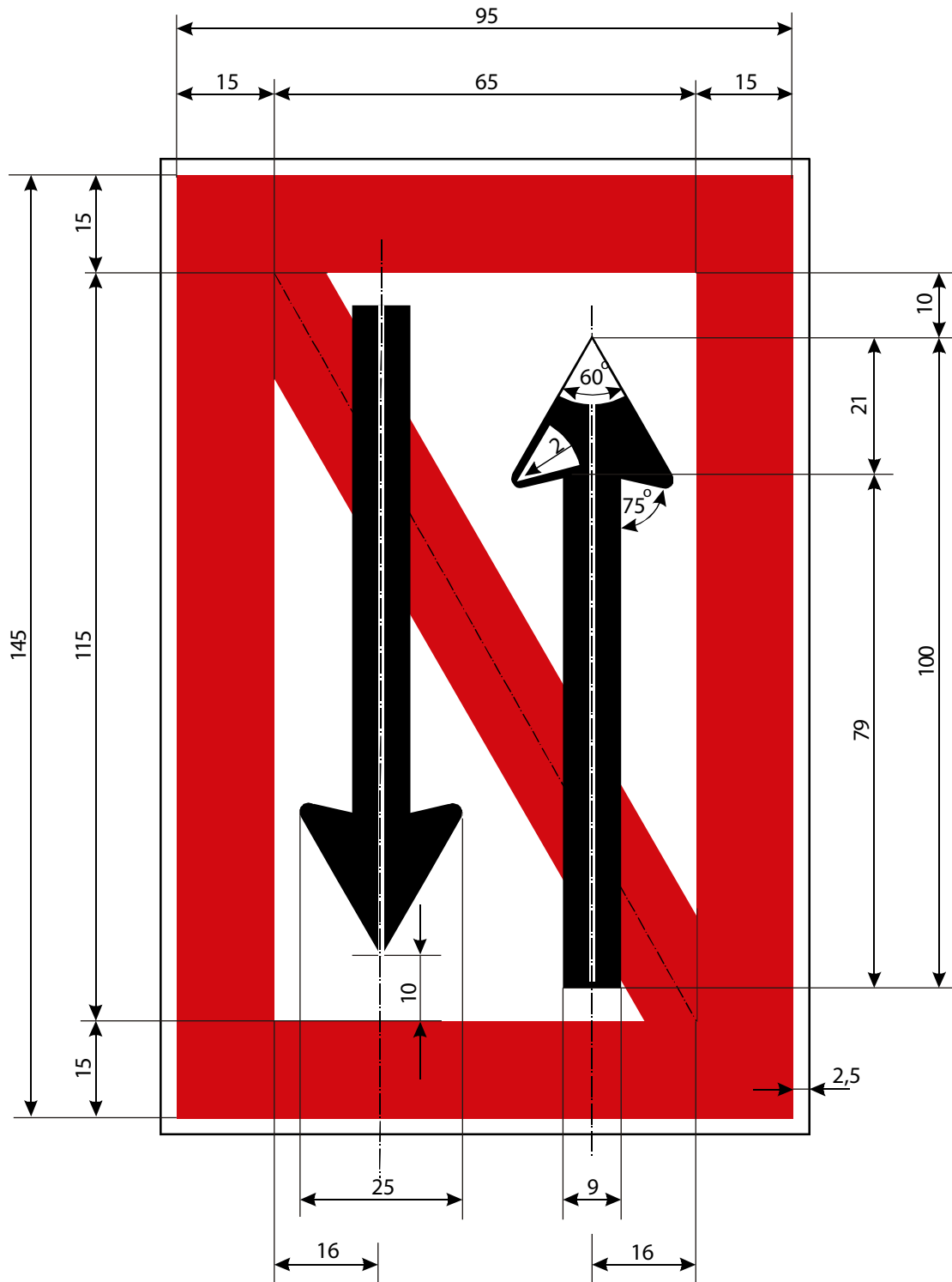
A.2 No overtaking



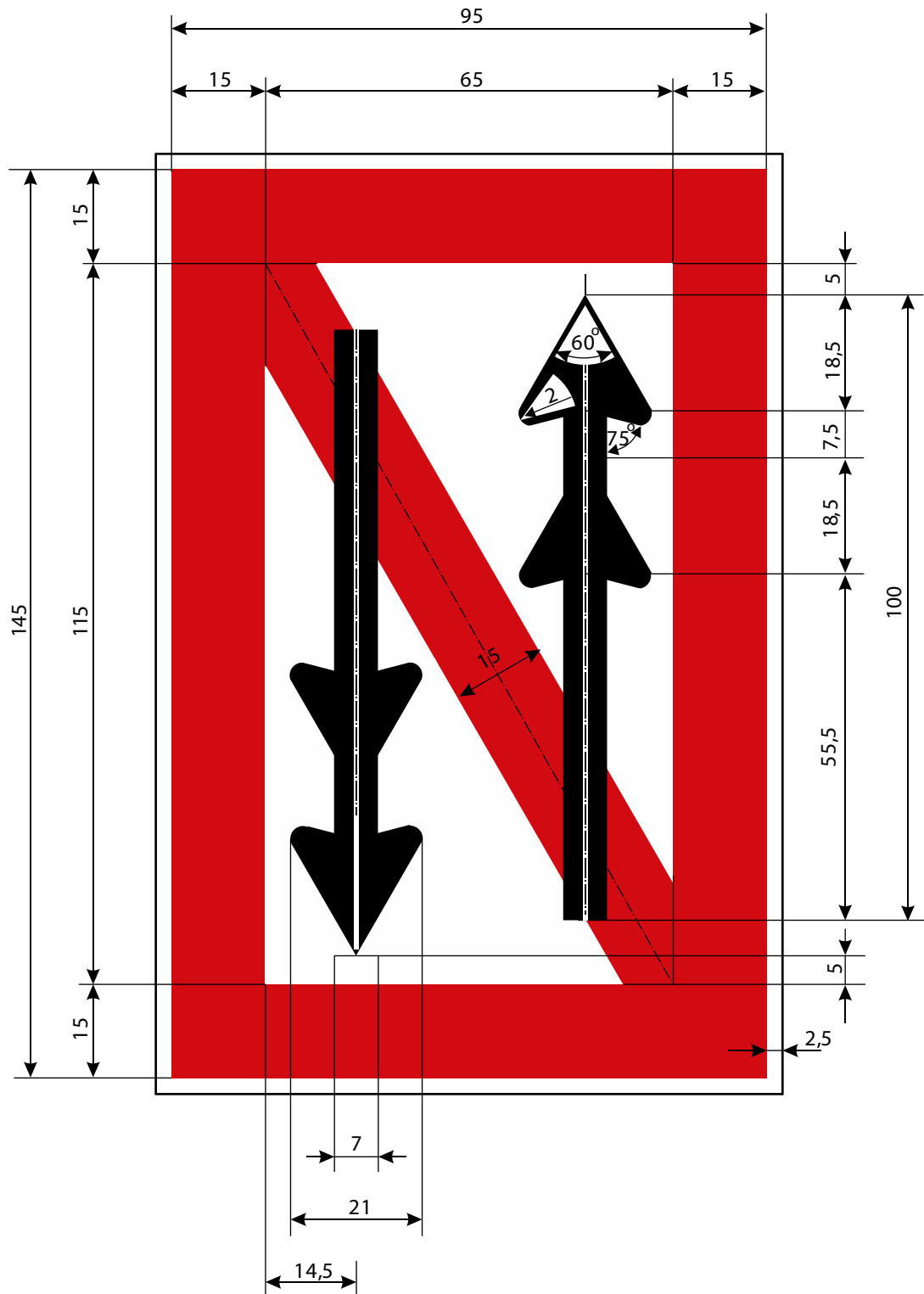
A.3 No overtaking of convoys by convoys



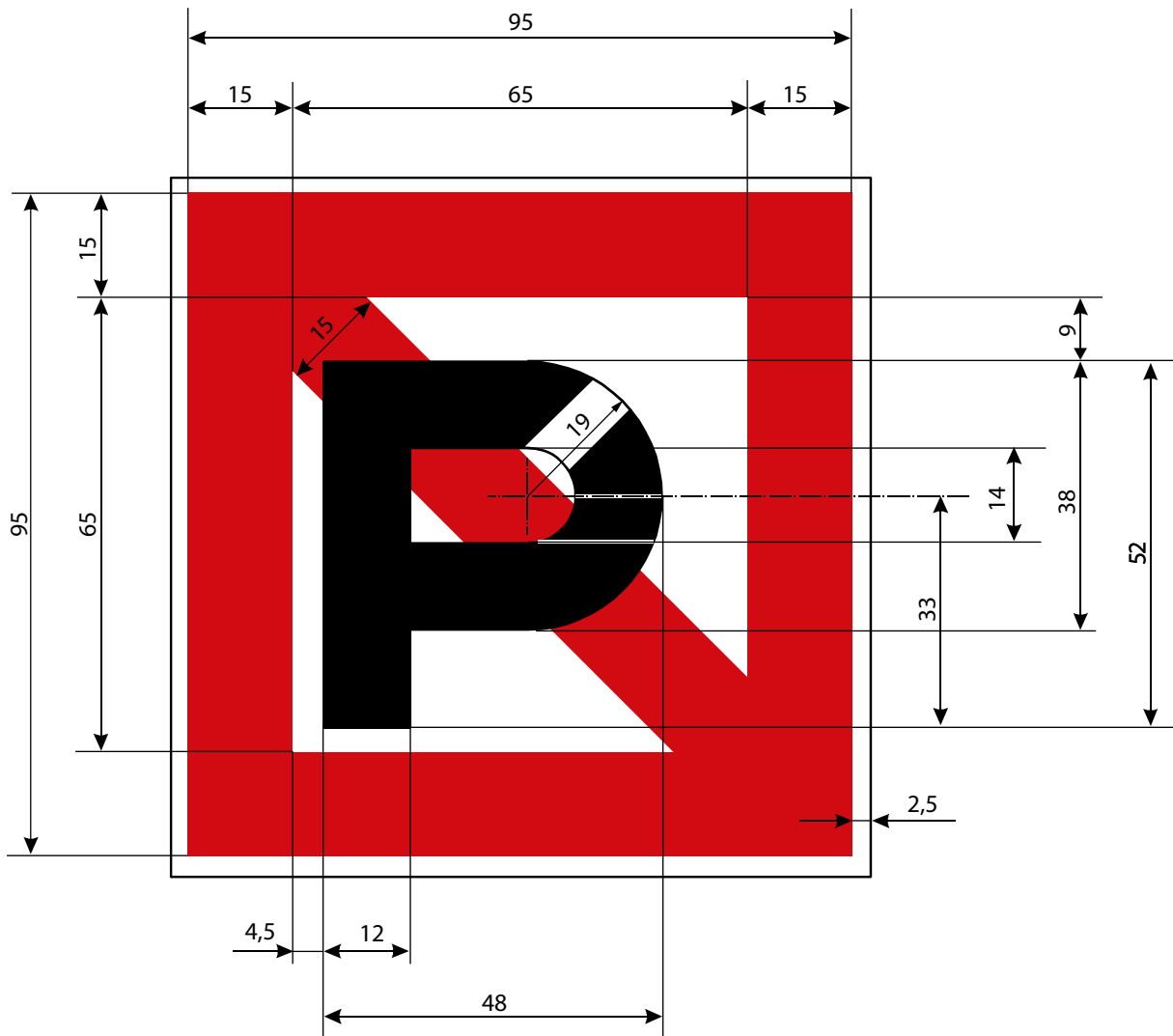
A.4 No passing or overtaking



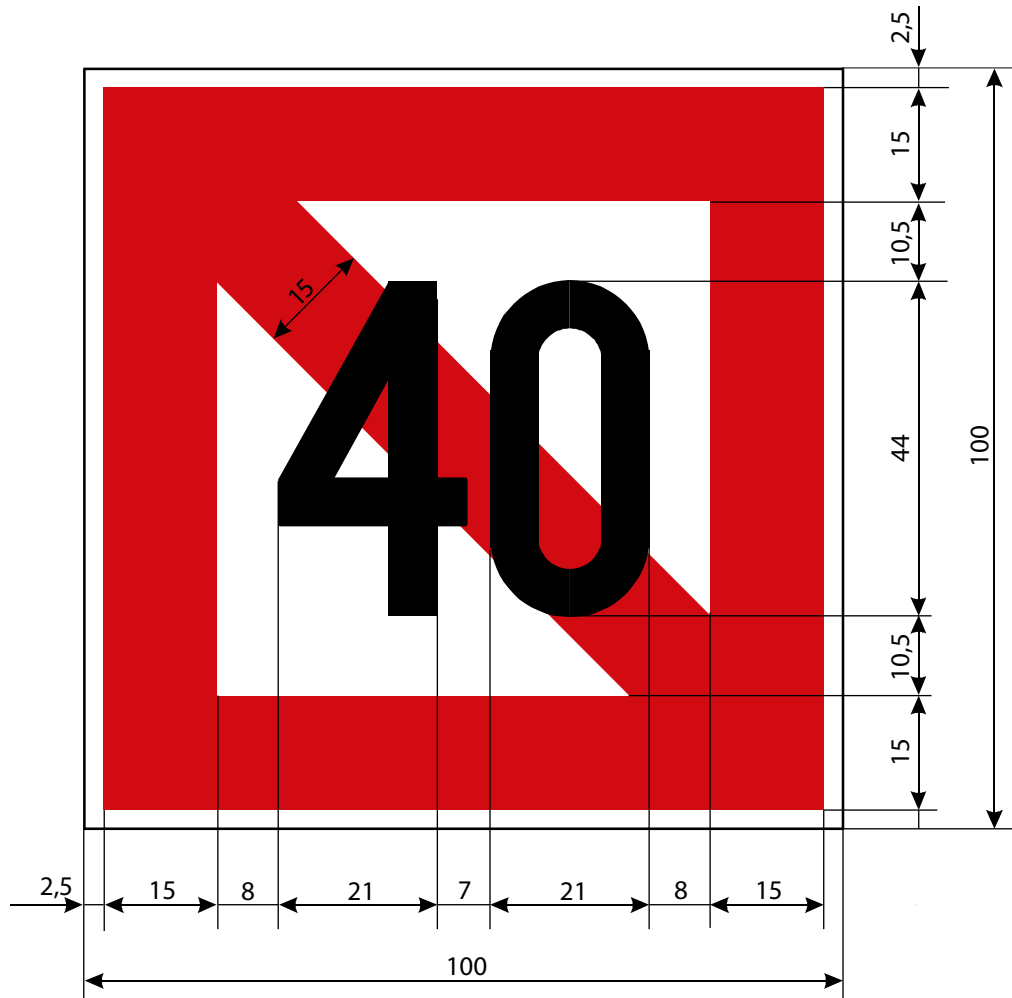
A.4.1 No passing or overtaking of convoys by convoys



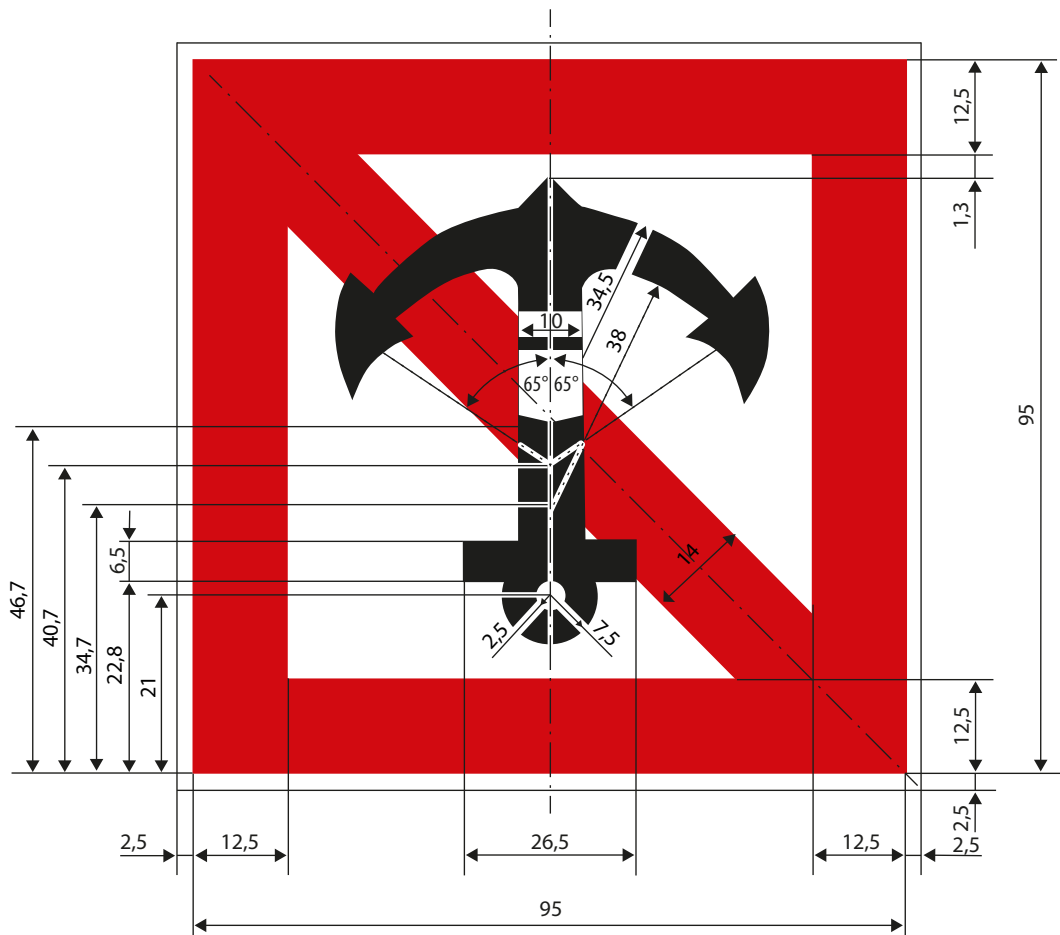
- A.5 No berthing on the side of the waterway on which the sign is placed (i.e. no anchoring or making fast to the bank)



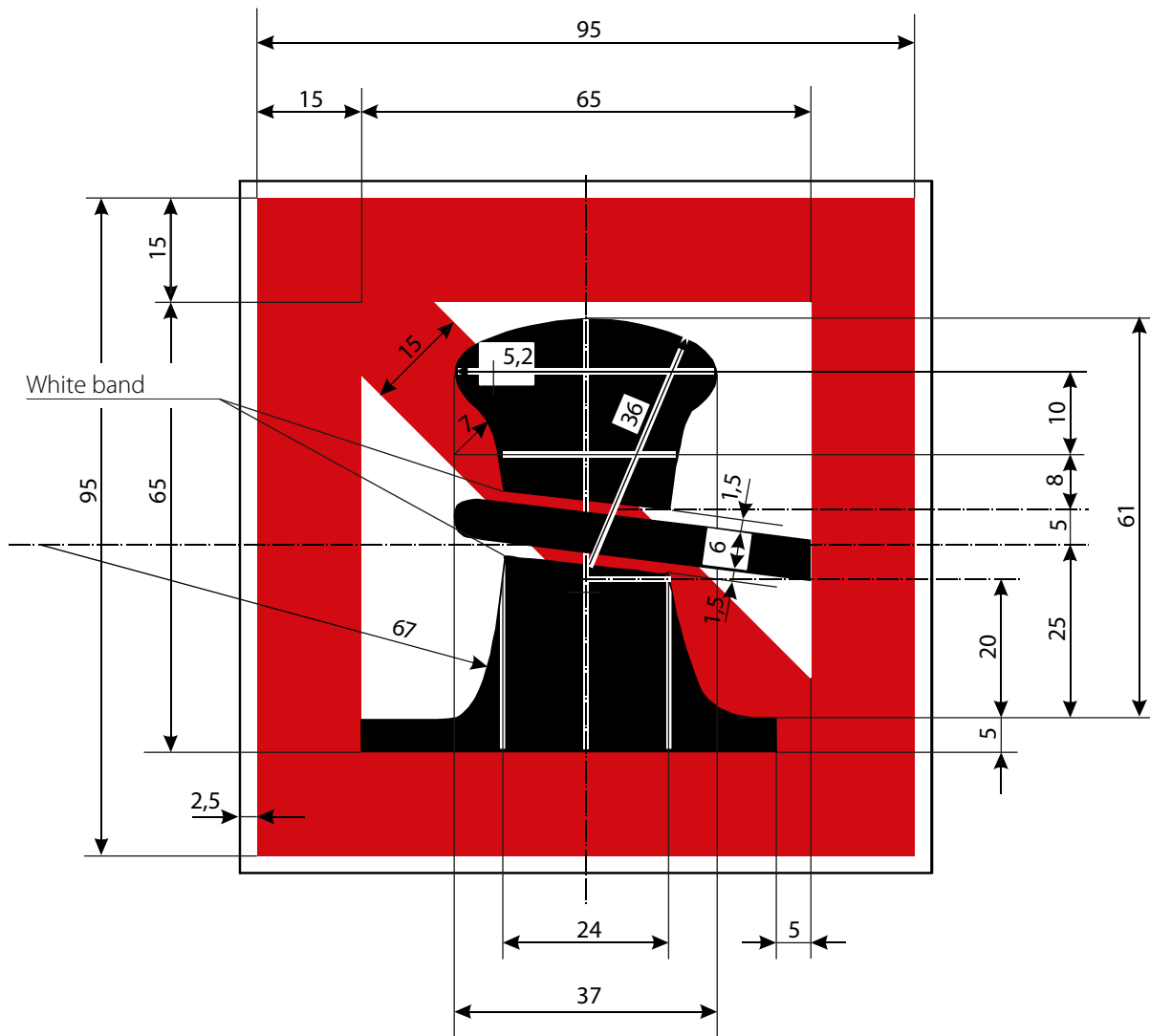
- A.5.1 No berthing on the stretch of water whose breadth, measured from the sign, is shown in metres on the sign



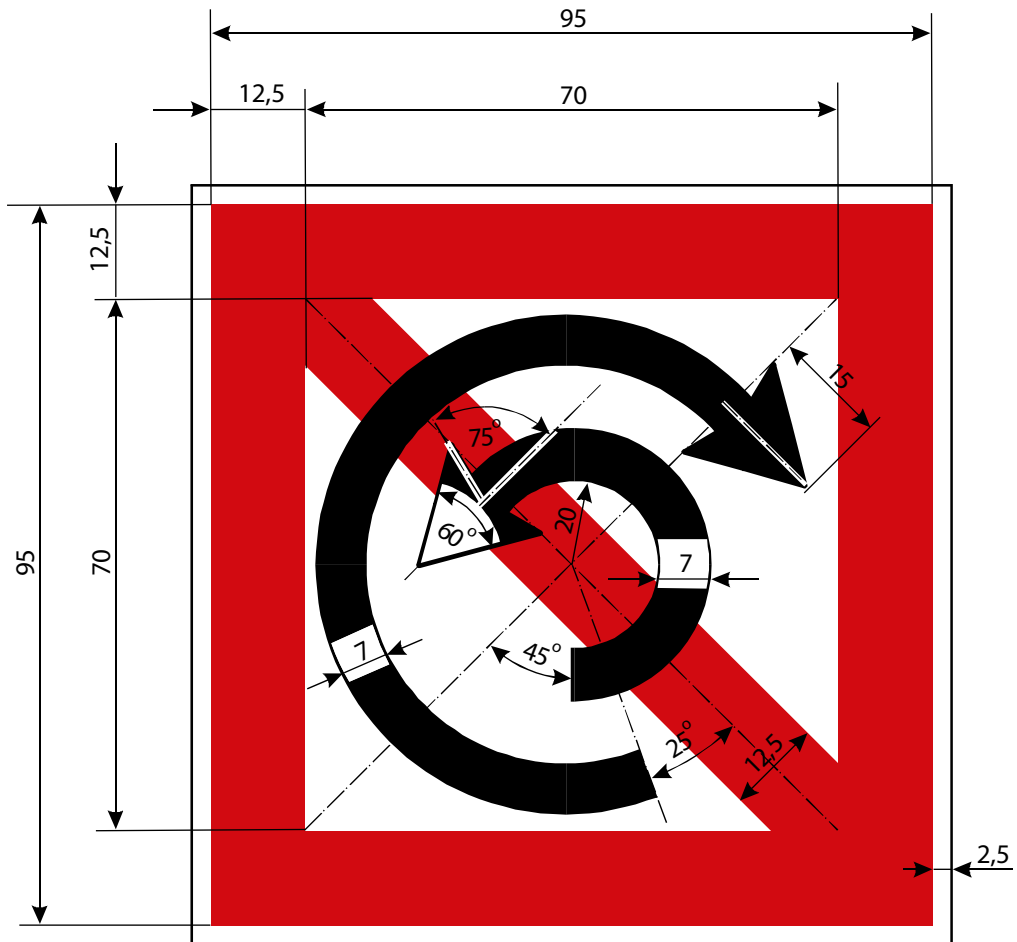
A.6 No anchoring or trailing of anchors, cables or chains on the side of the waterway on which the sign is placed



A.7 No making fast to the bank on the side of the waterway on which the sign is placed

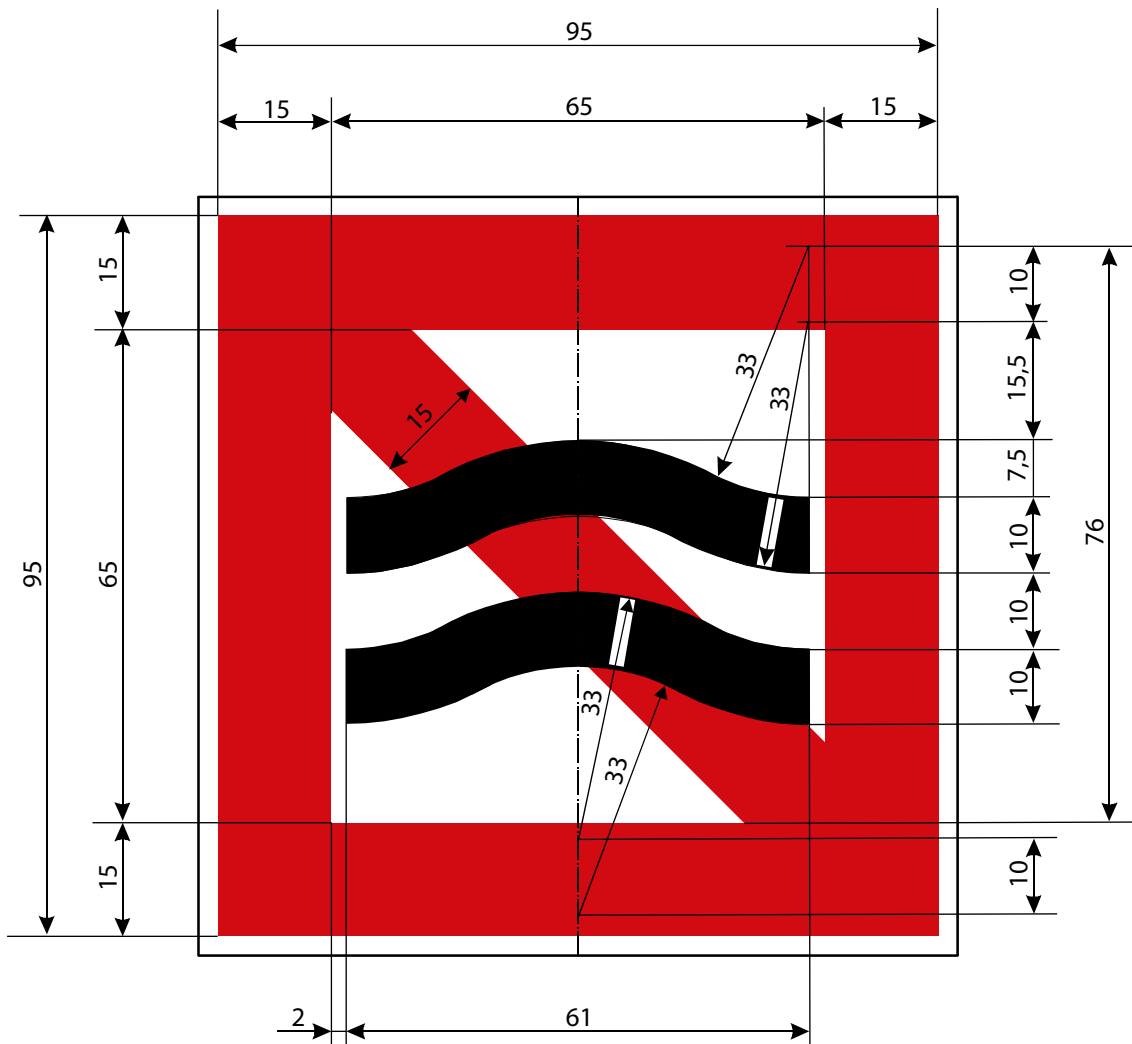


A.8 No turning

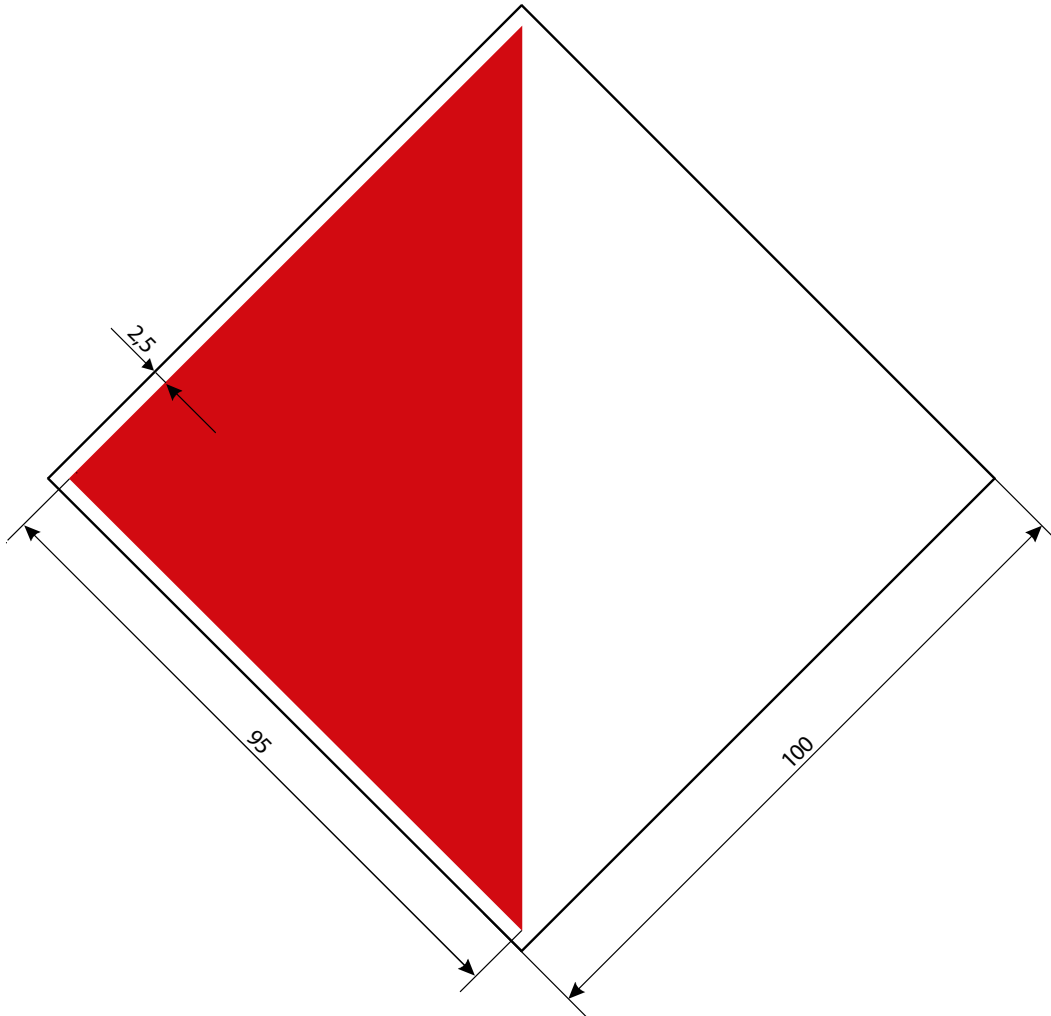


A.9 Do not create wash likely to cause damage

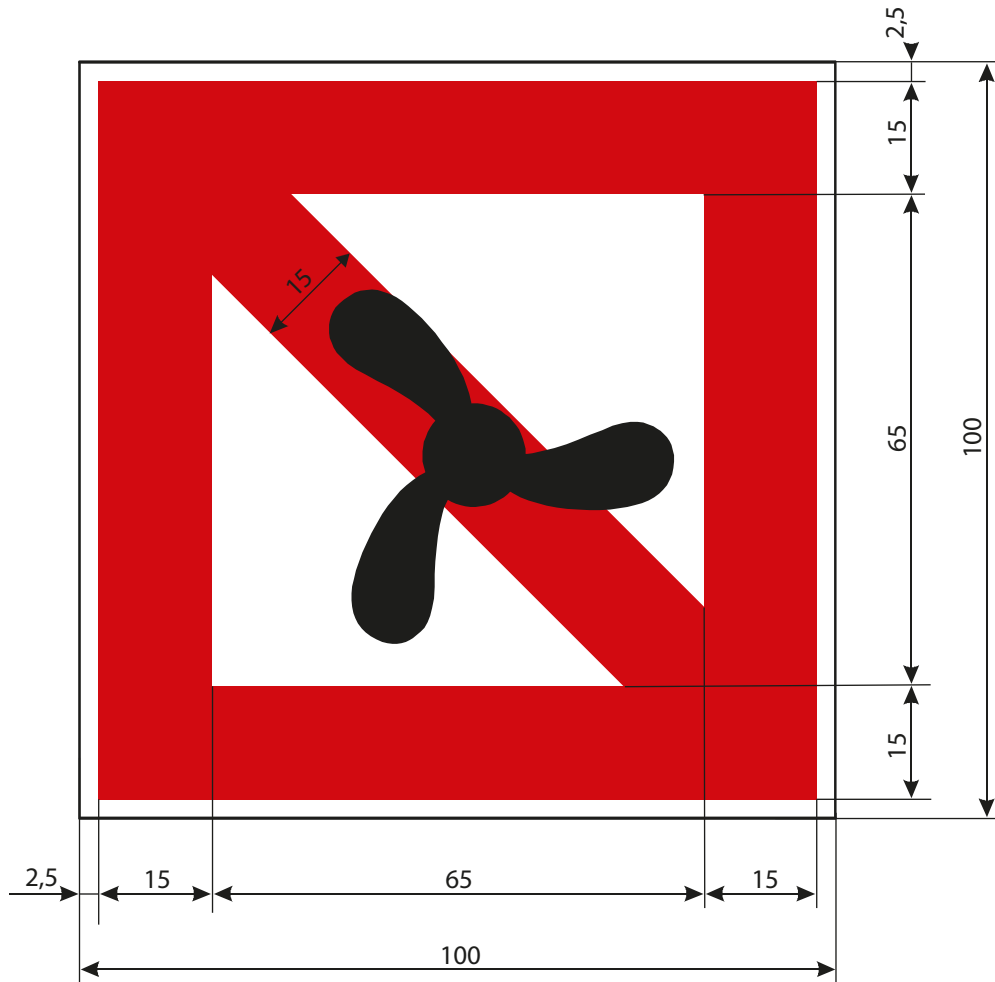
A.9a



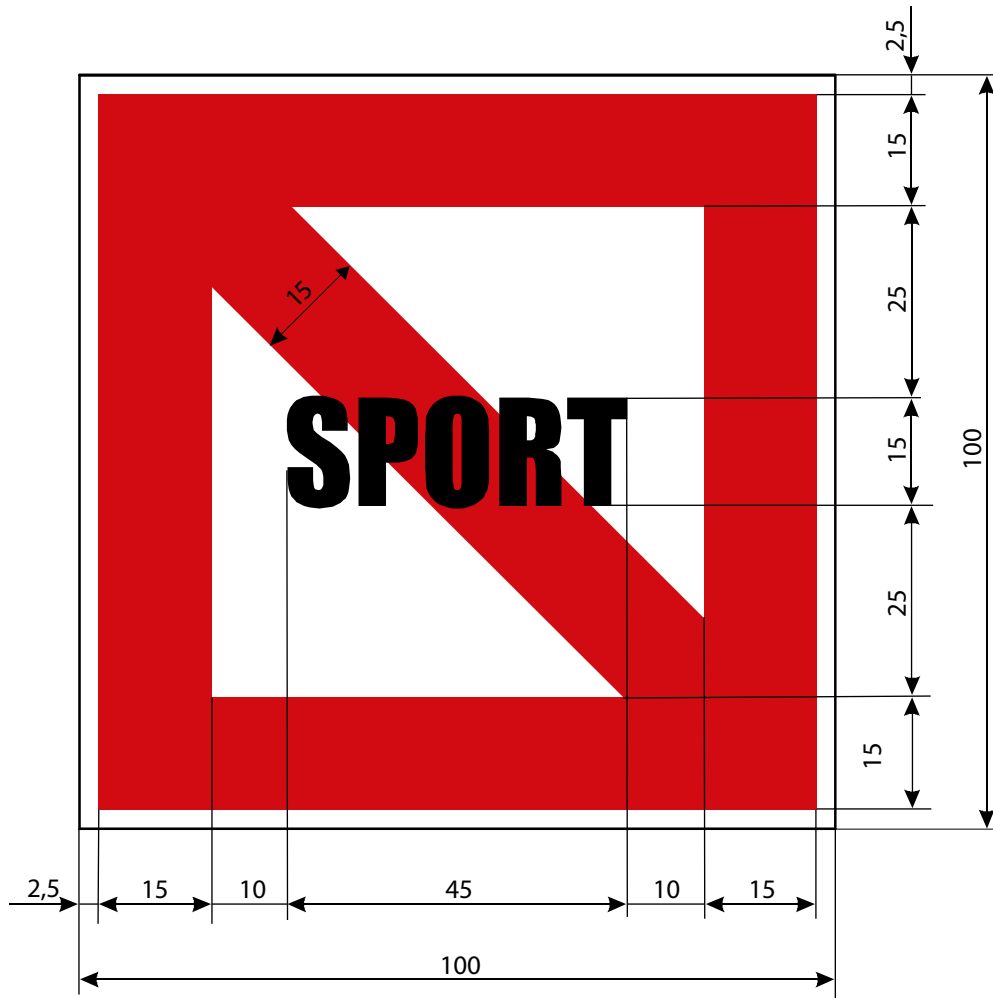
A.10 No passing outside the area marked (in openings of bridges or weirs)



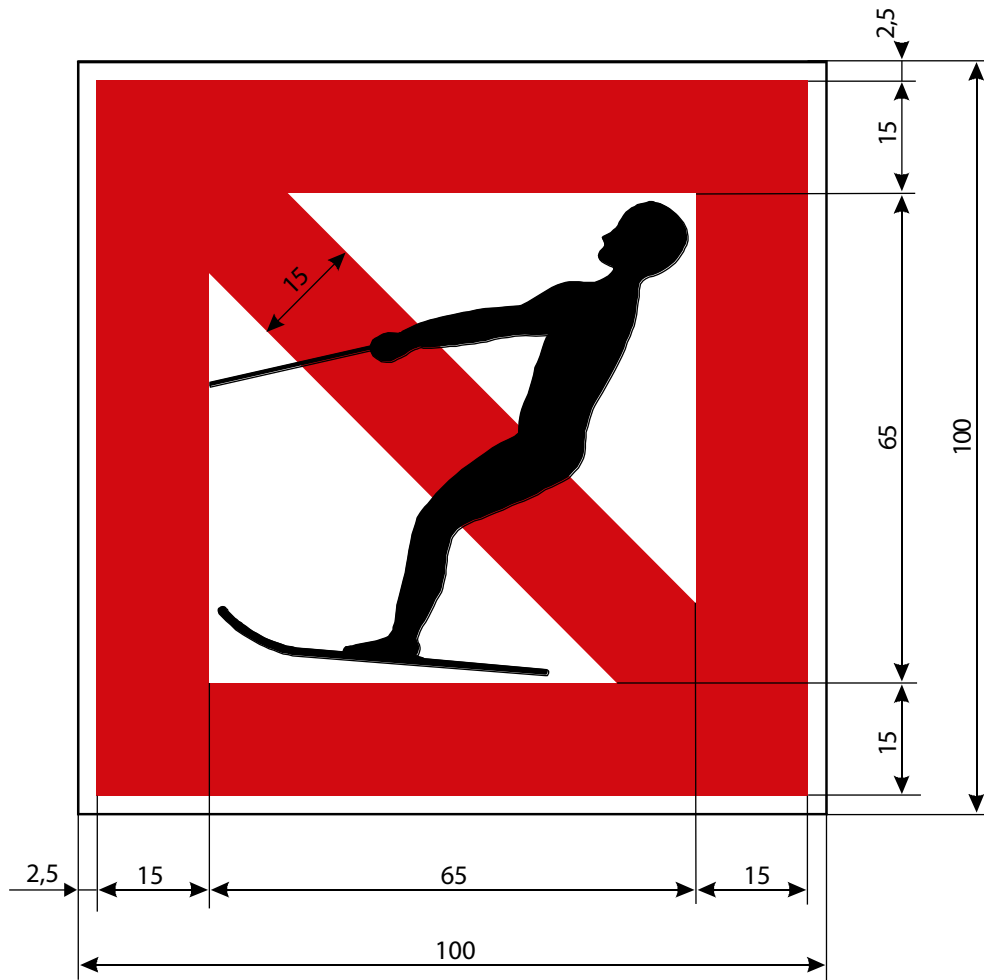
A.12 Motorized craft prohibited



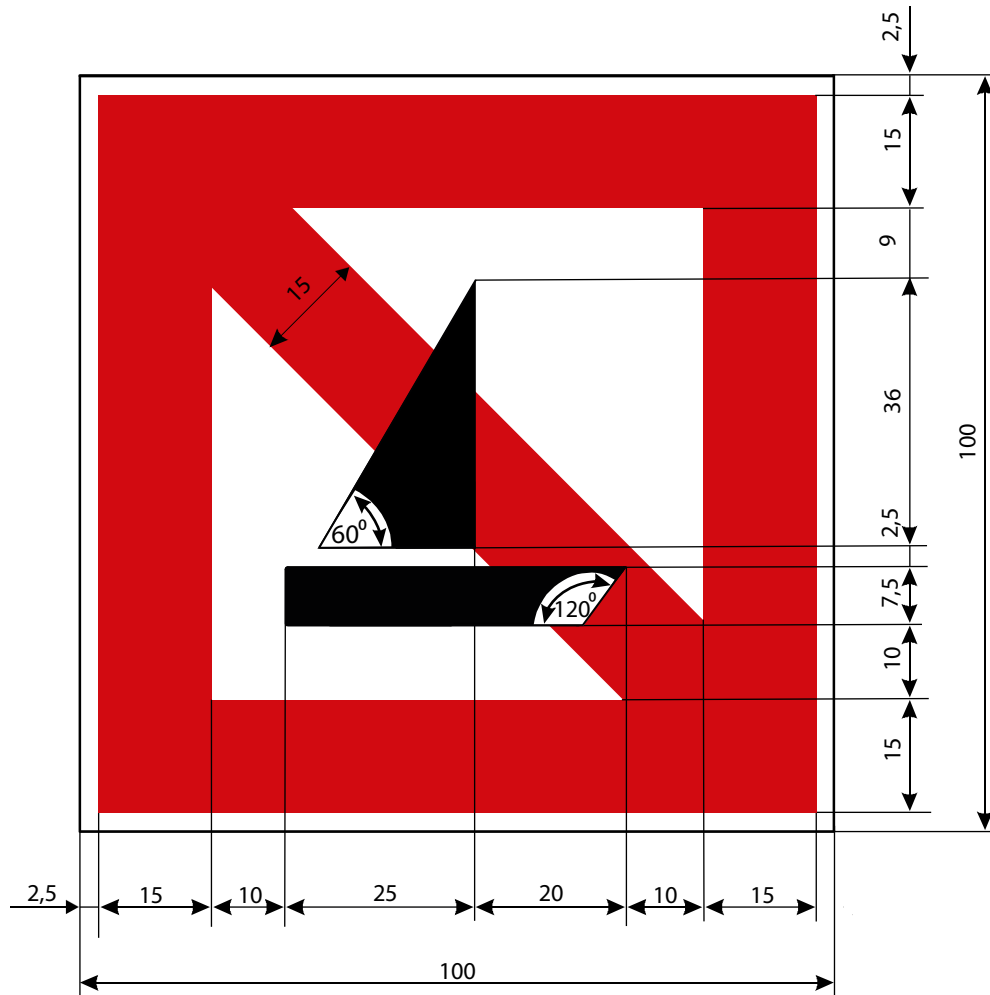
A.13 Sports or pleasure craft prohibited



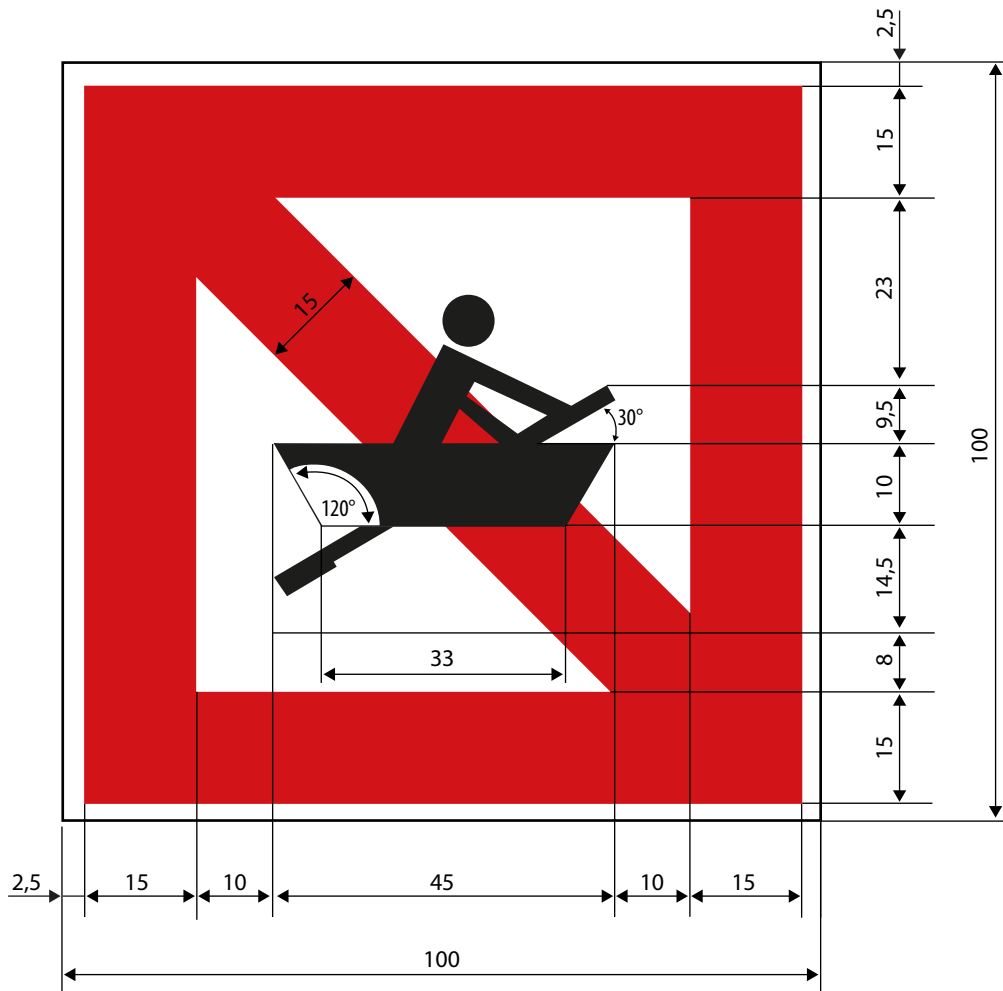
A.14 Water skiing prohibited



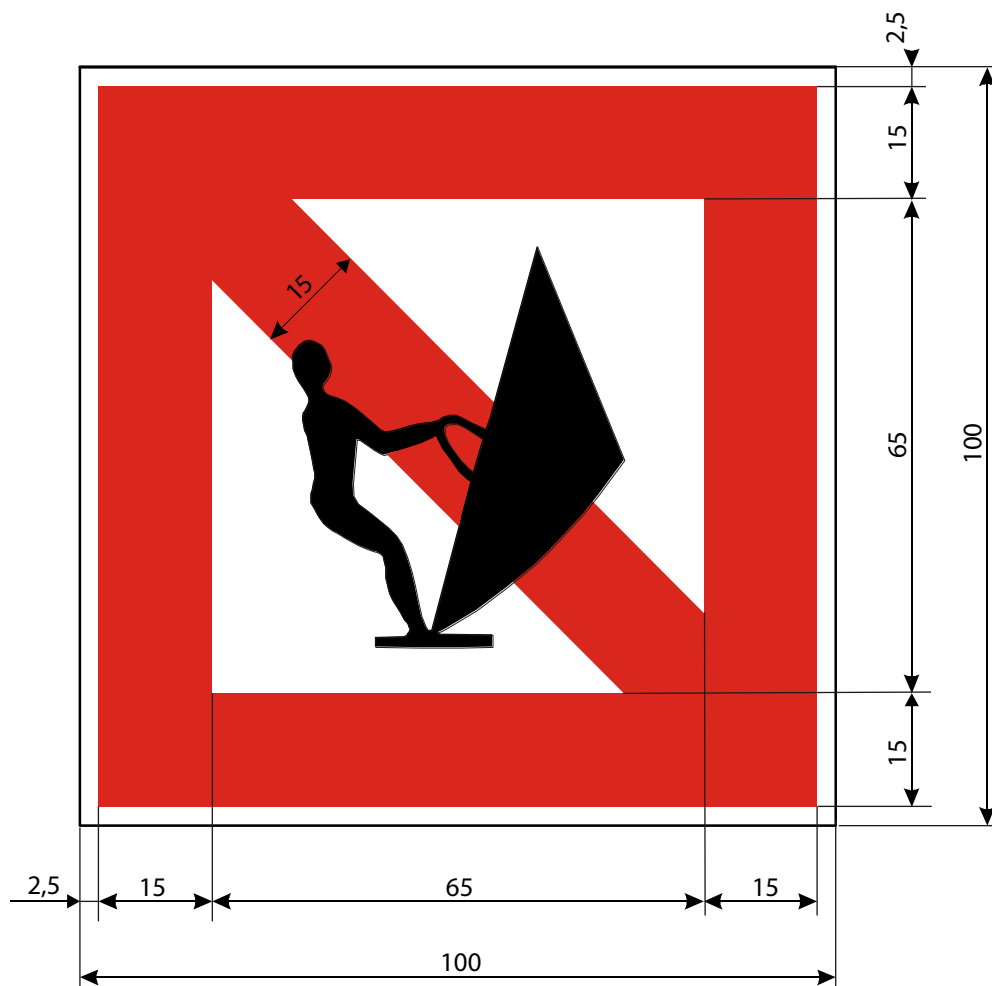
A.15 Sailing vessels prohibited



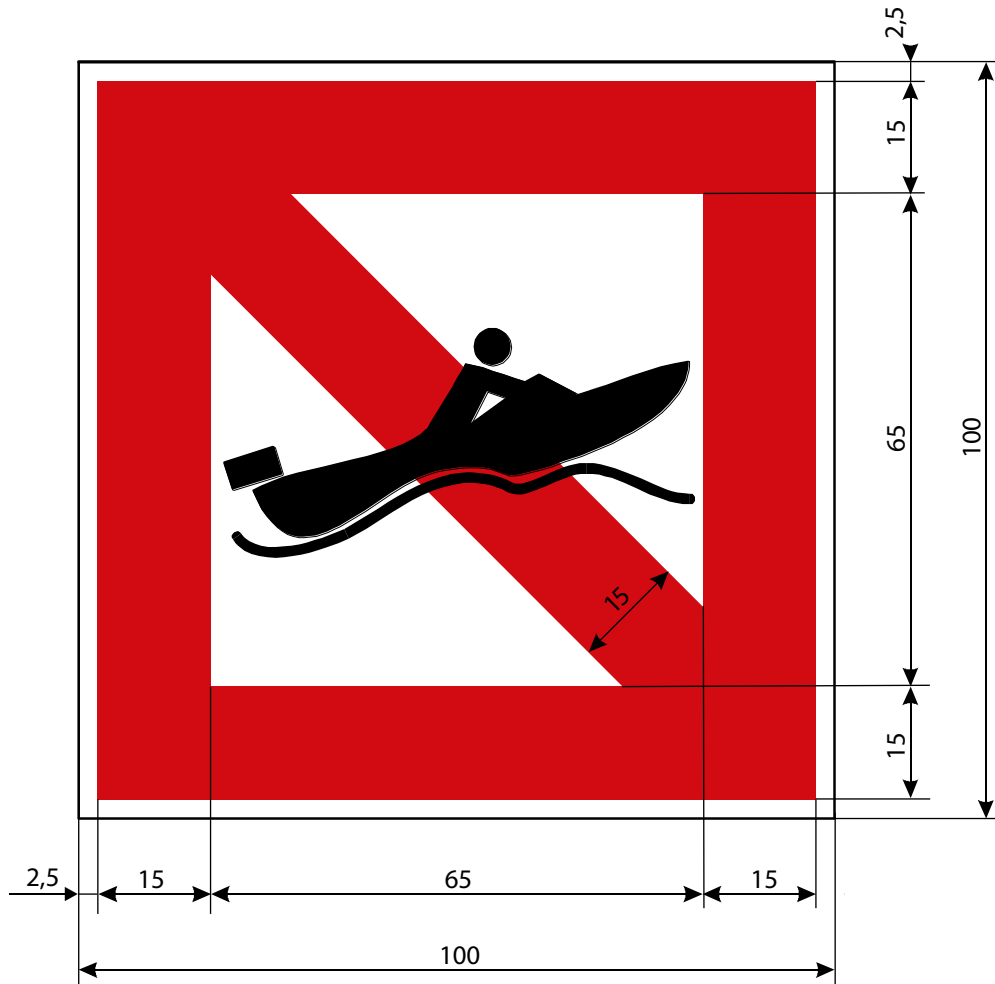
A.16 All craft other than motorized vessels or sailing craft prohibited



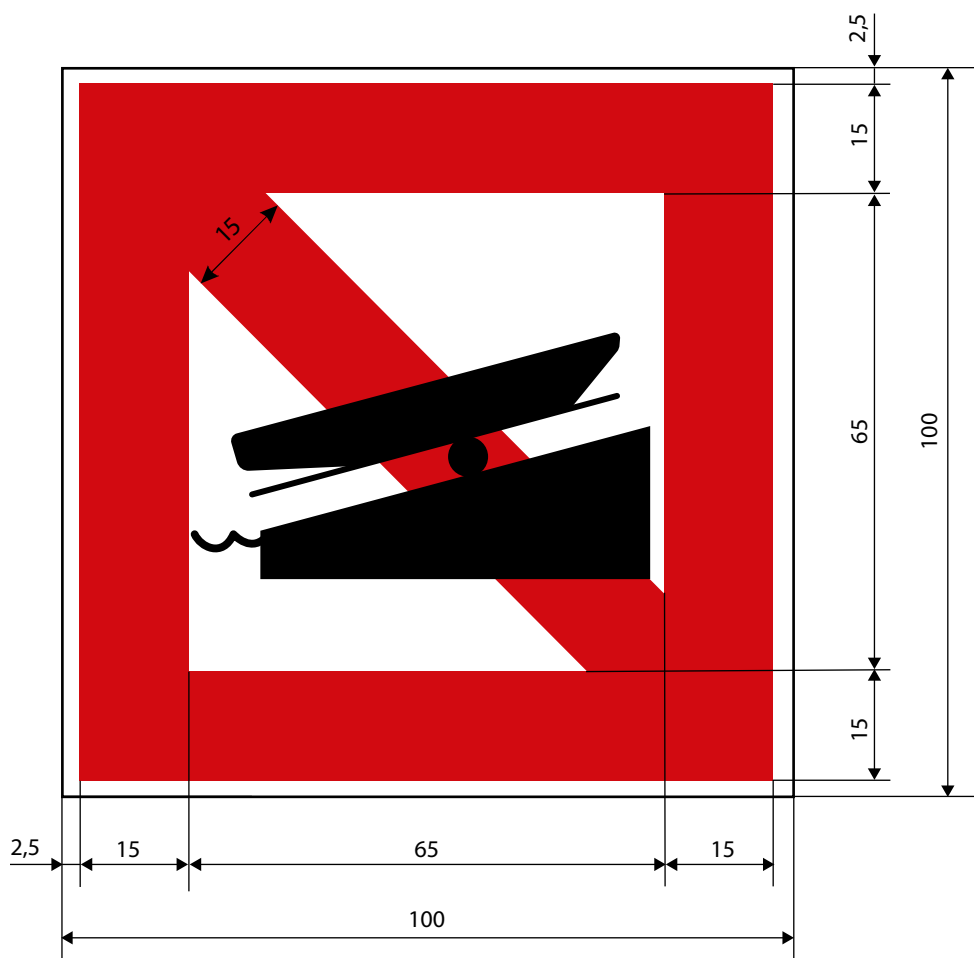
A.17 Use of sailboards prohibited



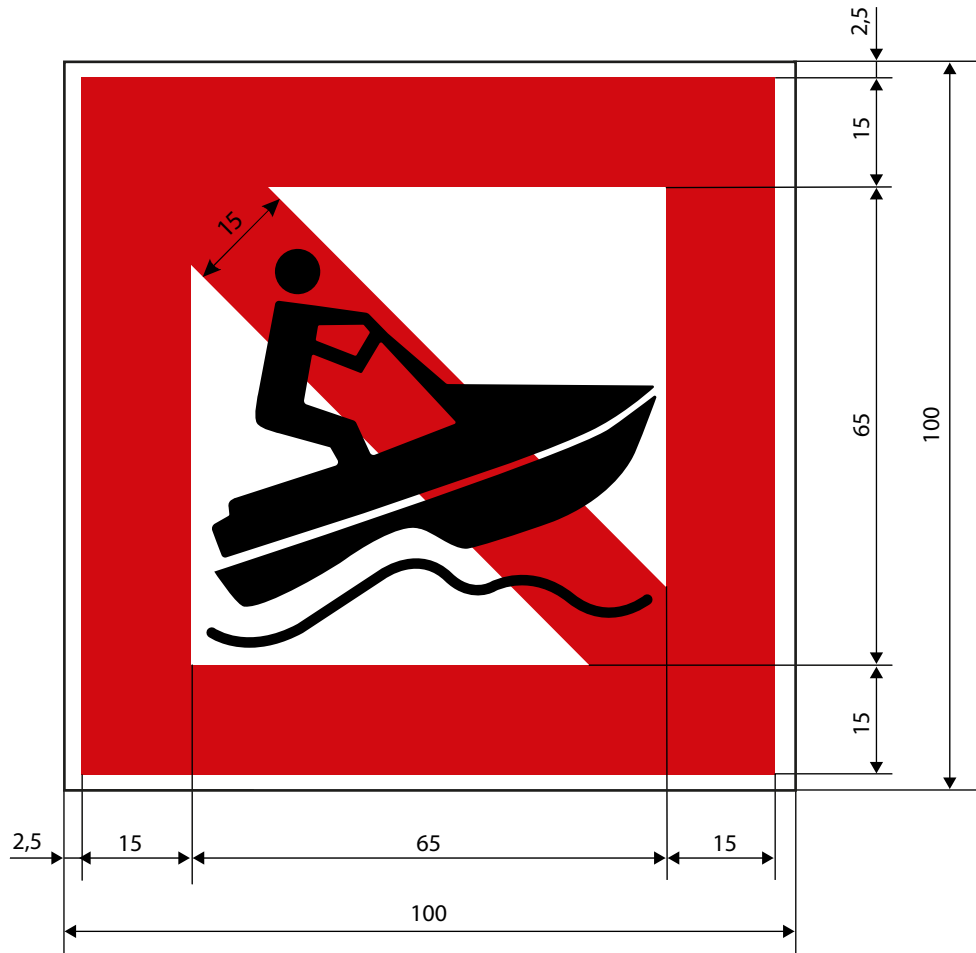
A.18 End of zone authorized for high speed navigation of small sport and pleasure craft



A.19 No launching or beaching of vessels

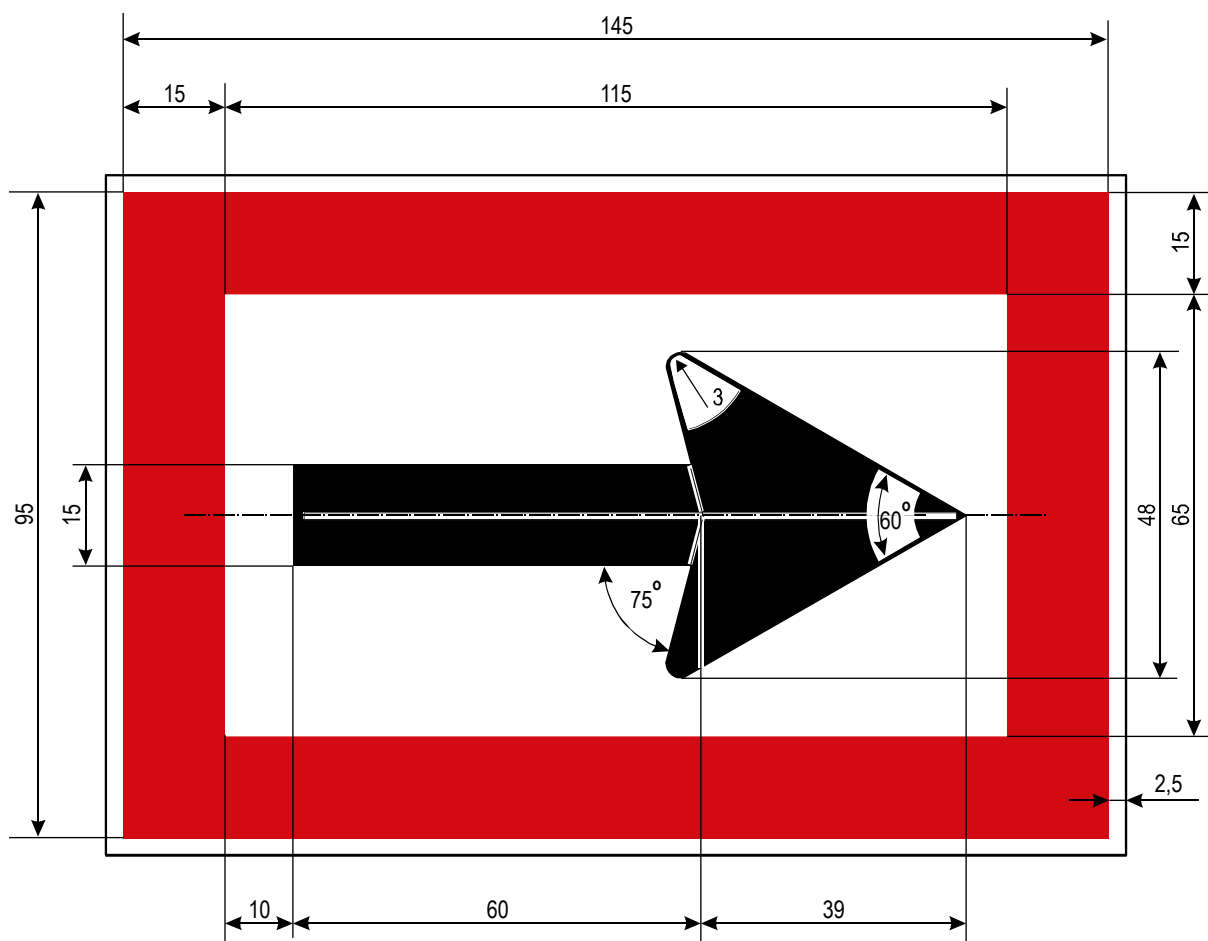


A.20 Water bikes prohibited

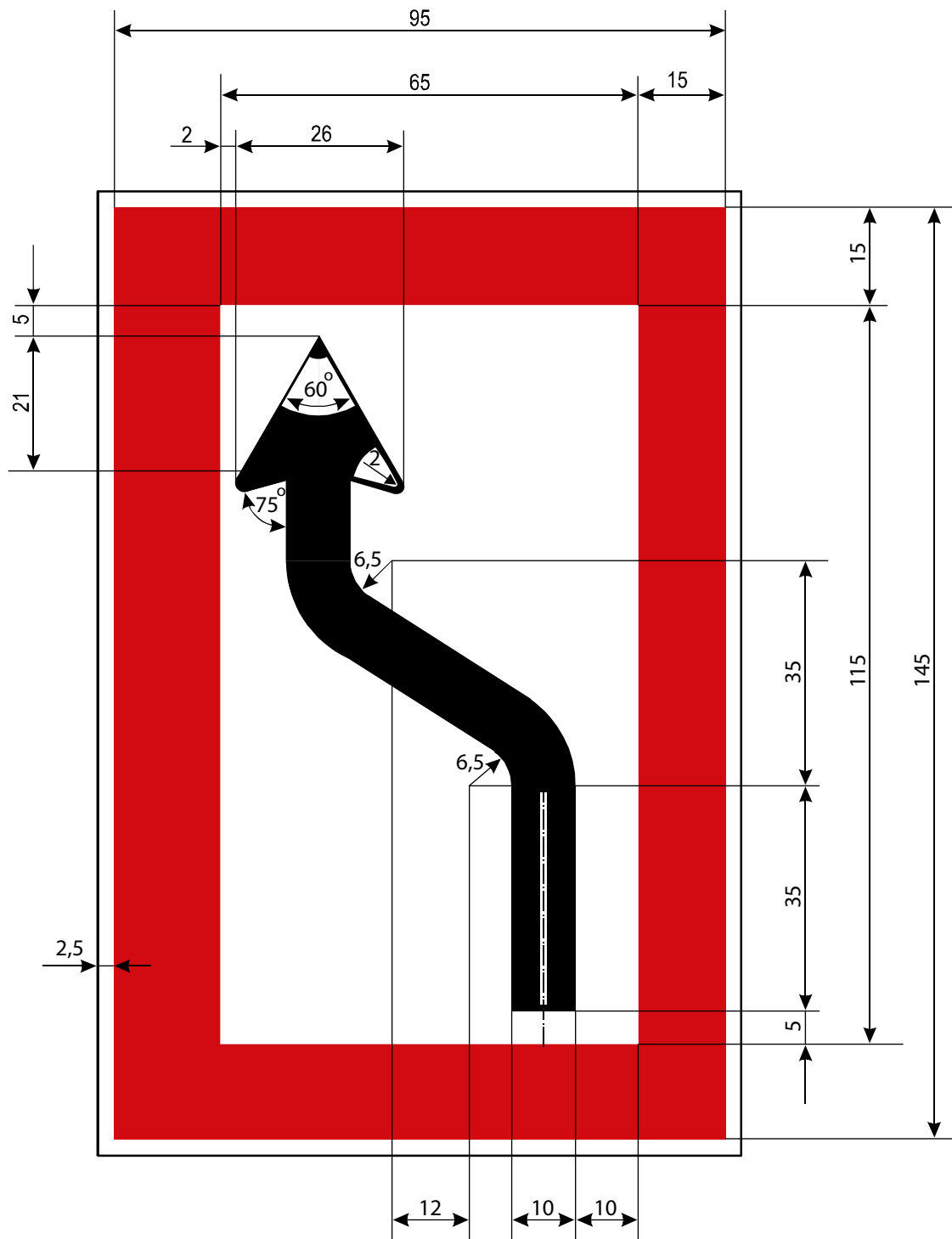


B. Mandatory signs

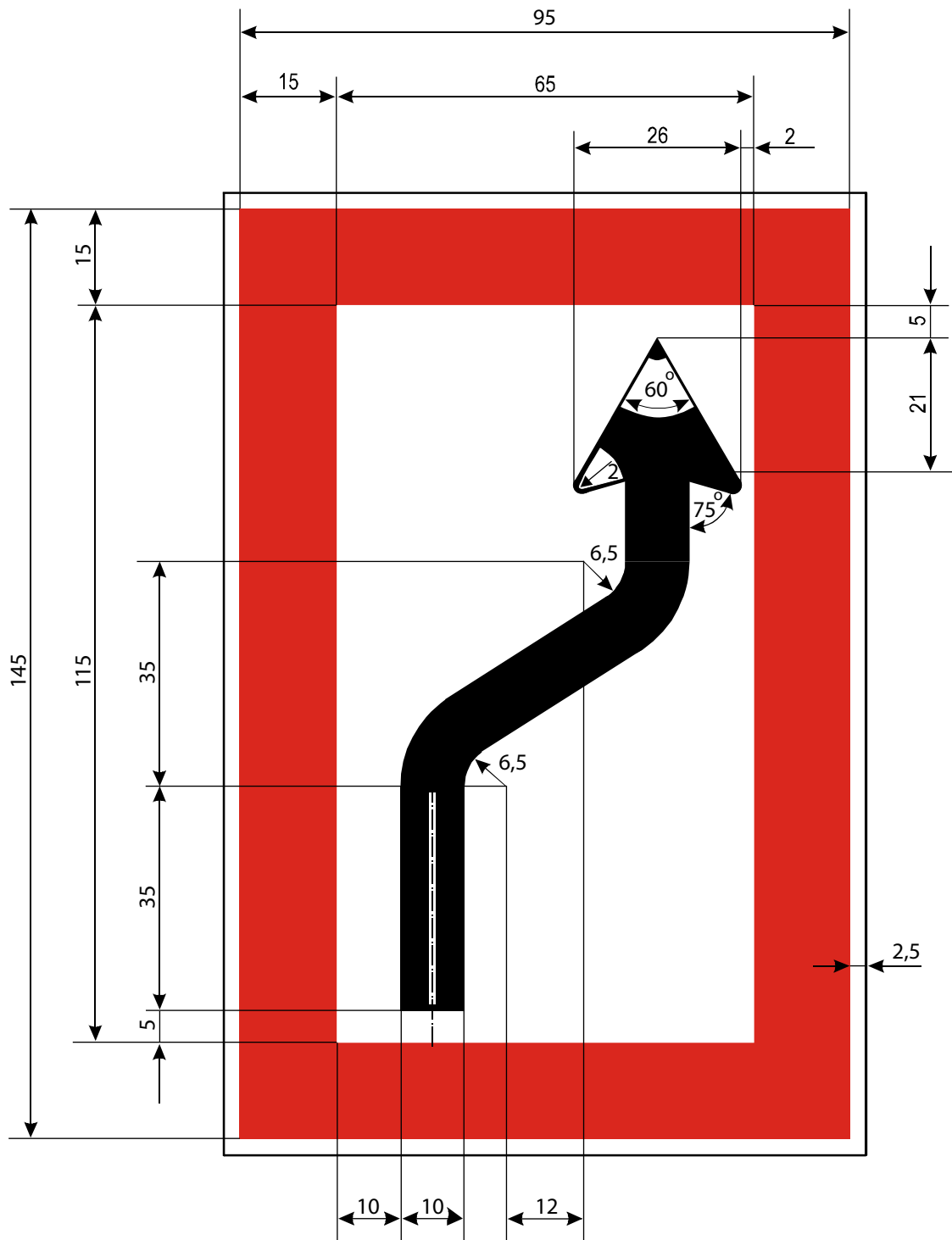
B.1 Proceed in the direction shown by the arrow



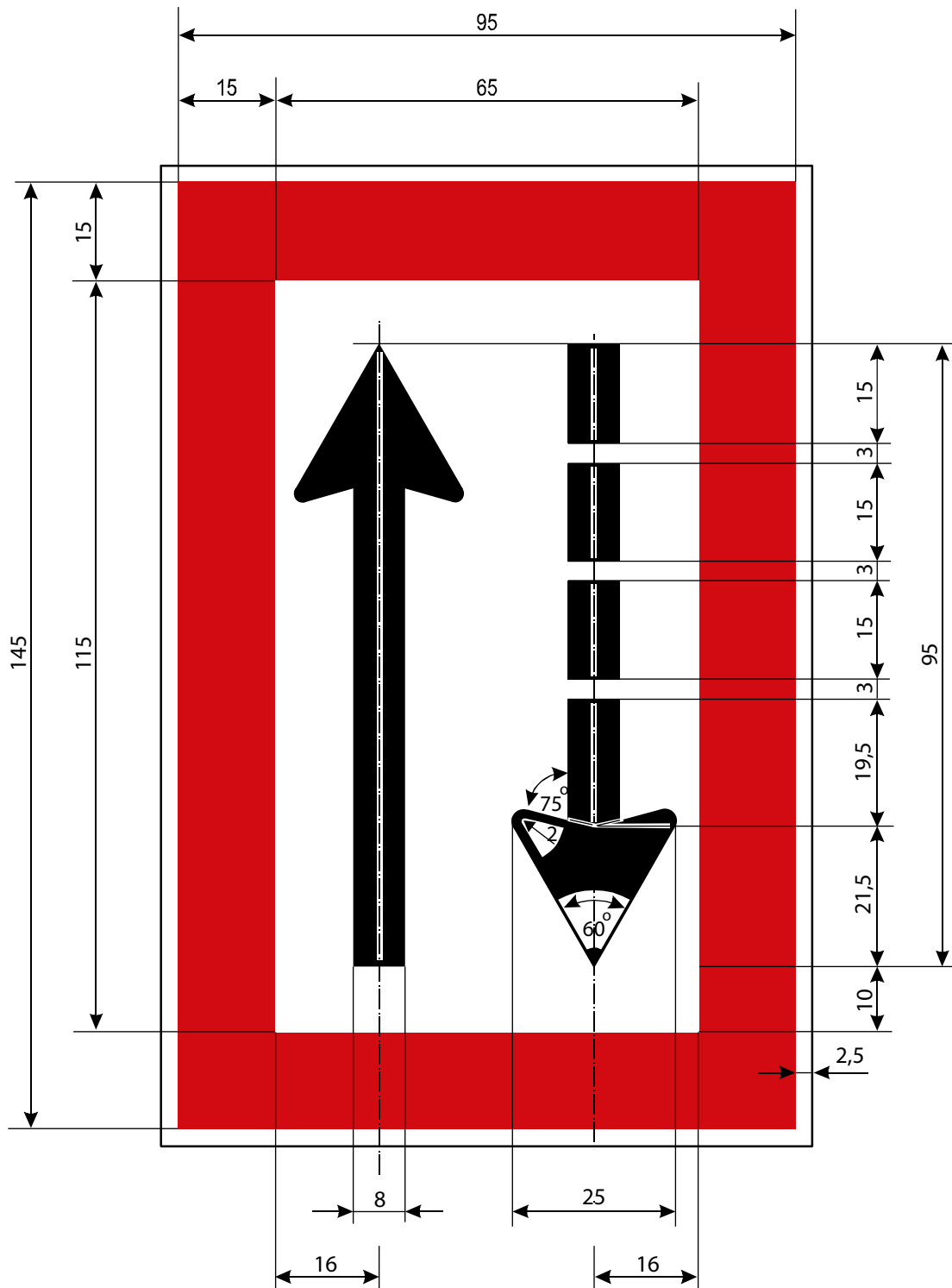
B.2a Move to the side of the fairway on your port side



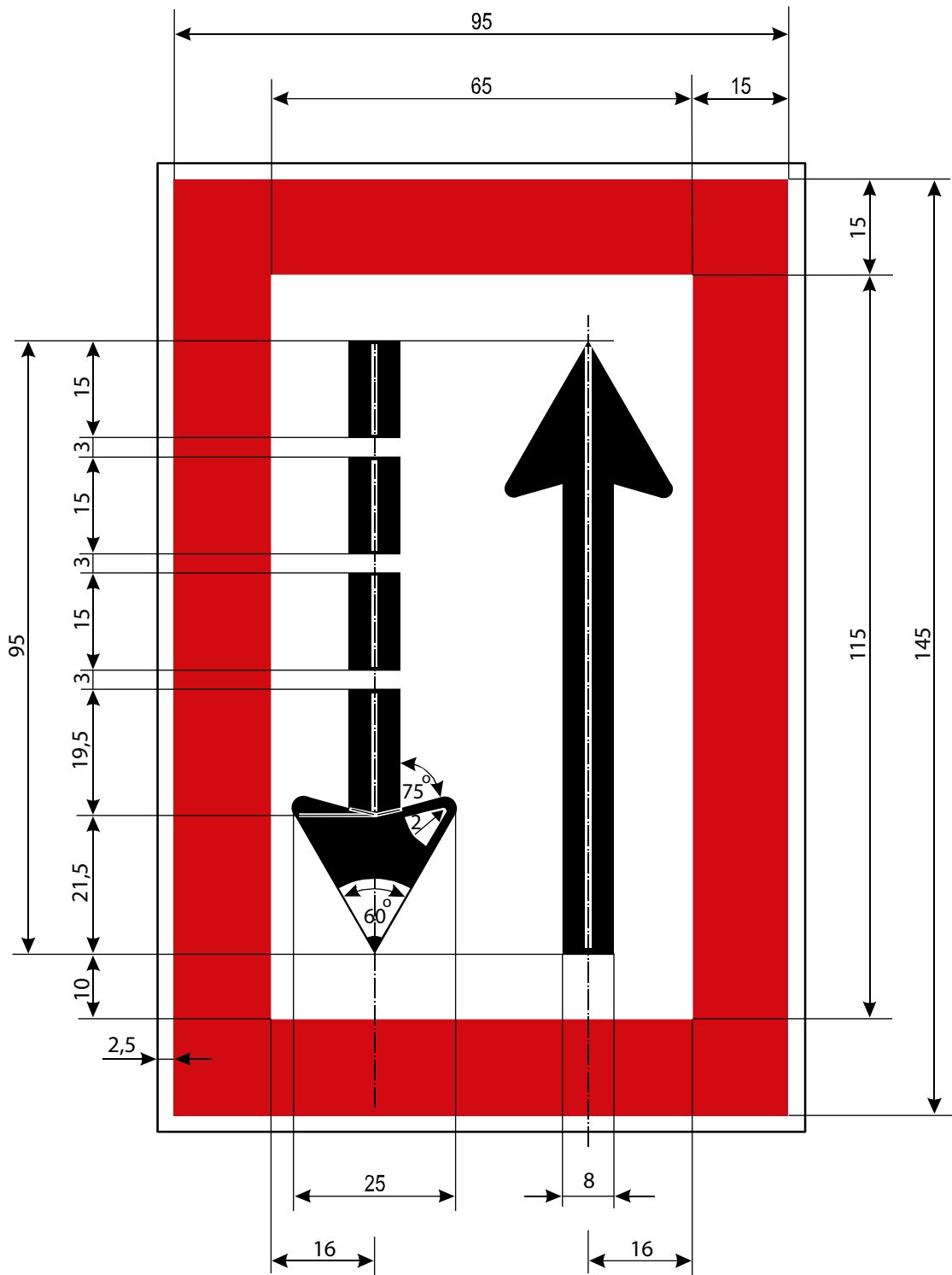
B.2b Move to the side of the fairway on your starboard side



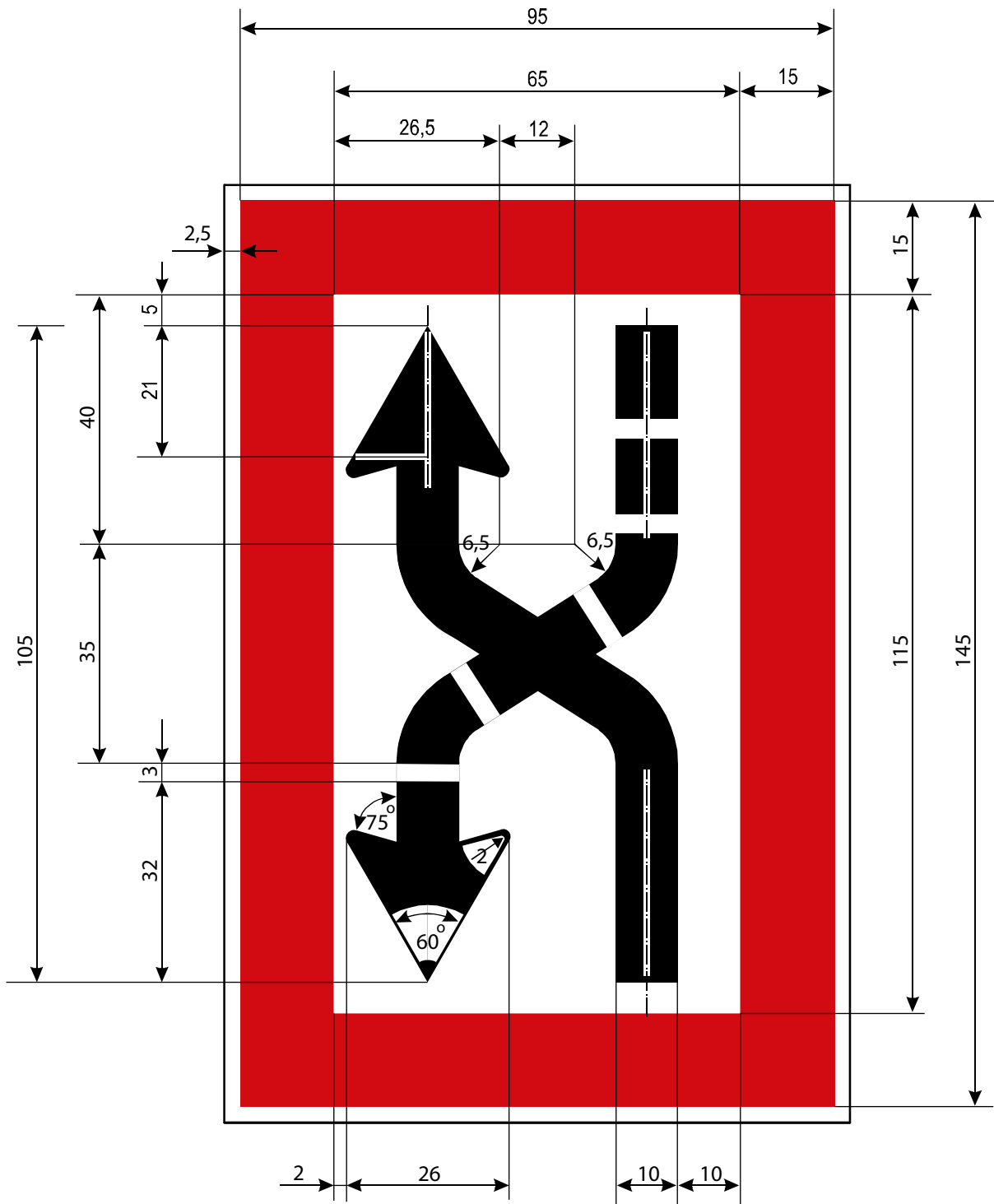
B.3a Keep to the side of the fairway on your port side



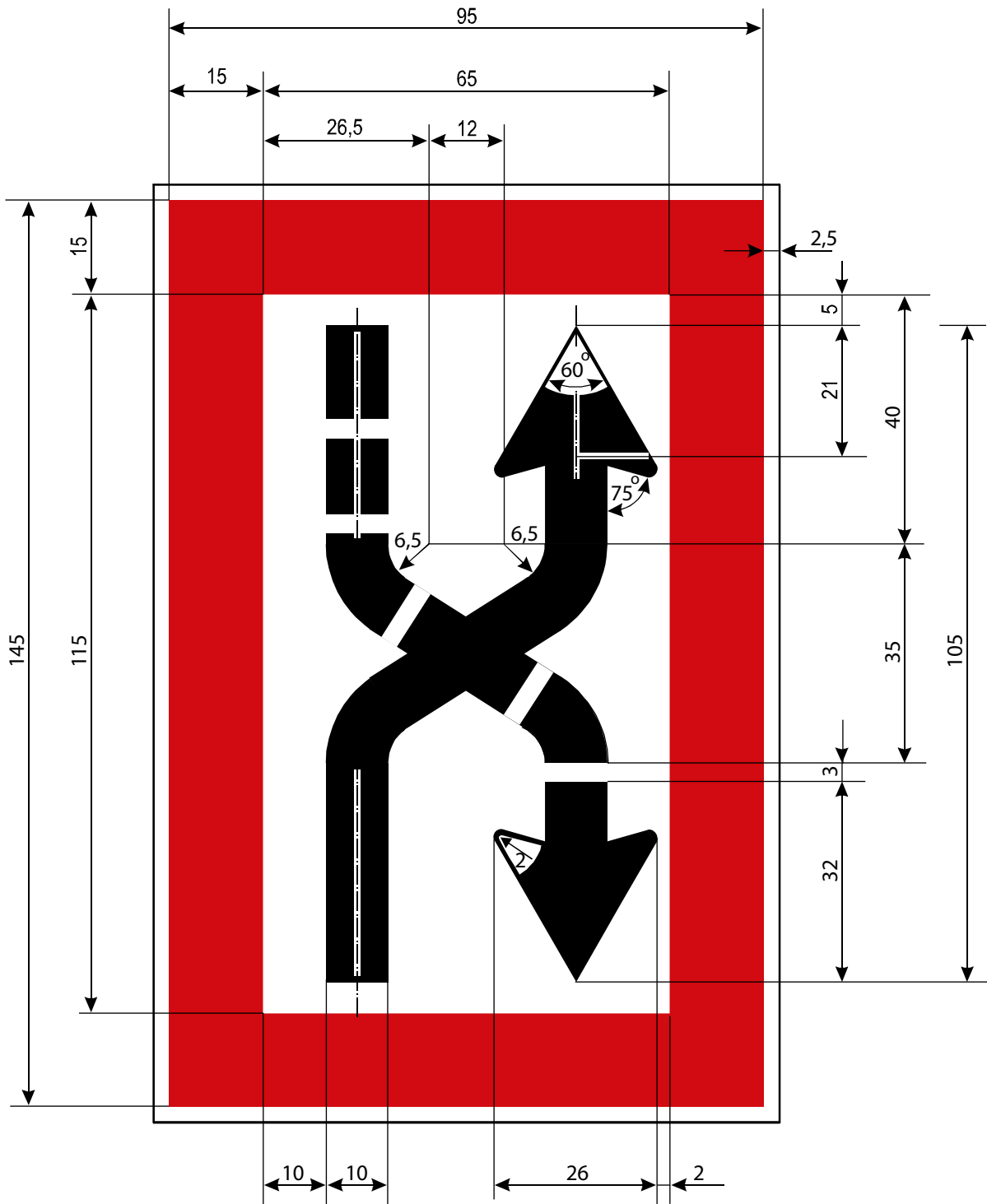
B.3b Keep to the side of the fairway on your starboard side



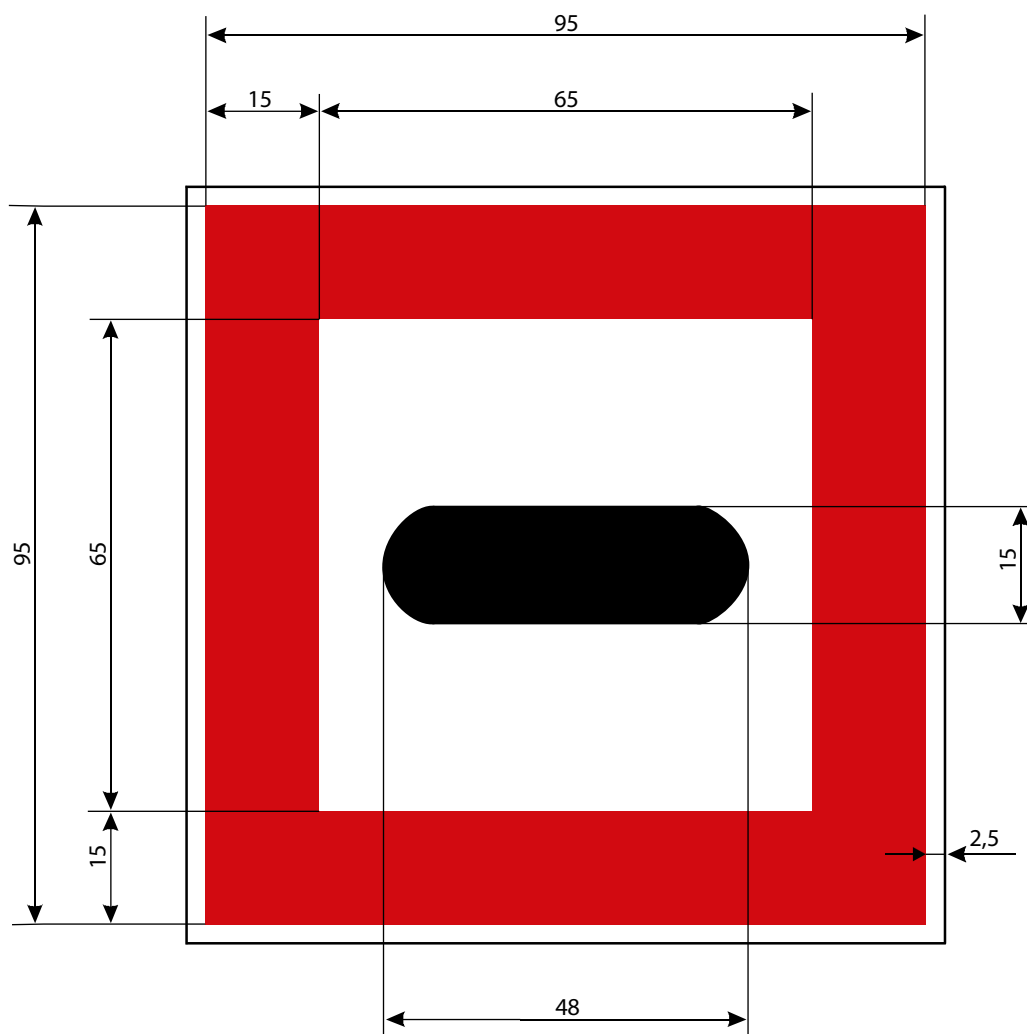
B.4a Cross fairway to port



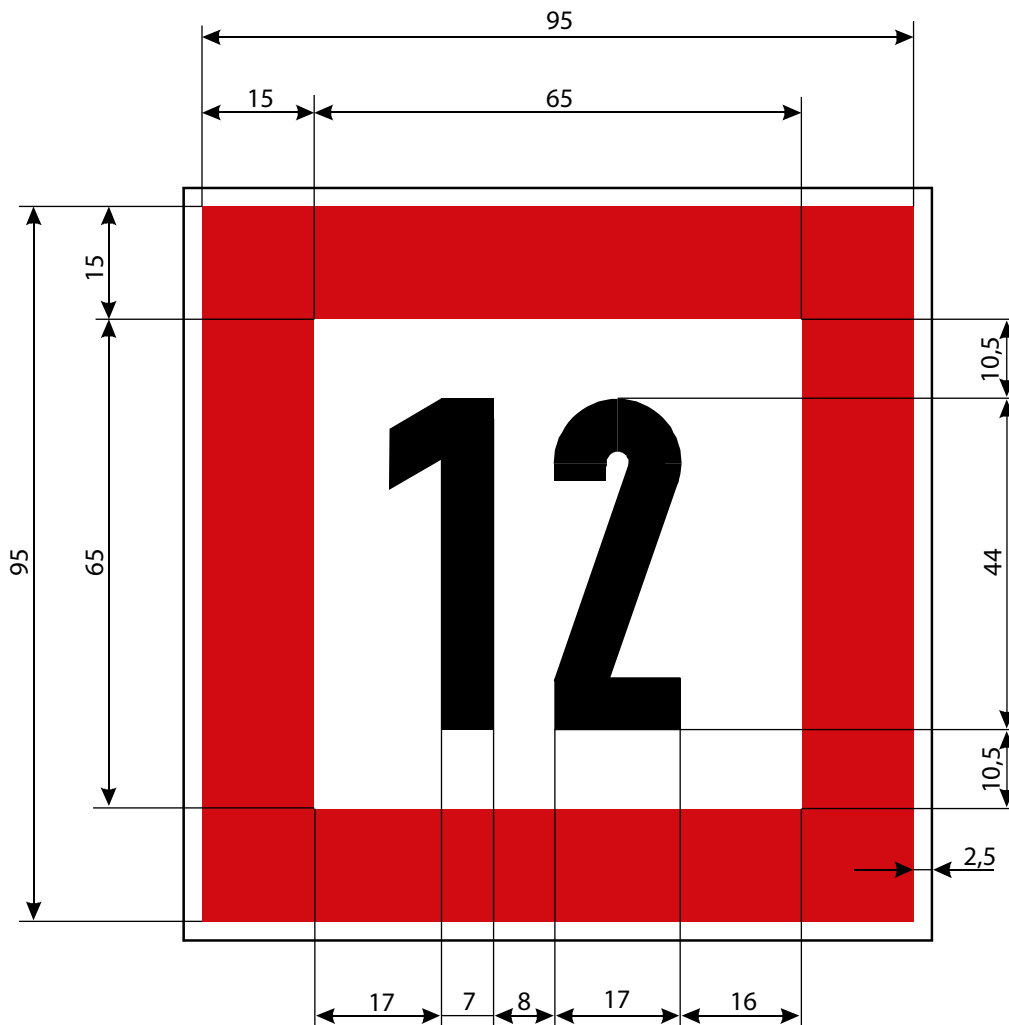
B.4b Cross fairway to starboard



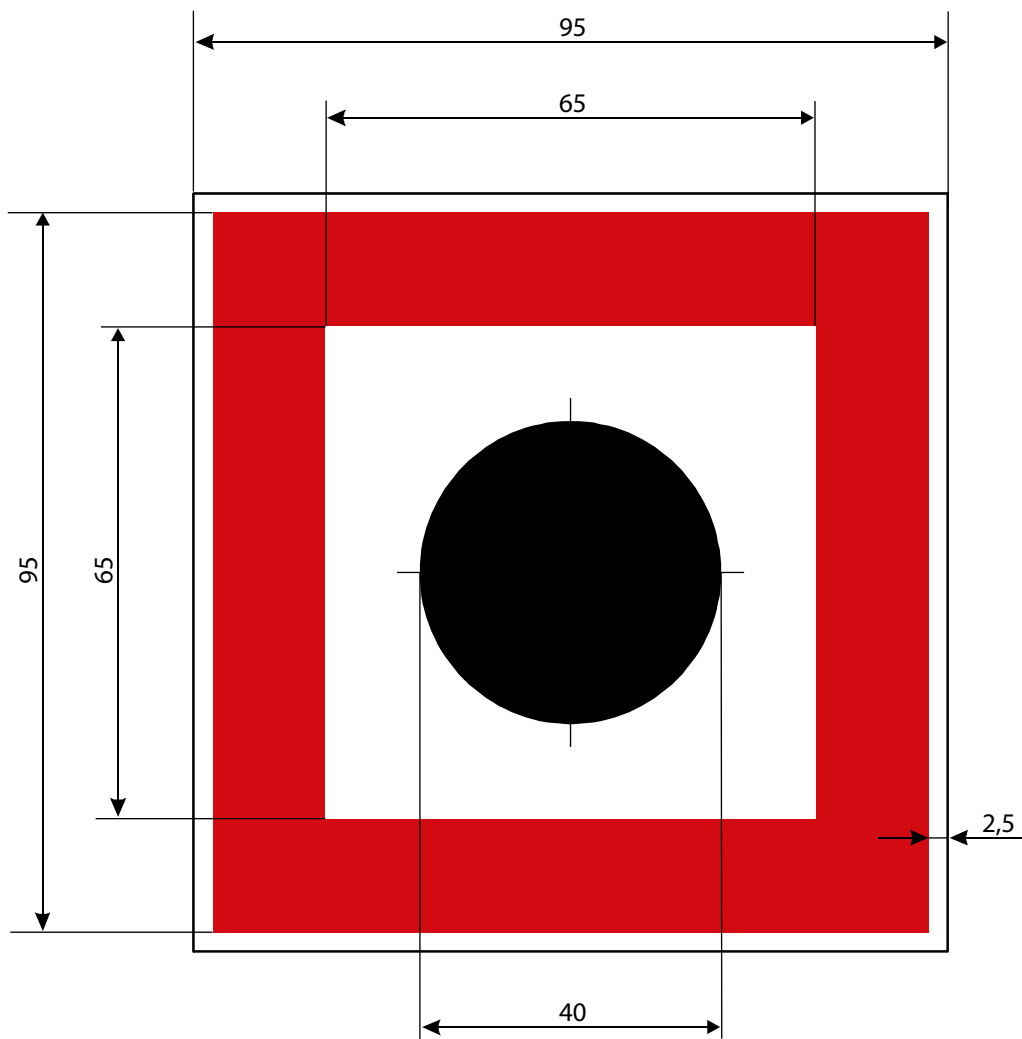
B.5 Stop as prescribed in the Regulations (see article 6.26, para. 2 and article 6.28, para. 1 of CEVNI)



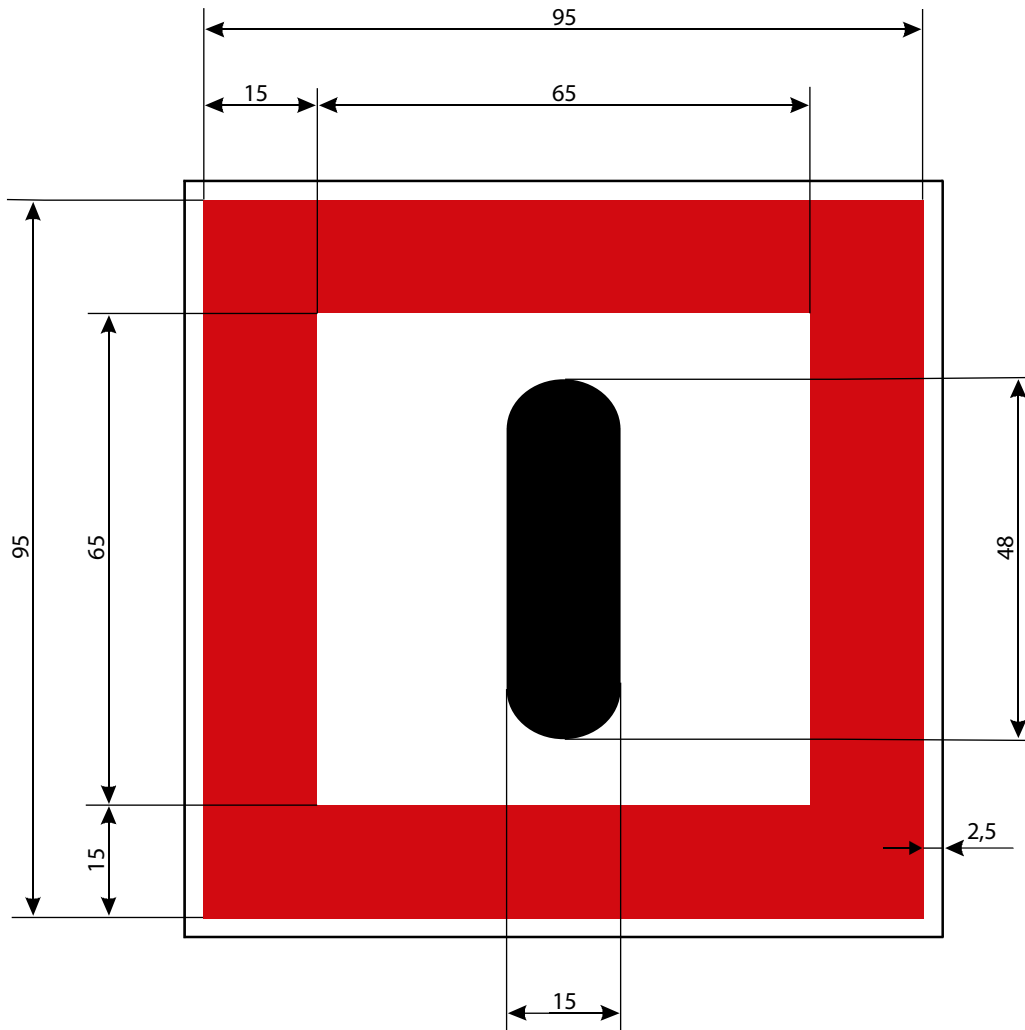
B.6 Do not exceed the speed indicated (in km/h)



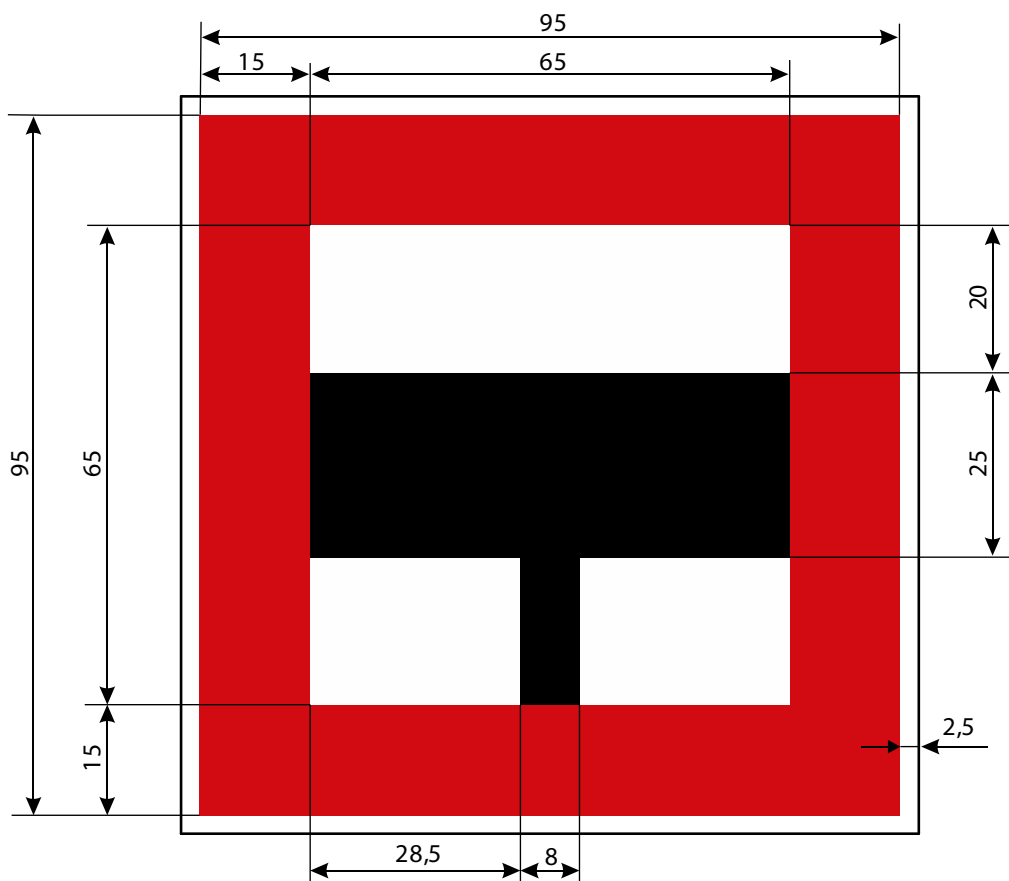
B.7 Give a sound signal



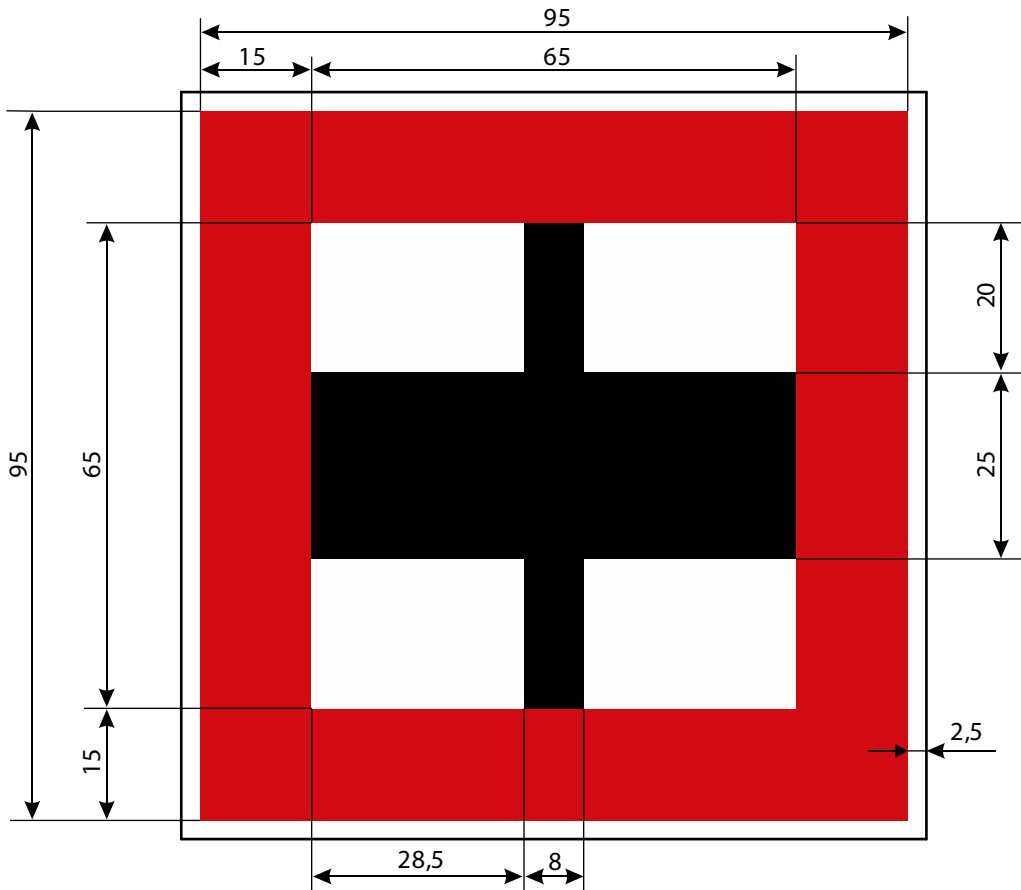
B.8 Keep a particularly sharp lookout



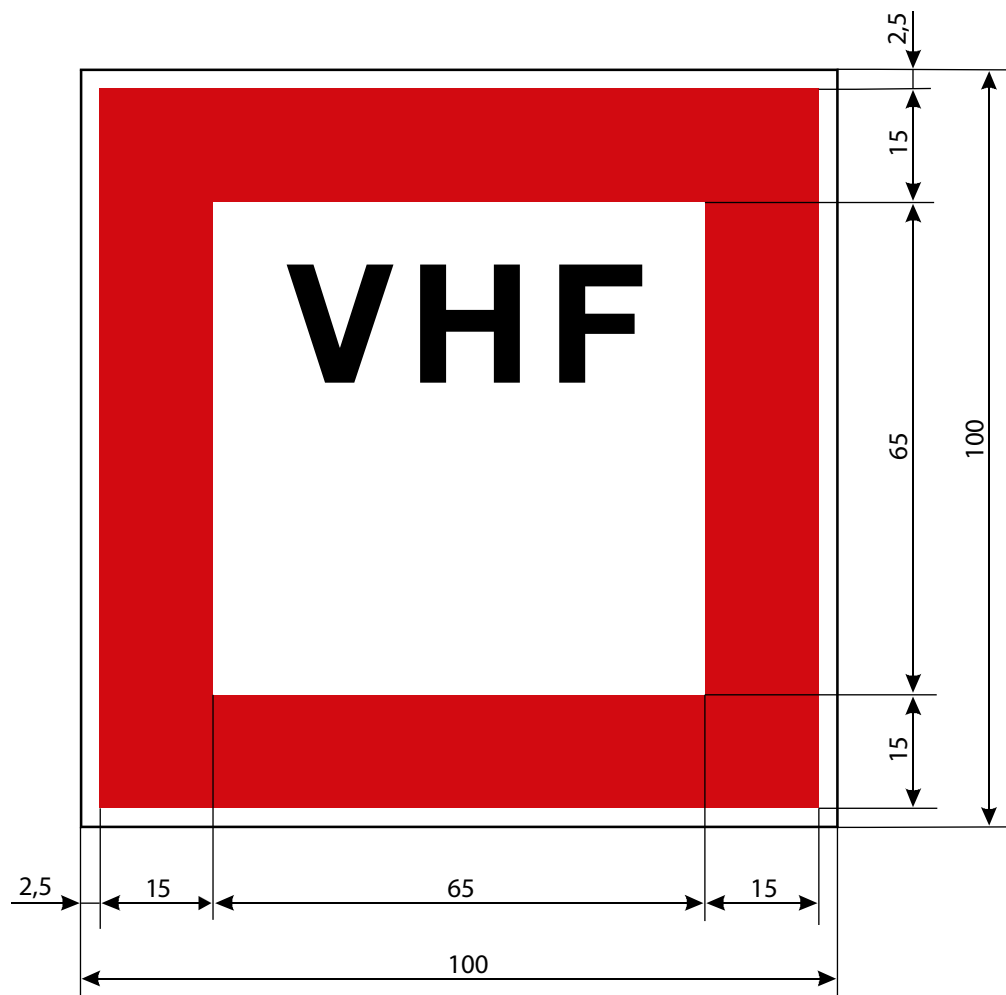
- B.9a Do not enter the main waterway until certain that this will not oblige vessels proceeding on it to change their course or speed



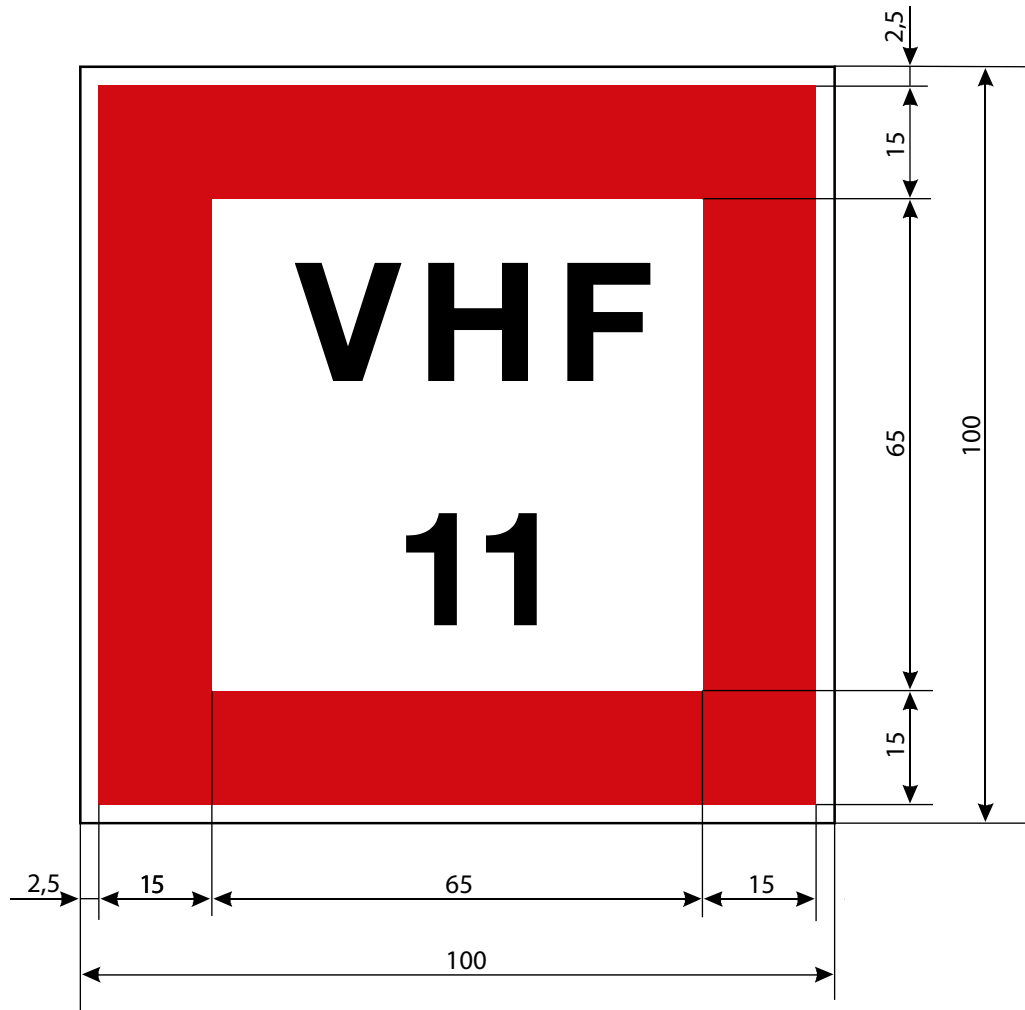
- B.9b Do not cross the main waterway until certain that this will not oblige vessels proceeding on it to change their course or speed



B.11a Obligation to enter into a radiotelephone link



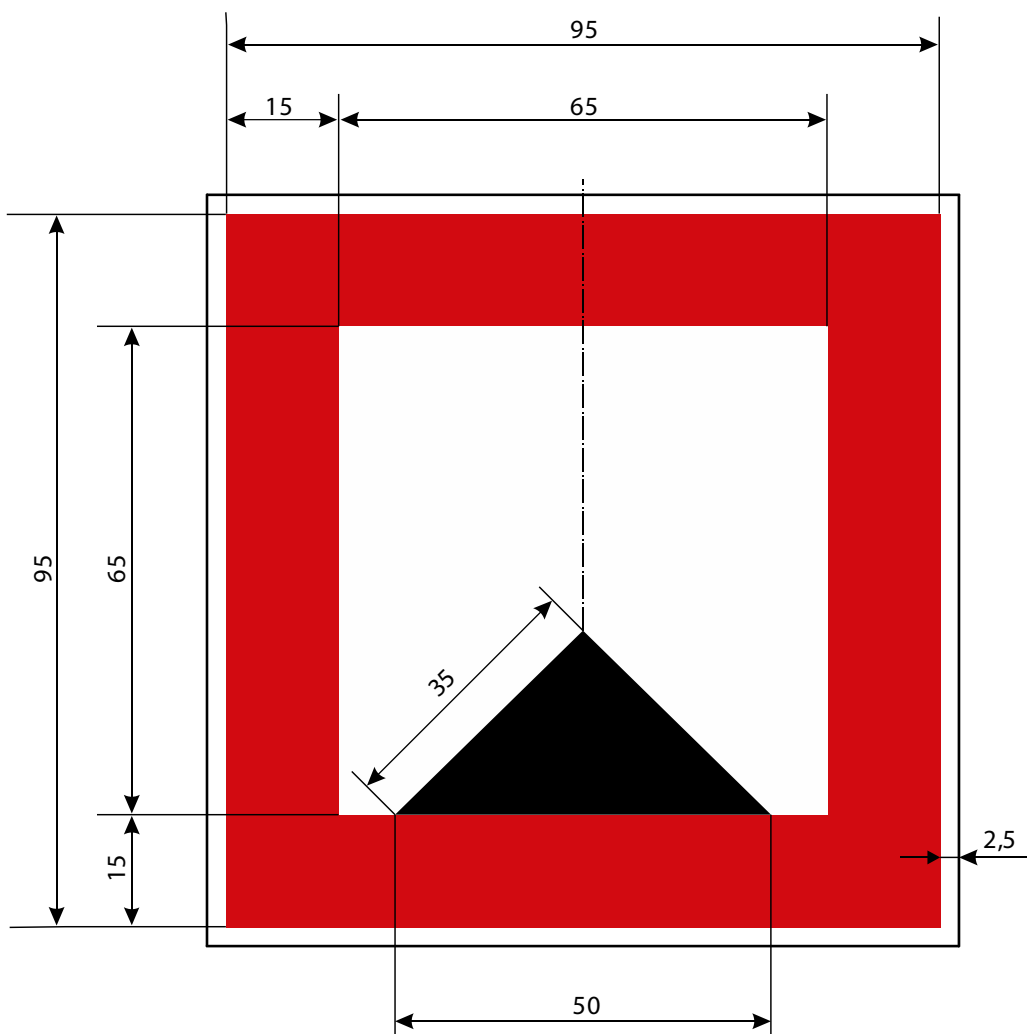
B.11b Obligation to enter into a radiotelephone link on the channel as indicated on the board



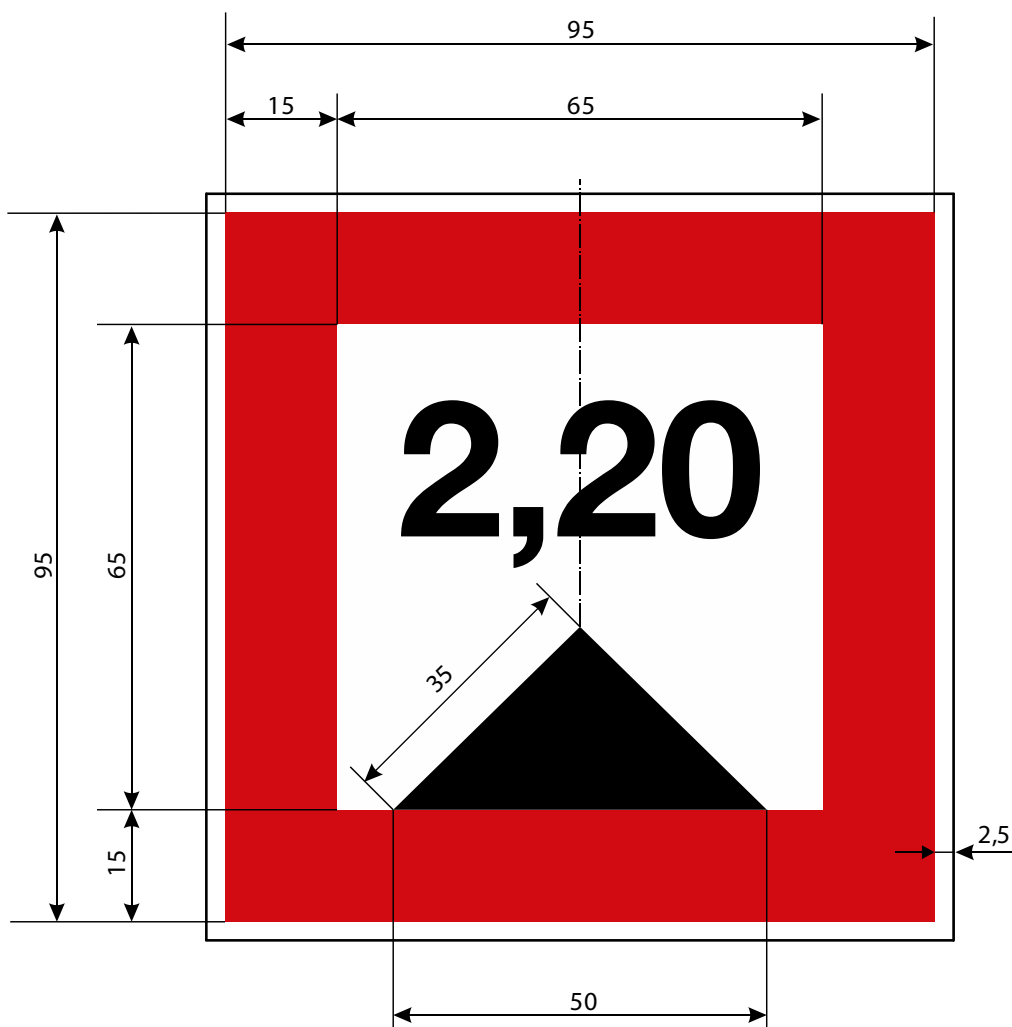
C. Restrictive signs

C.1 Depth of water limited

(a) C.1a

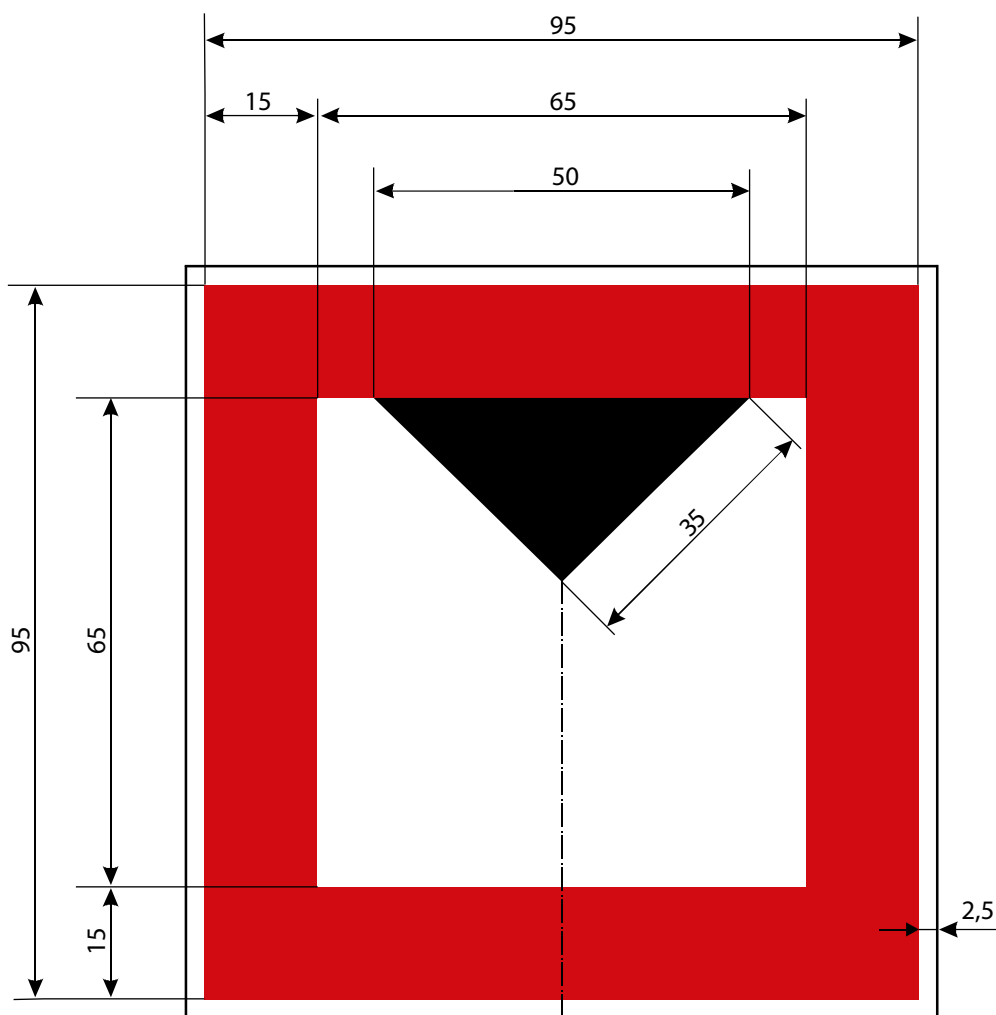


(b) C.1b

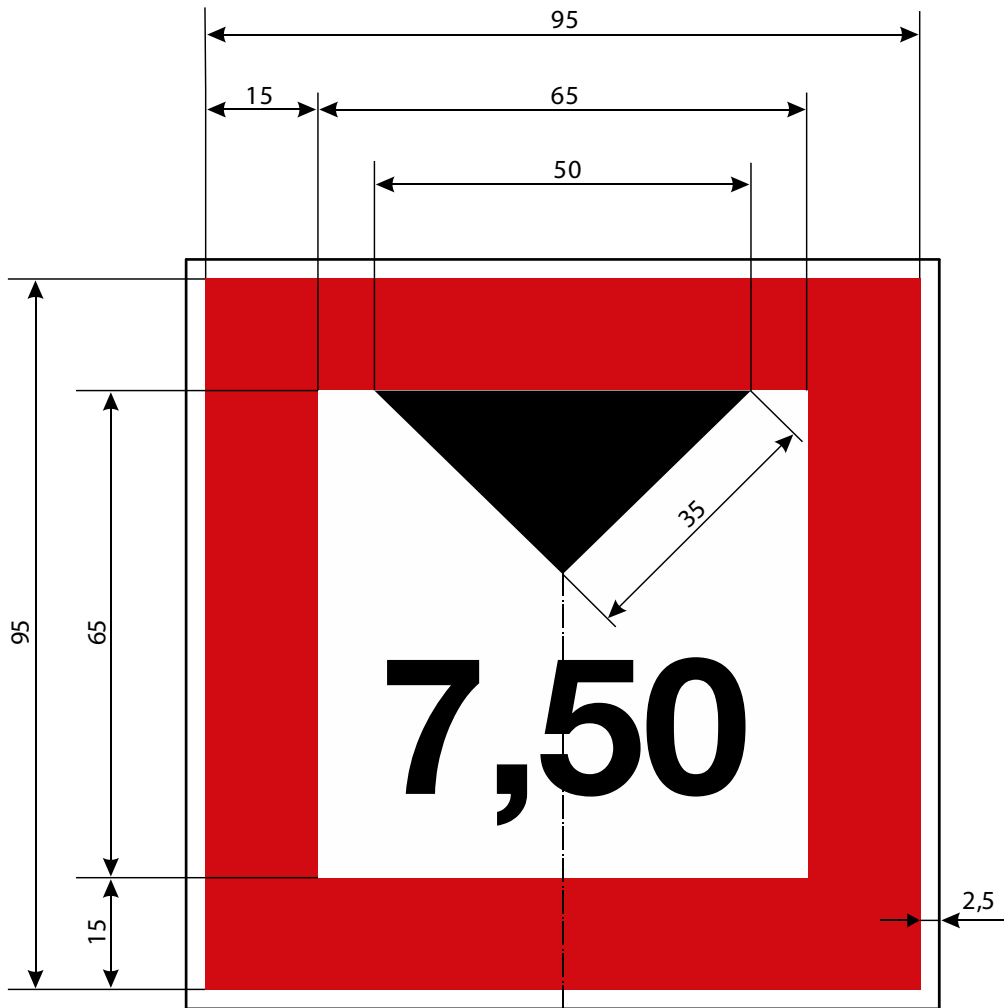


C.2 Headroom limited

(a) C.2a

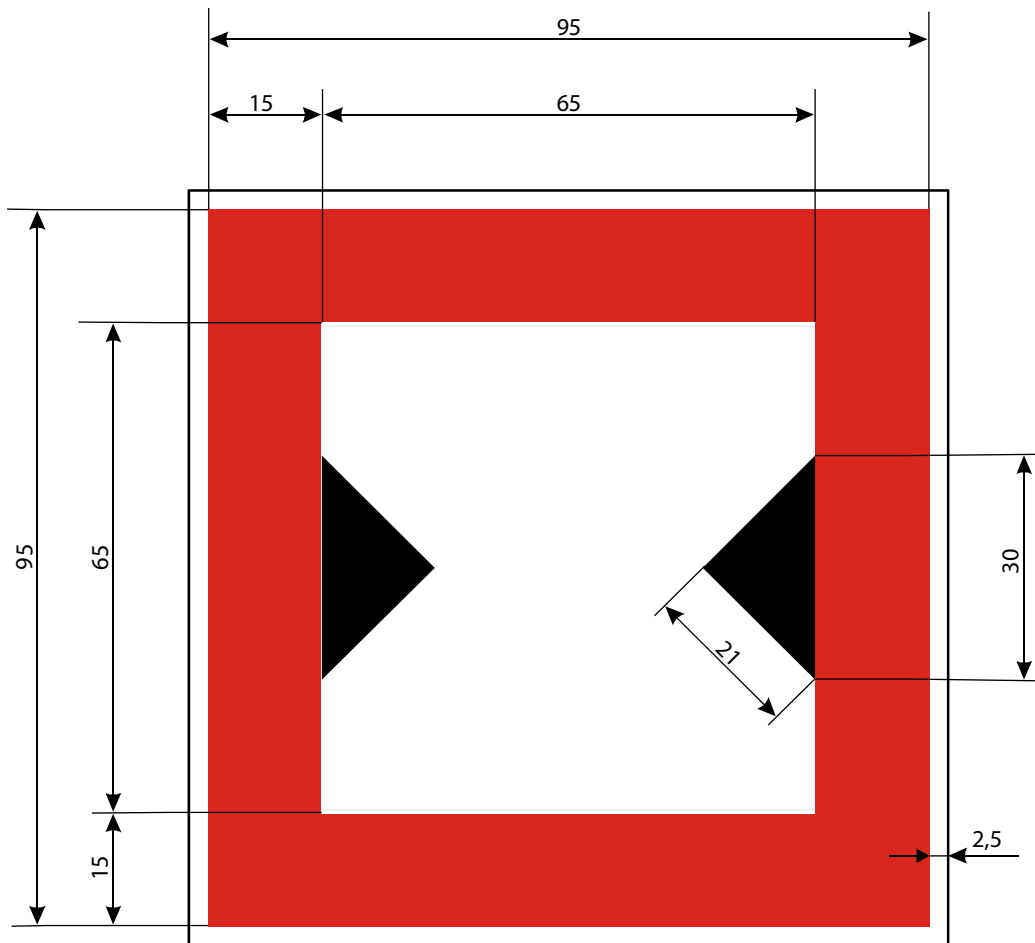


(b) C.2b

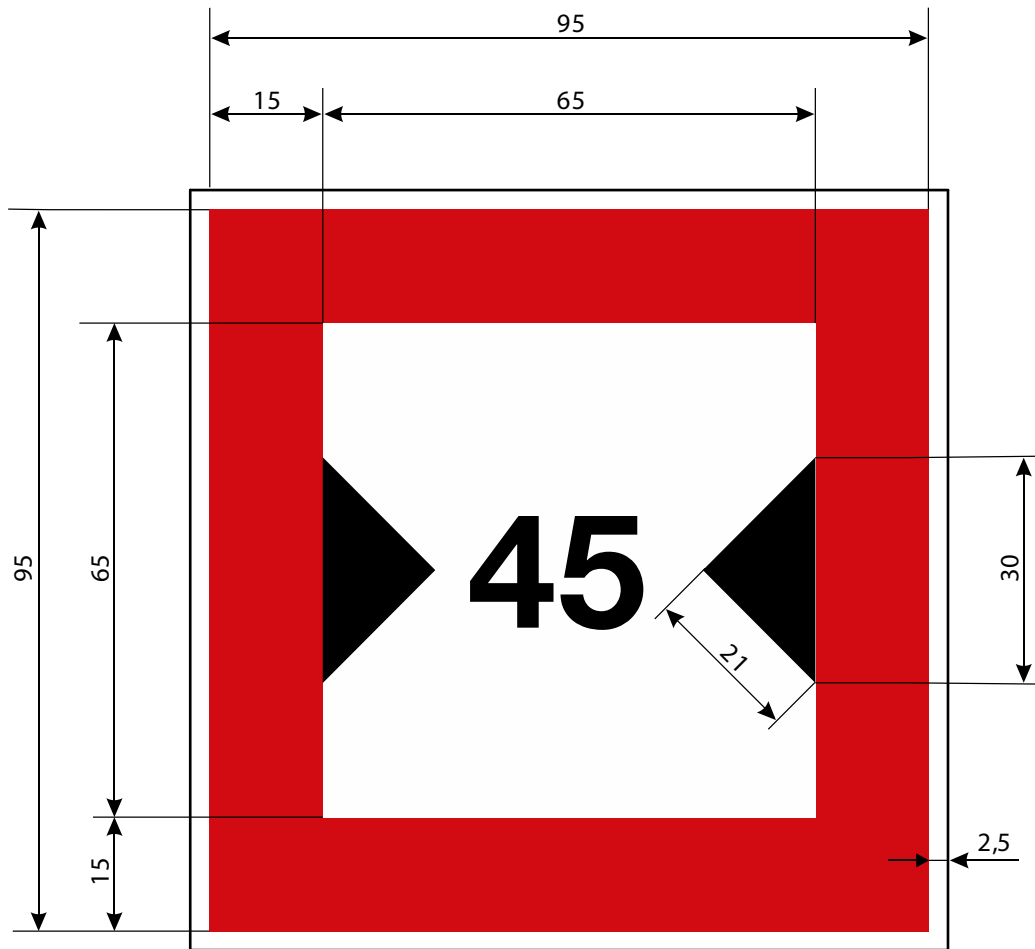


C.3 Width of passage or channel limited

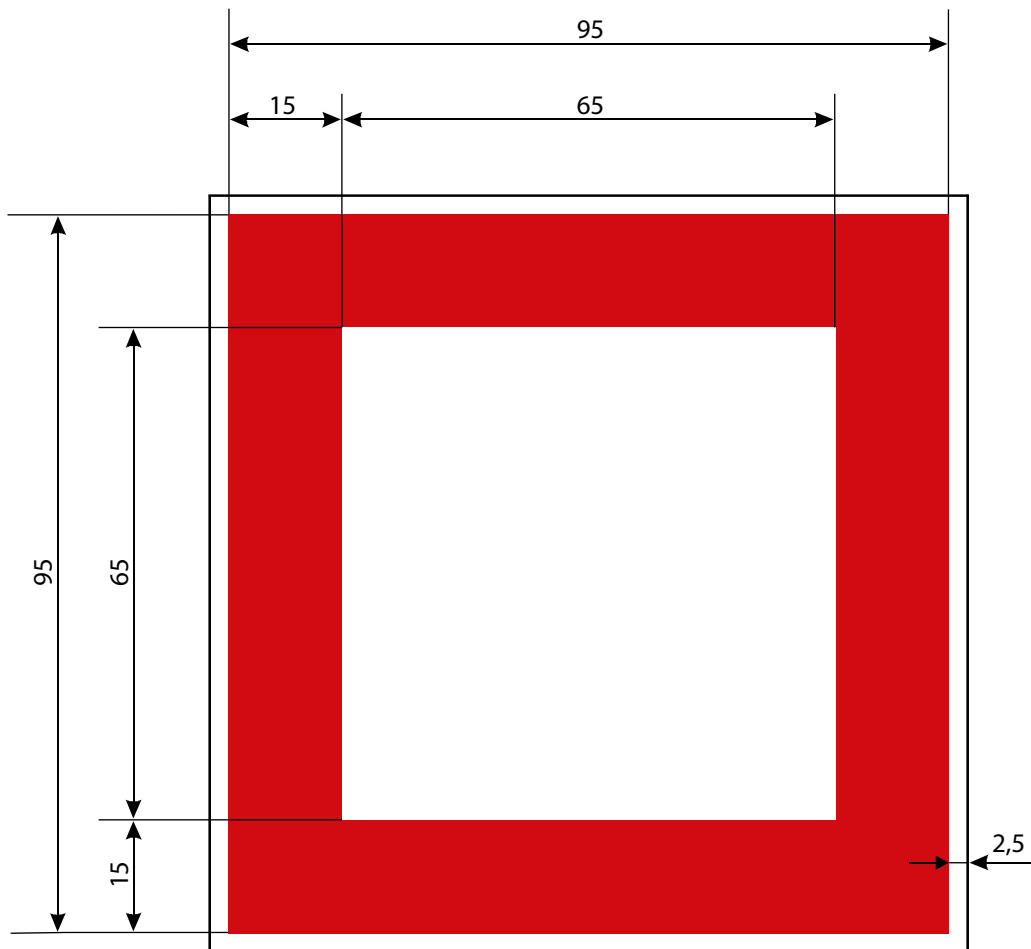
(a) C.3a



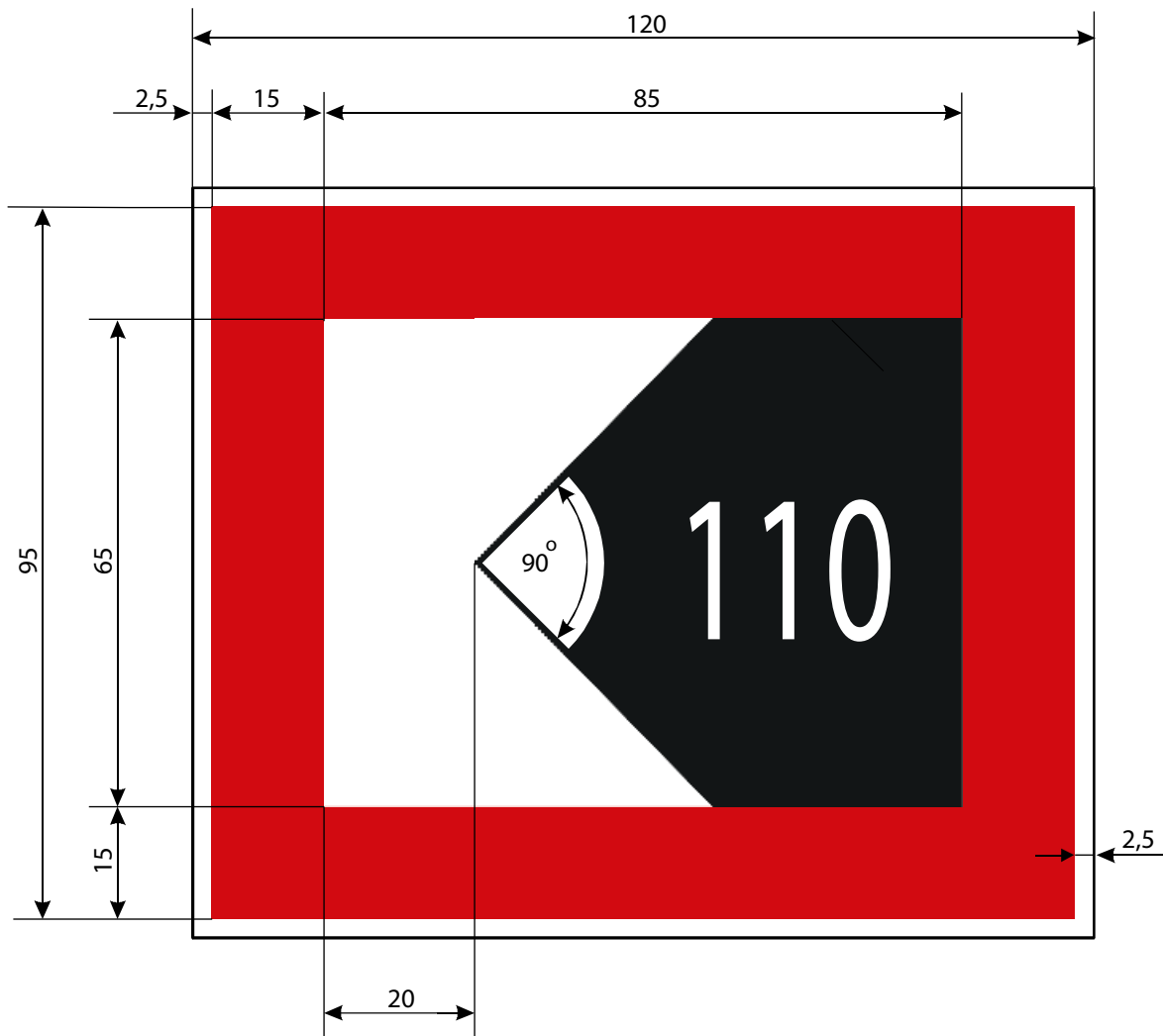
(b) C.3b



C.4 There are restrictions on navigation: see the information plate below the sign



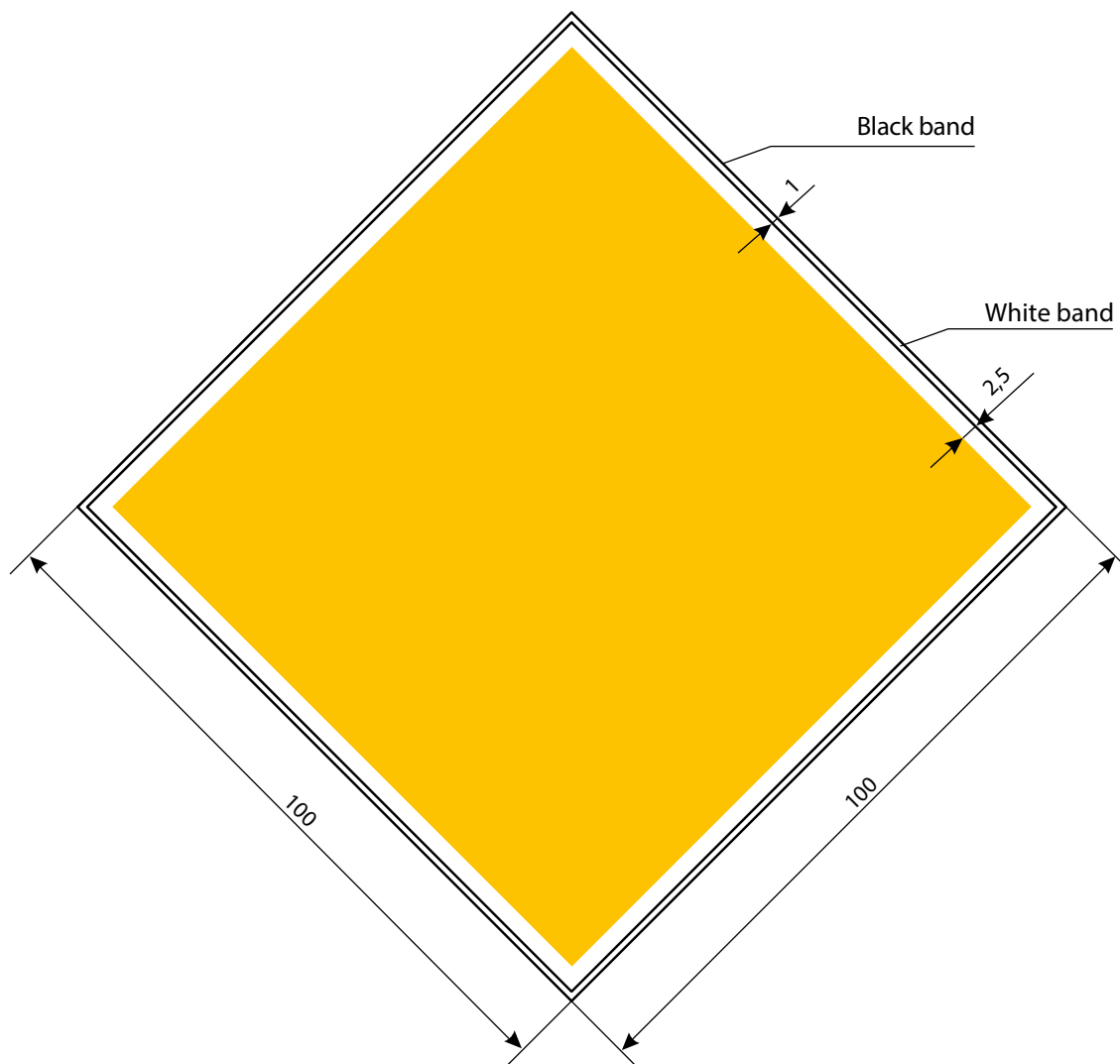
- C.5 The channel lies at a distance from the right (left) bank (the figure shown on the sign indicates the distance in metres, measured from the sign, to which vessels should keep)



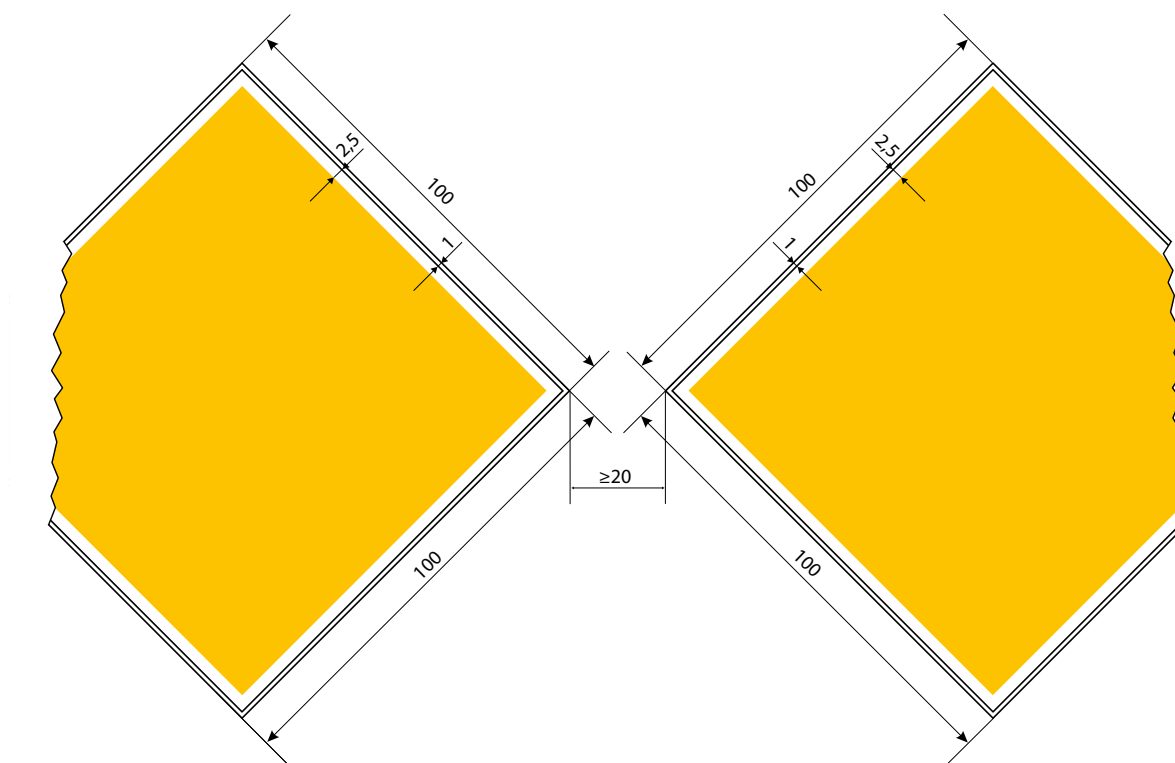
D. *Recommendatory signs*

D.1 Recommended opening

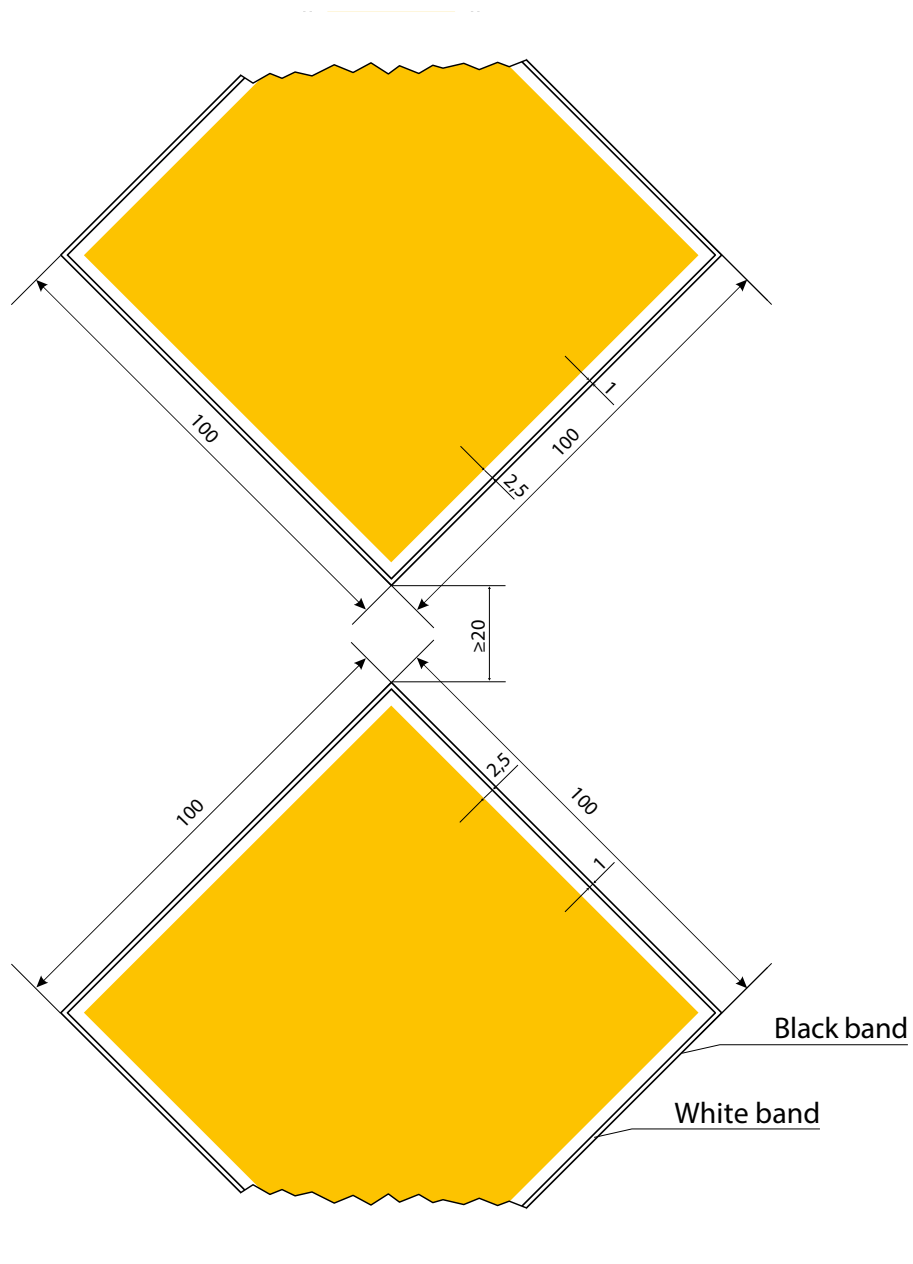
(a) D.1a In both directions



(b) D.1c Only in the direction indicated (passage in the opposite direction prohibited)

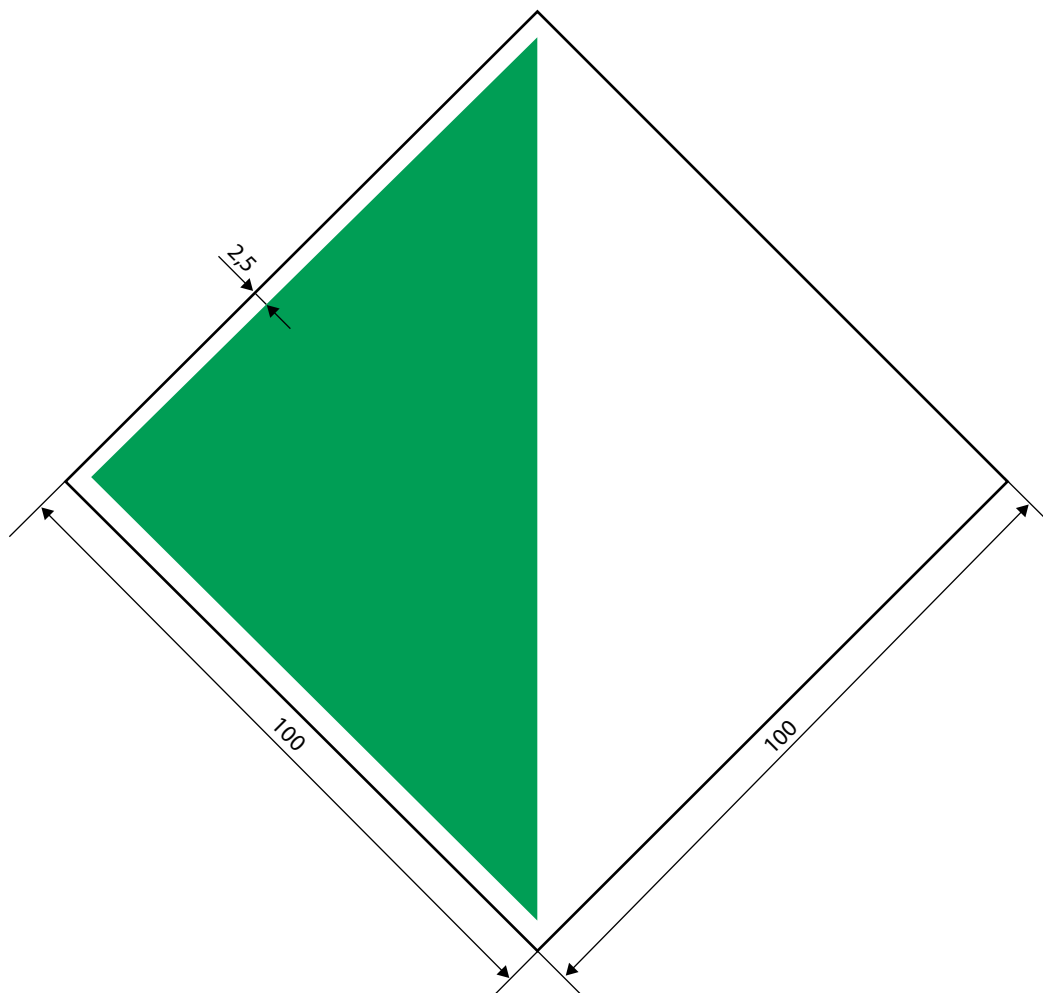


(c) D.1d



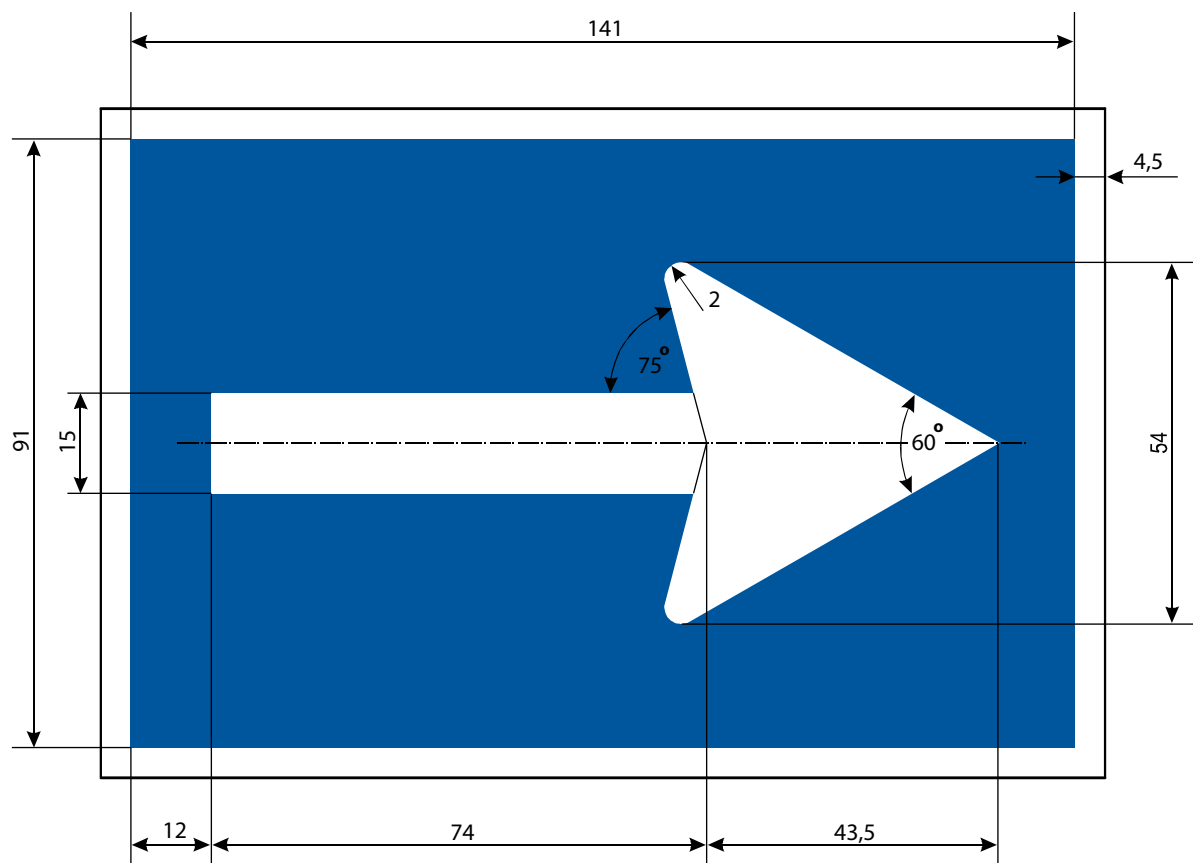
D.2 You are recommended to keep within the area indicated (in openings of bridges or weirs)

D.2a



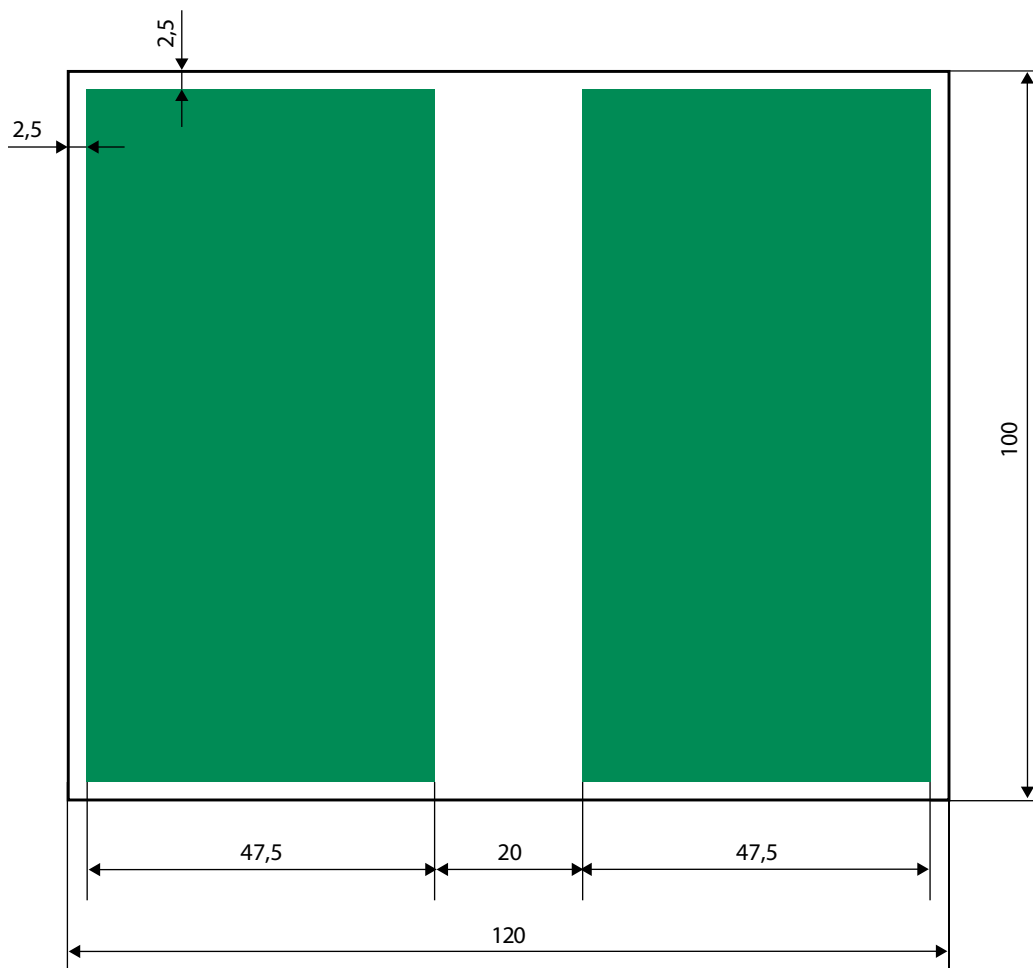
D.3 You are recommended to proceed:

D.3a In the direction shown by the arrow

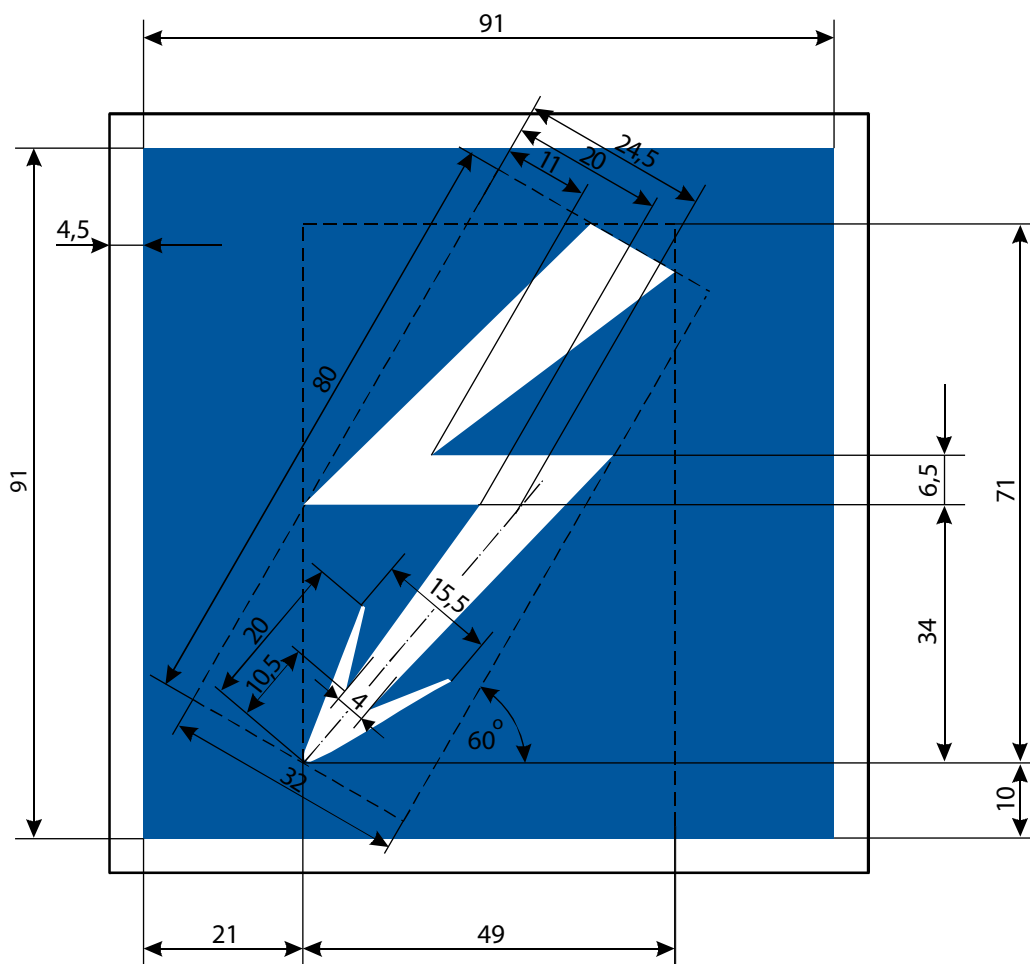


E. Informative signs

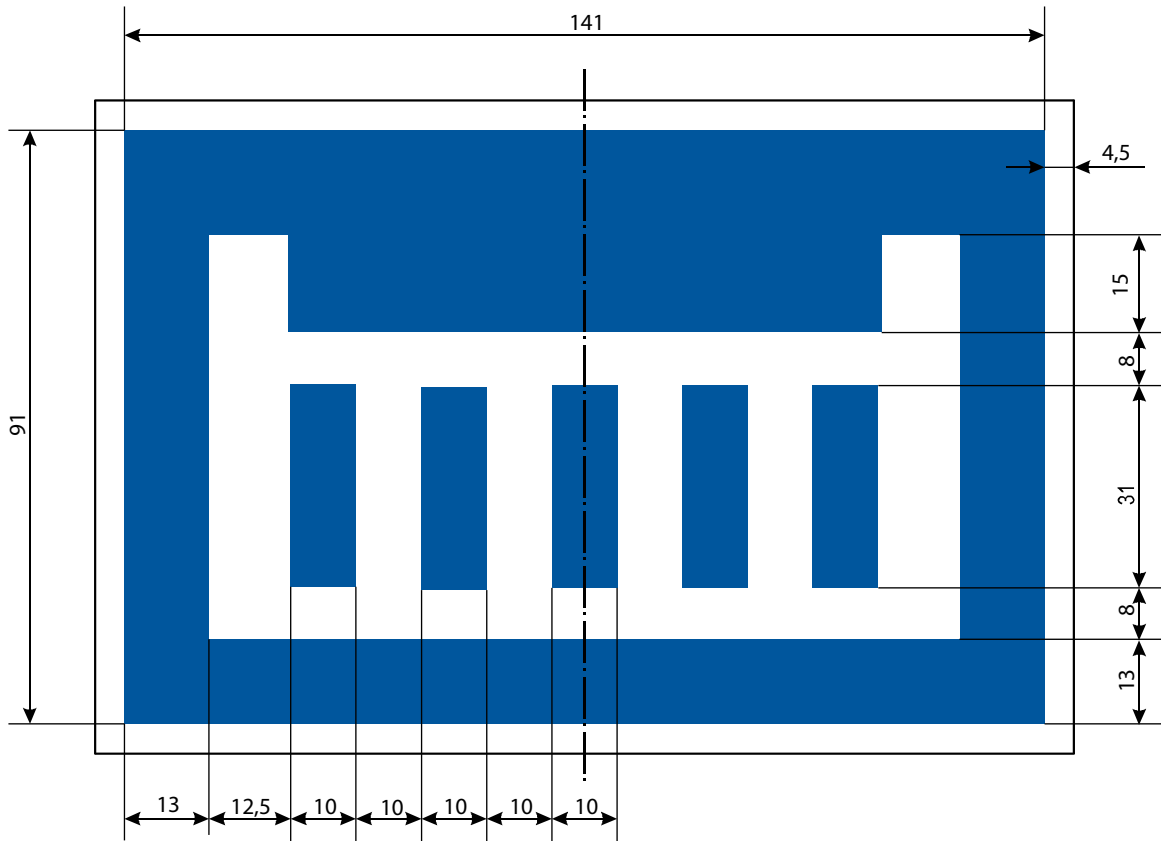
E.1a Entry permitted



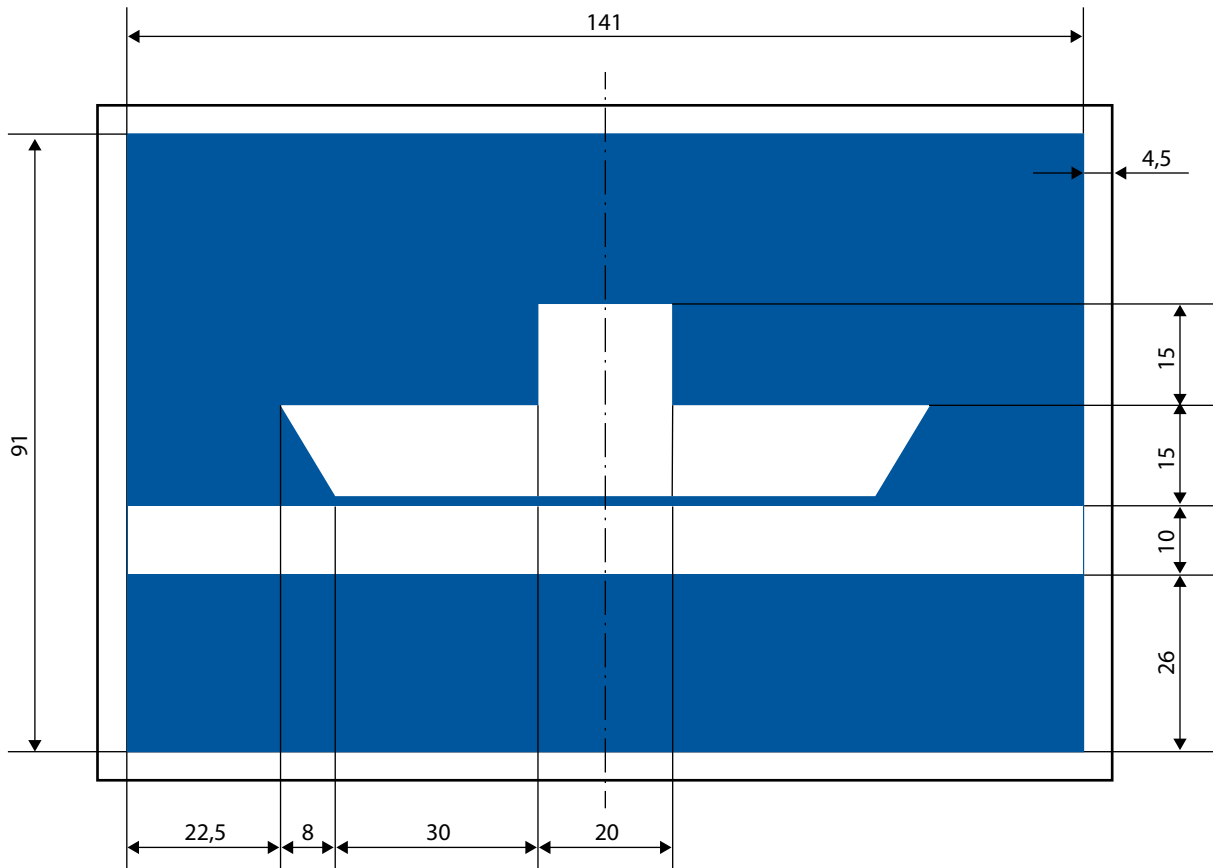
E.2 Overhead cable crossing



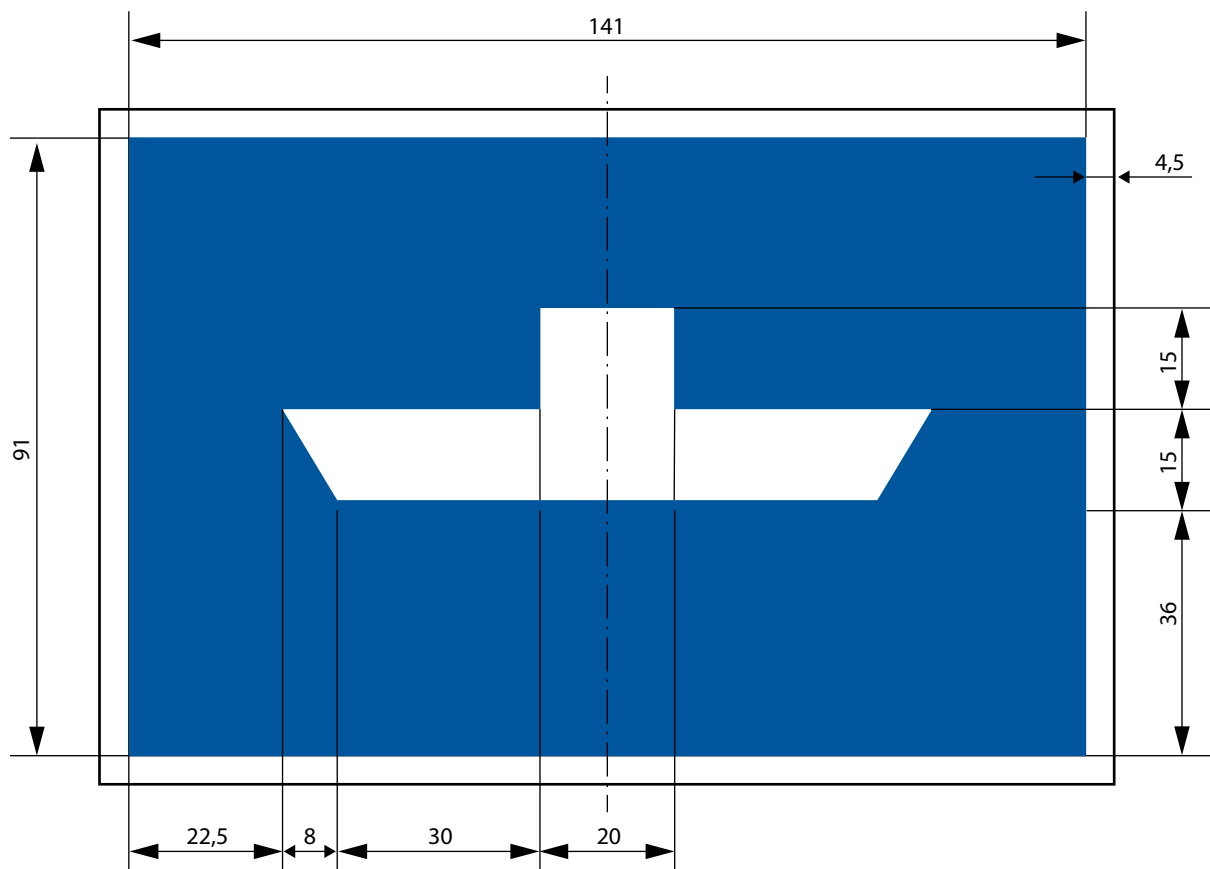
E3 Weir



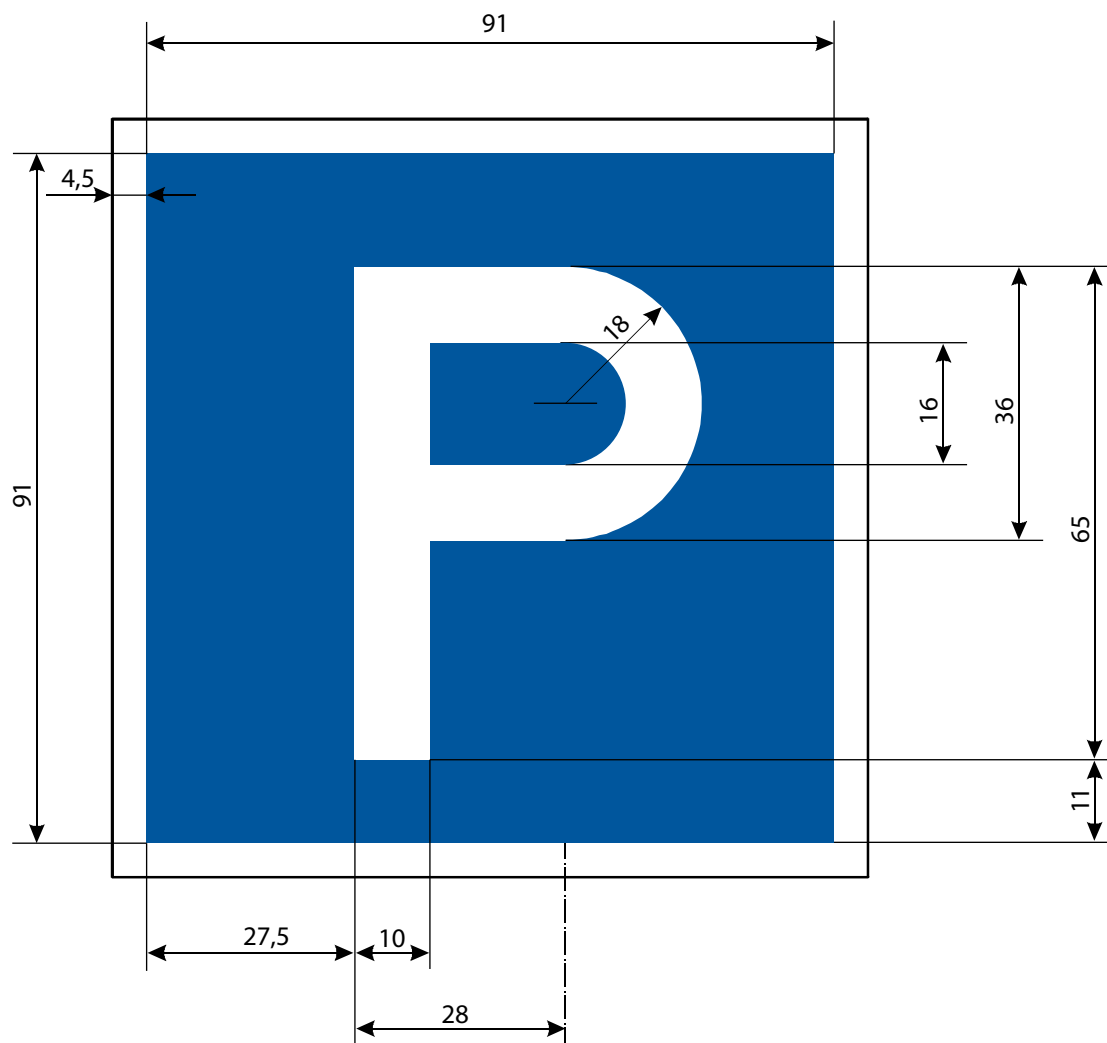
E.4a Ferry-boat not moving independently



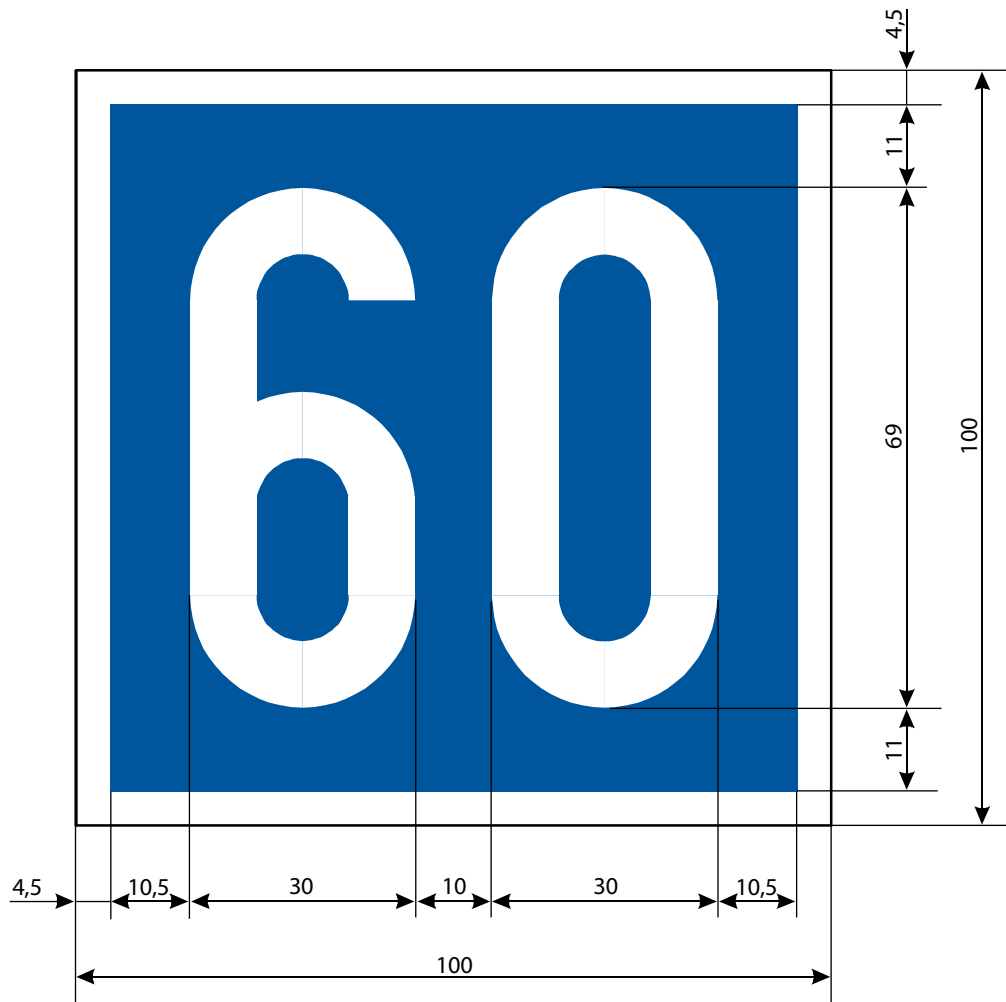
E.4b Ferry-boat moving independently



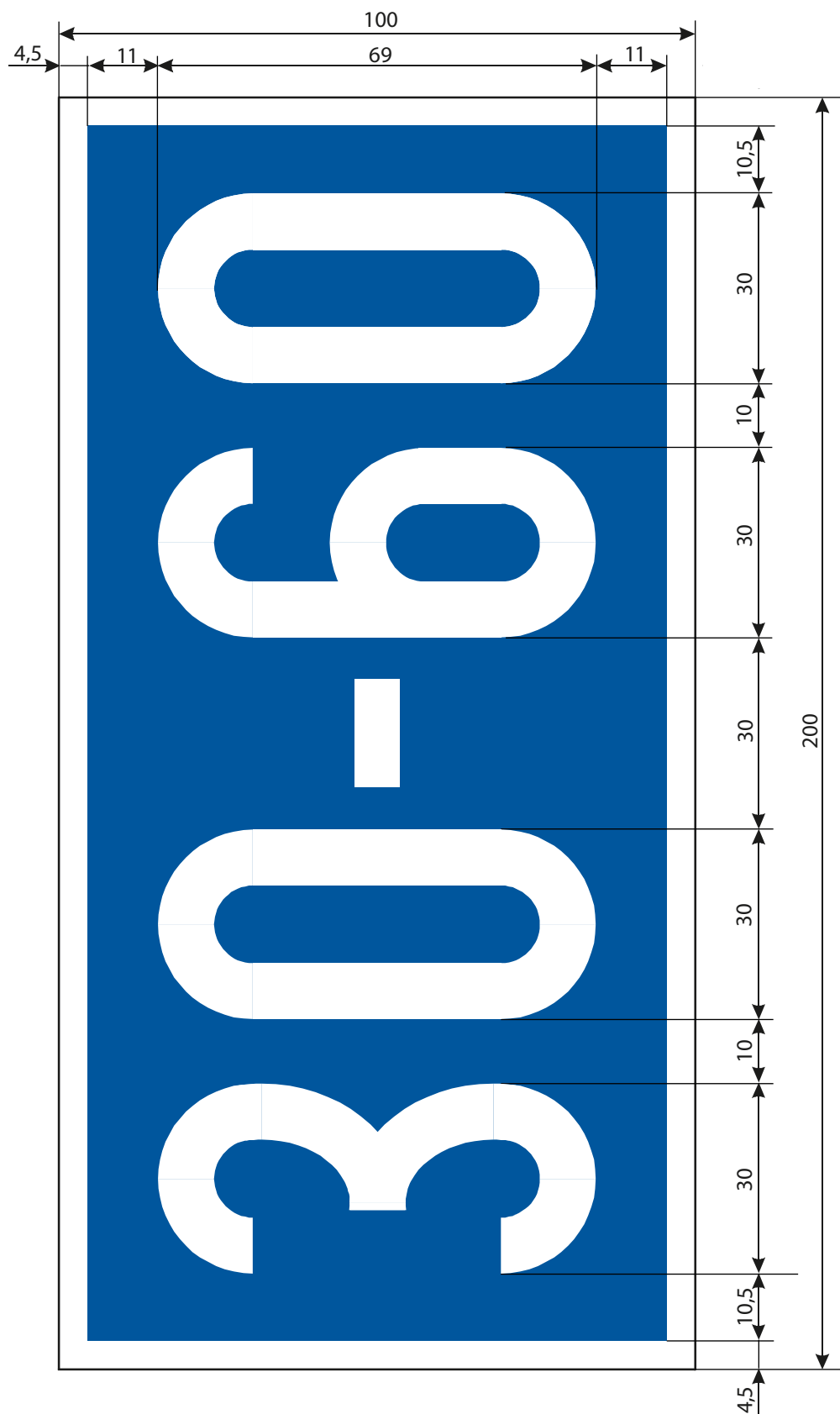
- E.5 Berthing (i.e. anchoring or making fast to the bank) permitted on the side of the waterway on which the sign is placed



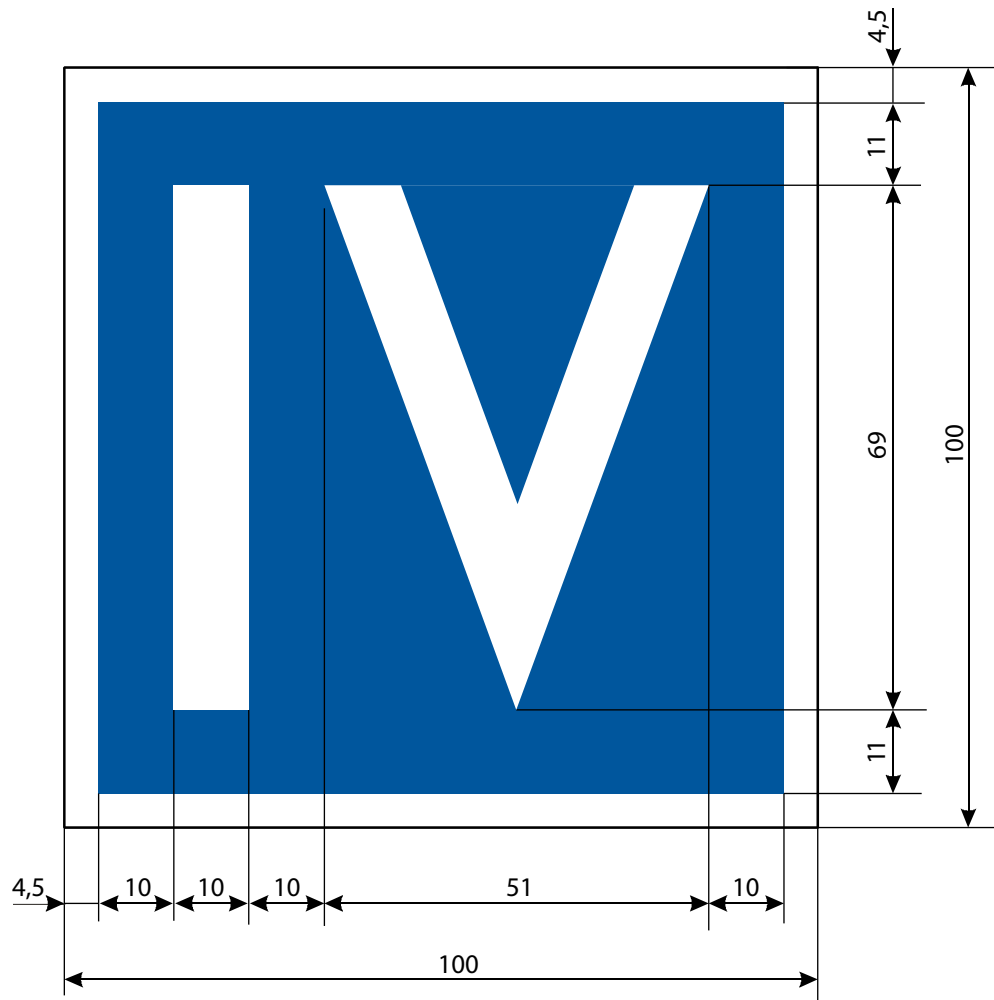
- E.5.1 Berthing permitted on the stretch of water of the breadth measured from, and shown on the board in metres



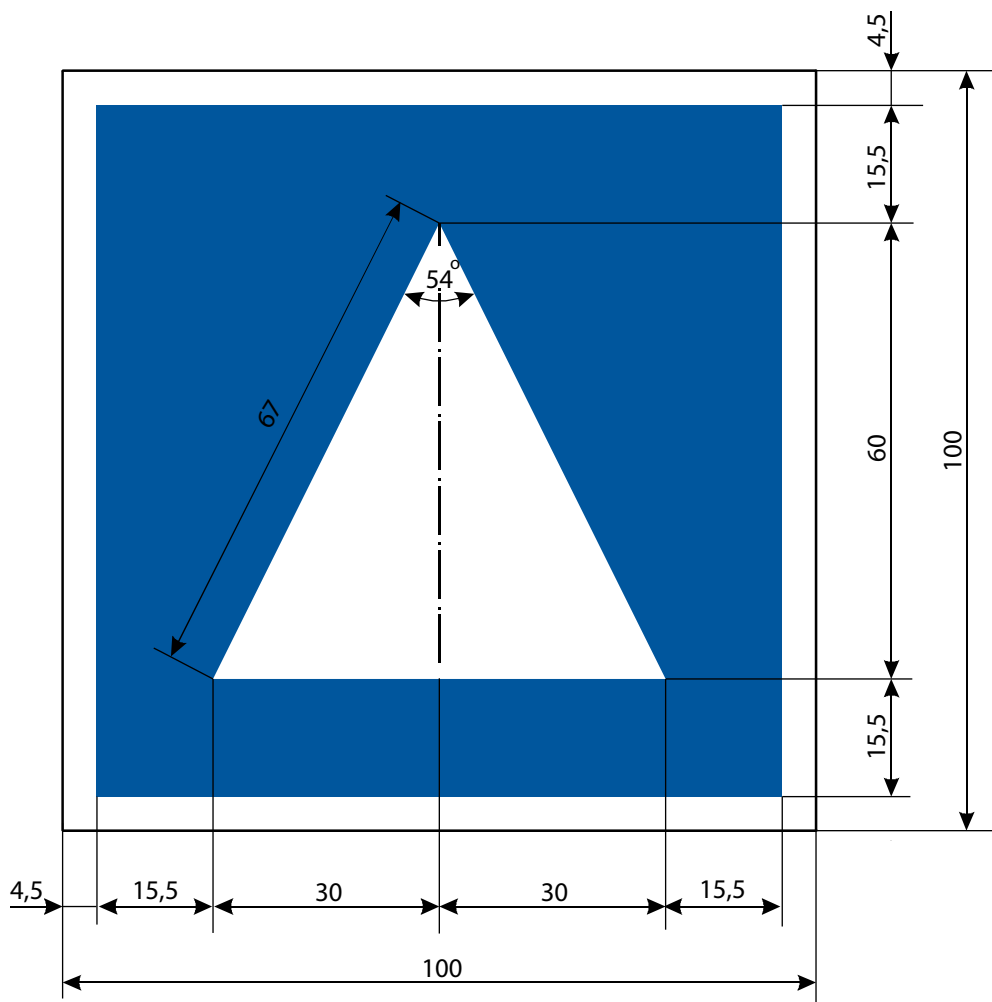
E.5.2 Berthing permitted on the stretch of water bounded by the two distances measured from, and shown on the board in metres



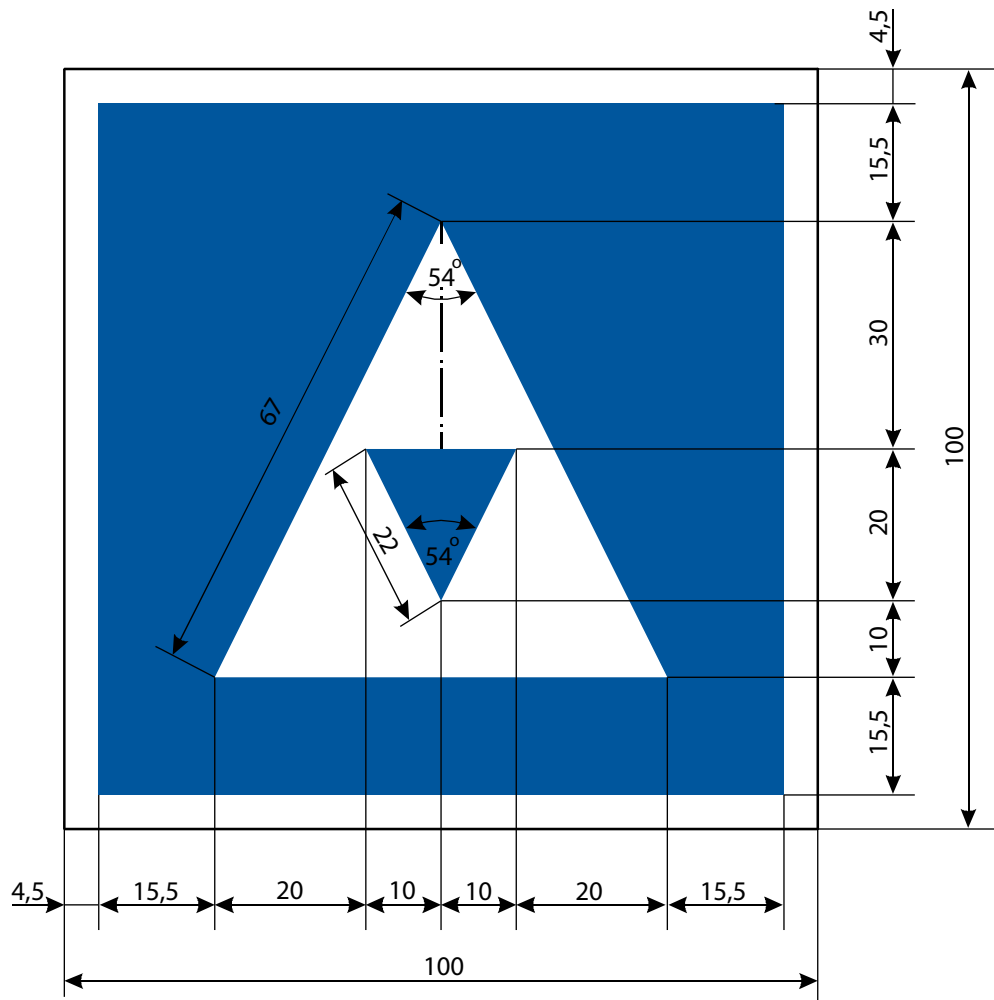
E.5.3 Maximum number of vessels permitted to berth abreast on the side of the waterway on which the sign is placed



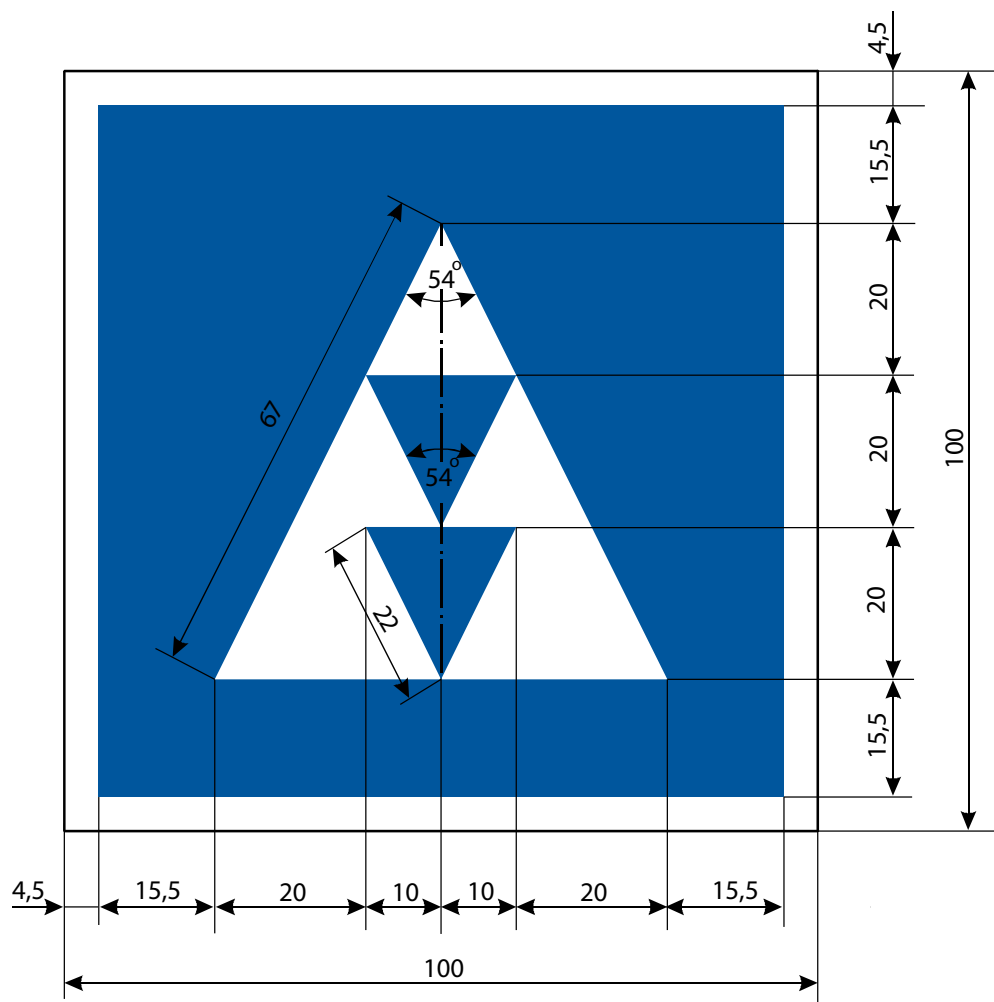
- E.5.4 Berthing area reserved for pushing-navigation vessels that are not required to carry the marking prescribed in article 3.14 of CEVNI on the side of the waterway on which the sign is placed



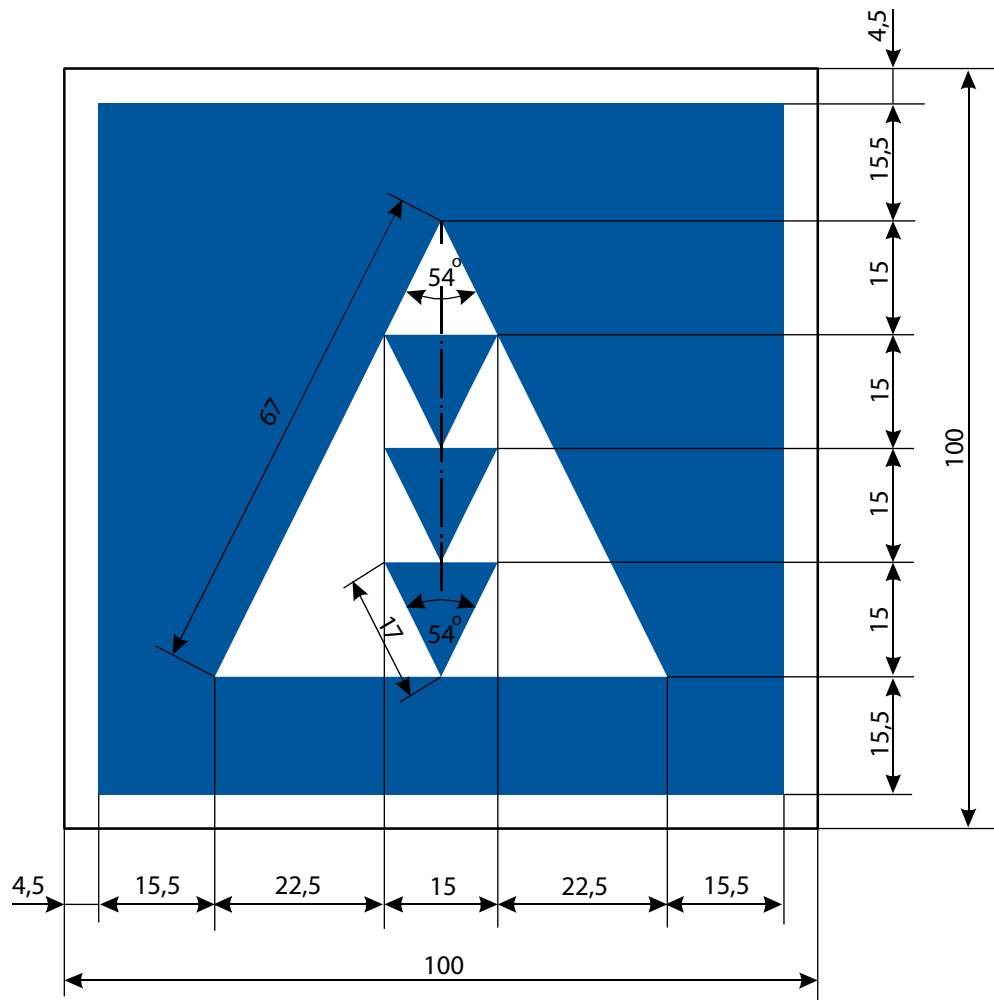
- E.5.5 Berthing area reserved for pushing-navigation vessels that are required to carry one blue light or one blue cone under article 3.14, para. 1 of CEVNI on the side of the waterway on which the sign is placed



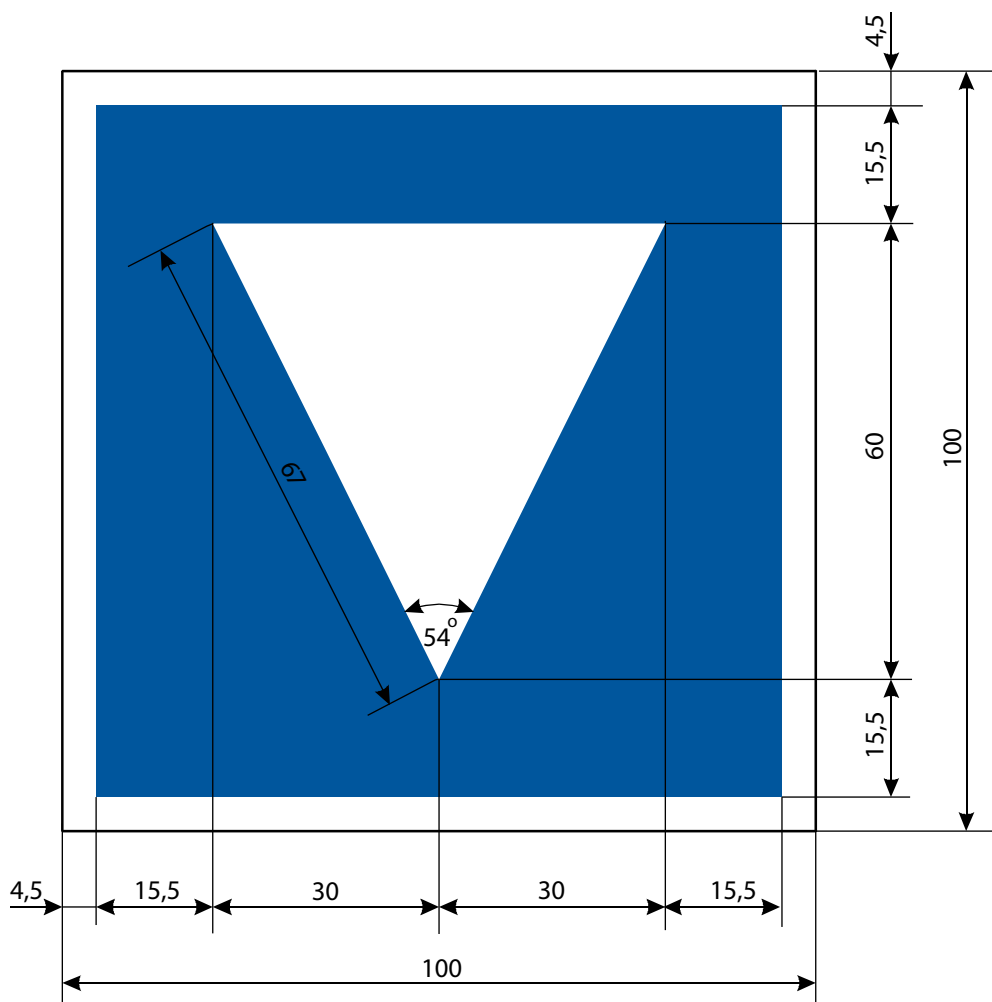
- E.5.6 Berthing area reserved for pushing-navigation vessels that are required to carry two blue lights or two blue cones under article 3.14, para. 2 of CEVNI on the side of the waterway on which the sign is placed



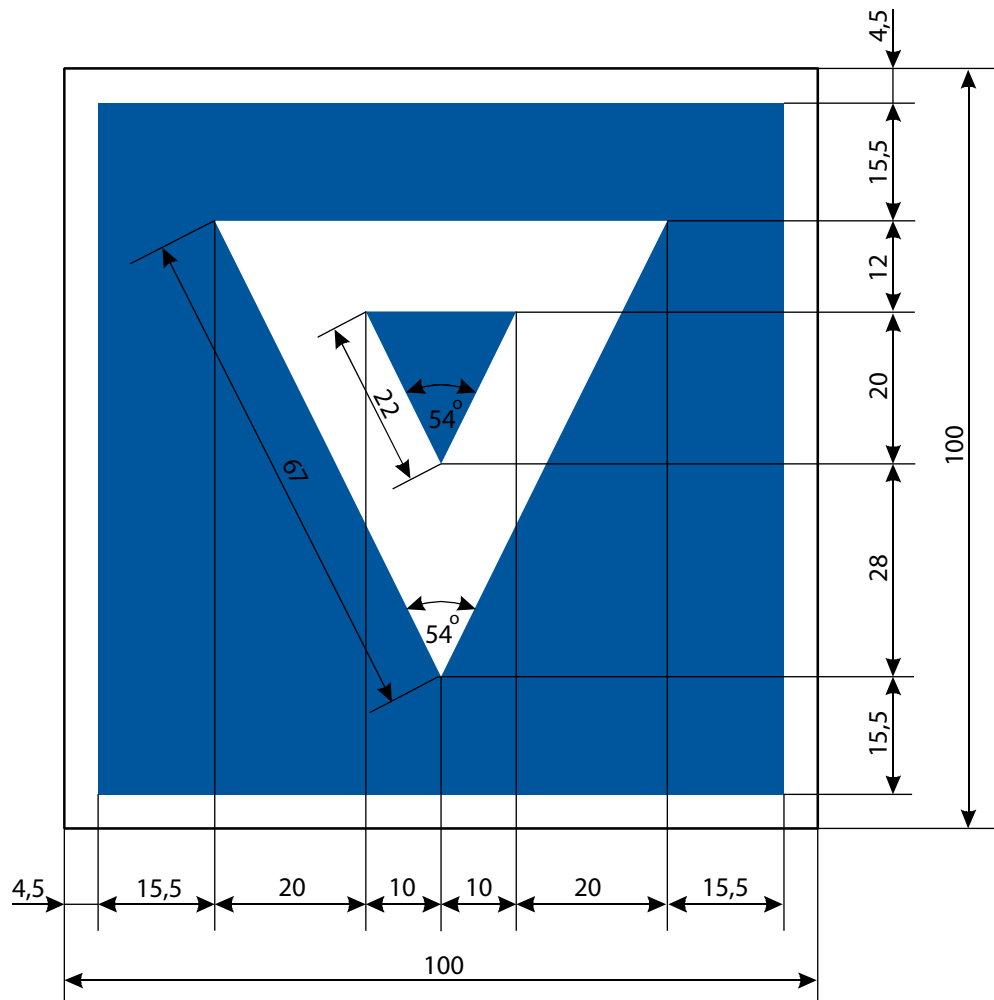
- E.5.7 Berthing area reserved for pushing-navigation vessels that are required to carry three blue lights or three blue cones under article 3.14, para. 3 of CEVNI on the side of the waterway on which the sign is placed



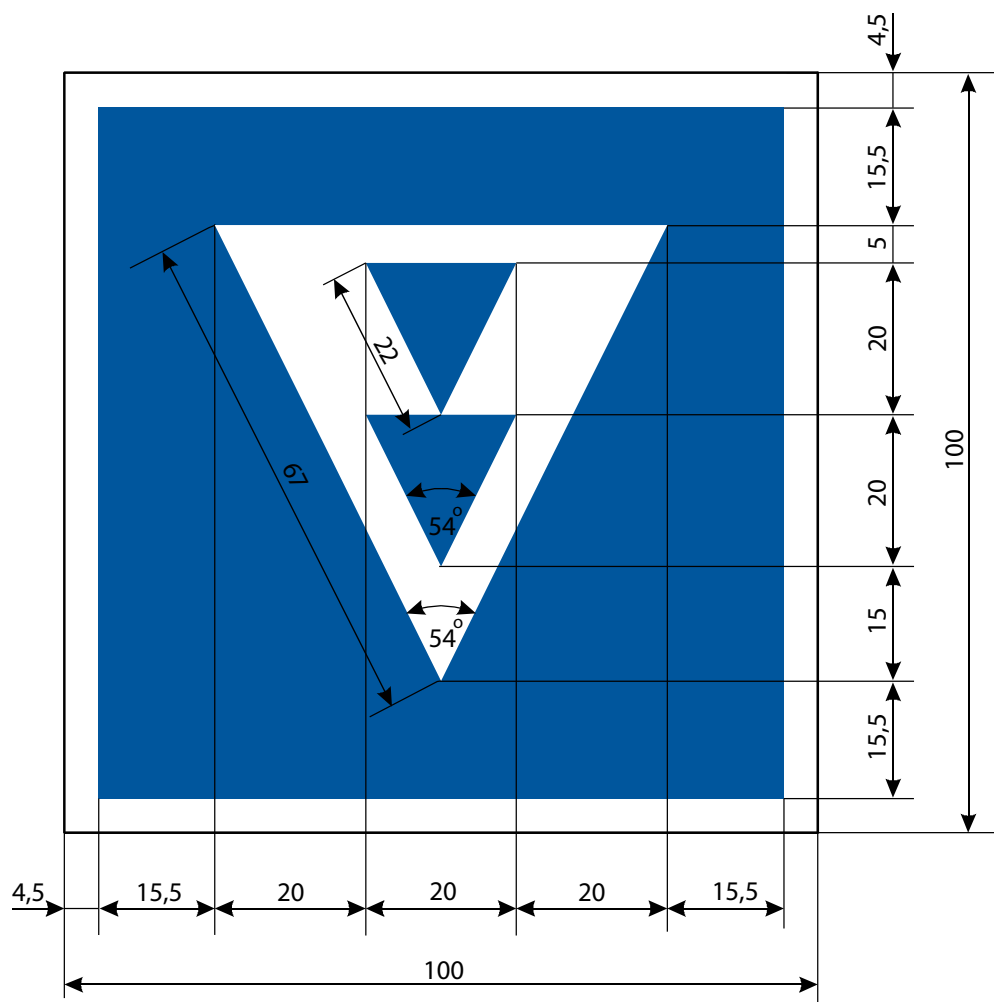
- E.5.8 Berthing area reserved for vessels other than pushing-navigation vessels that are not required to carry the marking prescribed in article 3.14 of CEVNI on the side of the waterway on which the sign is placed



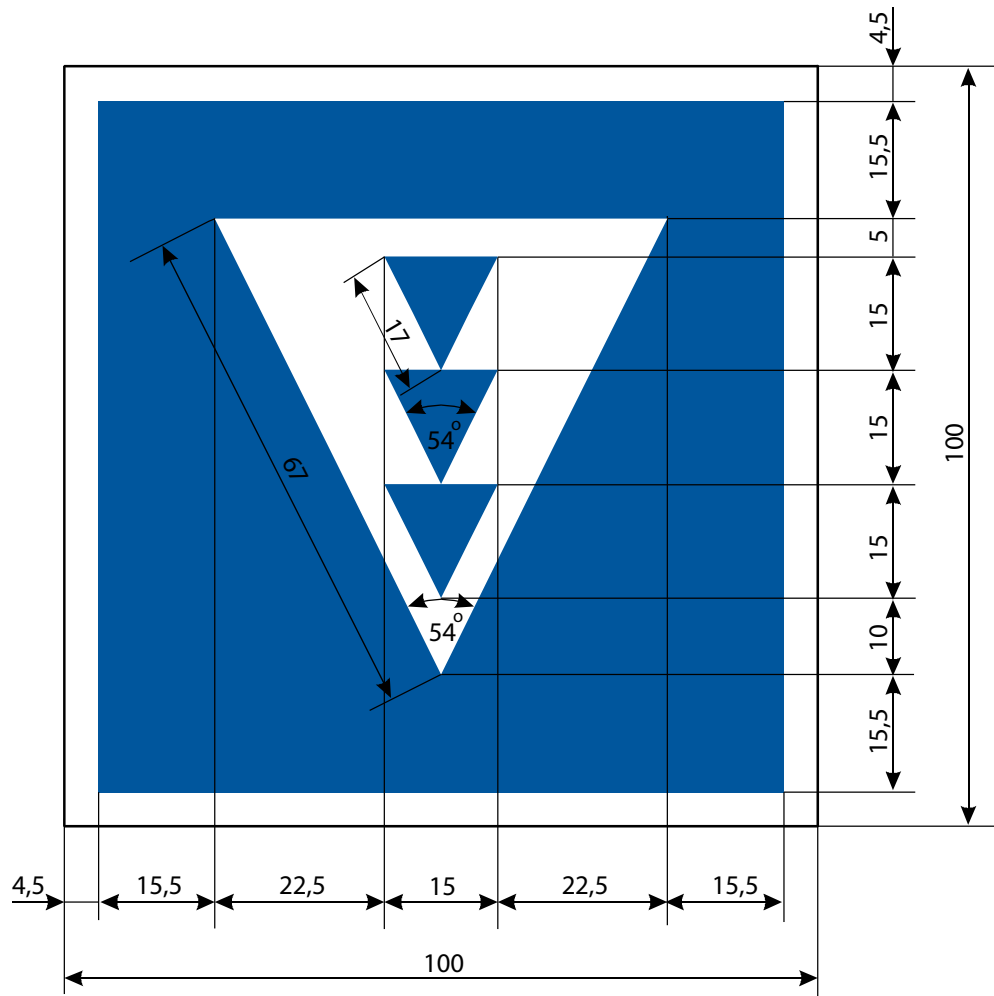
- E.5.9 Berthing area reserved for vessels other than pushing-navigation vessels that are required to carry one blue light or one blue cone under article 3.14, para. 1 of CEVNI on the side of the waterway on which the sign is placed



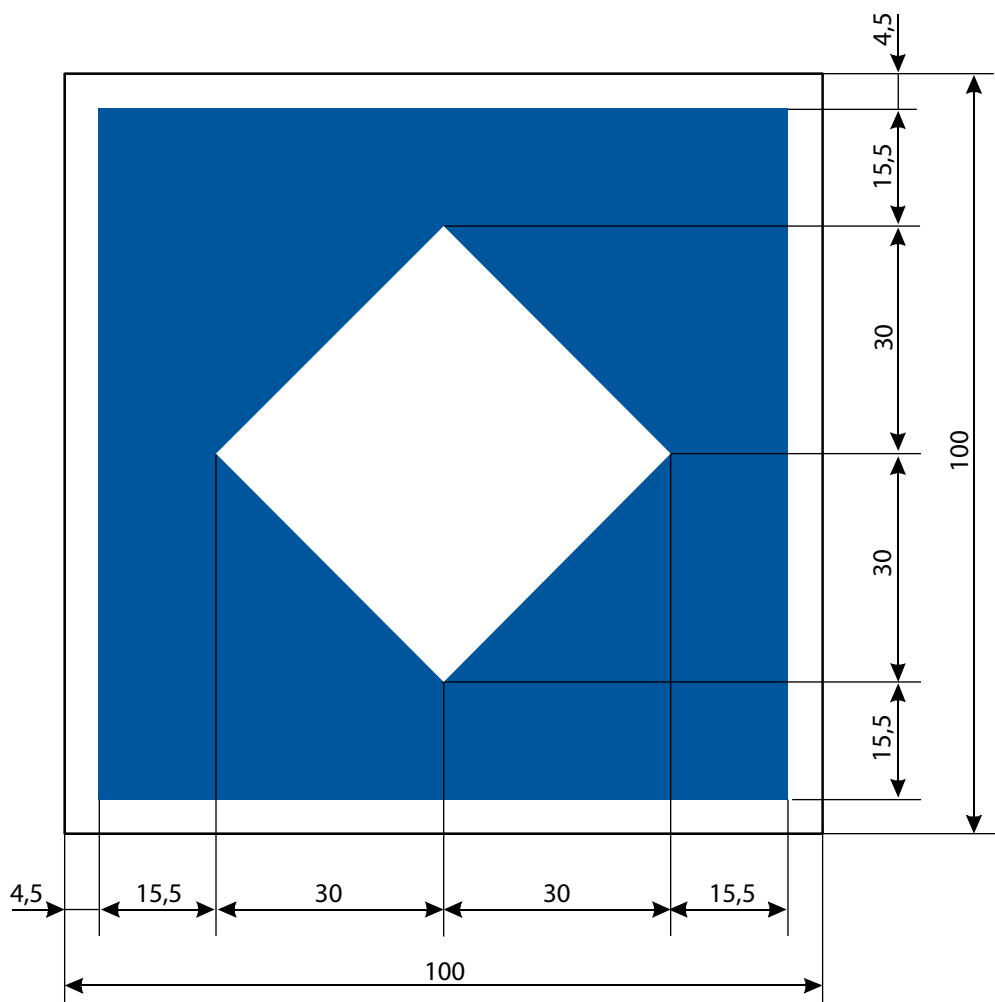
- E.5.10 Berthing area reserved for vessels other than pushing-navigation vessels that are required to carry two blue lights or two blue cones under article 3.14, para. 2 of CEVNI on the side of the waterway on which the sign is placed



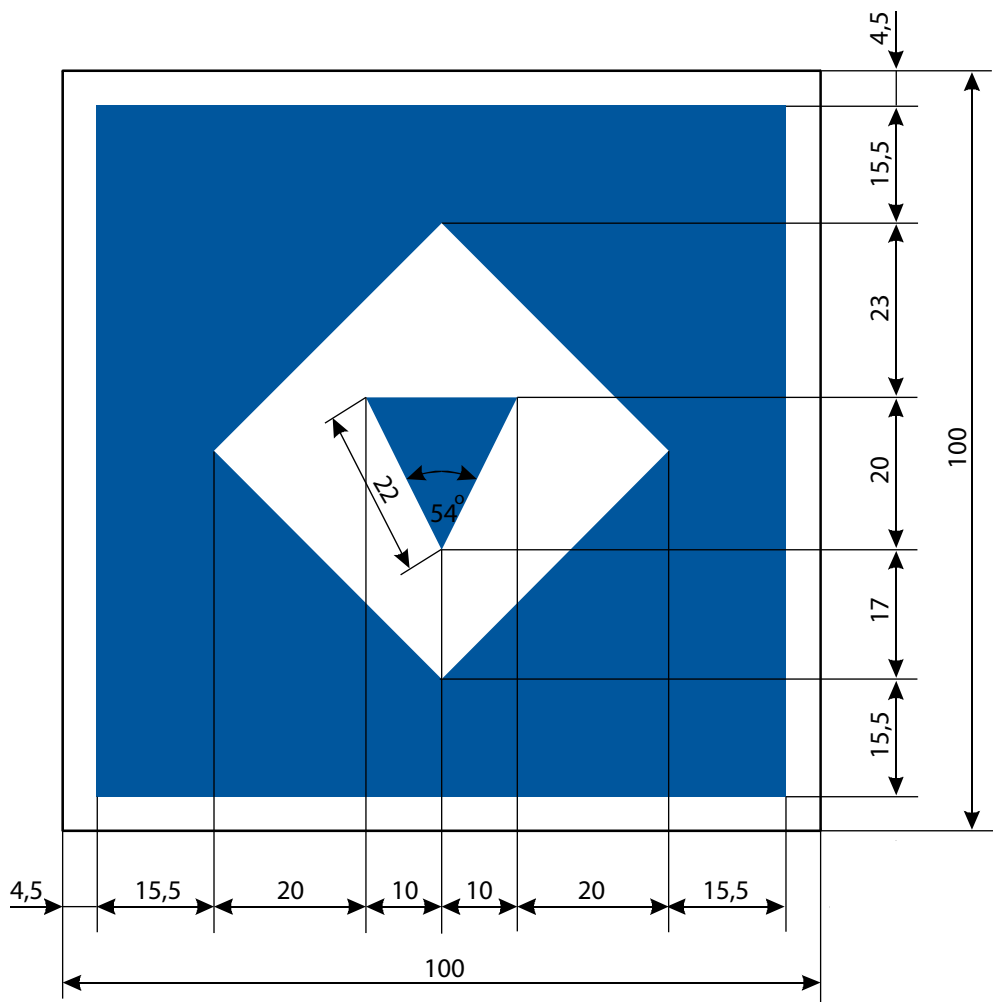
- E.5.11 Berthing area reserved for vessels other than pushing-navigation vessels that are required to carry three blue lights or three blue cones under article 3.14, para. 3 of CEVNI on the side of the waterway on which the sign is placed



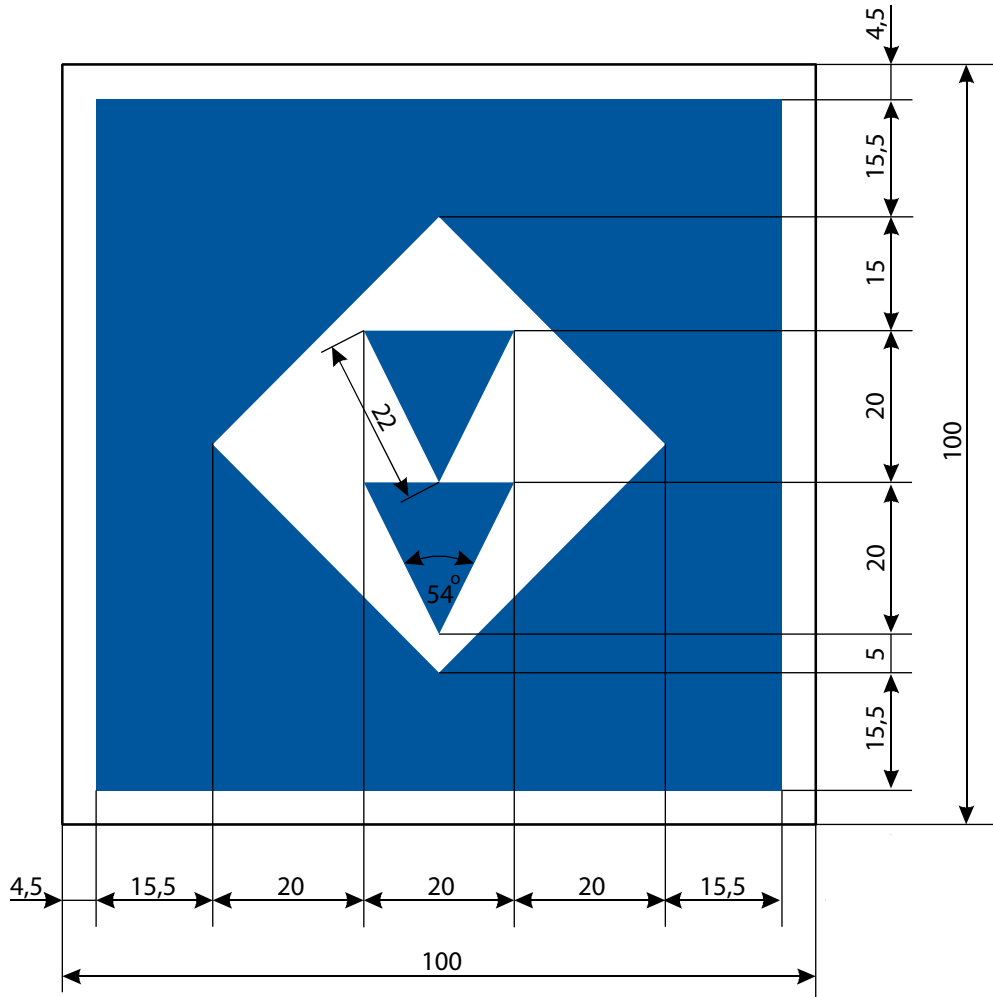
E.5.12 Berthing area reserved for all vessels that are not required to carry the marking prescribed in article 3.14 of CEVNI, on the side of the waterway on which the sign is placed



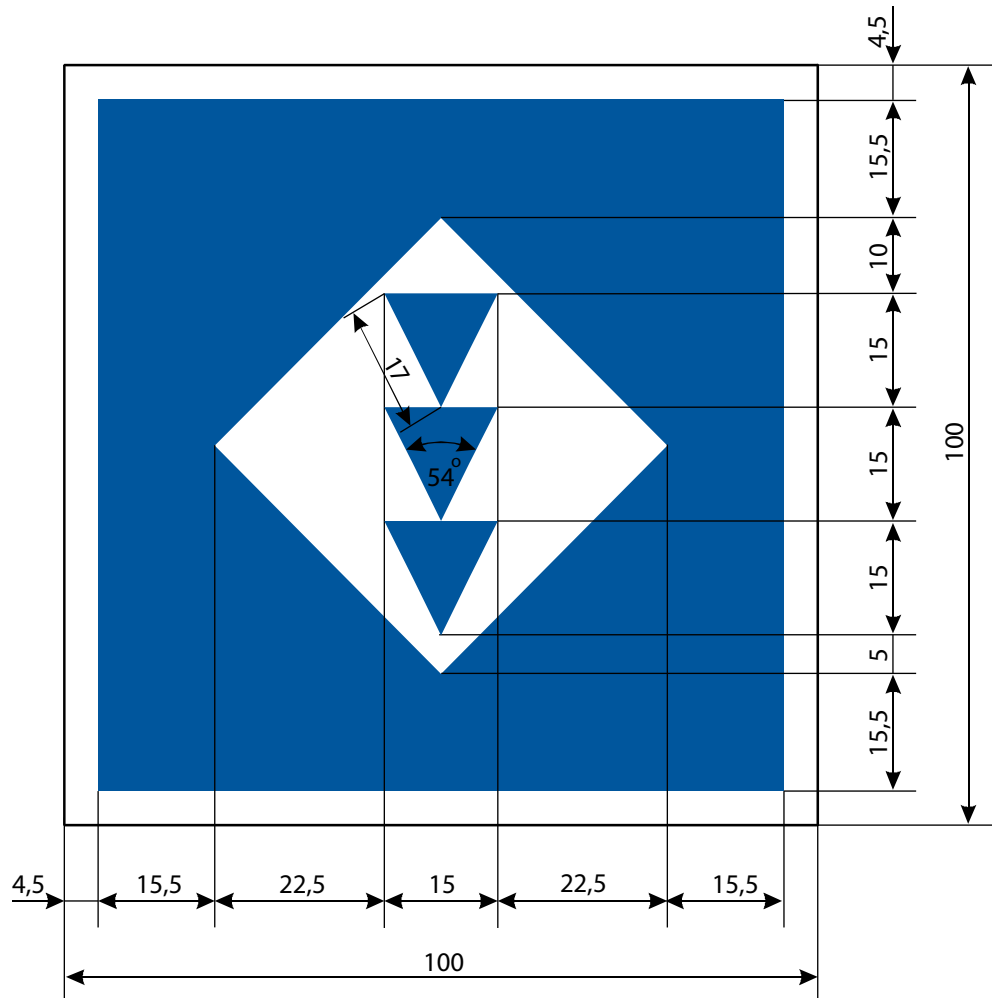
E.5.13 Berthing area reserved for all vessels that are required to carry one blue light or one blue cone under article 3.14, para. 1 of CEVNI, on the side of the waterway on which the sign is placed



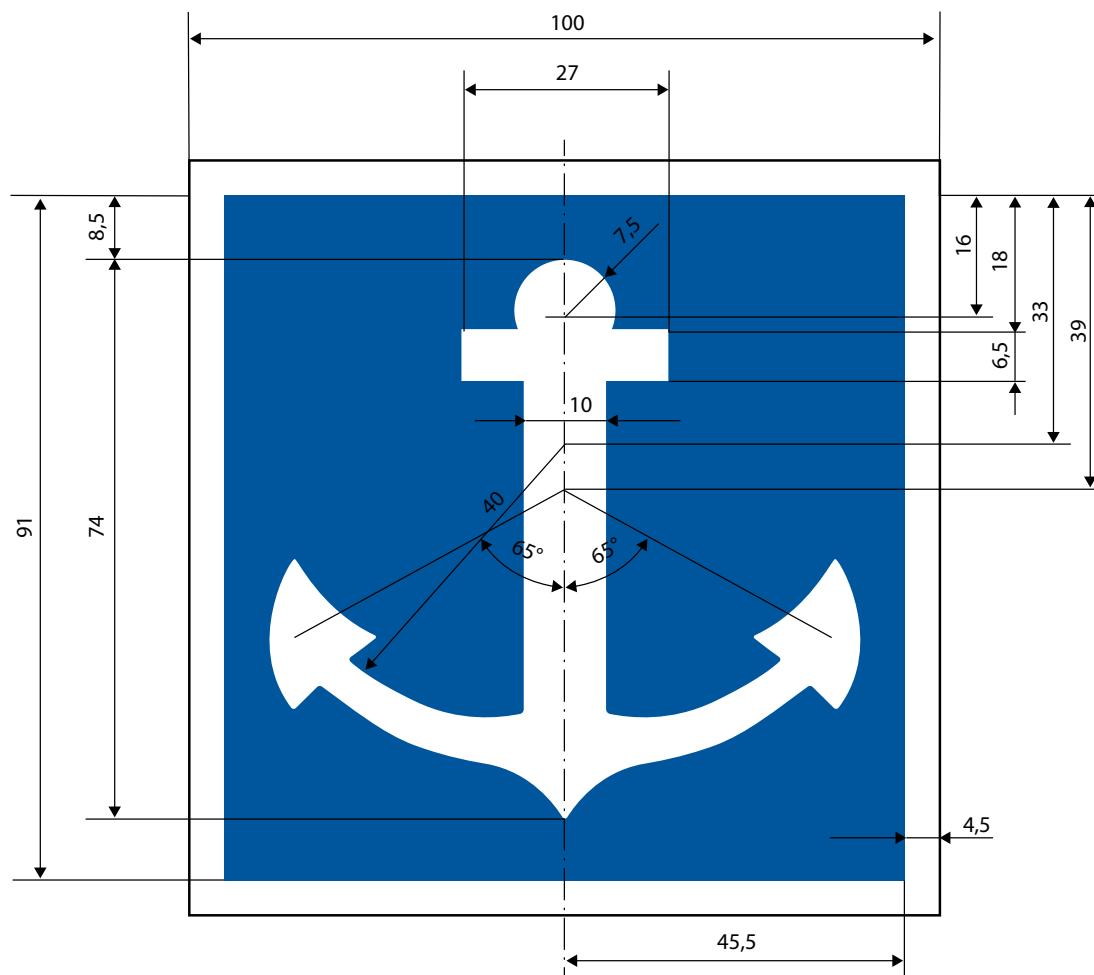
E.5.14 Berthing area reserved for all vessels that are required to carry two blue lights or two blue cones under article 3.14, para. 2 of CEVNI



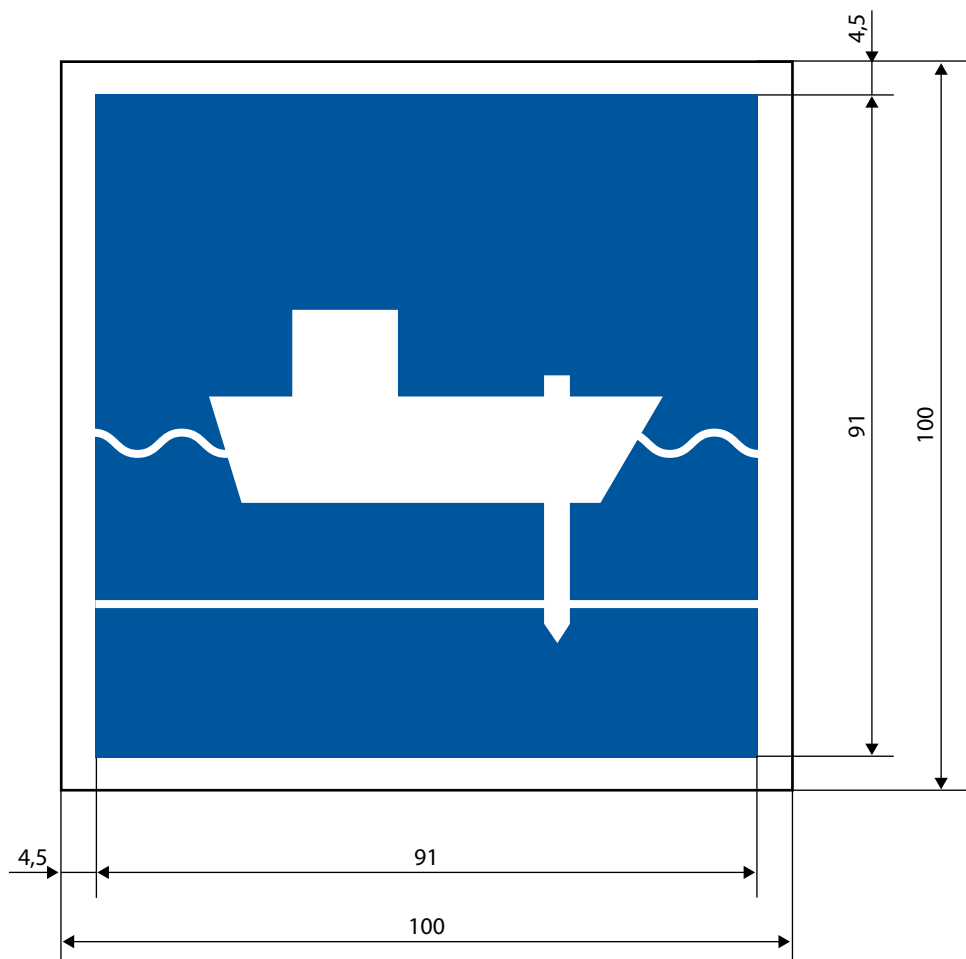
E.5.15 Berthing area reserved for all vessels that are required to carry three blue lights or three blue cones under article 3.14, para. 3 of CEVNI, on the side of the waterway on which the sign is placed



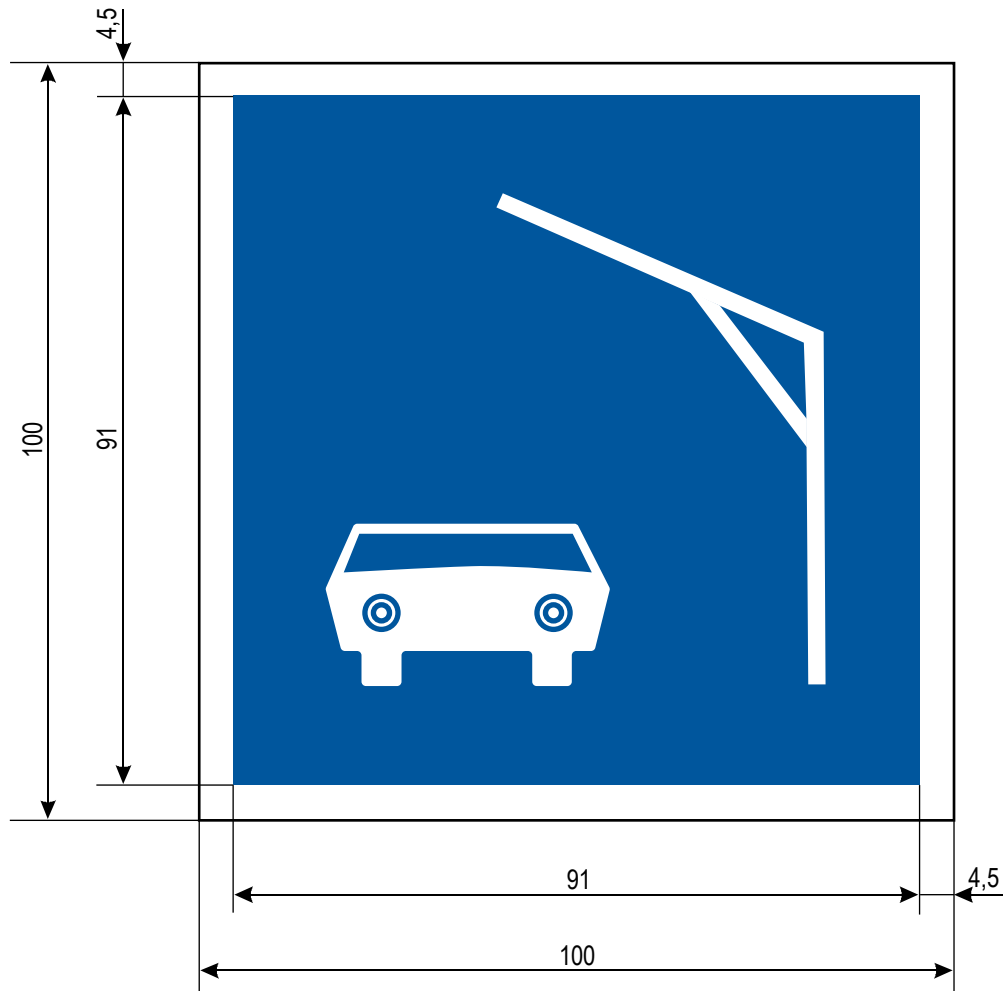
- E.6 Anchoring or trailing of anchors, cables or chains permitted on the side of the waterway on which the sign is placed



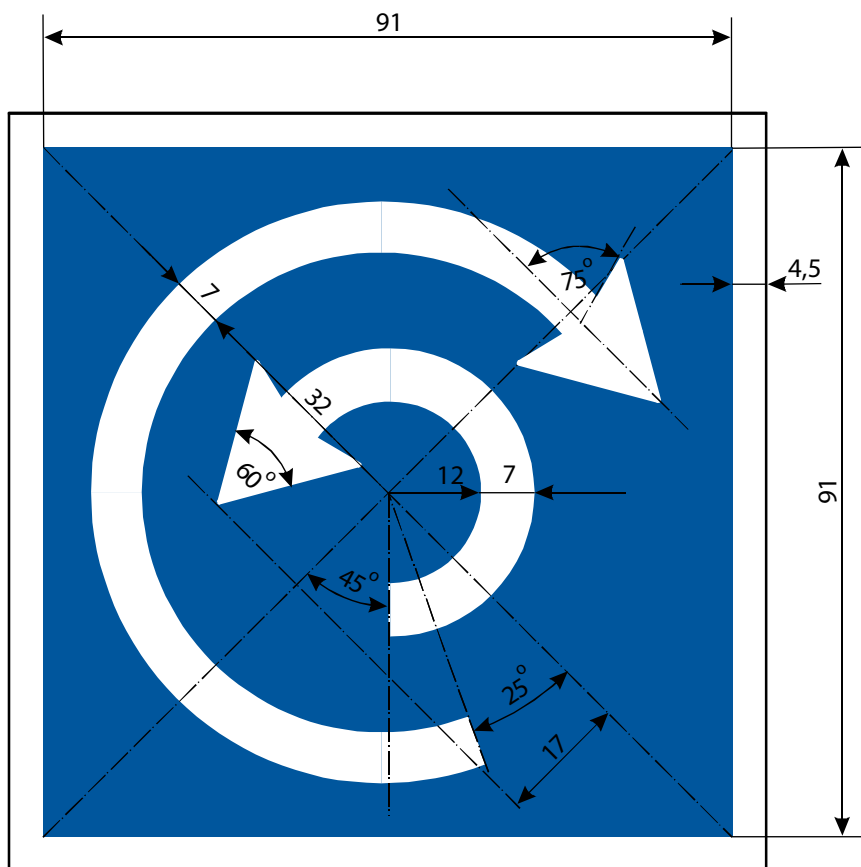
E.6.1 Use of spuds permitted



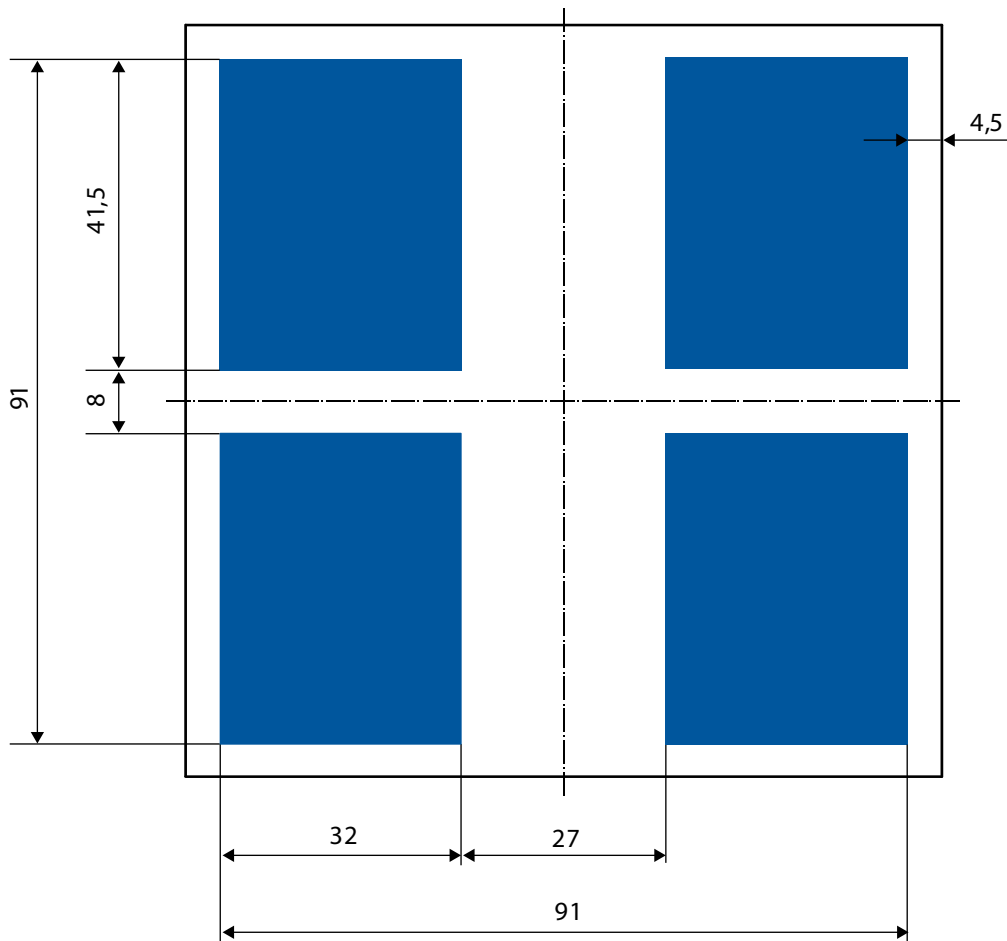
E.7.1 Berthing area reserved for loading and unloading vehicles (maximum duration of berthing permitted may be added on an information plate below the board)



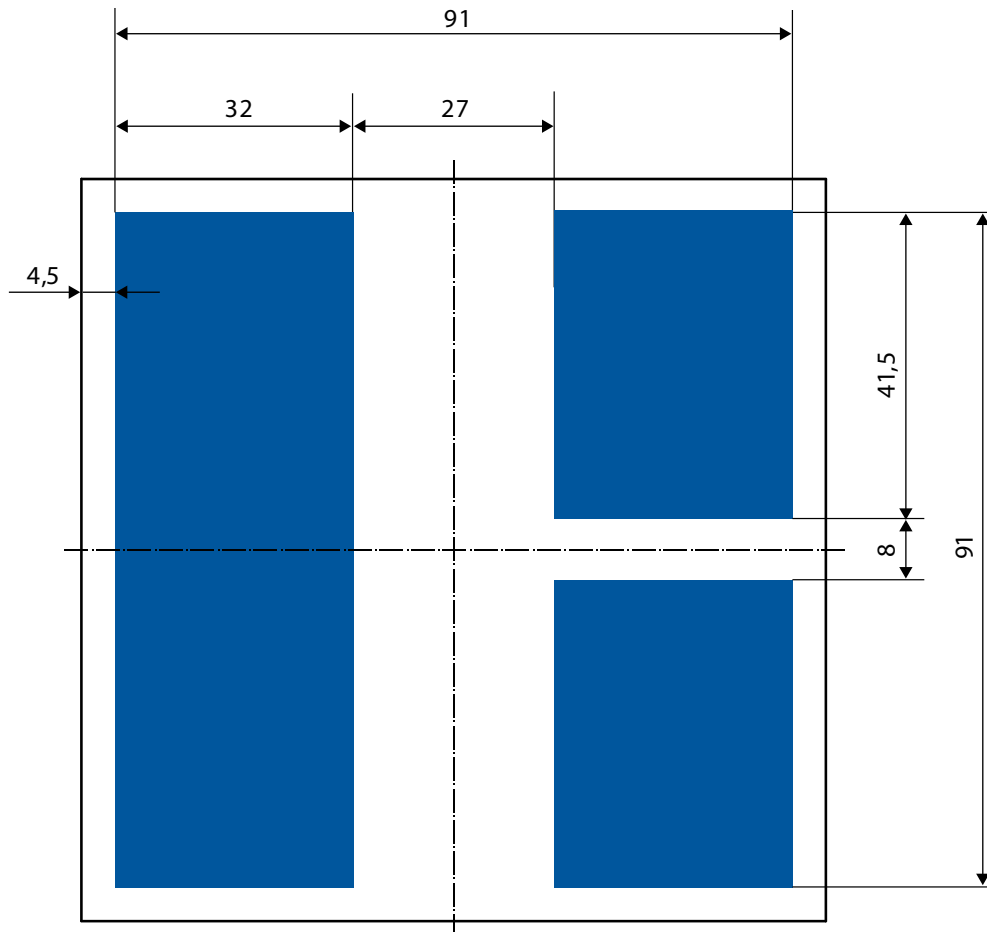
E.8 Turning area



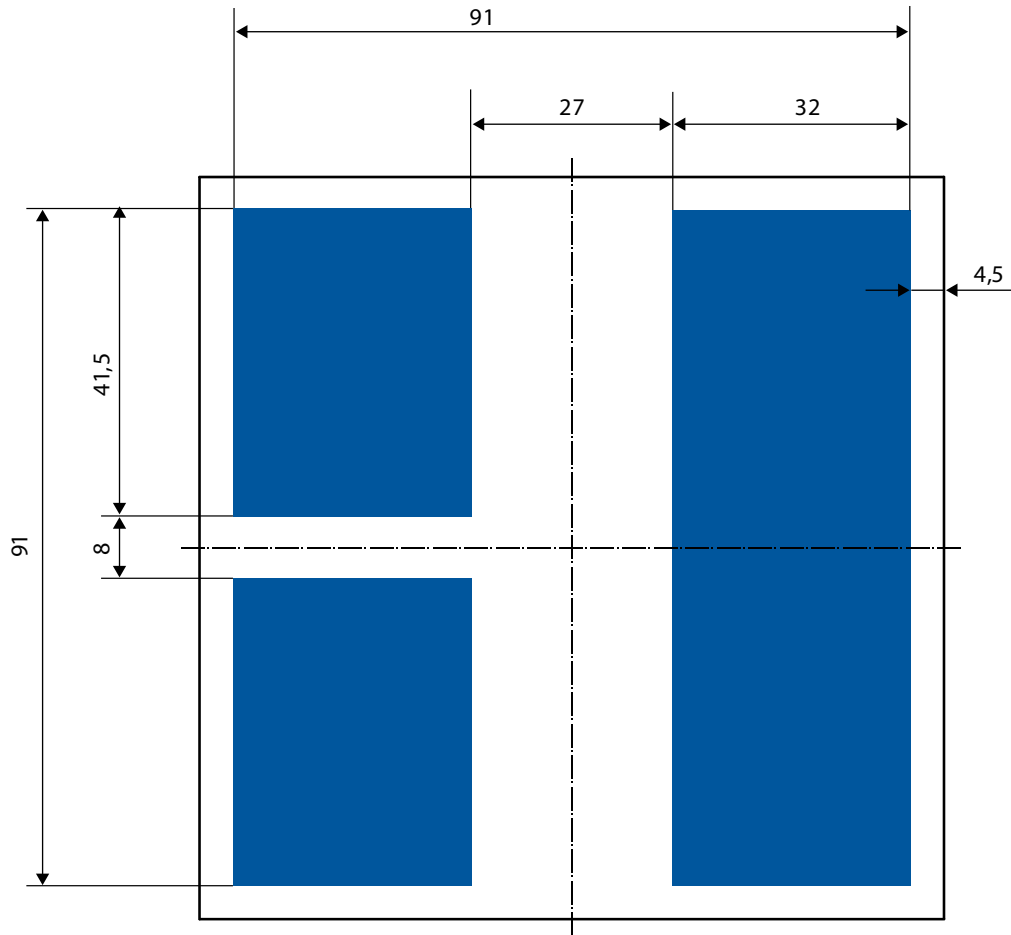
- E.9 The waterways being approached are considered to be tributaries of this waterway
(a) E.9a



(b) E.9b

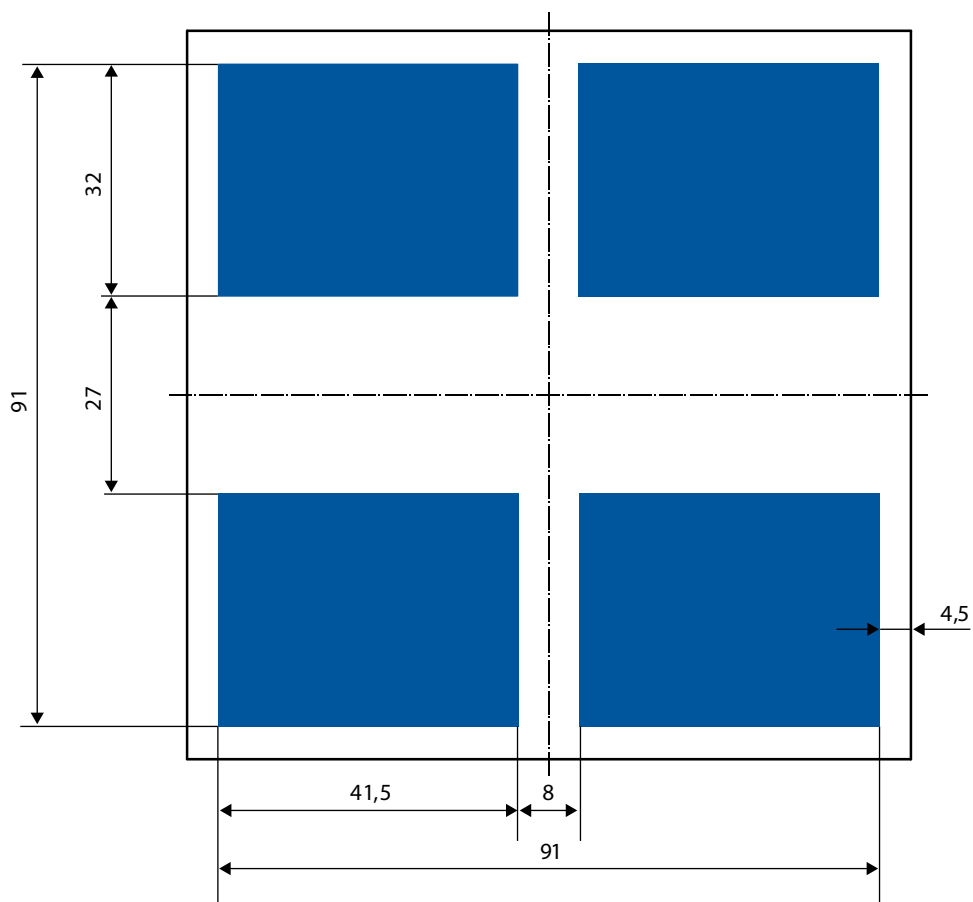


(c) E.9c

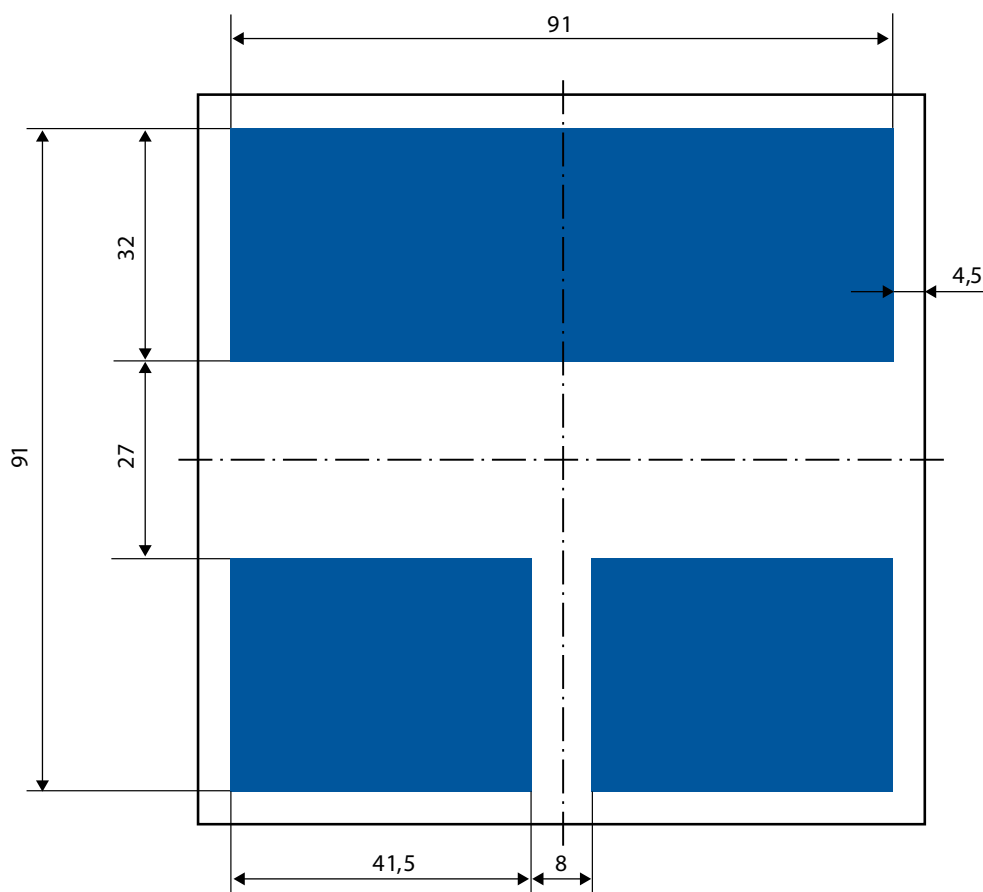


E.10 This waterway is considered to be a tributary of the waterway being approached

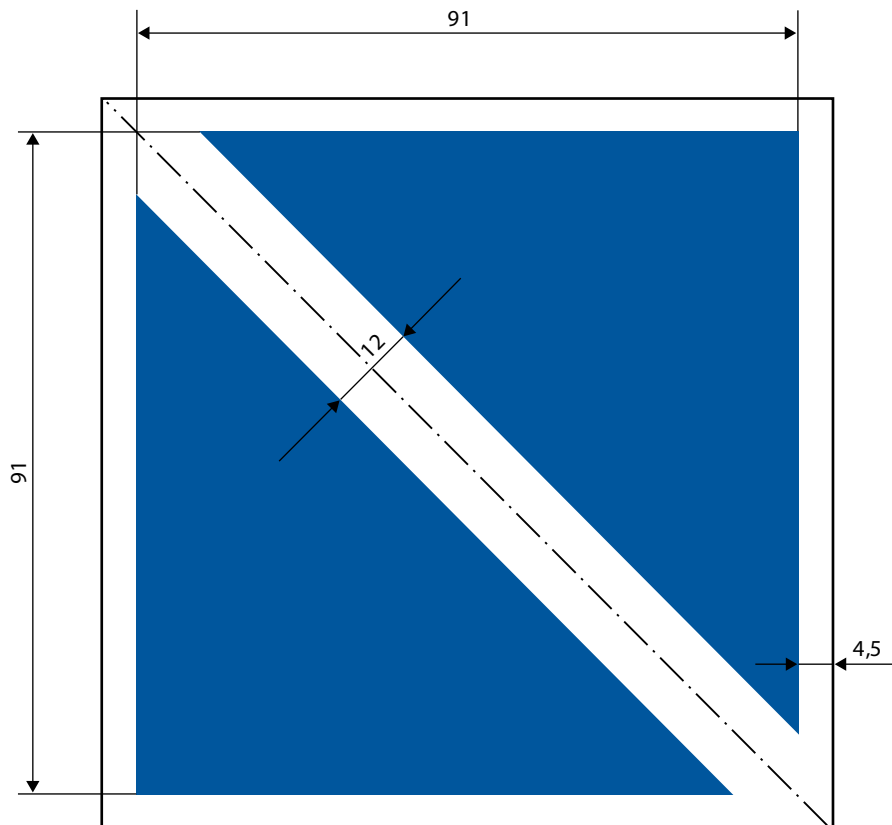
(a) E.10a



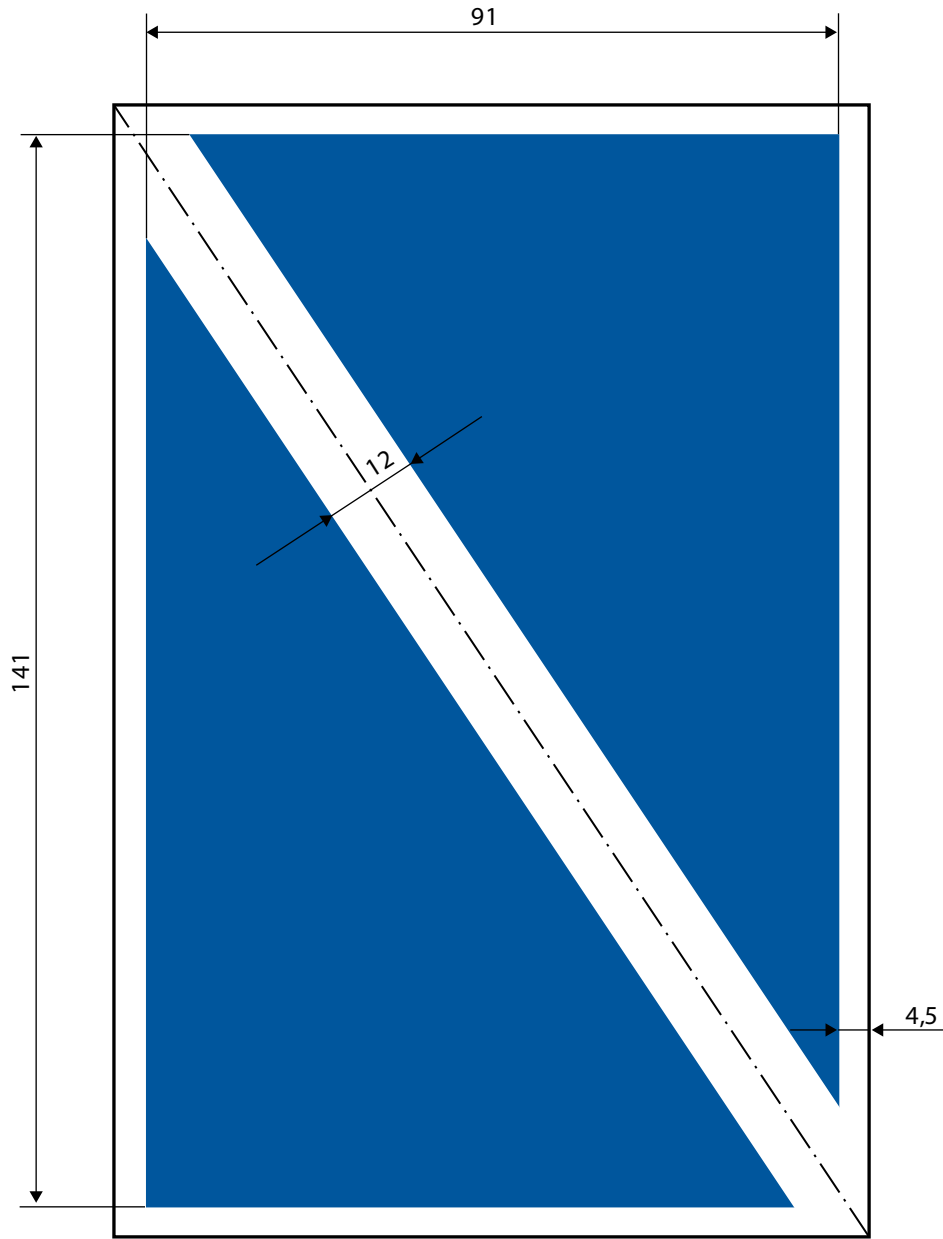
(b) E.10b



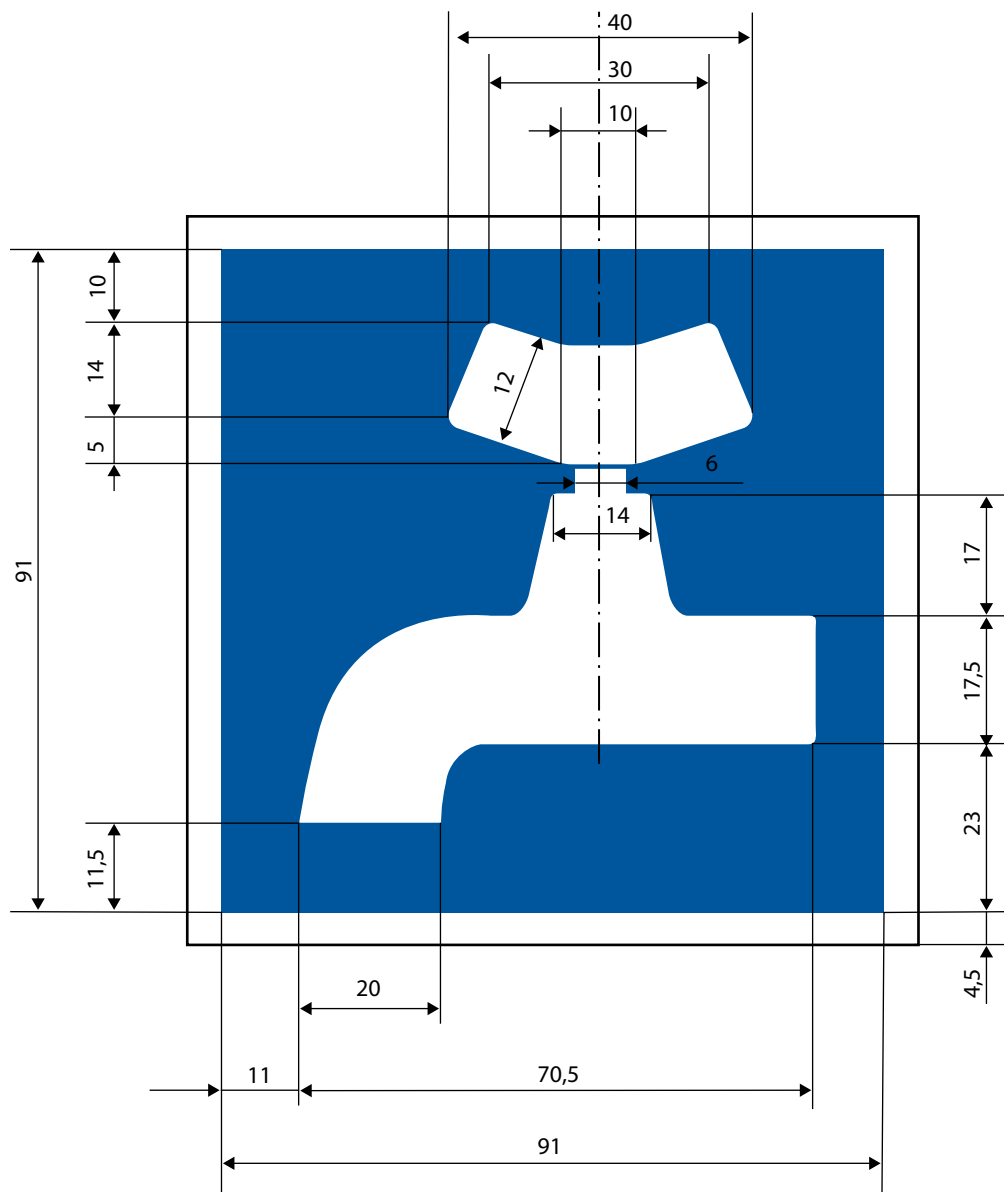
- E.11 End of a prohibition or obligation applying to traffic in one direction only, or end of a restriction
(a) E.11a



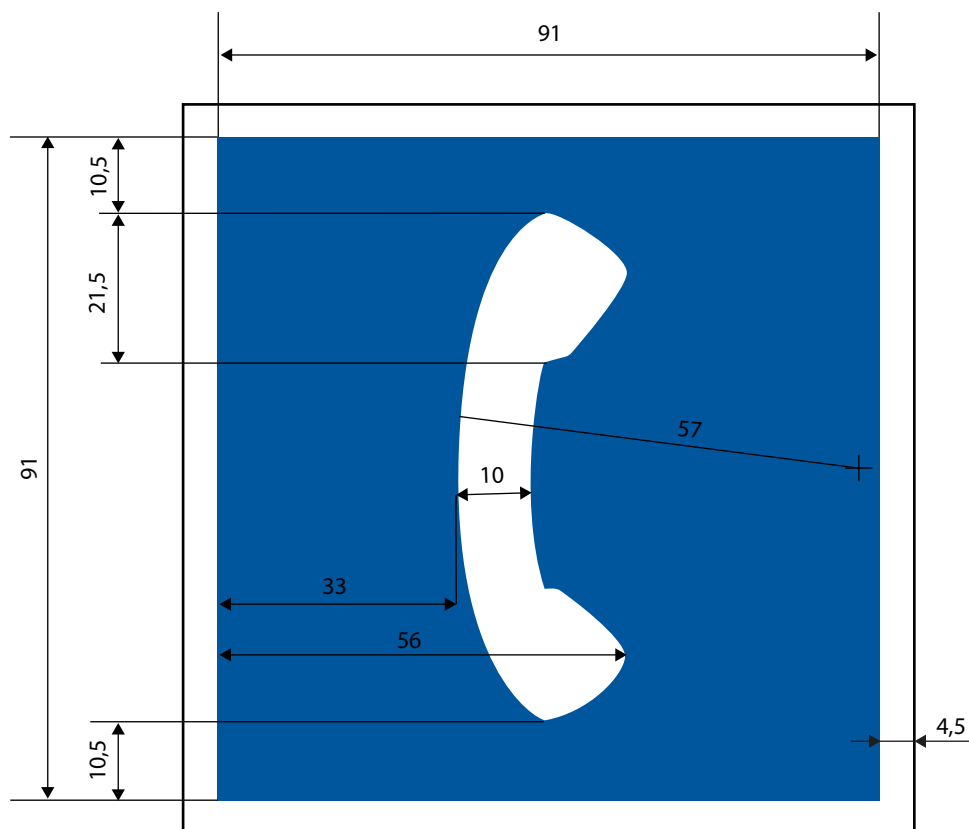
(b) E.11b



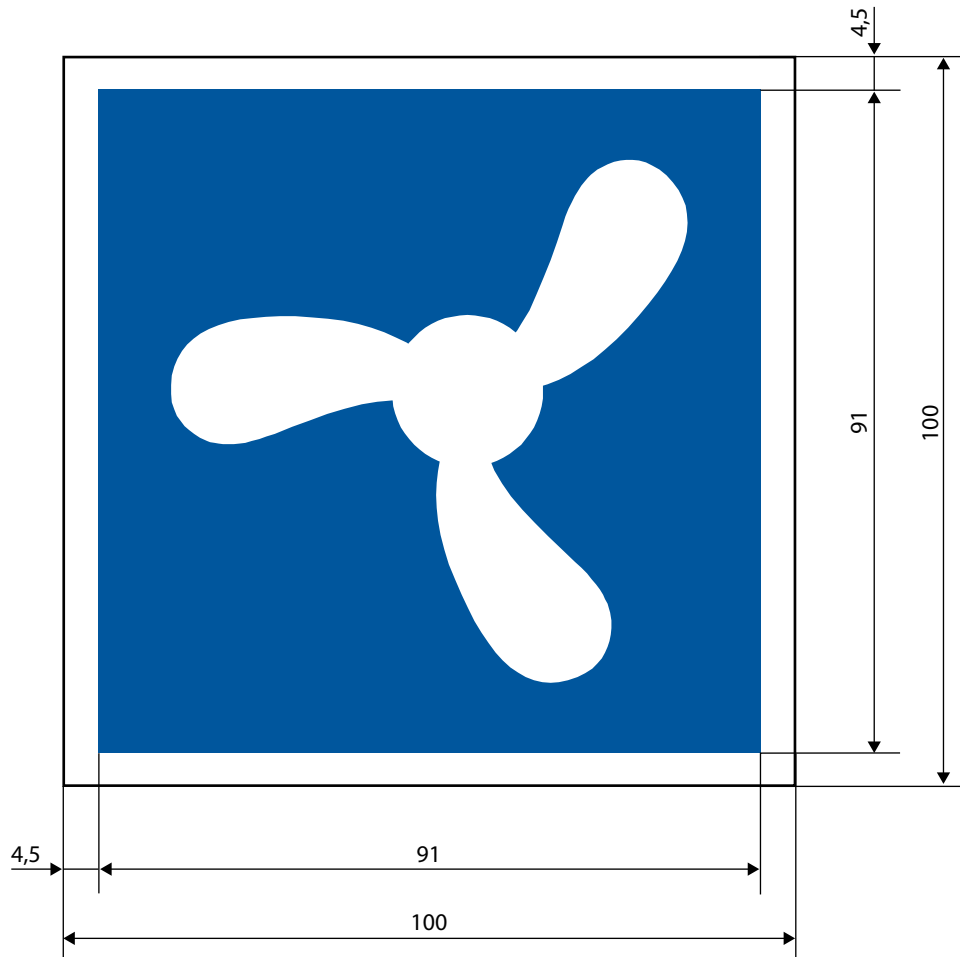
E.13 Drinking-water supply



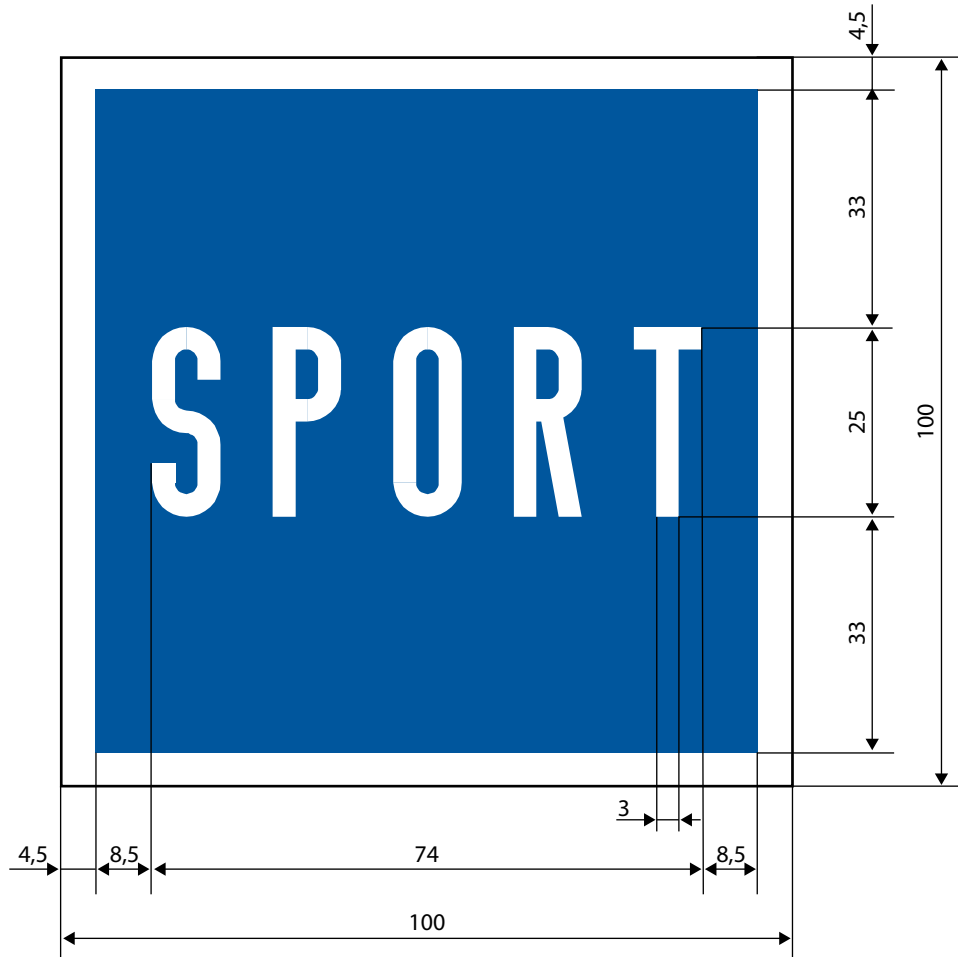
E.14 Telephone



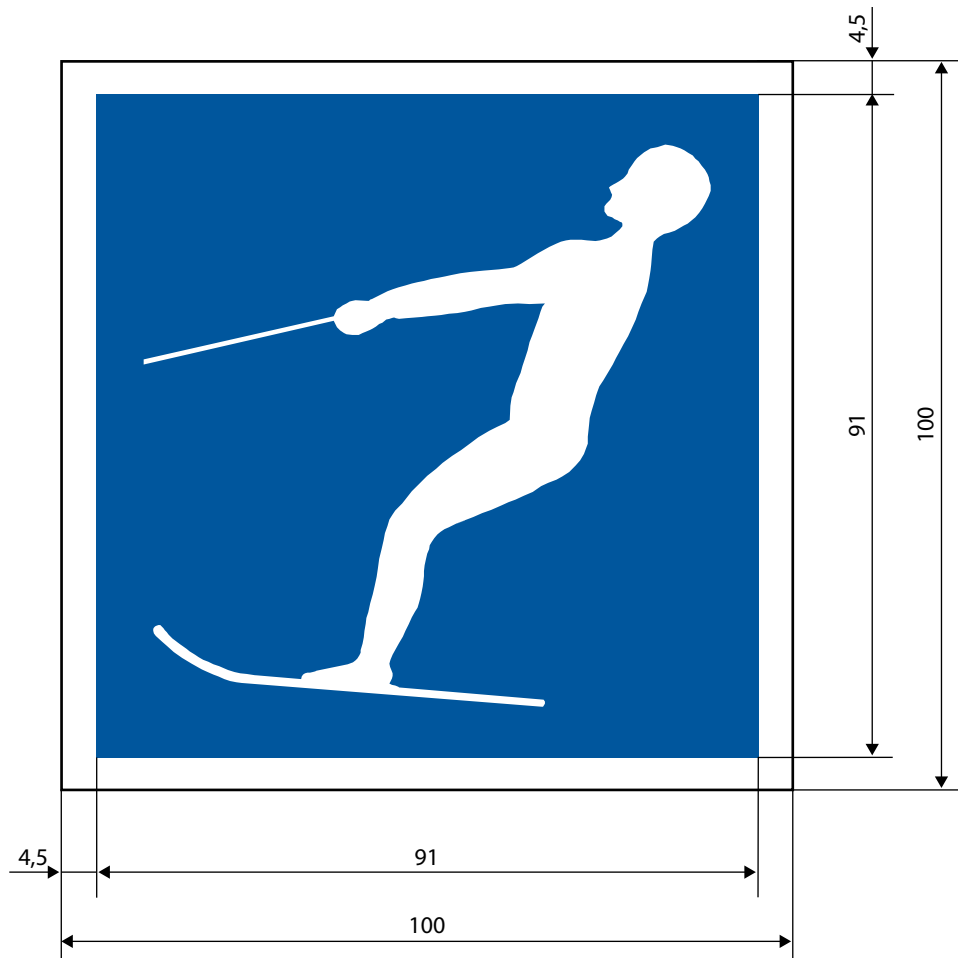
E.15 Motorized vessels permitted



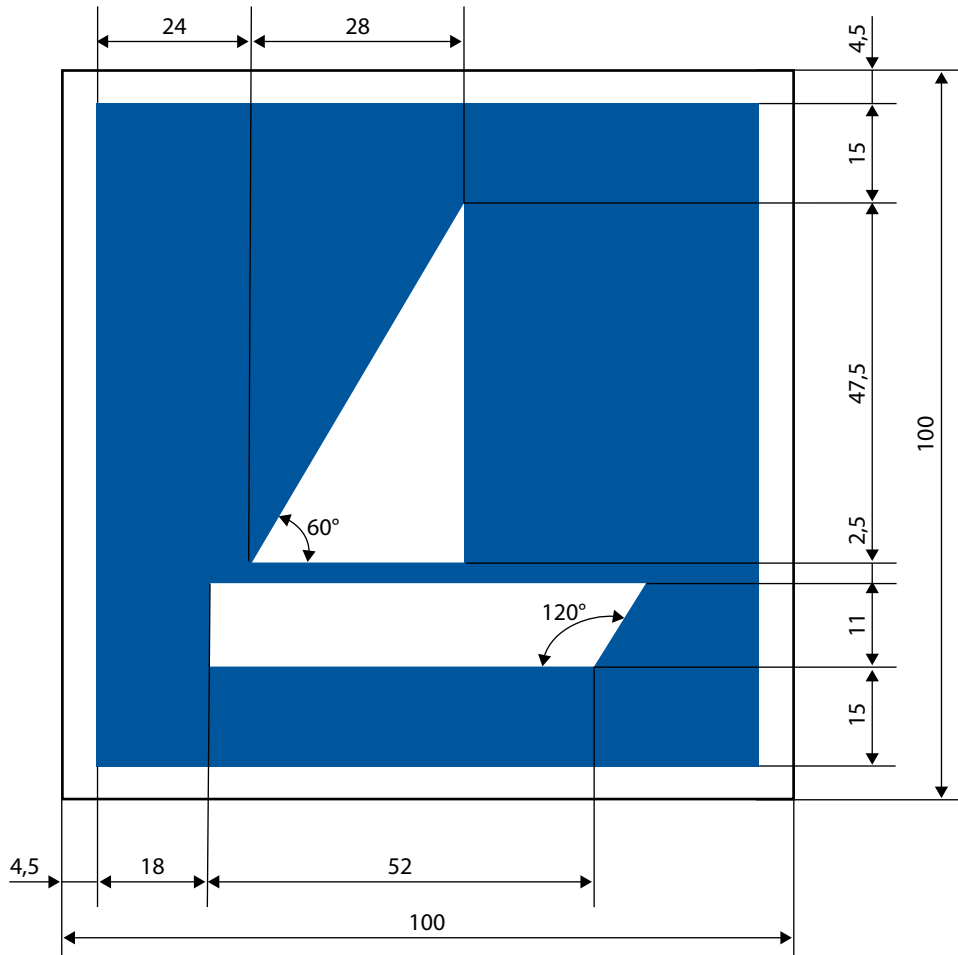
E.16 Sports or pleasure craft permitted



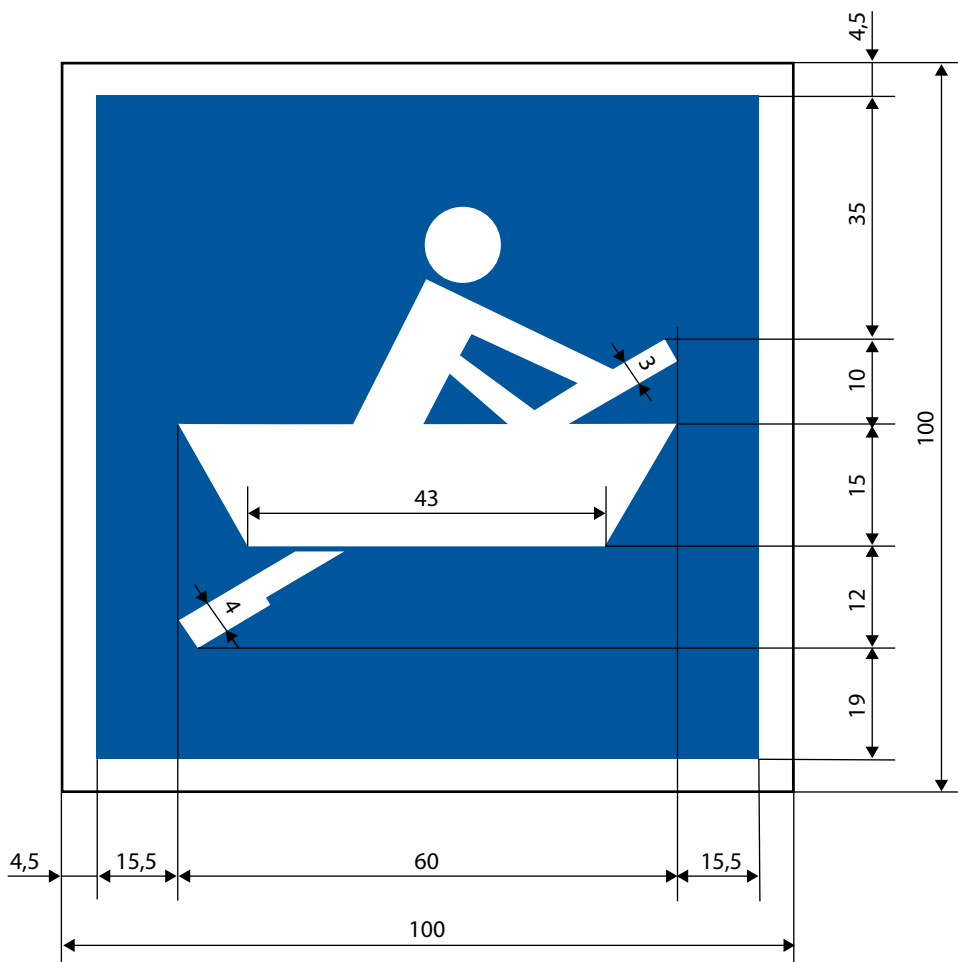
E.17 Water skiing permitted



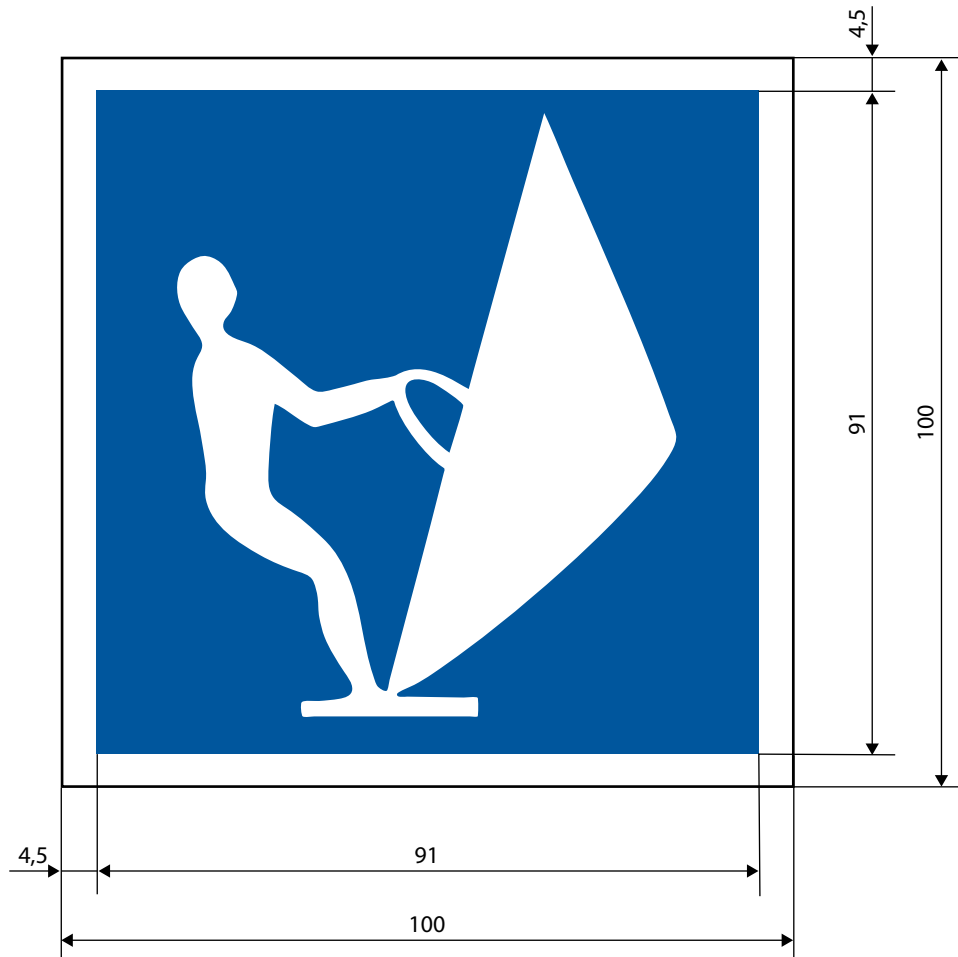
E.18 Sailing vessels permitted



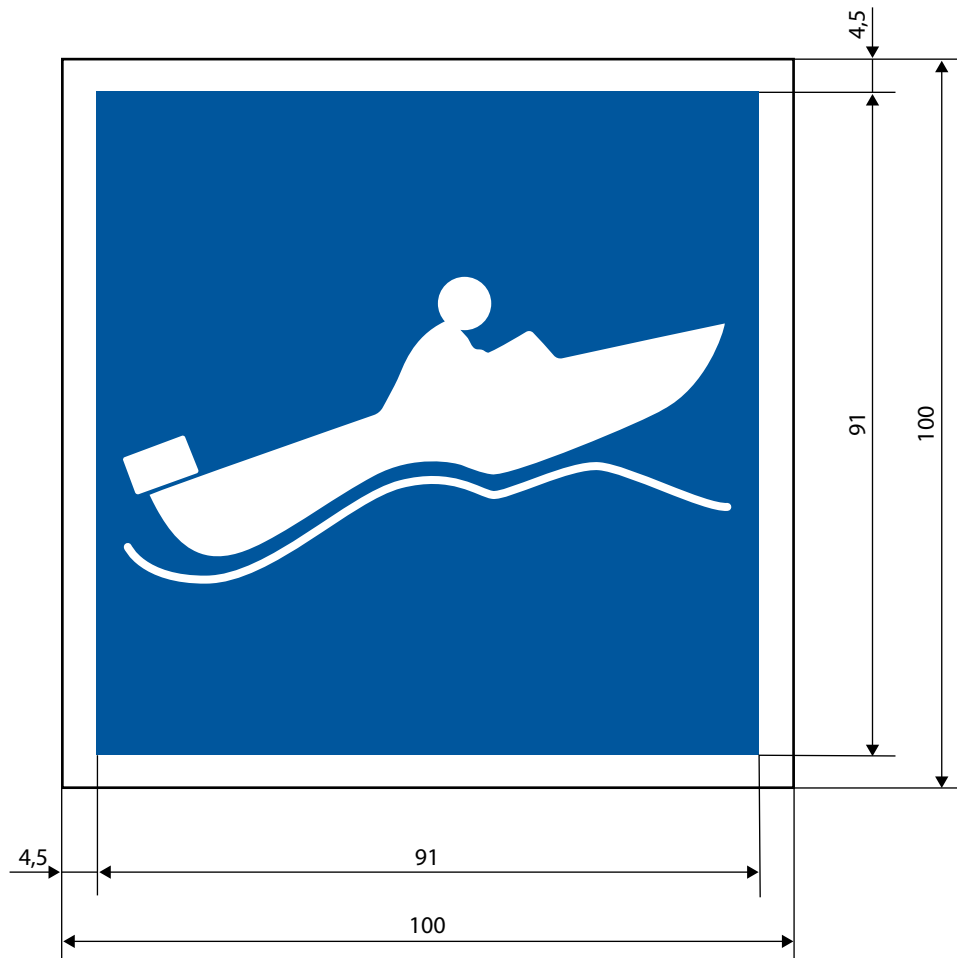
E.19 Craft other than motorized vessels or sailing craft permitted



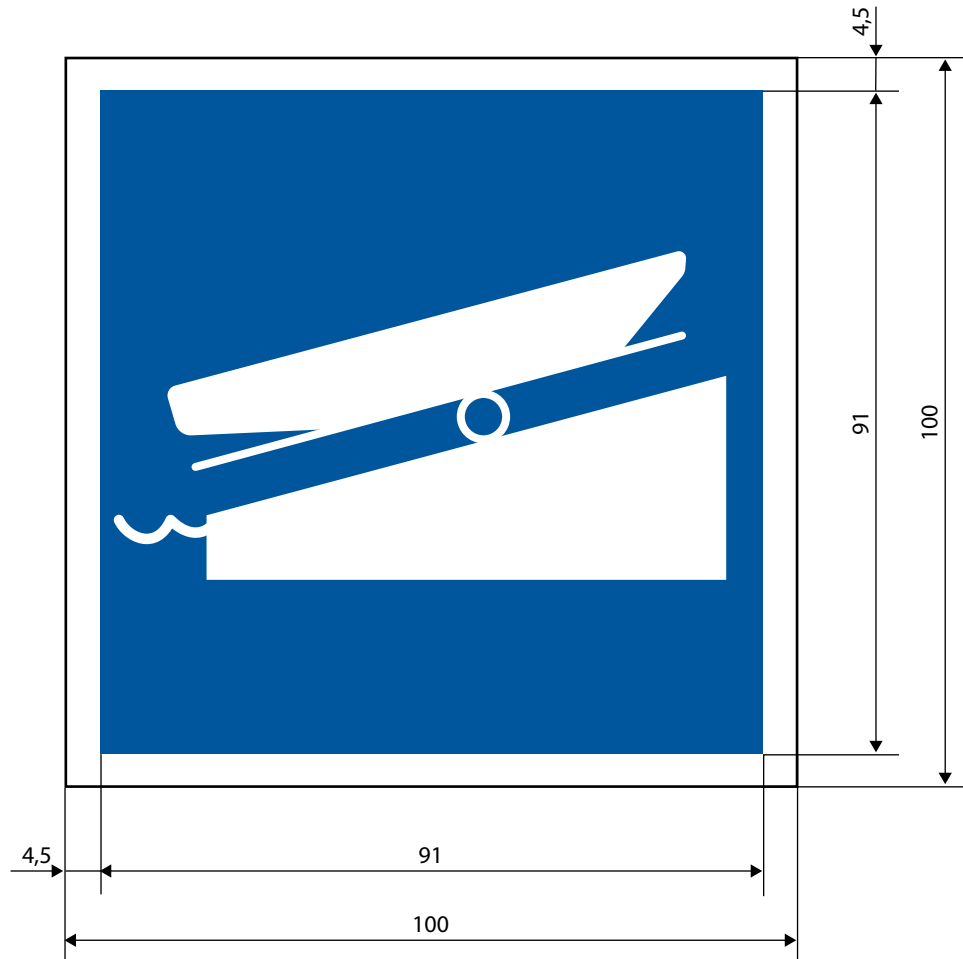
E.20 Use of sailboards permitted



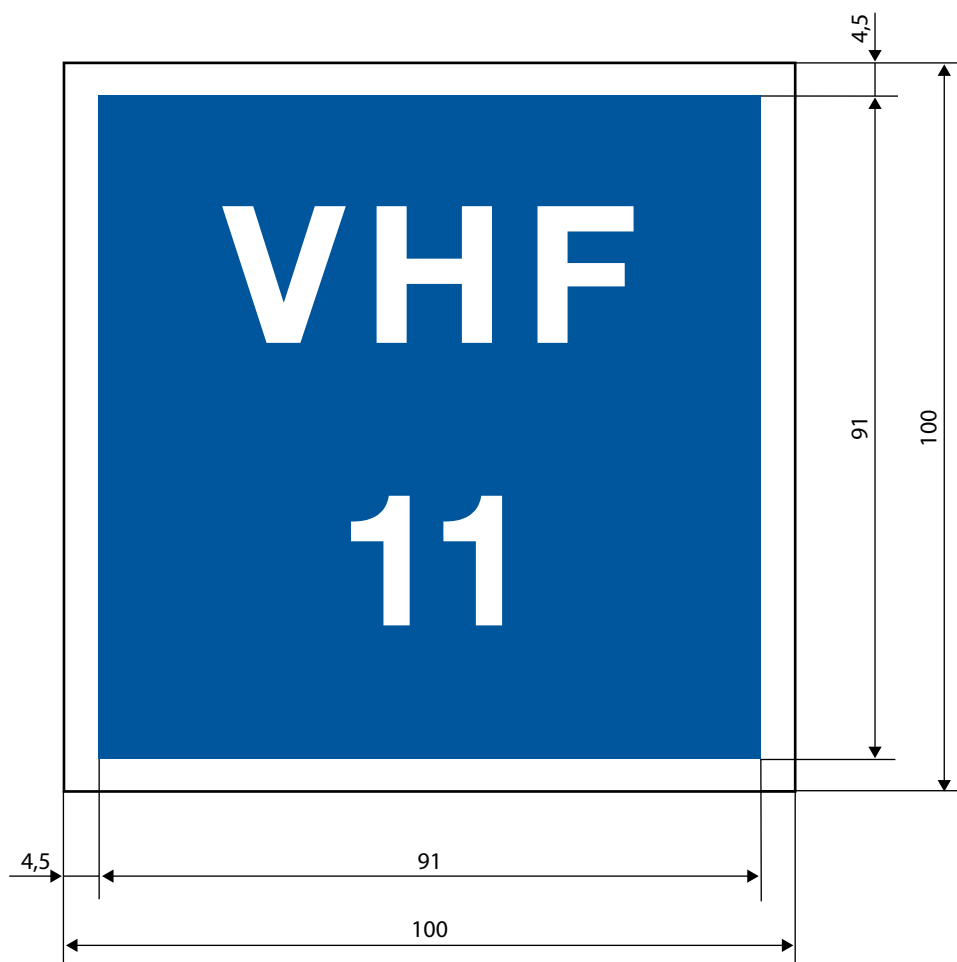
E.21 Zone authorized for high speed navigation of small sport and pleasure craft



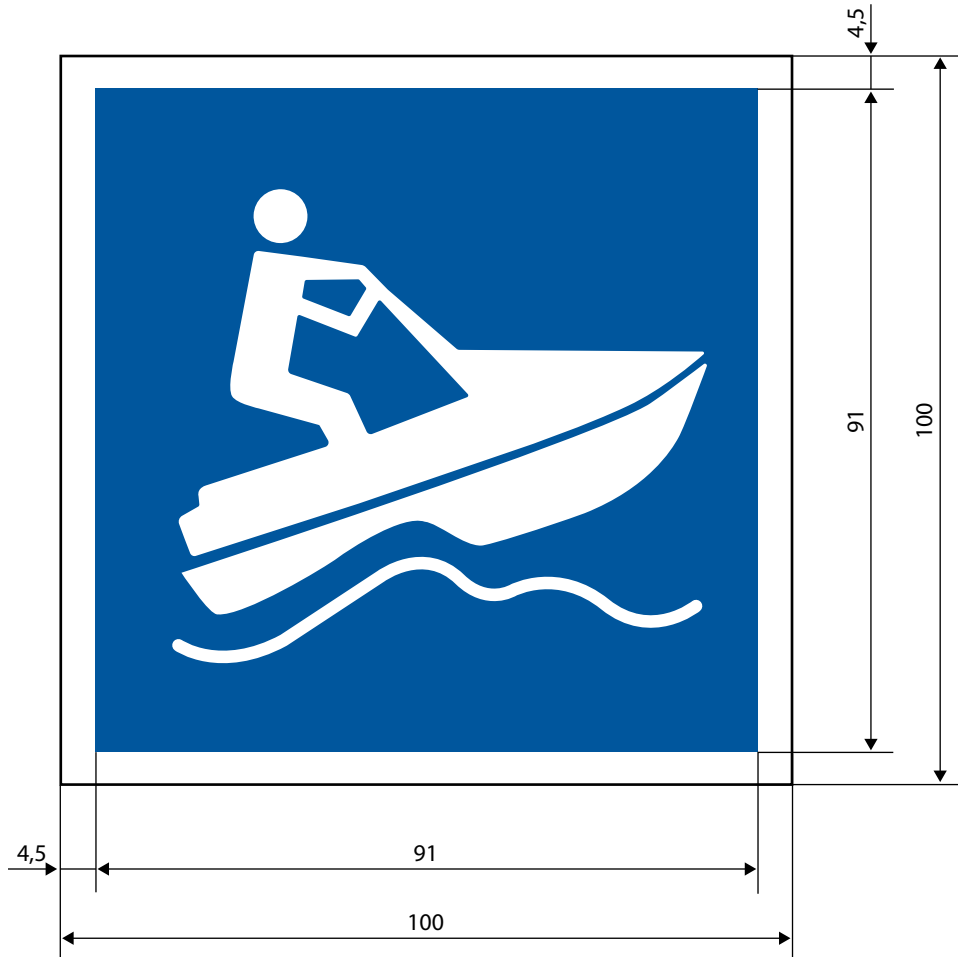
E.22 Launching or beaching of small craft permitted



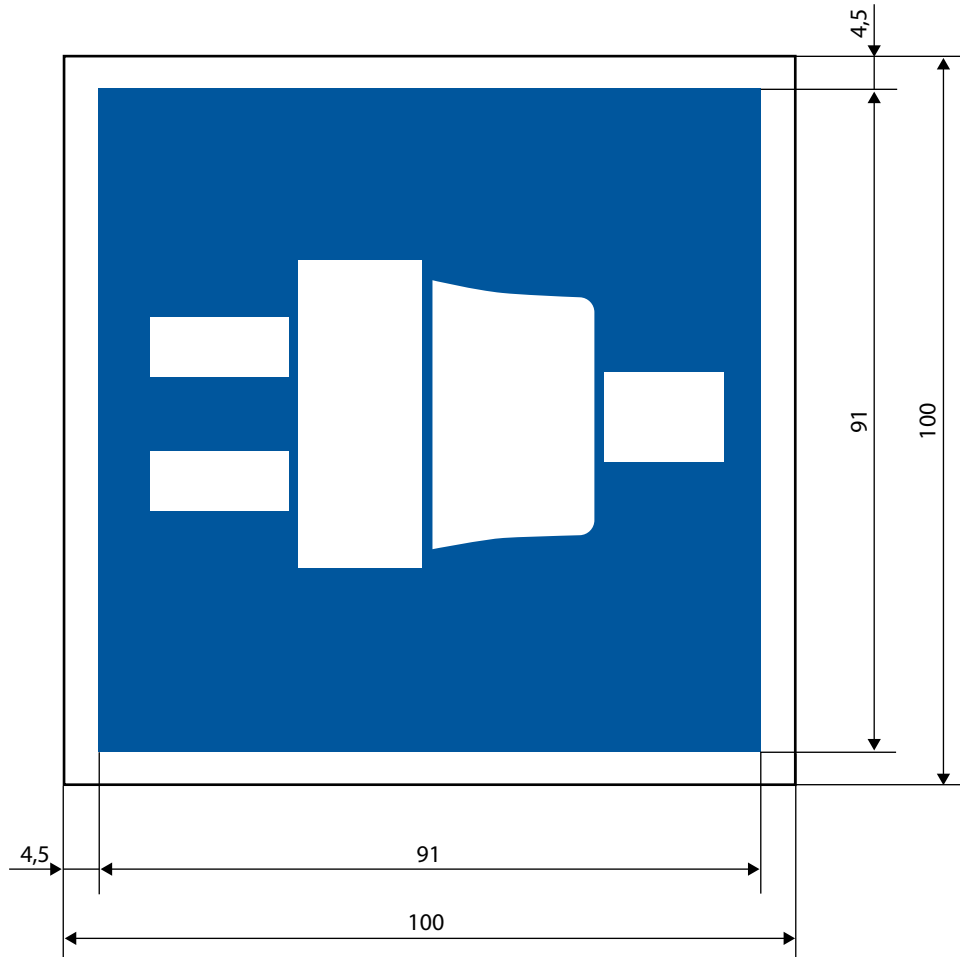
E.23 Possibility of obtaining nautical information by radio-telephone on the channel indicated



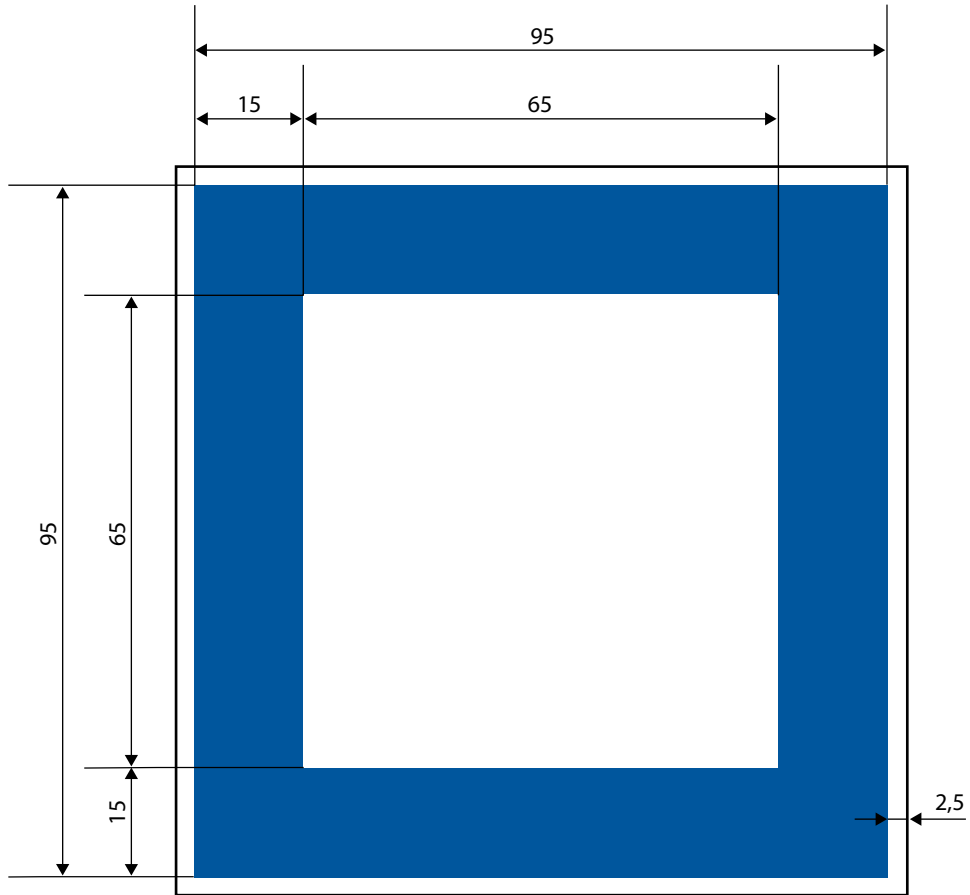
E.24 Water bikes permitted



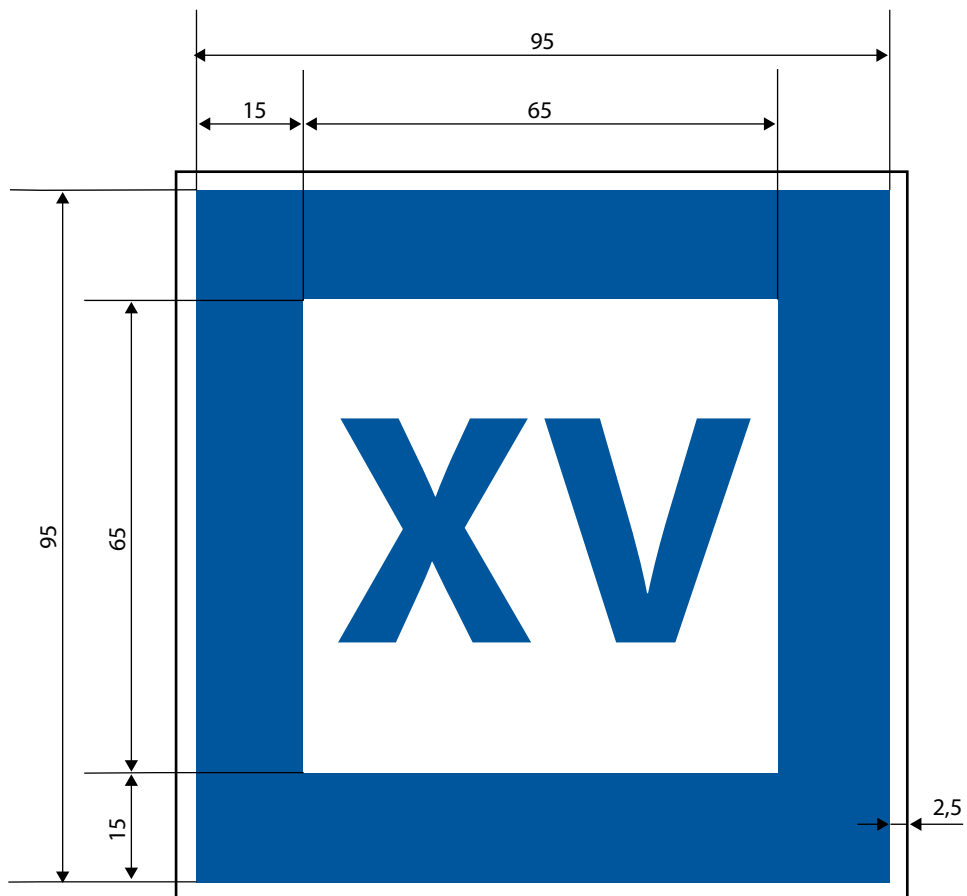
E.25 Electrical power supply point



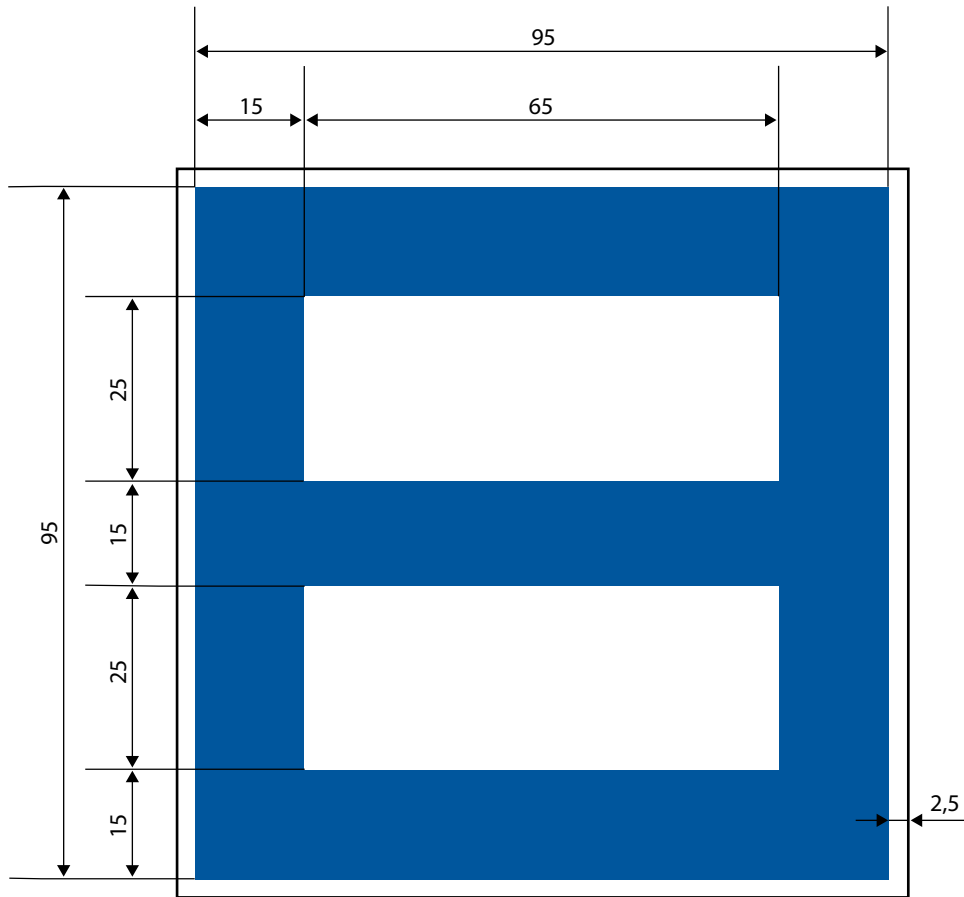
E.26 Winter harbour



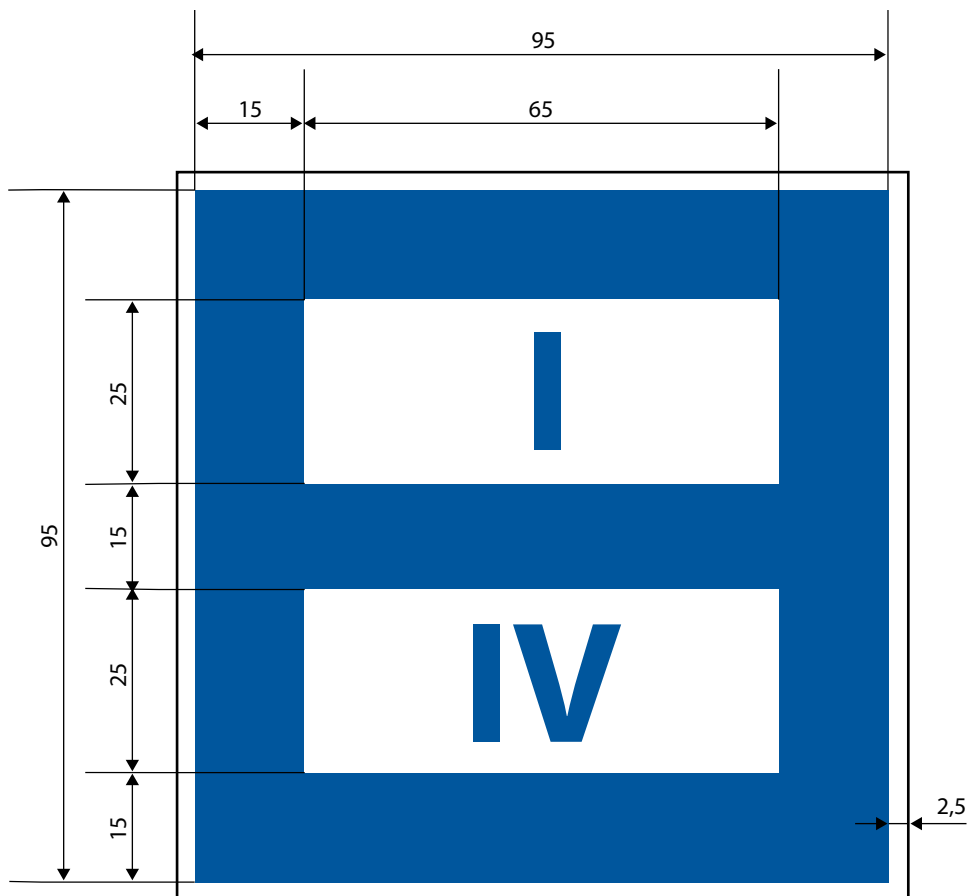
E.26.1 Maximum number of vessels permitted to berth in winter harbour



E.27 Winter shelter



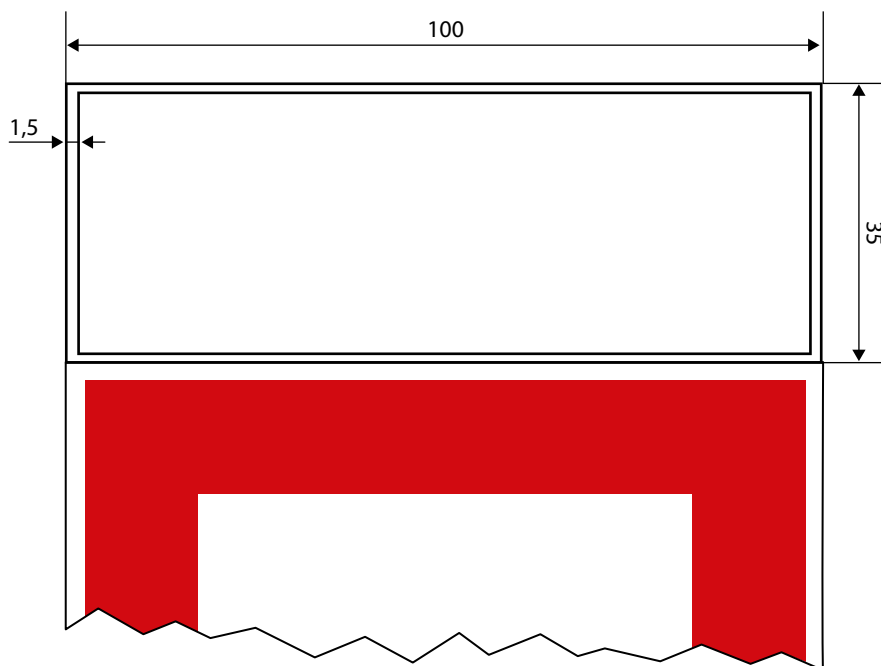
E.27.1 Maximum number of vessels permitted to berth in winter shelter (Maximum number of vessels permitted to berth abreast/ Maximum number of rows of vessels which are berthed abreast)



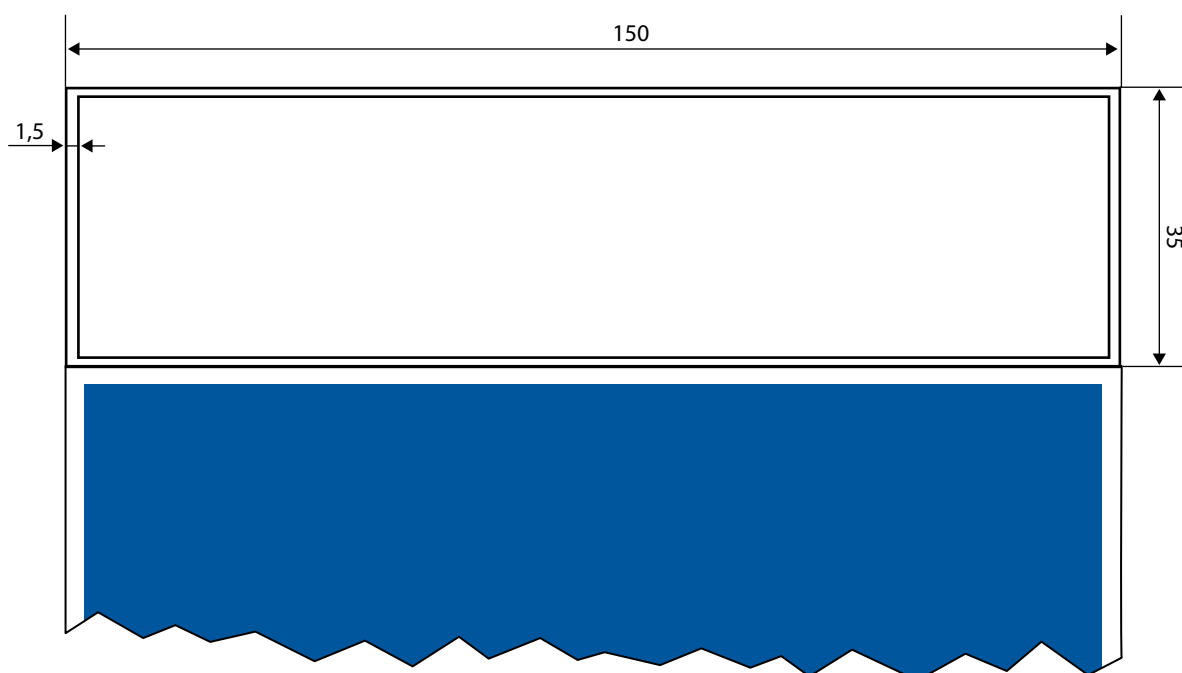
2.2 Auxiliary signs

- A. Panels showing the distance at which the regulation applies or the special feature indicated by the main sign is to be found

Example 1

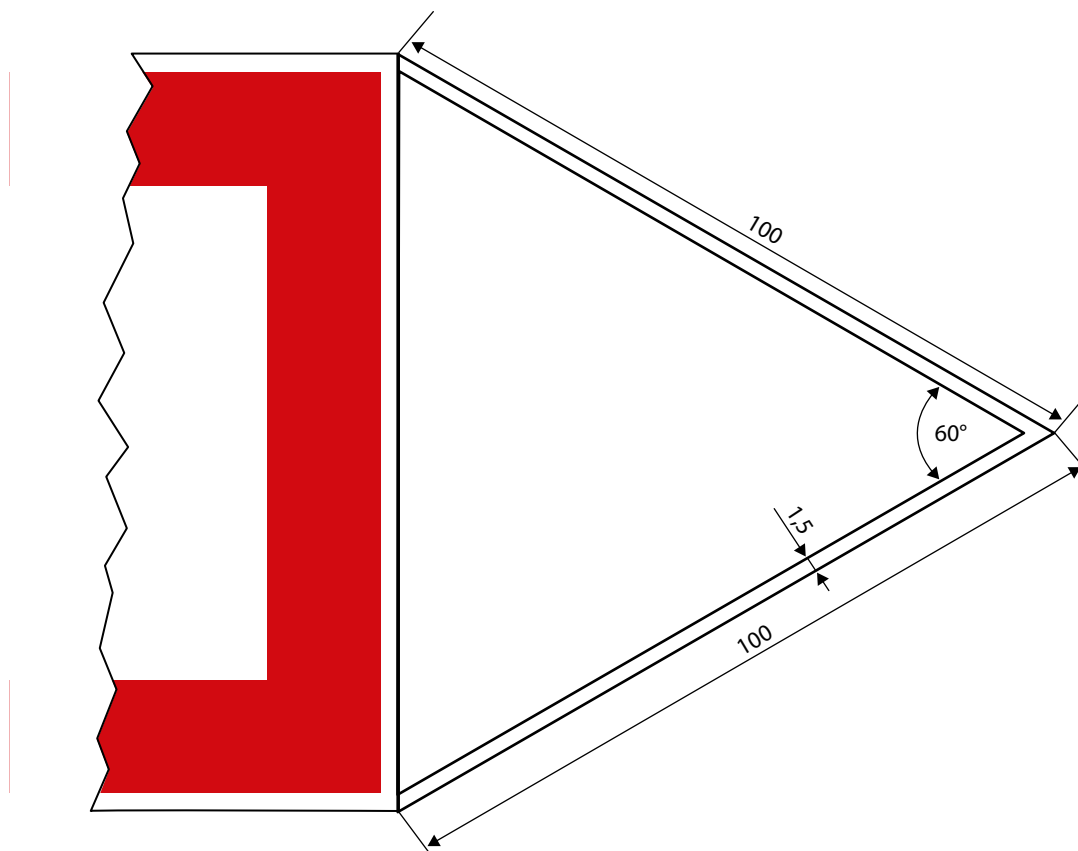


Example 2

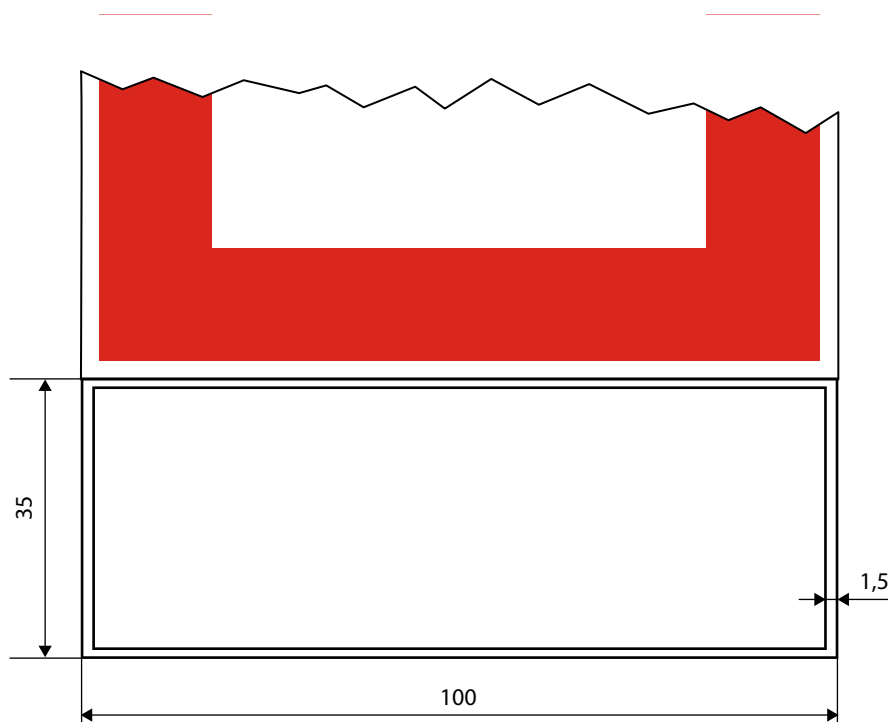


B. Pointers showing the direction of the section to which the main sign applies

Example

**C. Panels giving explanations or additional information**

Example

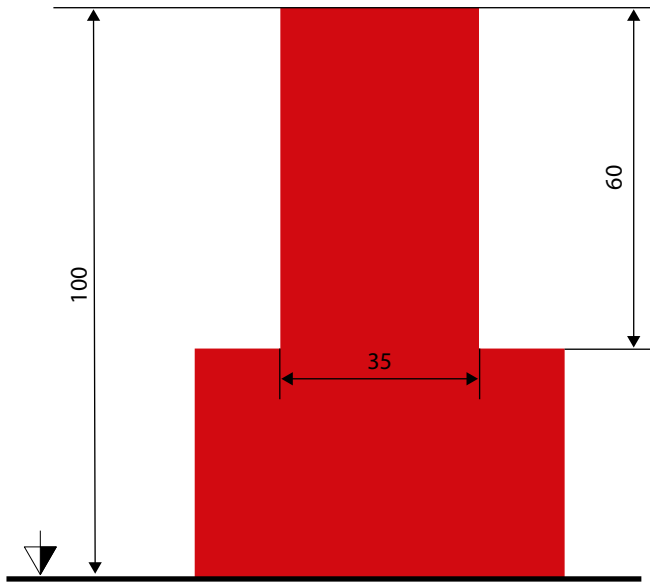


3. Minimal dimensions of the signs contained in annex 8 to the European Code for Inland Waterways

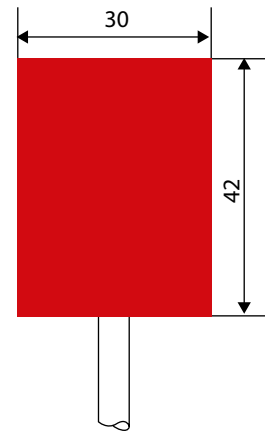
3.1 Buoyage of fairway limits in the waterway

A. Right-hand side of the waterway

1.C Float with a topmark

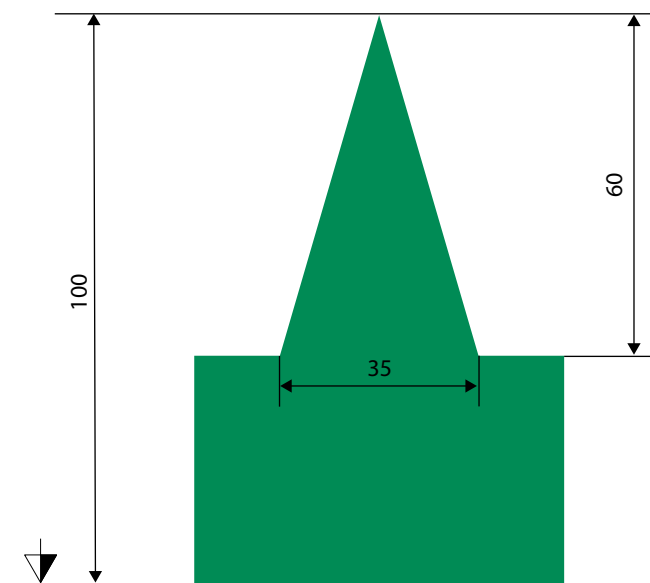


1.D Spar

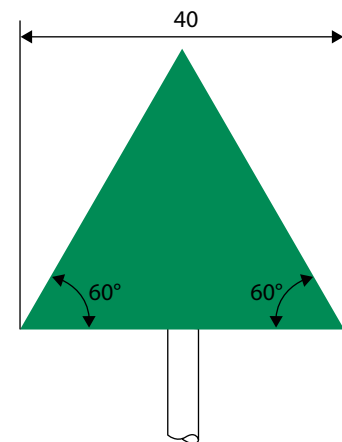


B. Left-hand side of the waterway

2.C Float with a topmark

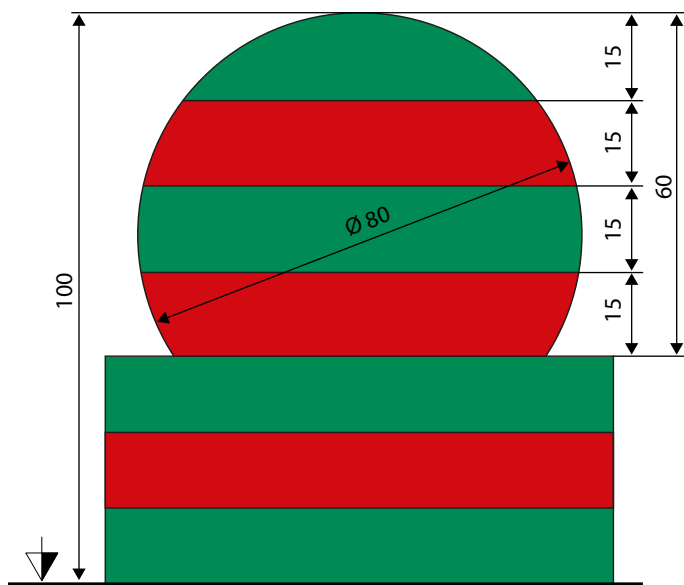


2.D Spar

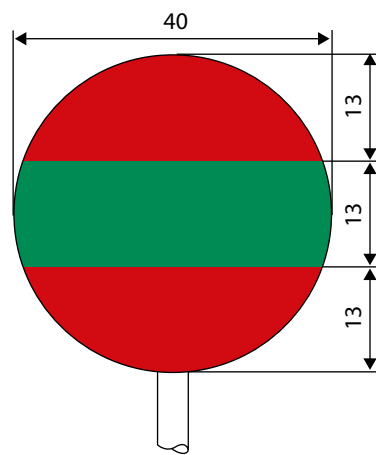


C. *Bifurcation of the waterway*

3.C Float with a topmark



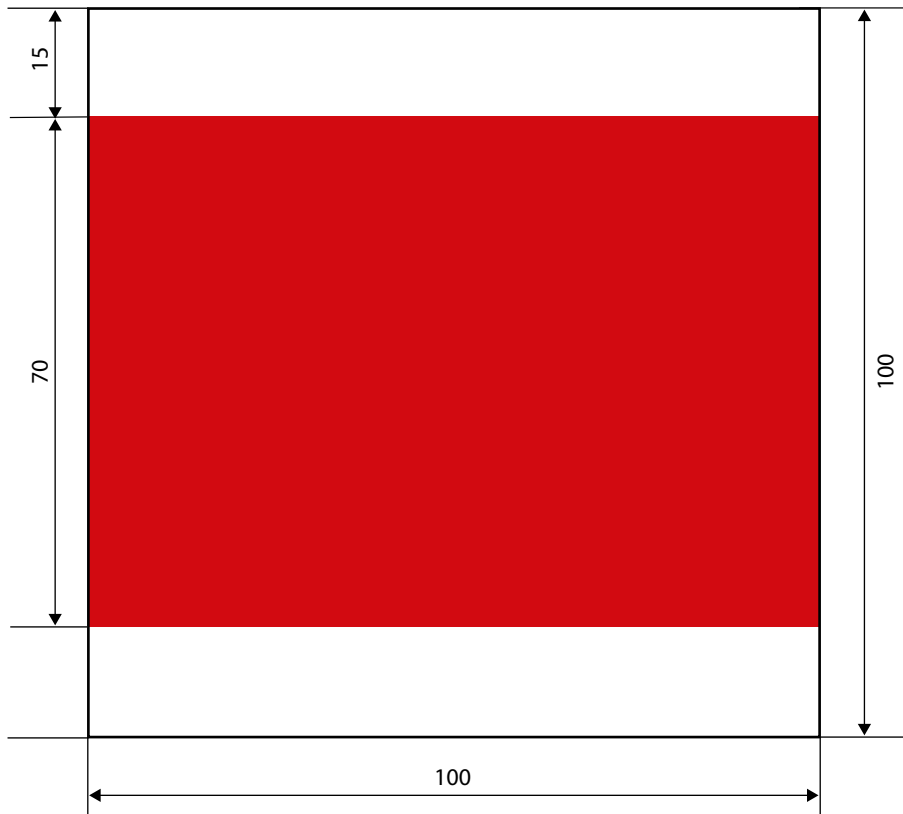
3.D Spar



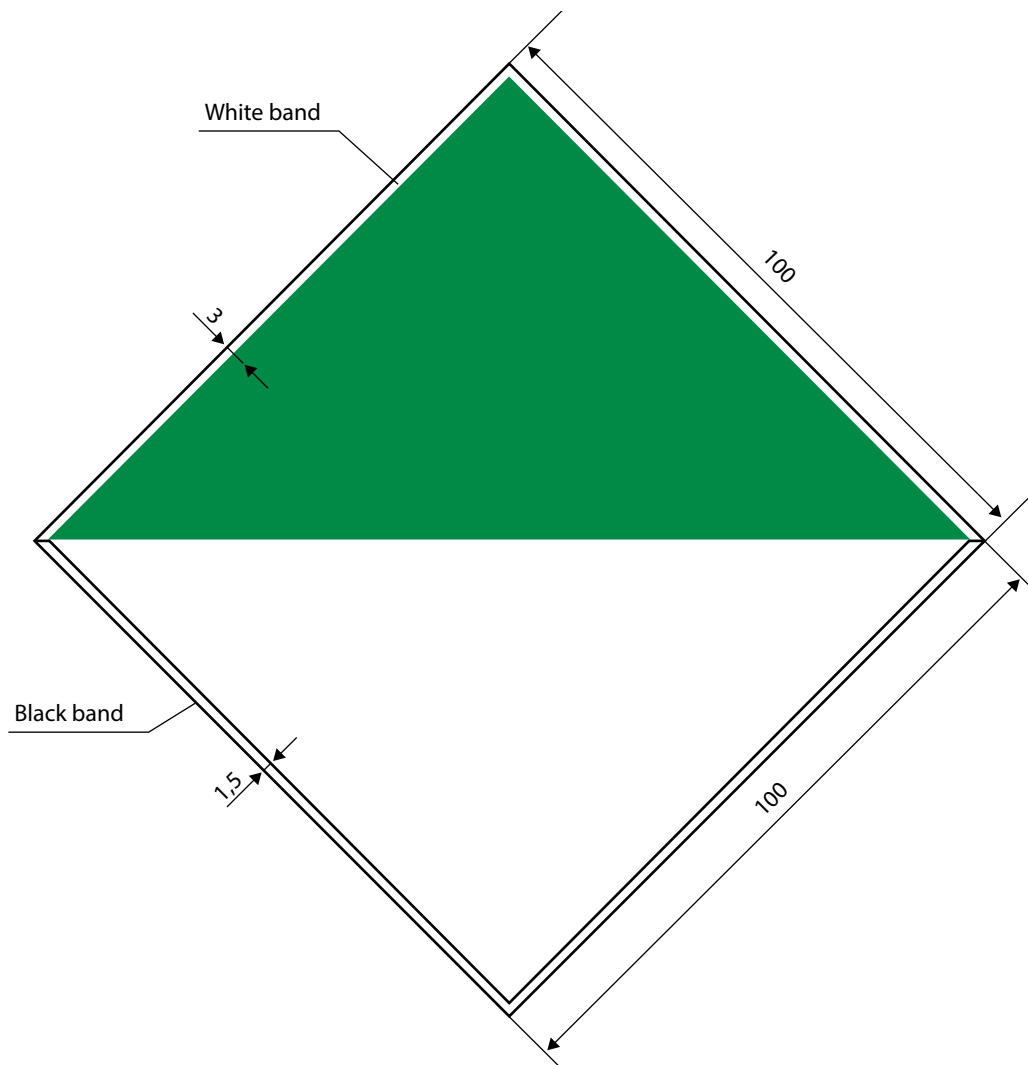
3.2 Bank marks indicating the position of the fairway

A. Bank marks indicating the position of the fairway in relation to the banks

(a) 4.B Channel near the right bank (without light)

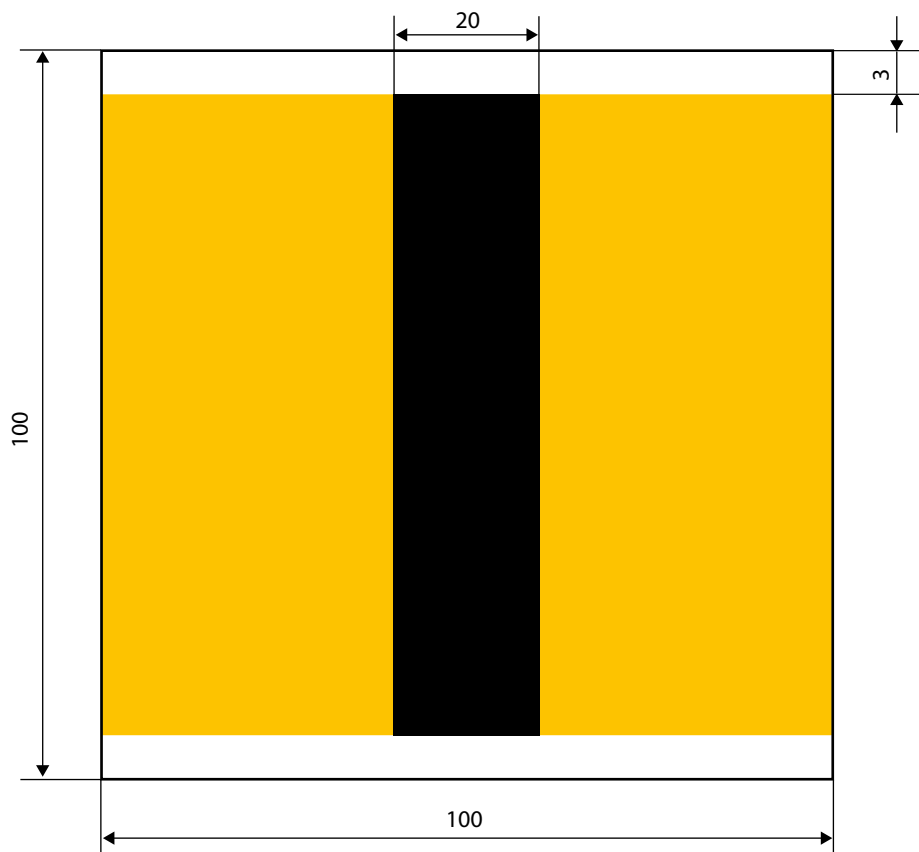


(b) 5.B Channel near the left bank (without light)

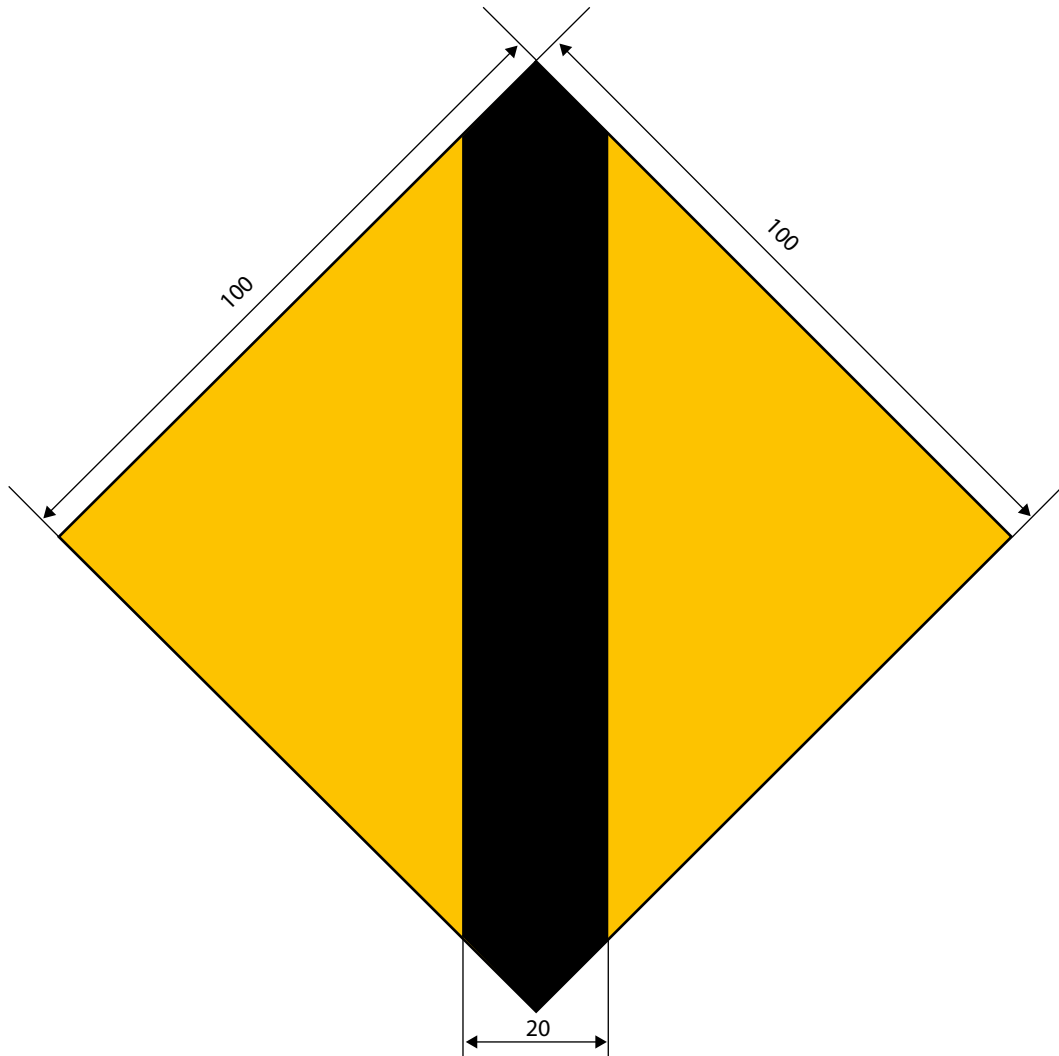


B. Cross-overs

(a) 4.D Right bank (without light)



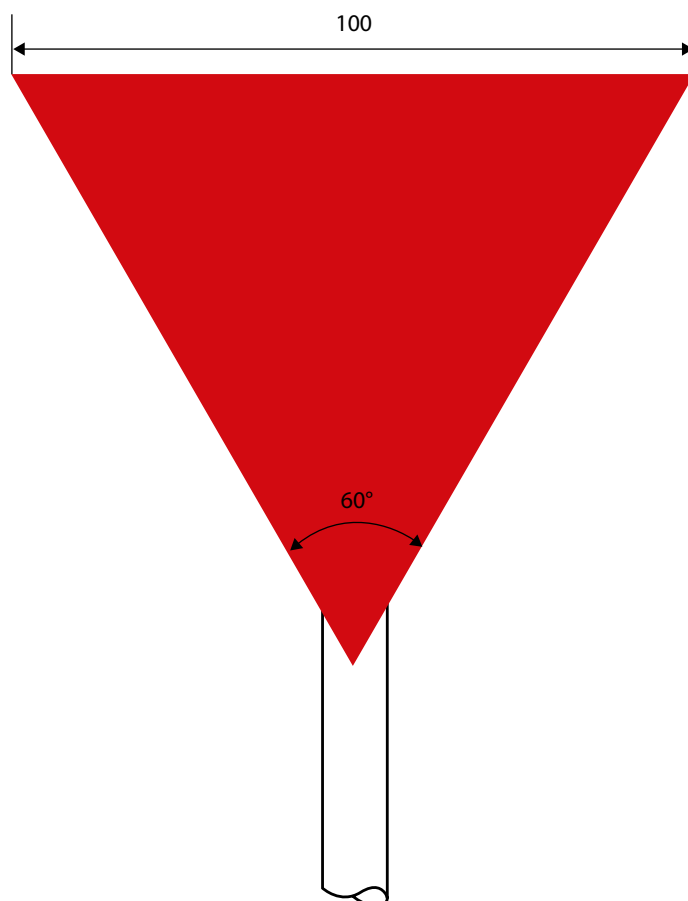
(b) 5.D Left bank (without light)



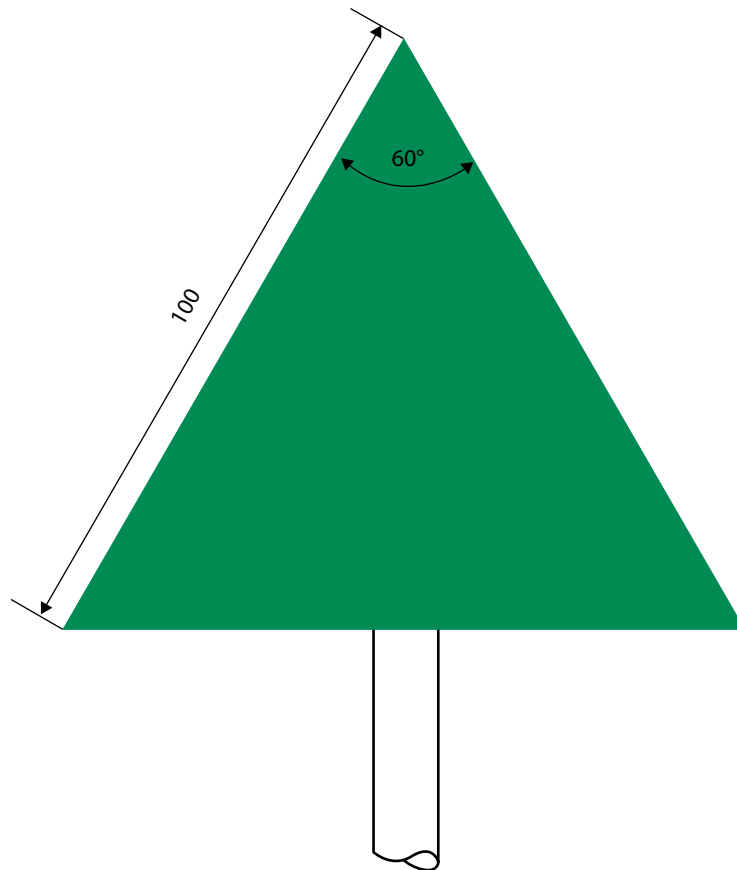
3.3 Buoyage and marking of danger points and obstacles

A. Fixed marks

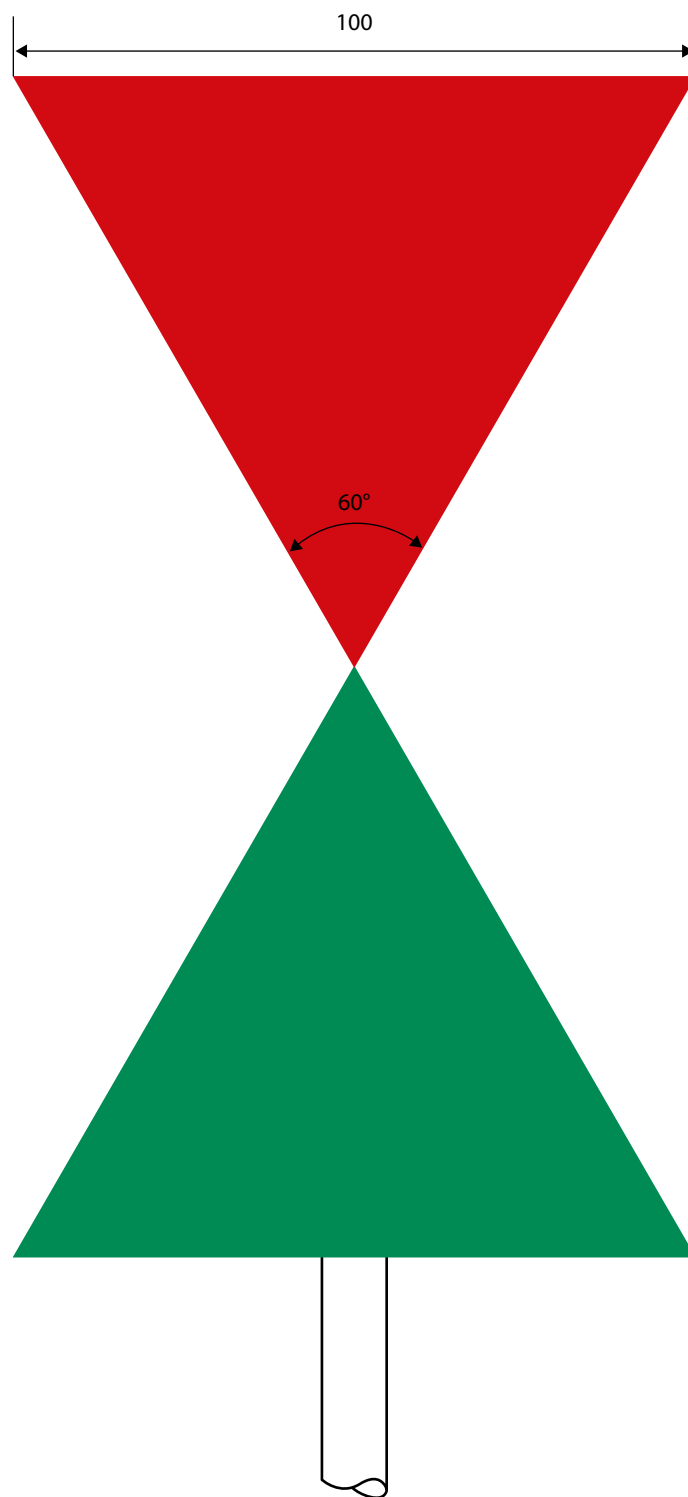
(a) 4.F Right-hand side



(b) 5.F Left-hand side

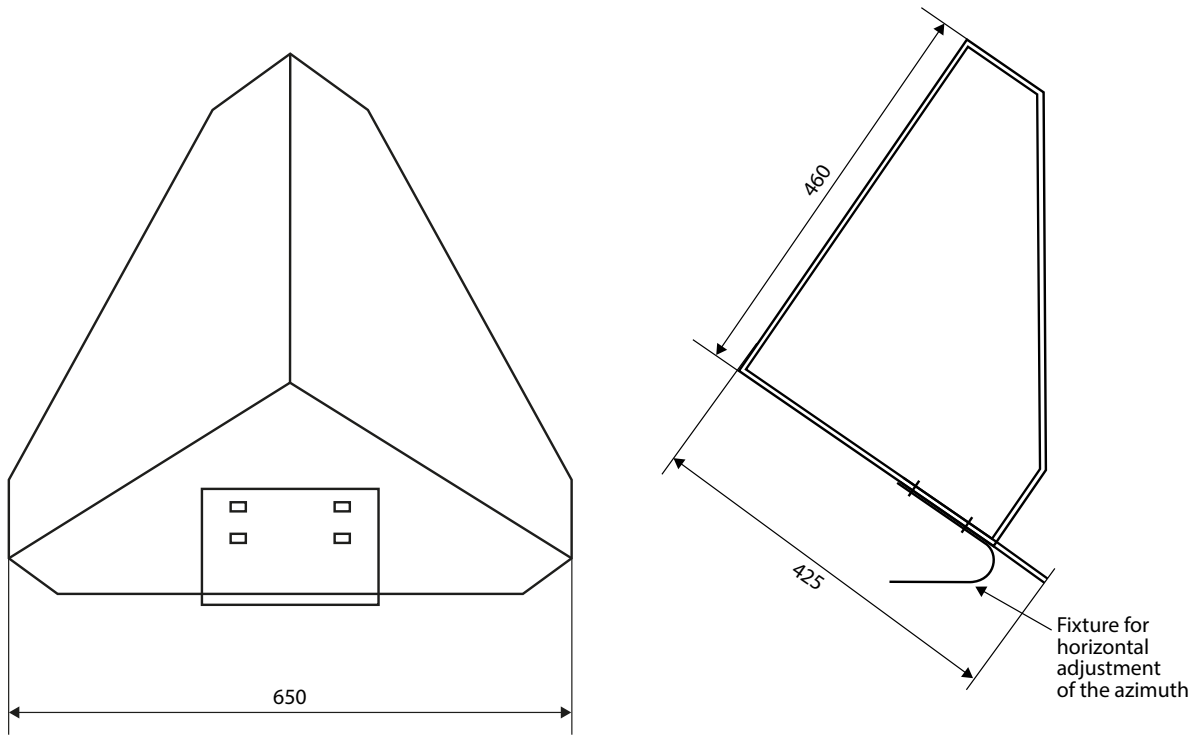


(c) 6.B Bifurcation

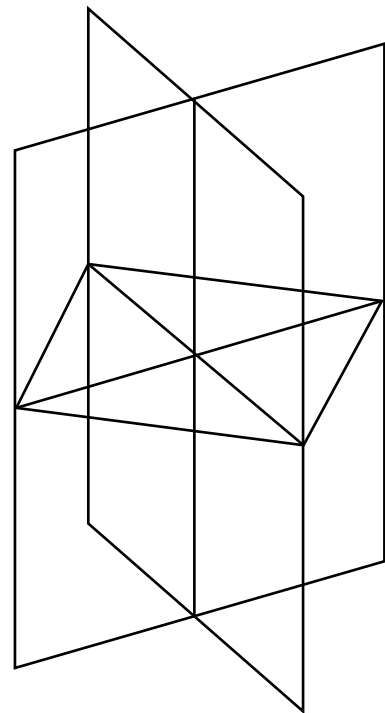
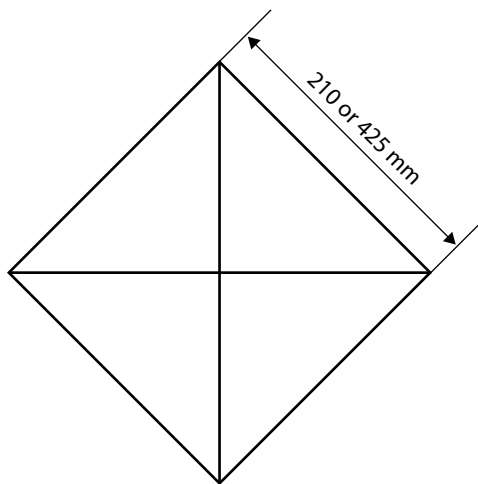
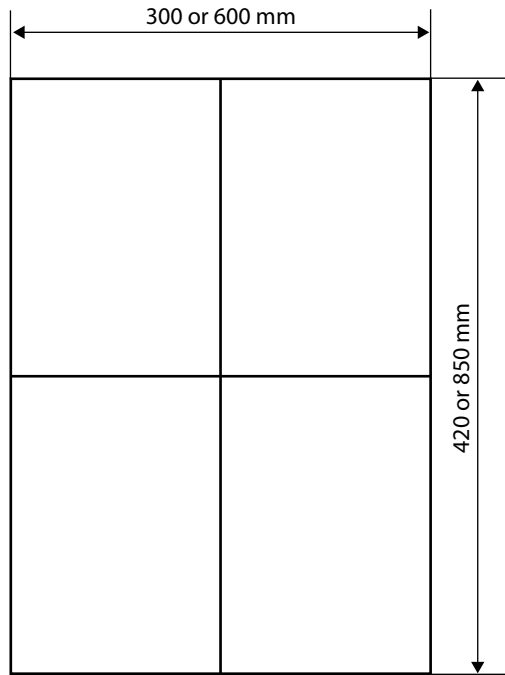


3.4 Radar reflectors on marking signs and signals and navigable passes through bridges

A. Radar reflectors on bridges



B. Radar reflectors on buoys and signs





Appendix 2 - Properties of lights

1. Categories of luminous intensity

Lanterns are classified according to their horizontally emitted photometric luminous intensity I_{ph} in candelas (cd).

By analogy with luminous intensity for lights on board vessels, three distinct categories have been established, according to power.

Table 1

Category	By analogy with light	Intensity of white light [cd]	Intensity of red/green/yellow light [cd]
1	Ordinary	2-9	0.8-3.5
2	Bright	9-35	3.5-20
3	Strong	35-100	20-50

2. Acceptable colours of lights

The colours of lights are described in a standard chromatic diagram pursuant to ISO 11664/CIE S 014. The range of colours accepted in the standard chromatic diagram is determined according to standard CIE S 004/E-2001, Class A.

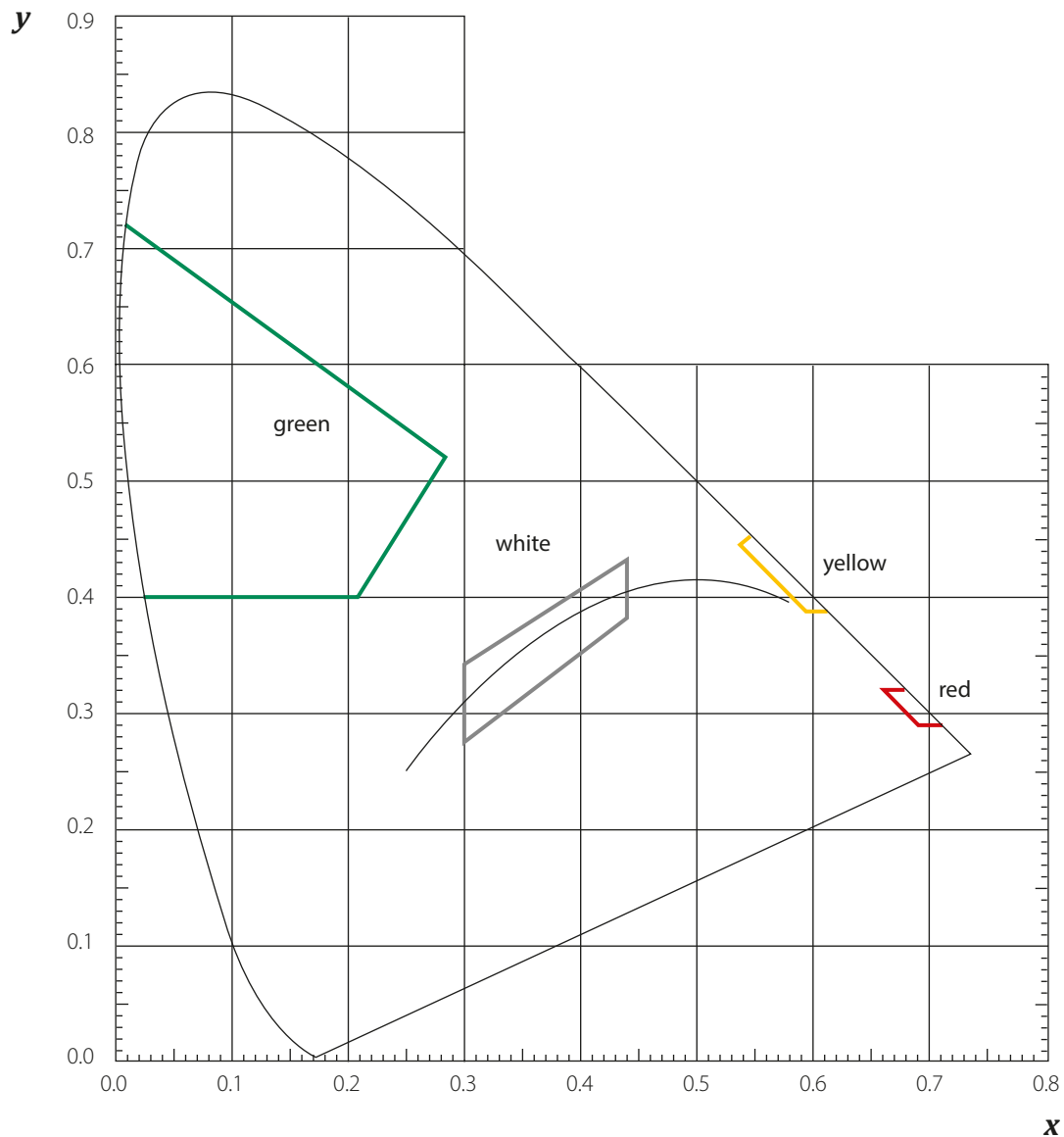
The chromatic coordinates for the acceptable ranges are as follows:

Table 2

Colour		1	2	3	4
White	x	0.300	0.440	0.440	0.300
	y	0.342	0.432	0.382	0.276
Yellow	x	0.536	0.547	0.613	0.593
	y	0.444	0.452	0.387	0.387
Red	x	0.660	0.680	0.690	0.710
	y	0.320	0.320	0.290	0.290
Green	x	0.009	0.284	0.209	0.028
	y	0.720	0.520	0.400	0.400

The yellow/red/green colour ranges are limited in addition by the curve of the colour spectrum. The ranges of colours are set out in figure 1.

Figure 1



3. Calculation of light range

The range of a signal light intended for the guidance of shipping is calculated according to the procedure contained in IALA Recommendation E-200, Part 2 — Calculation, Definition and Notation of Luminous Range, which applies only to signal lights perceived as points by the observer.

Different criteria than those used to establish the range of on-board lights (navigation lights) have been developed for signals intended for the guidance of shipping, which use other values.

The calculations are performed using the following formula:

$$D^2 \times E_l = I_{\text{eff.B}} \times T_M^{\frac{d}{v}}$$

Where

D is the range of light;

$I_{\text{eff.B}}$ is the operational luminous intensity of the lantern;

T_M is the value for calculating visibility (describes the atmospheric transmissivity);

E_t is the established limit of luminosity;

V is the meteorological visibility.

The calculation must be done numerically; the formula cannot be solved according to D .

The parameters given are as follows:

$$T_M = 0.6;$$

$$E_t = 2 \times 10^{-7} \text{ lx for buoys with lights and simple bank lights with no background lighting};$$

$$E_t = 10^{-6} \text{ lx to mark a cross-fairway axis with 2 or 3 lights with no background lighting};$$

$$E_t = 2 \times 10^{-6} \text{ lx for all lights with average background lighting (e.g. in a city)};$$

$$E_t = 2 \times 10^{-5} \text{ lx for all lights with substantial background light (e.g. industrial facilities)};$$

$$V = 1852 \text{ m.}$$

The operational luminous intensity $I_{\text{eff.B}}$ is a derivative of the photometric values I_{ph} according to the following calculations:

$$I_{\text{eff.B}} = b \times k \times I_{\text{ph}}$$

Where $b = 0.75$ is the conventionally accepted loss factor owing to dirt and light source degradation.

The effective intensity of rhythmic lights is taken into account by the degree of transmission k , which is usually calculated according to IALA Recommendation E-200, Part 4 — Determination and Calculation of Effective Intensity.

For the light emitting diodes (LEDs) that are used in most cases and that permit very high frequency commutation, the calculations may be simplified to the following:

$$k = \frac{t}{0.2s + t}$$

Where t equals the shortest time of light for the rhythm of light used (e.g. 0.5 s for “Fkl. 1s” and 2 s for “Glt. 4s”).

Table 3

The typical range with visibility $T_M = 0.6$

Background lighting	No	No	Average	Substantial
Light limit E_t [lx]	2×10^{-7}	10^{-6} (marking of the axis)	2×10^{-6}	2×10^{-5}
Luminous intensity $I_{\text{eff.B}}$ [cd]	Range [m]			
1	1 760	890	650	220
2	2 300	1 200	890	300
5	3 210	1 760	1 320	470
10	4 050	2 300	1 760	650
20	5 010	2 970	2 300	890
50	6 470	4 050	3 210	1 320
100	7 720	5 010	4 050	1 760
200	9 060	6 100	5 010	2 300
500	11 000	9 060	6 470	3 210



Appendix 3 - Colours of reflected light for navigation signs

The colours of light reflected by navigation signs (day markings) must conform with CIE publication No. 39-2 (TC-1.6) 1983 “Recommendations for Surface Colours for Visual Signalling”.

The following is taken from the Recommendations:

- Ordinary colours of materials (standard colours), in this case: red, yellow, green, blue, white and black;
- Fluorescent colours of materials (luminescent in daylight), in this case: red, green.

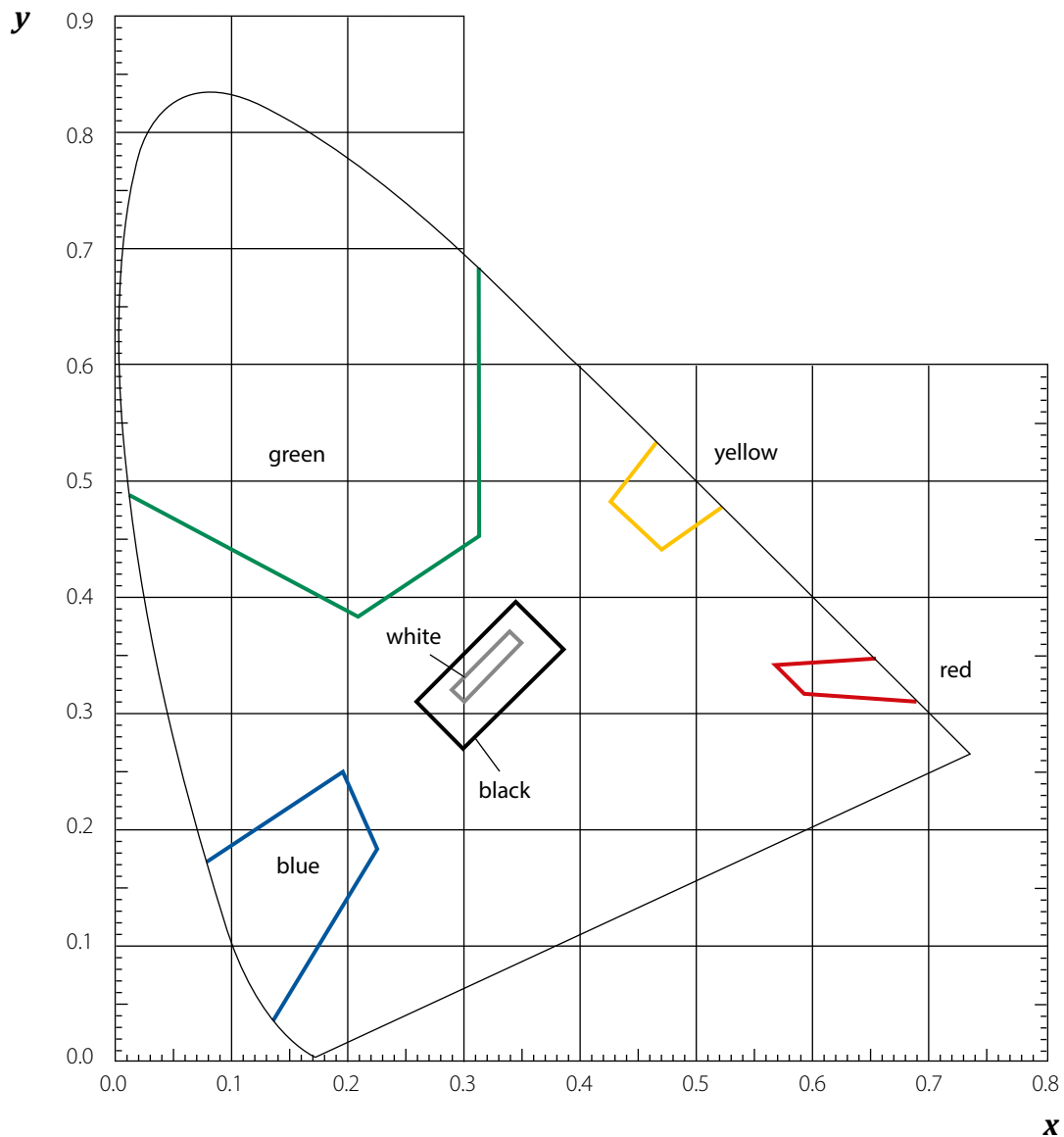
The acceptable colours are given in ranges and with a standard chromaticity diagram, specifying as well the requirements for intensity coefficients (luminance factors). The chromaticity coordinates for the ranges and intensity coefficients are shown in table 1. For colours adjacent to the spectral colour curve, the curve represents their external limit.

Table 1

<i>Colour of the reflected light</i>	<i>Intensity coefficient</i>	<i>1</i>		<i>2</i>		<i>3</i>		<i>4</i>	
<i>Standard colours</i>		<i>x</i>	<i>y</i>	<i>x</i>	<i>y</i>	<i>x</i>	<i>y</i>	<i>x</i>	<i>y</i>
Red	> 0.07	0.690	0.310	0.595	0.315	0.569	0.341	0.655	0.345
Yellow	> 0.45	0.522	0.477	0.470	0.440	0.427	0.483	0.465	0.534
Green	> 0.10	0.313	0.682	0.313	0.453	0.209	0.383	0.013	0.486
Blue	> 0.05	0.078	0.171	0.196	0.250	0.225	0.184	0.137	0.038
White	> 0.75	0.350	0.360	0.300	0.310	0.290	0.320	0.340	0.370
Black	< 0.03	0.385	0.355	0.300	0.270	0.260	0.310	0.345	0.395
<i>Colours luminescent in daylight</i>		<i>x</i>	<i>y</i>	<i>x</i>	<i>y</i>	<i>x</i>	<i>y</i>	<i>x</i>	<i>y</i>
Red	> 0.25	0.690	0.310	0.595	0.315	0.569	0.341	0.655	0.345
Green	> 0.25	0.313	0.682	0.313	0.453	0.209	0.383	0.013	0.486

Figure 1 shows the admissible colour ranges on the standard chromaticity diagram. The ranges for ordinary colours and those that are luminescent in daylight (red/green) are identical; the colours differ only in their intensity coefficients.

Figure 1



A simplified description of the admissible colours can be presented using the RAL numbers from the internationally recognized RAL-Classic colour system.³

The colours below correspond with the CIE Recommendations and are preferred for use in transport technologies.

³ www.ralcolor.com, www.ral-farben.de.

Table 2

<i>Number</i>	<i>Designation</i>	<i>Recommended use</i>
RAL 1023	Traffic yellow	Traffic signs, buoys
RAL 3020	Traffic red	Traffic signs
RAL 3024	Luminous red	Buoys, strongly visible traffic signs
RAL 3028	Pure red	Buoys, sufficiently visible traffic signs
RAL 5017	Traffic blue	Traffic signs
RAL 6024	Traffic green	Traffic signs
RAL 6037	Pure green	Buoys, sufficiently visible traffic signs
RAL 6038	Luminous green	Buoys, strongly visible traffic signs
RAL 9016	Traffic white	Traffic signs, buoys
RAL 9017	Traffic black	Traffic signs, buoys

It is recommended that navigation sign surfaces, when they are not a part of the signs themselves, should be RAL 7042 traffic grey A or RAL 7043 traffic grey B.

It may be advisable to use adhesive light-reflective films on markers that are not equipped with lights. For the colours of light-reflective films, reference may be made to the relevant international standards for road transport.




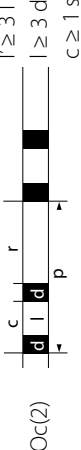
Appendix 4 - Rhythmic lights

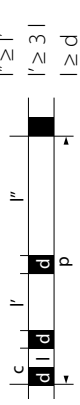
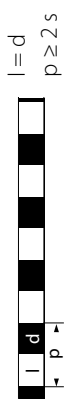


Table 1 - Maximum periods of rhythmic characters of lights



<i>Class</i>	<i>Maximum period, s</i>
Isophase light	12
Single-occulting light	
Single-flashing light	15
Group very quick light	
Group-occulting light of two eclipses	
Long-flashing light	20
Group-flashing light of two flashes	
Group quick light	
Group-occulting light of three or more eclipses	
Group-flashing light of three or more flashes	30
Composite group-flashing light	
Morse Code light	

Note: The periods of rhythmic characters of lights should be selected in accordance with location-specific navigational requirements.

Table 2 - Classification, specifications and application of rhythmic lights

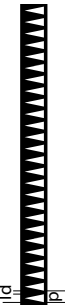


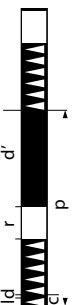
Class	Abbreviation	General description	Specification	Particular use
1 OCCULTING LIGHT		A light in which the total duration of light in a period is longer than the total duration of darkness and the intervals of darkness (eclipses) are usually of equal duration	A light in which the total duration of light in a period is clearly longer than the total duration of darkness and all the eclipses are of equal duration.	
1.1 Single- occulting light	Oc	An occulting light in which an eclipse is regularly repeated	<p>The duration of an appearance of light should not be less than three times the duration of an eclipse.</p> <p>The period should not be less than 2 s.</p>  <p>Example: $l = 3$ s; $d = 1$ s; $p = 4$ s</p>	<p>A single-occulting white light indicates a safe-water mark.</p> <p>A single-occulting yellow light indicates a cross-over mark.</p>
1.2 Group- occulting light	Oc(#), e.g. Oc(2)	An occulting light in which a group of eclipses, specified in number, is regularly repeated	<p>The appearances of light between the eclipses in a group are of equal duration, and this duration is clearly shorter than the duration of the appearance of light between successive groups.</p> <p>The duration of an appearance of light between groups should not be less than three times the duration of an appearance of light within a group.</p> <p>The duration of an appearance of light within a group should not be less than the duration of an eclipse.</p> <p>In a group of two eclipses, the duration of an eclipse together with the duration of an appearance of light within the group should not be less than 1 s.</p> <p>In a group of three or more eclipses, the duration of an eclipse together with the duration of an appearance of light within the group should not be less than 2 s. The number of eclipses in a group should not be greater than four in general, and should be five only as an exception.</p>  <p>Example: $l' = 6$ s; $l = 2$ s; $d = 1$ s; $c = 3$ s; $p = 10$ s</p>	<p>A group-occulting yellow light may indicate:</p> <ul style="list-style-type: none"> • a special mark; • a cross-over mark.

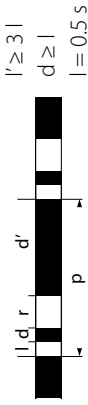



Class	Abbreviation	General description	Specification	Particular use
1.3 Composite group-occluding light	Oc(#+#), e.g. Oc(2+1)	A light similar to a group-occluding light except that successive groups in a period have different numbers of eclipses	<p>This class of light character is not recommended because it is difficult to recognize.</p>  <p>Oc(2+1) $l' \geq l''$ $l' \geq 3 l$ $l \geq d$ $c \geq 1 s$</p> <p>Example: $l' = 9 s; l'' = 3 s; l = 1 s; d = 1 s; c = 2 s; p = 16 s$</p>	An isophase white light may indicate: <ul style="list-style-type: none"> • a safe-water mark; • a bifurcation mark; • a mark outside the fairway indicating obstacles and danger points, if they can be passed on either side; • an advance signal.
2 ISOPHASE LIGHT	ISO	A light in which all the durations of light and darkness are clearly equal	<p>The period should never be less than 2 s, but preferably it should not be less than 4 s in order to reduce the risk of confusion with occulting or flashing lights of similar periods.</p>  <p>$l = d$ $p \geq 2 s$</p> <p>Example: $l = d = 2 s; p = 4 s$</p>	A single-occluding white light indicates a safe-water mark.
3 FLASHING LIGHT		A light in which the total duration of light in a period is shorter than the total duration of darkness and the appearances of light (flashes) are usually of equal duration	<p>A light in which the total duration of light in a period is clearly shorter than the total duration of darkness and all the flashes are of equal duration.</p>	
3.1 Single-flashing light	Fl	A flashing light in which a flash is regularly repeated (at a rate of less than 50 flashes per minute)	<p>The duration of the interval of darkness (eclipse) between two successive flashes should not be less than three times the duration of a flash.</p> <p>The period should not be less than 2 s (or not less than 2.5 s in those countries where a quick rate of 50 flashes per minute is used).</p>  <p>$d \geq 3 l$ $p \geq 2 s$</p> <p>Example: $d = 3 s; l = 1 s; p = 4 s$</p>	<p>A single-flashing red light may indicate:</p> <ul style="list-style-type: none"> • right-hand side of the fairway; • channel near the right bank. <p>A single-flashing green light may indicate:</p> <ul style="list-style-type: none"> • left-hand side of the fairway; • channel near the left bank. <p>A single-flashing yellow light may indicate:</p> <ul style="list-style-type: none"> • a special mark; • a cross-over mark.
3.2 Long-flashing light	LFl	A single-flashing light in which an appearance of light of not less than 2 s duration (long flash) is regularly repeated	 <p>$d \geq 3 l$ $l \geq 2 s$</p> <p>Example: $d = 8 s; l = 2 s; p = 10 s$</p>	A long-flashing white light with a period of 10 s indicates a safe-water mark.

Class	Abbreviation	General description	Specification	Particular use
3.3 Group-flashing light	Fl(#) e.g. Fl(2)	A flashing light in which a group of flashes, specified in number, is regularly repeated	<p>The eclipses between the flashes in a group are of equal duration, and this duration is clearly shorter than the duration of the eclipse between successive groups.</p> <p>The duration of an eclipse between groups should not be less than three times the duration of an eclipse within a group.</p> <p>The duration of an eclipse within a group should not be less than the duration of a flash.</p> <p>In a group of two flashes, the duration of a flash together with the duration of the eclipse within the group should not be less than 1 s.</p> <p>In a group of three or more flashes, the duration of a flash together with the duration of an eclipse within a group should not be less than 2 s (or not less than 2.5 s in those countries where a quick rate of 50 flashes per minute is used).</p> <p>The number of flashes in a group should not be greater than five in general, and should be six only as an exception.</p>  <p style="text-align: center;"> $d' \geq 3d$ $d \geq l$ $c \geq 1 s$ </p> <p>Example: $d' = 6 s; d = 2 s; l = 1 s; c = 3 s; p = 10 s$</p>	<p>A group-flashing white light with a group of two flashes, in a period of 5 s or 10 s, indicates an isolated danger mark.</p> <p>A group-flashing white light with a group of three flashes indicates a bifurcation mark.</p> <p>A group-flashing yellow light with a group of four, five or (exceptionally) six flashes may indicate:</p> <ul style="list-style-type: none"> • a special mark; • a cross-over mark.
3.4 Composite group-flashing light	Fl(#+#) e.g. Fl(2+1)	A flashing light in which a group of flashes, specified in number, is regularly repeated	<p>Light characters should be restricted to (2+1) flashes in general, and should be (3+1) flashes only as an exception.</p>  <p style="text-align: center;"> $d'' \geq d'$ $d' \geq 3 d$ $d \geq l$ $c \geq 1 s$ </p> <p>Example: $d'' = 9 s; d' = 3 s;$ $d = 1 s; l = 1 s; c = 2 s; p = 16 s$</p>	<p>A composite group-flashing yellow light indicates a special mark.</p> <p>A composite group-flashing red or green light with a group of (2 + 1) flashes indicates a modified lateral (preferred-channel) mark.</p>

Class	Abbreviation	General description	Specification	Particular use
4	QUICK LIGHT	A light in which flashes are repeated at a rate of not less than 50 flashes per minute but less than 80 flashes* per minute	A light in which identical flashes are repeated at the rate of 60 flashes per minute.	
4.1	Continuous quick light	A quick light in which a flash is regularly repeated	<p>Example: $l = d = 0.5 \text{ s}; p = 1 \text{ s}$</p>	<p>A continuous quick white light may indicate:</p> <ul style="list-style-type: none"> • a north cardinal mark; • a bifurcation mark; • a mark outside the channel indicating obstacles and danger points, if they can be passed on either side.
4.2	Group quick light	A quick light in which a specified group of flashes is regularly repeated	<p>The number of flashes in a group should be three or nine. An exceptional light character is reserved to indicate a south cardinal mark.</p> <p>Q(3)</p> <p>Example: $d' = 7.5 \text{ s}; l = d = 0.5 \text{ s}; c = 1 \text{ s}; p = 10 \text{ s}$</p> <p>Q(9)</p> <p>Example: $d' = 6.5 \text{ s}; l = d = 0.5 \text{ s}; c = 1 \text{ s}; p = 15 \text{ s}$</p> <p>Q(6) +LF1</p> <p>Example: $d' = 7 \text{ s}; l' = 2 \text{ s}; l = d = 0.5 \text{ s}; c = 1 \text{ s}; p = 15 \text{ s}$</p>	<p>A group quick white light with a group of three flashes, in a period of 10 s, indicates an east cardinal mark.</p> <p>A group quick white light with a group of nine flashes, in a period of 15 s, indicates a west cardinal mark.</p> <p>A group quick white light with a group of six flashes followed by a long flash of not less than 2 s duration, in a period of 15 s, indicates a south cardinal mark.</p>
5.	VERY QUICK LIGHT	A light in which flashes are repeated at a rate of not less than 80 flashes per minute but less than 160 flashes* per minute	A light in which identical flashes are repeated at the rate of 120 flashes per minute. <p>Example: $d' = 7 \text{ s}; l' = 2 \text{ s}; l = d = 0.5 \text{ s}; c = 1 \text{ s}; p = 15 \text{ s}$</p>	

* The competent authorities should choose the rates for all their quick lights and very quick lights: either 60 and 120 flashes per minute or 50 and 100 flashes per minute.

Class	Abbreviation	General description	Specification	Particular use
5.1	Continuous very quick light	A very quick light in which a flash is regularly repeated	 <p> $d \geq l$ $0.5 \text{ s} \leq p \leq 1.6 \text{ s}$ </p> <p>Example: $l = d = 0.25 \text{ s}; p = 0.5 \text{ s}$</p>	A continuous quick scintillating white light indicates a north cardinal mark.
5.2	Group very quick light	A very quick light in which a specified group of flashes is regularly repeated	<p>The number of flashes in a group should be three or nine. An exceptional light character is reserved for use to indicate a south cardinal mark.</p> <p>VQ(3)</p>  <p> $d' > 1.5 \text{ s}$ $d \geq l$ $0.5 \text{ s} \leq c \leq 0.6 \text{ s}$ </p> <p>Example: $d' = 3.75 \text{ s}; l = d = 0.25 \text{ s}; c = 0.5 \text{ s}; p = 5 \text{ s}$</p> <p>VQ(9)</p>  <p> $d' > 1.5 \text{ s}$ $d \geq l$ $0.5 \text{ s} \leq c \leq 0.6 \text{ s}$ </p> <p>Example: $d' = 5.75 \text{ s}; l = d = 0.25 \text{ s}; c = 0.5 \text{ s}; p = 10 \text{ s}$</p> <p>VQ(6) + LF1</p>  <p> $d' \geq 1.5 l'$ $l' \geq 2 \text{ s}$ $d \geq l$ $0.5 \text{ s} \leq c \leq 0.6 \text{ s}$ </p> <p>Example: $d' = 5 \text{ s}; l' = 2 \text{ s}; l = d = 0.25 \text{ s}; c = 0.5 \text{ s}; p = 10 \text{ s}$</p> <p>A light in which identical flashes are repeated at the rate of 240 flashes per minute.</p>	<p>A group very quick white light with a group of six flashes, in a period of 5 s, indicates an east cardinal mark.</p> <p>A group very quick white light with a group of nine flashes, in a period of 10 s, indicates a west cardinal mark.</p> <p>A group very quick white light with a group of six flashes followed by a long flash of not less than 2 s duration, in a period of 10 s, indicates a south cardinal mark.</p>
6	ULTRA QUICK LIGHT	A light in which flashes are repeated at a rate of not less than 160 flashes per minute and not more than 300 flashes per minute		
6.1	Continuous ultra quick light	An ultra quick light in which a flash is regularly repeated		

Class	Abbreviation	General description	Specification	Particular use
7 MORSE CODE LIGHT	Mo(#) e.g. Mo(A)	A light in which appearances of light of two clearly different durations are grouped to represent a character or characters in the Morse Code	Light characters should be restricted to a single letter in the Morse Code in general, and should be two letters only as an exception. The duration of a "dot" should be about 0.5 s, and the duration of a "dash" should not be less than three times the duration of a "dot". Mo(A)  Example: l' = 1.5 s; l = 0.5 s; d = 0.5 s; d' = 4.5 s; p = 7 s	A Morse Code white light with the single character "A" indicates a safe-water mark. A Morse Code yellow light, but not with either of the single characters "A" or "U"; indicates a special mark.
8 FIXED AND FLASHING LIGHT	F+ relevant charac- ter abbrev- iation, e.g. FFI, FIsO	A light in which a low intensity fixed light phase is combined with a flashing phase of higher luminous intensity compliant with preceding classes of rhythmic characters in this table	Implementation of an FFI rhythmic character is shown below. Other combinations may be implemented as necessary.  Example: d = 3 s; l = 1 s; p = 4 s	
9 ALterna- TING LIGHT	Al## e.g. AIWR	A light showing different colours alternately	This class of light character should be used with care, and efforts should be made to ensure that the different colours appear equally visible to an observer. AIWR  Example: l = d = 2 s; p = 4 s	
10 OccULTING ALterna- TING LIGHT	OcAl OcAlBY	A light showing different colours alternately and a light in which the total duration of light in a period is longer than the total duration of darkness and the intervals of darkness (eclipses) are of equal duration	This class of light is particular to the use of New Danger Marking, and efforts should be made to ensure that the different colours appear equally visible to an observer. OcAlBY  Example: l = 1 s; d = 0.5 s; p = 3 s	An occulting alternating blue and yellow light indicates a New Danger mark.



VHF
18

VHF 68

9

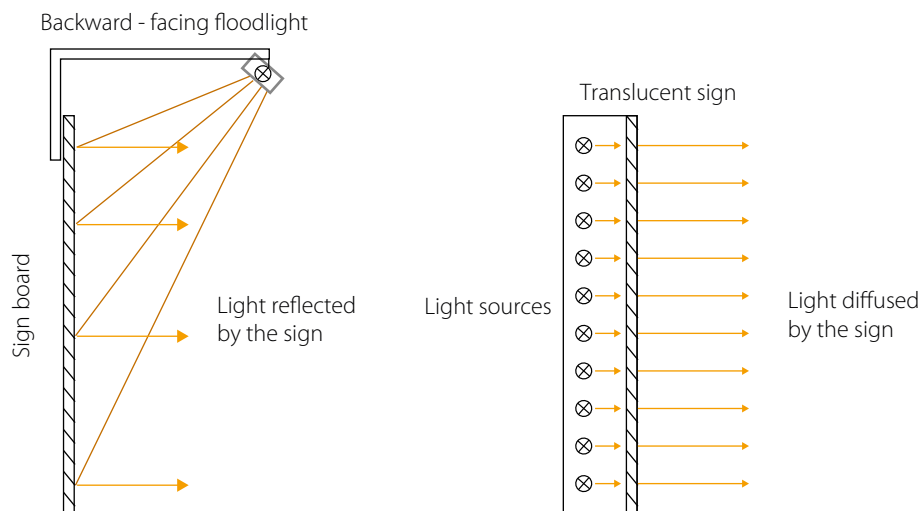
Appendix 5 - Recommendations for the lighting of traffic signs⁴

1. General provisions

The lighting of signs shall be turned on only at night. During daytime, the sign must be identifiable with natural lighting.

The lighting may be arranged either with an external, backward-facing floodlight located in front of the sign or with lighting from the inside of translucent panels (internally backlit signs) as shown in figure 1.

Figure 1

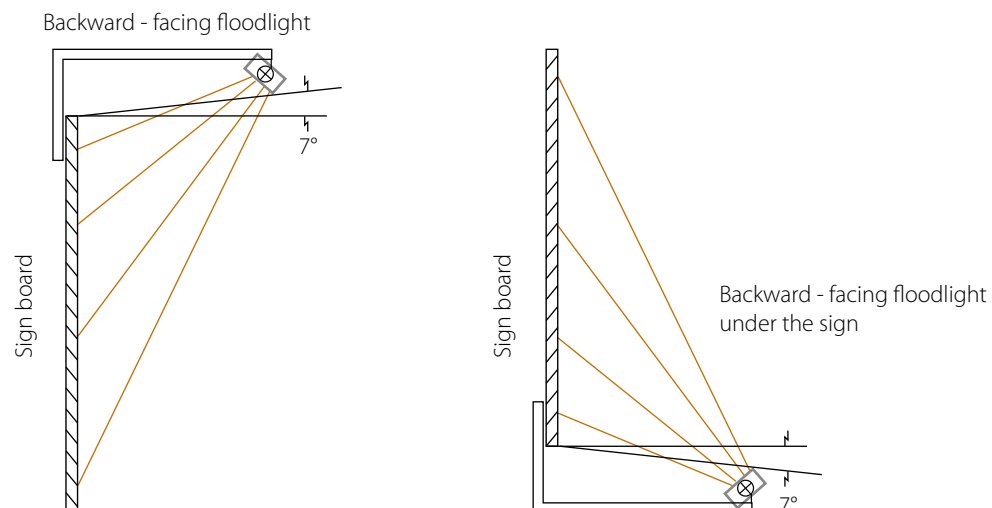


2. External backward-facing lighting of signs

External backward-facing lighting from a floodlight located above the sign is generally arranged with floodlights affixed above or below the sign board. For tall signs it is advisable to affix two floodlights (above and below). For wide signs it is possible to affix several floodlights in a line.

To avoid undesirable dark spots and glare, the floodlights must be located in such a way that they do not block a view from an angle of 7 degrees from the horizontal, drawn from the sign's top or bottom edge.

Figure 2



⁴ This appendix is based on the provisions of European standard EN 12899-1 "Fixed, vertical road traffic signs". Administrations can apply other international or national standards provided that the same safety level is ensured.

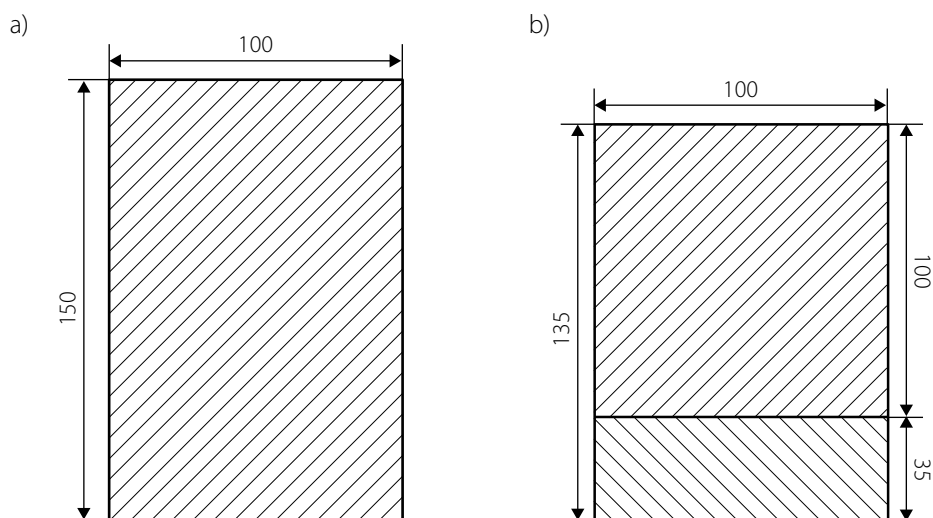
The type of lighting is always determined by the readability of the sign illuminated by the backward-facing light. Minimum dimensions of signs are given in appendix 1 to these Guidelines.

With some boards, the illuminated surface is identical to the board itself. If several boards conveying a single message are installed, for instance with additional text plates, the lighting requirements refer to the overall surface of the combined boards.

The recommended dimensions of the backward-illuminated surface of a sign board are shown in figure 3:

- (a) a single board;
- (b) a board with an additional plate.

Figure 3



As for the backward-illuminated surface, the following lighting parameters are recommended:

- in areas with insignificant background light levels (for example, outside of city limits), the luminosity measured on-site should range from 40 lx to 100 lx,⁵
- in areas with increased background light levels (for example, within city limits), the luminosity measured on-site should range from 100 lx to 400 lx.⁶

The uniformity of lighting is established by the ratio between the minimum luminosity (E_{\min}) and the maximum luminosity (E_{\max}) on the back-illuminated surface. In all cases $E_{\min}:E_{\max} \geq 1:10$.⁷

For the lighting, a white lamp with a colour temperature between 3500 K and 4500 K is used. Care must be taken to ensure that the sign colours are reproduced when the backward-facing light is white.

3. Internally backlit signs

It is recommended to use intensity class L1⁸ for signs in areas with insignificant background light and intensity class L2 for those with increased background light levels.

As for the uniformity of the lighting, the aim should be to reach class U1 (1:10).

⁵ Class E1 of EN 12899.

⁶ Class E2 of EN 12899.

⁷ Class UE1 of EN 12899.

⁸ Intensity and uniformity classes in EN 12899.





Appendix 6 - Examples of variable-message traffic signs⁹

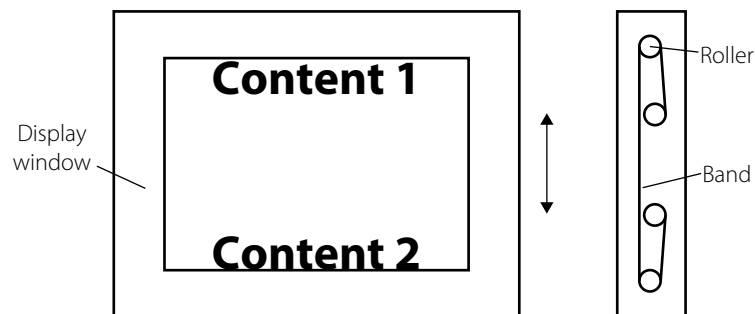
1. Mechanical boards

A. Scrolling sign boards

Boards with a scrolled band of sign images are useful as variable message traffic signs, in particular for displaying the signs in annex 7 to CEVNI.

The sign images are placed on a band that is scrolled vertically on rollers. The rollers place the currently valid image in the window for display.

Figure 1

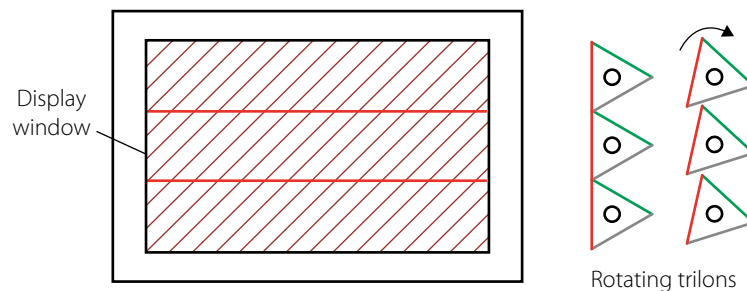


The advantage of scrolling sign boards is that they make it possible to display a large number of signs.

B. Trivision boards

Trivision boards are used preferably to display two different signs from annex 7 to CEVNI. This technique is limited to displaying three distinct sign images. Generally, the third position is reserved as blank, with a grey surface.

Figure 2



In comparison with boards using scrolling bands, the advantage of trilons is that they are mechanically more robust. At the same time, it is not necessary to produce sign images on a flexible surface, which makes it possible to use paints and films of proven value for use on navigation signs.

C. Other mechanical boards

There are many mechanical systems for information boards (for example, including flip-disk boards), with many designed for use in indoor spaces (such as transport terminals or stations). For navigation signs, which generally have to bear the brunt of weather conditions, the service life of such systems is often negligible; they often require servicing.

⁹ This appendix is based on the provisions of European standard EN 12966-1 "Vertical road signs — Variable message signs — Part 1: Product standard". Administrations can apply other international or national standards provided that the same safety level is ensured.

2. Electronic boards

Purely electronic systems for information boards have the basic advantage of incorporating absolutely no moving parts. The ones that are best known are boards using LEDs, liquid crystals or optical fibres. Such messages are displayed as white or yellow digits or letters on a black background. During manufacture, the characters are converted into groups of constituent dots to ensure that they can be read.

While mechanical boards are visible with natural light during daylight hours, electronic boards emit light both day and night. At the same time, a contrasting frame is required, the aim being to reduce the so-called phantom effects caused by sunlight. Reflection angles must be sufficiently large to reliably eliminate reflections on the fairway segments in question. As a direct consequence, electronic boards consume significantly more energy than mechanical ones.

At the same time, in daylight, the boards must be sufficiently luminous so that their messages can be seen even in clear and sunny weather. At night, they must be darkened so as to avoid unwanted brightness or dazzle. Adjustments are made by measuring the background luminous intensity and adapting the intensity of the board accordingly.¹⁰

The boards' reflection angles should also be observed.¹¹

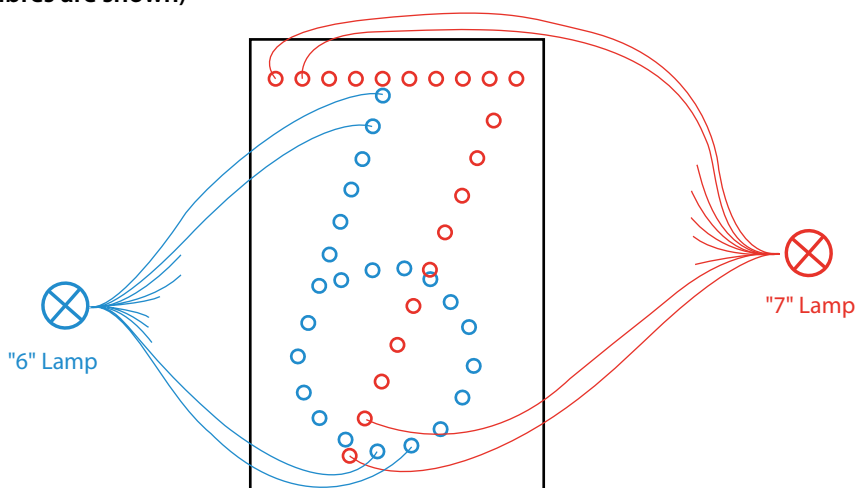
For horizontally illuminated sectors there are classes with ranges up to $\pm 30^\circ$ (60°). Technically, it is possible to display sectors ranging up to $\pm 60^\circ$ (120°) at an acceptable cost.

A. Optical waveguide (optical fibre) boards

Optical fibre boards have been used for many years on variable message road traffic signs (for example, to display temporary speed limits). The sign's image is divided into distinct points of light, with each point backlit by an optical fibre.

When a digit is displayed, the optical fibres of the digit in question are grouped and backlit with a lamp. For each digit there is thus a separate lamp, and each point of light can be used for just one digit. The points thus cannot be individually controlled. Each image must in turn have a source lamp.

Figure 3 - Depiction of light points corresponding with lamps for two digits (for clarity, only some of the optical fibres are shown)



In recent years, optical fibre boards have to a great extent been replaced by LED matrix boards.

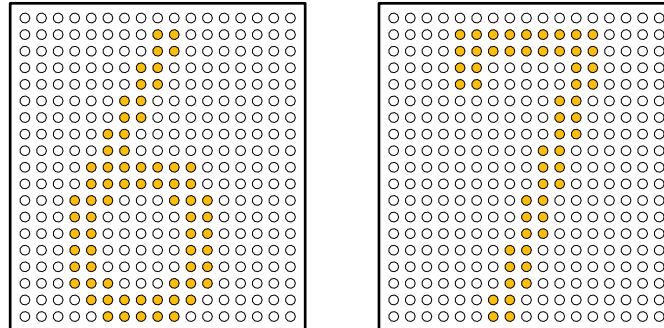
¹⁰ If standard EN 12966-1 is used for this purpose, the adjustment coefficient (the board's maximum-to-minimum luminosity ratio) exceeding 100:1 is applied.

¹¹ The luminance classes described in standard EN 12966-1 are intended for road traffic and would presuppose that the boards are installed at least as high as the minimum height of a bridge allowing for navigation.

B. Light-emitting diode (LED) matrix boards

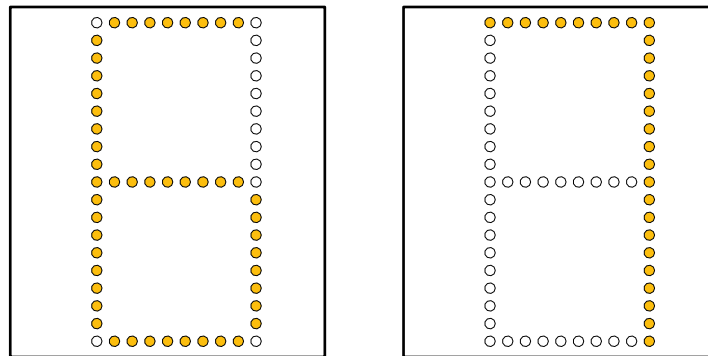
In the case of a LED matrix, each separate point of the image is displayed by a diode that can be independently turned on and off. In principle, such boards can be freely programmed (using a complete matrix), thus making it possible to display any message.

Figure 4 - Board with individually controlled light emitting diodes displaying digits



Often, though, only seven segments required to display digits are connected. As fewer diodes are used, the electronic control is simplified, which results in savings. To reduce costs, it is possible to pre-programme groups of LEDs to display only the messages that are required.

Figure 5 - Board composed of seven segments with separate light emitting diodes



C. Liquid crystal displays (LCDs)

Boards using liquid crystal displays (LCDs) are composed of a regularly illuminated surface placed behind a film of liquid crystals, which blocks areas of the image, thus creating the desired figure. For large boards, monochrome images are preferred, although colour images are possible as well. Diodes have recently been employed to backlight the surface, while fluorescent lamps were previously used.

The advantage of this kind of board is that it produces a very sharp, detailed image, with such high luminosity and contrast that the boards can be used in daylight.

There is a technical disadvantage, though, as the optical characteristics of the liquid crystal film are such that only a small part (less than 25 per cent) of the generated light is displayed. For the same luminosity, boards of this kind require significantly more power than those using LED matrices.

In addition, liquid crystal displays shall be protected against temperature changes and humidity, which involves high costs.

Notes

SIGNI European Code for Signs and Signals on Inland Waterways

The European Code for Signs and Signals on Inland Waterways (SIGNI) provides recommendations for the competent authorities for the installation and application of buoyage and marking on European inland waterways contained in the fifth revision of CEVNI (TRANS/SC.3/115/Rev.5). This new edition of SIGNI is based on revision 2 of Resolution No. 22 and the Guidelines for Waterways Signs and Marking (Resolution No. 59, revision 2).

This edition has been prepared with the participation of River Commissions and the CEVNI Expert Group as well as contributions from the Chairs of the Joint International VTT and Inland ECDIS Expert Group and the International Association of Marine Aids to Navigation and Lighthouse Authorities (IALA).

United Nations Economic Commission for Europe

Palais des Nations
CH - 1211 Geneva 10, Switzerland
Telephone: +41(0)22 917 12 34
E-mail: unece_info@un.org
Website: <http://www.unece.org>

ISBN 978-92-1-117179-2



9 789211 171792