



Economic and Social Council

Distr.

GENERAL

TRANS/WP.29/773
16 February 2001

ENGLISH

Original: ENGLISH
and FRENCH

ECONOMIC COMMISSION FOR EUROPE

INLAND TRANSPORT COMMITTEE

World Forum for Harmonization of Vehicle Regulations (WP.29)

DRAFT REGULATION:

UNIFORM PROVISIONS CONCERNING THE APPROVAL OF MOTOR VEHICLE HEADLAMPS
EMITTING AN ASYMMETRICAL PASSING BEAM OR A DRIVING BEAM
OR BOTH AND EQUIPPED WITH FILAMENT LAMPS

Note: The text reproduced below was adopted by the Administrative Committee (AC.1) of the amended 1958 Agreement at its sixteenth session, following the recommendation by WP.29 at its one-hundred-and-twenty-second session. It is based on document TRANS/WP.29/1998/41, not amended (TRANS/WP.29/743, para. 178). However, the following editorial corrections were introduced by the secretariat: (a) updated footnote 4/ to para. 4.2.1.1.; (b) renumbering of footnotes to paras. 5.3., 5.4., 6.2.2.1., 6.2.2.3., 6.2.3., 6.2.4., 6.2.7. and 8.; (c) corrected reference to para. 6.4.1. in para. 6.4.4.; (d) corrected numbering of items in annex 1; (e) corrected numbering of paragraphs in annex 7, paras. 2 and 3.

A. ADMINISTRATIVE PROVISIONS

0. SCOPE 1/

This Regulation applies to motor vehicle headlamps emitting an asymmetrical passing beam and/or driving beam, which may incorporate lenses of glass or plastic material and which are equipped with replaceable filament lamps.

1. DEFINITIONS

For the purpose of this Regulation,

- 1.1. "Lens" means the outermost component of the headlamp (unit) which transmits light through the illuminating surface;
- 1.2. "Coating" means any product or products applied in one or more layers to the outer face of a lens;
- 1.3. Headlamps of different "types" mean headlamps which differ in such essential respects as:
 - 1.3.1. the trade name or mark;
 - 1.3.2. the characteristics of the optical system;
 - 1.3.3. the inclusion or elimination of components capable of altering the optical effects by reflection, refraction, absorption and/or deformation during operation.
 - 1.3.4. suitability for right-hand or left-hand traffic or for both traffic systems;
 - 1.3.5. the kind of beam produced (passing beam, driving beam or both);
 - 1.3.6. the materials constituting the lenses and coating, if any;
 - 1.3.7. The category of filament lamp used.
- 1.4. Headlamps of different "Classes" (A or B) mean headlamps identified by particular photometric provisions.

2. APPLICATION FOR APPROVAL OF A HEADLAMP

- 2.1. The application for approval shall be submitted by the owner of the trade name or mark or by his duly accredited representative. It shall specify:
 - 2.1.1. whether the headlamp is intended to provide both a passing beam and a driving beam or only one of these beams;
 - 2.1.2. whether, if the headlamp is intended to provide a passing beam, it is designed for both left-hand and right-hand traffic or for either left-hand or right-hand traffic only;

1/ Nothing in this Regulation shall prevent a Party to the Agreement applying this Regulation from prohibiting the combination of a headlamp incorporating a lens of plastic material approved under this Regulation with a mechanical headlamp-cleaning device (with wipers).

- 2.1.3. if the headlamp is equipped with an adjustable reflector, the mounting position(s) of the headlamp in relation to the ground and the longitudinal median plane of the vehicle;
- 2.1.4. whether it concerns a Class A or B headlamp;
- 2.1.5. the category of the filament lamp(s) used, as listed in Regulation No. 37.
- 2.2. Every application for approval shall be accompanied by:
 - 2.2.1. drawings in triplicate in sufficient detail to permit identification of the type and representing a frontal view of the headlamp, with details of lens ribbing if any, and the cross-section; the drawings shall indicate the space reserved for the approval mark;
 - 2.2.1.1. if the headlamp is equipped with an adjustable reflector, an indication of the mounting position(s) of the headlamp in relation to the ground and the longitudinal median plane of the vehicle, if the headlamp is for use in that (those) position(s) only;
 - 2.2.2. a brief technical description;
 - 2.2.3. two samples of the type of headlamp.
 - 2.2.4. For the test of plastic material of which the lenses are made:
 - 2.2.4.1. thirteen lenses;
 - 2.2.4.1.1. six of these lenses may be replaced by six samples of material at least 60 x 80 mm in size, having a flat or convex outer surface and a substantially flat area (radius of curvature not less than 300 mm) in the middle measuring at least 15 x 15 mm;
 - 2.2.4.1.2. every such lens or sample of material shall be produced by the method to be used in mass production;
 - 2.2.4.2. a reflector to which the lenses can be fitted in accordance with the manufacturer's instructions.
 - 2.3. The materials making up the lenses and coatings, if any, shall be accompanied by the test report of the characteristics of these materials and coatings if they have already been tested.
- 3. MARKINGS 2/
 - 3.1. Headlamps submitted for approval shall bear the trade name or mark of the applicant.

2/ In the case of headlamps designed to meet the requirements of traffic moving on one side of the road only (either right or left), it is further recommended that the area which can be occulted to prevent discomfort to users in a country where traffic moves on the side of the road opposite to that of the country for which the headlamp was designed should be outlined indelibly on the front lens. This marking is not necessary, however, where the area is clearly apparent from the design.

- 3.2. They shall comprise, on the lens and on the main body, 3/ spaces of sufficient size for the approval mark and the additional symbols referred to in paragraph 4; these spaces shall be indicated on the drawings referred to in paragraph 2.2.1. above.
- 3.3. Headlamps designed to satisfy the requirements both of right-hand and of left-hand traffic shall bear markings indicating the two settings of the optical unit on the vehicle or of the filament lamp on the reflector; these markings shall consist of the letters "R/D" for the position for right-hand traffic and the letters "L/G" for the position for left-hand traffic.
4. APPROVAL
- 4.1. General
- 4.1.1. If all the samples of a type of headlamp submitted pursuant to paragraph 2 above satisfy the provisions of this Regulation, approval shall be granted.
- 4.1.2. Where grouped, combined or reciprocally incorporated lamps satisfy the requirements of more than one Regulation, a single international approval mark may be affixed provided that each of the grouped, combined or reciprocally incorporated lamps satisfies the provisions applicable to it.
- 4.1.3. An approval number shall be assigned to each type approved. Its first two digits (at present 00) shall indicate the series of amendments incorporating the most recent major technical amendments made to the Regulation at the time of issue of the approval. The same Contracting Party may not assign the same number to another type of headlamp covered by this Regulation.
- 4.1.4. Notice of approval or of extension or refusal or withdrawal of approval or production definitely discontinued of a type of headlamp pursuant to this Regulation shall be communicated to the Parties to the 1958 Agreement applying this Regulation, by means of a form conforming to the model in annex 1 to this Regulation, with the indications according to paragraph 2.2.1.1.
- 4.1.4.1. if the headlamp is equipped with an adjustable reflector and if this headlamp is to be used only in mounting positions according to the indications in paragraph 2.2.1.1. the applicant shall be obliged by approval to inform the user in a proper way about the correct mounting position(s).
- 4.1.5. In addition to the mark prescribed in paragraph 3.1., an approval mark as described in paragraphs 4.2. and 4.3. below shall be affixed in the spaces referred to in paragraph 3.2. above to every headlamp conforming to a type approved under this Regulation.
- 4.2. Composition of the approval mark

3/ If the lens cannot be detached from the main body of the headlamp, a space on the lens shall be sufficient.

The approval mark shall consist of:

- 4.2.1. An international approval marking, comprising:
 - 4.2.1.1. a circle surrounding the letter "E" followed by the distinguishing number of the country which has granted approval; 4/
 - 4.2.1.2. the approval number prescribed in paragraph 4.1.3. above;
- 4.2.2. the following additional symbol (or symbols):
 - 4.2.2.1. on headlamps meeting left-hand traffic requirements only, a horizontal arrow pointing to the right of an observer facing the headlamp, i.e. to the side of the road on which the traffic moves;
 - 4.2.2.2. on headlamps designed to meet the requirements of both traffic systems by means of an appropriate adjustment of the setting of the optical unit or the filament lamp, a horizontal arrow with a head on each end, the heads pointing respectively to the left and to the right;
 - 4.2.2.3. on headlamps meeting the requirements of this Regulation in respect of the passing beam only, the letters "C" for Class A headlamp or "HC" for Class B headlamp;
 - 4.2.2.4. on headlamps meeting the requirements of this Regulation in respect of the driving beam only, the letters "R" for Class A headlamp or "HR" for Class B headlamp;
 - 4.2.2.5. on headlamps meeting the requirements of this Regulation in respect of both the passing beam and the driving beam, the letters "CR" for Class A headlamp or "HCR" for Class B headlamp;
 - 4.2.2.6. on headlamps incorporating a lens of plastic material, the group of letters "PL" to be affixed near the symbols prescribed in paragraphs 4.2.2.3. to 4.2.2.5. above;

4/ 1 for Germany, 2 for France, 3 for Italy, 4 for the Netherlands, 5 for Sweden, 6 for Belgium, 7 for Hungary, 8 for the Czech Republic, 9 for Spain, 10 for Yugoslavia, 11 for the United Kingdom, 12 for Austria, 13 for Luxembourg, 14 for Switzerland, 15 (vacant), 16 for Norway, 17 for Finland, 18 for Denmark, 19 for Romania, 20 for Poland, 21 for Portugal, 22 for the Russian Federation, 23 for Greece, 24 for Ireland, 25 for Croatia, 26 for Slovenia, 27 for Slovakia, 28 for Belarus, 29 for Estonia, 30 (vacant), 31 for Bosnia and Herzegovina, 32 for Latvia, 33 (vacant), 34 for Bulgaria, 35-36 (vacant), 37 for Turkey, 38-39 (vacant), 40 for The former Yugoslav Republic of Macedonia, 41 (vacant), 42 for the European Community (Approvals are granted by its Member States using their respective ECE symbol), 43 for Japan, 44 (vacant), 45 for Australia and 46 for Ukraine. Subsequent numbers shall be assigned to other countries in the chronological order in which they ratify or accede to the Agreement Concerning the Adoption of Uniform Technical Prescriptions for Wheeled Vehicles, Equipment and Parts which can be Fitted and/or be Used on Wheeled Vehicles and the Conditions for Reciprocal Recognition of Approvals Granted on the Basis of these Prescriptions, and the numbers thus assigned shall be communicated by the Secretary-General of the United Nations to the Contracting Parties to the Agreement.

- 4.2.2.7. on headlamps meeting the requirements of this Regulation in respect of the driving beam, an indication of the maximum luminous intensity expressed by a reference mark, as defined in paragraph 6.3.2.1.2. below, placed near the circle surrounding the letter "E";

In the case of reciprocally incorporated headlamps, indication of the maximum luminous intensity of the driving beams as a whole shall be expressed as above.

- 4.2.3. In every case the relevant operating mode used during the test procedure according to paragraph 1.1.1.1. of annex 4 and the permitted voltage(s) according to paragraph 1.1.1.2. of annex 4 shall be stipulated on the approval forms and on the communication forms transmitted to the countries which are Contracting Parties to the Agreement and which apply this Regulation.

In the corresponding cases the device shall be marked as follows:

- 4.2.3.1. on headlamps meeting the requirements of this Regulation which are so designed that the filament of the passing beam shall not be lit simultaneously with that of any other lighting function with which it may be reciprocally incorporated: an oblique stroke (/) shall be placed behind the passing lamp symbol in the approval mark.

- 4.2.3.2. on headlamps meeting the requirements of annex 4 to this Regulation only when supplied with a voltage of 6 V or 12 V, a symbol consisting of the number 24 crossed out by an oblique cross (x), shall be placed near the filament lamp holder.

- 4.2.4. The two digits of the approval number (at present 00) which indicate the series of amendments incorporating the most recent major technical amendments made to the Regulation at the time of issue of the approval and, if necessary, the required arrow may be marked close to the above additional symbols.

- 4.2.5. The marks and symbols referred to in paragraphs 4.2.1. and 4.2.2. above shall be clearly legible and be indelible even when the headlamp is fitted in the vehicle.

4.3. Arrangement of the approval mark

4.3.1. Independent lamps

Annex 2, figures 1 to 9, to this Regulation gives examples of arrangements of the approval mark with the above-mentioned additional symbols.

4.3.2. Grouped, combined or reciprocally incorporated lamps

- 4.3.2.1. Where grouped, combined or reciprocally incorporated lamps have been found to comply with the requirements of several Regulations, a single international approval mark may be affixed, consisting of a circle surrounding the letter "E" followed by the distinguishing number of the country which has granted the approval, and an approval number. This approval mark may be located anywhere on the grouped, combined or reciprocally incorporated lamps, provided that:

- 4.3.2.1.1. it is visible after their installation;
- 4.3.2.1.2. no part of the grouped, combined or reciprocally incorporated lamps that transmits light can be removed without at the same time removing the approval mark.
- 4.3.2.2. The identification symbol for each lamp appropriate to each Regulation under which approval has been granted, together with the corresponding series of amendments incorporating the most recent major technical amendments to the Regulation at the time of issue of the approval, and if necessary, the required arrow shall be marked:
- 4.3.2.2.1. either on the appropriate light-emitting surface,
- 4.3.2.2.2. or in a group, in such a way that each of the grouped, combined or reciprocally incorporated lamps may be clearly identified (see four possible examples in annex 2).
- 4.3.2.3. The size of the components of a single approval mark shall not be less than the minimum size required for the smallest of the individual marks by the Regulation under which approval has been granted.
- 4.3.2.4. An approval number shall be assigned to each type approved. The same Contracting Party may not assign the same number to another type of grouped, combined or reciprocally incorporated lamps covered by this Regulation.
- 4.3.2.5. Annex 2, figure 10, to this Regulation gives examples of arrangements of approval marks for grouped, combined or reciprocally incorporated lamps with all the above-mentioned additional symbols.
- 4.3.3. Lamps, the lens of which are used for different types of headlamps and which may be reciprocally incorporated or grouped with other lamps
- The provisions laid down in paragraph 4.3.2. above are applicable.
- 4.3.3.1. In addition, where the same lens is used, the latter may bear the different approval marks relating to the different types of headlamps or units of lamps, provided that the main body of the headlamp, even if it cannot be separated from the lens, also comprises the space described in paragraph 3.2. above and bears the approval marks of the actual functions.
- If different types of headlamps comprise the same main body, the latter may bear the different approval marks.
- 4.3.3.2. Annex 2, figure 11, to this Regulation gives examples of arrangements of approval marks relating to the above case.
- B. TECHNICAL REQUIREMENTS FOR HEADLAMPS 5/**
5. GENERAL SPECIFICATIONS

5/ Technical requirements for filament lamps: see Regulation No. 37.

- 5.1. Each sample shall conform to the specifications set forth in paragraphs 6 to 8 below.
- 5.2. Headlamps shall be so made as to retain their prescribed photometric characteristics and to remain in good working order when in normal use, in spite of the vibrations to which they may be subjected.
- 5.2.1. Headlamps shall be fitted with a device enabling them to be so adjusted on the vehicles as to comply with the rules applicable to them. Such a device need not be fitted on units in which the reflector and the diffusing lens cannot be separated, provided the use of such units is confined to vehicles on which the headlamp setting can be adjusted by other means.
- Where a headlamp providing a passing beam and a headlamp providing a driving beam, each equipped with its own filament lamp, are assembled to form a composite unit the adjusting device shall enable each optical system individually to be duly adjusted.
- 5.2.2. However, these provisions shall not apply to headlamp assemblies whose reflectors are indivisible. For this type of assembly the requirements of paragraph 6.3. of this Regulation apply.
- 5.3. The headlamp shall be equipped with filament lamp(s) approved according to Regulation No. 37. Any Regulation No. 37 filament lamp may be used, provided that no restriction on the application is made in the table of contents of Regulation No. 37. 6/
- 5.4. The components by which a filament lamp is fixed to the reflector shall be so made that, even in darkness, the filament lamp can be fixed in no position but the correct one. 7/
- 5.5. The filament lamp holder shall conform to the characteristics given in IEC Publication 61-2, third edition, 1969. The holder data sheet relevant to the category of filament lamp used, applies.
- 5.6. Headlamps designed to satisfy the requirements both of right-hand and of left-hand traffic may be adapted for traffic on a given side of the road either by an appropriate initial setting when fitted on the vehicle or by selective setting by

6/ HIR1 and/or H9 filament lamps shall only be permitted to produce passing beam in conjunction with the installation of headlamp cleaning device(s) conforming to Regulation No. 45. In addition, with respect to vertical inclination, the provision of paragraph 6.2.6.2.2. of Regulation No. 48, 01 series of amendments, shall be applied when these lamps are installed.

This restriction shall apply as long as there is no general agreement on the use of levelling devices and headlamp cleaners with respect to the level of the performance of the headlamp.

7/ A headlamp is regarded as satisfying the requirements of this paragraph if the filament lamp can be easily fitted into the headlamp and the positioning lugs can be correctly fitted into their slots even in darkness.

the user. Such initial or selective setting may consist, for example, of fixing either the optical unit at a given angle on the vehicle or the filament lamp at a given angle in relation to the optical unit. In all cases, only two different and clearly distinct settings, one for right-hand and one for left-hand traffic, shall be possible, and the design shall preclude inadvertent shifting from one setting to the other or setting in an intermediate position. Where two different setting positions are provided for the filament lamp, the components for attaching the filament lamp to the reflector must be so designed and made that, in each of its two settings, the filament lamp will be held in position with the precision required for headlamps designed for traffic on only one side of the road. Conformity with the requirements of this paragraph shall be verified by visual inspection and, where necessary, by a test fitting.

- 5.7. Complementary tests shall be done according to the requirements of annex 4 to ensure that in use there is no excessive change in photometric performance.
- 5.8. If the lens of the headlamp is of plastic material, tests shall be done according to the requirements of annex 6.
- 5.9. On headlamps designed to provide alternately a driving beam and a passing beam, any mechanical, electromechanical or other device incorporated in the headlamp for switching from one beam to the other shall be so constructed that:
 - 5.9.1. the device is strong enough to withstand 50,000 operations without suffering damage despite the vibrations to which it may be subjected in normal use;
 - 5.9.2. in the case of failure it shall automatically obtain the passing beam position;
 - 5.9.3. either the passing beam or the driving beam shall always be obtained without any possibility of the mechanism stopping in between two positions;
 - 5.9.4. the user cannot, with ordinary tools, change the shape or position of the moving parts.

6. ILLUMINATION

6.1. General provisions

- 6.1.1. Headlamps shall be so made that they give adequate illumination without dazzle when emitting the passing beam, and good illumination when emitting the driving beam.
- 6.1.2. The illumination produced by the headlamp shall be determined by means of a vertical screen set up 25 m forward of the

headlamp and at right angles to its axes as shown in annex 3 to this Regulation.

- 6.1.3. The headlamps shall be checked by means of an uncoloured standard (étalon) filament lamp designed for a rated voltage of 12 V. During the checking of the headlamp, the voltage at the terminals of the filament lamp shall be regulated so as to obtain the reference luminous flux as indicated at the relevant data sheet of Regulation No. 37.
- 6.1.4. The headlamp shall be considered acceptable if it meets the requirements of this paragraph 6 with at least one standard (étalon) filament lamp, which may be submitted with the headlamp.
- 6.2. Provisions concerning passing beams
- 6.2.1. The passing beam must produce a sufficiently sharp "cut-off" to permit a satisfactory adjustment with its aid. The "cut-off" must be a horizontal straight line on the side opposite to the direction of the traffic for which the headlamp is intended; on the other side, it must not extend beyond either the broken line HV H₁ H₄ formed by a straight line HV H₁ making a 45° angle with the horizontal and the straight line H₁ H₄, 25 cm above the straight line hh, or the straight line HV H₃, inclined at an angle of 15° above the horizontal (see annex 3). A cut-off extending beyond both line HV H₂ and line H₂ H₄ and resulting from a combination of the two above possibilities shall in no circumstances be permitted.
- 6.2.2. The headlamp shall be so aimed that:
- 6.2.2.1. in the case of headlamps designed to meet the requirements of right-hand traffic, the "cut-off" on the left-half of the screen 8/ is horizontal and, in the case of headlamps designed to meet the requirements of left-hand traffic, the "cut-off" on the right-half of the screen is horizontal;
- 6.2.2.2. this horizontal part of the "cut-off" is situated on the screen 25 cm below the level hh (see annex 3);
- 6.2.2.3. the "elbow" of the "cut-off" is on line vv. 9/
- 6.2.3. When so aimed, the headlamp need, if its approval is sought solely for provision of a passing beam, 10/ comply only with the requirements set out in paragraphs 6.2.5. to 6.2.7. below; if it is intended to provide both a passing beam and a driving beam, it shall comply with the requirements set out in paragraphs 6.2.5. to 6.2.7. and 6.3.

8/ The test screen must be sufficiently wide to allow examination of the "cut-off" over a range of at least 5° on either side of the line vv.

9/ If the beam does not have a cut-off with a clear "elbow", the lateral adjustment shall be effected in the manner which best satisfies the requirements for illumination at points 75 R and 50 R for right-hand traffic and for points 75 L and 50 L for left-hand traffic.

10/ Such a special "passing beam" headlamp may incorporate a driving beam not subject to requirements.

- 6.2.4. Where a headlamp so aimed does not meet the requirements set out in paragraphs 6.2.5. to 6.2.7. and 6.3., its alignment may be changed, provided that the axis of the beam is not displaced laterally by more than 1° (= 44 cm) to the right or left. 11/ To facilitate alignment by means of the "cut-off", the headlamp may be partially occulted in order to sharpen the "cut-off".
- 6.2.5. The illumination produced on the screen by the passing beam shall meet the following requirements:

| Point on measuring screen | | Required illumination in lux | |
|--|---------------------------------|------------------------------|------------------|
| Headlamps for right-hand traffic | Headlamps for left-hand traffic | Class A headlamp | Class B headlamp |
| Point B 50 L | Point B 50 R | ≤ 0.4 | ≤ 0.4 |
| Point 75 R | Point 75 L | ≥ 6 | ≥ 12 |
| Point 75 L | Point 75 R | ≤ 12 | ≤ 12 |
| Point 50 L | Point 50 R | ≤ 15 | ≤ 15 |
| Point 50 R | Point 50 L | ≥ 6 | ≥ 12 |
| Point 50 V | Point 50 V | - | ≥ 6 |
| Point 25 L | Point 25 R | ≥ 1.5 | ≥ 2 |
| Point 25 R | Point 25 L | ≥ 1.5 | ≥ 2 |
| Any point in zone III | | ≤ 0.7 | ≤ 0.7 |
| Any point in zone IV | | ≥ 2 | ≥ 3 |
| Any point in zone I | | ≤ 20 | ≤ 2E <u>*</u> / |
| <u>*</u> / E is the actually measured value in points 50R respectively 50L | | | |

- 6.2.6. There shall be no lateral variations detrimental to good visibility in any of the zones I, II, III and IV.
- 6.2.7. The illumination values in zones "A" and "B" as shown in figure C in annex 3 shall be checked by the measurement of the photometric values of points 1 to 8 on this figure; these values shall lie within the following limits: 12/

$$1 + 2 + 3 \geq 0.3 \text{ lux, and}$$

$$4 + 5 + 6 \geq 0.6 \text{ lux, and}$$

$$0.7 \text{ lux} \geq 7 \geq 0.1 \text{ lux and}$$

$$0.7 \text{ lux} \geq 8 \geq 0.2 \text{ lux}$$

11/ The limit of realignment of 1° towards the right or left is not incompatible with upward or downward vertical realignment. The latter is limited only by the requirements of paragraph 6.3. However, the horizontal part of the "cut-off" should not extend beyond the line hh (the provisions of paragraph 6.3. are not applicable to headlamps intended to meet the requirements of this Regulation only for provision of a passing beam).

12/ Illumination values in any point of zones A and B, which also lies within zone III, shall not exceed 0.7 lux.

6.2.8. Headlamps designed to meet the requirements of both right-hand and left-hand traffic must, in each of the two setting positions of the optical unit or of the filament lamp, meet the requirements set forth above for the corresponding direction of traffic.

6.3. Provisions concerning driving beams

6.3.1. In the case of a headlamp designed to provide a driving beam and a passing beam, measurements of the illumination produced on the screen by the driving beam shall be taken with the same headlamp alignment as for measurements under paragraphs 6.2.5. to 6.2.7. above; in the case of a headlamp providing a driving beam only, it shall be so adjusted that the area of maximum illumination is centred on the point of intersection of lines hh and vv; such a headlamp need meet only the requirements referred to in paragraph 6.3. Where more than one light source is used to provide the driving beam, the combined functions shall be used to determine the maximum value of the illumination (E_M).

6.3.2. The illumination produced on the screen by the driving beam shall meet the following requirements.

6.3.2.1. The point of intersection (HV) of lines hh and vv shall be situated within the isolux 80 per cent of maximum illumination. This maximum value (E_M) shall not be less than 32 lux for Class A headlamps and 48 lux for Class B headlamps. The maximum value shall in no circumstances exceed 240 lux; in addition, in the case of a combined passing and driving headlamp, this maximum value shall not be more than 16 times the illumination measured for the passing beam at point 75 R (or 75 L).

6.3.2.1.1. The maximum intensity (I_M) of the driving beam expressed in thousands of candelas shall be calculated by the formula:

$$I_M = 0.625 E_M$$

6.3.2.1.2. The reference mark (I'_M) of this maximum intensity, referred to in paragraph 4.2.2.7. above, shall be obtained by the ratio:

$$I'_M = \frac{I_M}{3} = 0.208 E_M$$

This value shall be rounded off to the value 7.5 - 10 - 12.5 - 17.5 - 20 - 25 - 27.5 - 30 - 37.5 - 40 - 45 - 50.

6.3.2.2. Starting from point HV, horizontally to the right and left, the illumination shall be not less than 16 lux for Class A headlamp and 24 lux for Class B headlamp up to a distance of 1.125 m and not less than 4 lux for Class A headlamp and 6 lux for Class B headlamp up to a distance of 2.25 m.

6.4. In the case of headlamps with adjustable reflector the requirements of paragraphs 6.2. and 6.3. are applicable for each mounting position indicated according to paragraph 2.1.3. For verification the following procedure shall be used:

6.4.1. Each applied position is realized on the test goniometer with respect to a line joining the centre of the light source and point HV on a aiming screen. The adjustable reflector is then moved into such a position that the light pattern on the screen

corresponds to the aiming prescriptions of paragraphs 6.2.1. to 6.2.2.3. and/or 6.3.1;

- 6.4.2. with the reflector initially fixed according to paragraph 6.4.1., the headlamp must meet the relevant photometric requirements of paragraphs 6.2. and 6.3;
- 6.4.3. additional tests are made after the reflector has been moved vertically $\pm 2^\circ$ or at least into the maximum position, if less than 2° , from its initial position by means of the headlamps adjusting device. Having re-aimed the headlamp as a whole (by means of the goniometer for example) in the corresponding opposite direction the light output in the following directions shall be controlled and lie within the required limits:
- passing beam: points HV and 75 R (75 L respectively);
driving beam: I_M and point HV (percentage of I_M).
- 6.4.4. if the applicant has not indicated more than one mounting position, the procedure of paragraphs 6.4.1. to 6.4.3. shall be repeated for all other positions;
- 6.4.5. if the applicant has not asked for special mounting positions, the headlamp shall be aimed for measurements of paragraphs 6.2. and 6.3. with the headlamps adjusting device in its mean position. The additional test of paragraph 6.4.3. shall be made with the reflector moved into its extreme positions (instead of $\pm 2^\circ$) by means of the headlamps adjusting device.
- 6.5. The screen illumination values mentioned in paragraphs 6.2.5. to 6.2.7. and 6.3. above shall be measured by means of a photoreceptor, the effective area of which shall be contained within a square of 65 mm side.

7. COLOUR

- 7.1 The colour of the light emitted shall be white. Expressed in CIE trichromatic coordinates, the light of the beams shall be in the following boundaries:

| | |
|----------------------|--------------------------|
| limit towards blue | $x \geq 0.310$ |
| limit towards yellow | $x \leq 0.500$ |
| limit towards green | $y \leq 0.150 + 0.640 x$ |
| limit towards green | $y \leq 0.440$ |
| limit towards purple | $y \geq 0.050 + 0.750 x$ |
| limit towards red | $y \geq 0.382$ |

8. GAUGING OF DISCOMFORT

The discomfort caused by the passing beam of headlamps shall be gauged. 13/

C. FURTHER ADMINISTRATIVE PROVISIONS

9. MODIFICATION OF THE HEADLAMP TYPE AND EXTENSION OF APPROVAL
- 9.1. Every modification of the headlamp type shall be notified to the administrative department which approved the headlamp type. The said department may then either:
- 9.1.1. Consider that the modifications made are unlikely to have appreciable adverse effects and that in any event the headlamp still complies with the requirements; or
- 9.1.2. Require a further test report from the technical service responsible for conducting the tests.
- 9.2. Confirmation or refusal of approval, specifying the alterations, shall be communicated by the procedure specified in paragraph 4.1.4. above to the Parties to the Agreement which apply this Regulation.
- 9.3. The competent authority issuing the extension of approval shall assign a series number to each communication form drawn up for such an extension and inform thereof the other Parties to the 1958 Agreement applying this Regulation by means of a communication form conforming to the model in annex 1 to this Regulation.
10. CONFORMITY OF PRODUCTION
- The conformity of production procedures shall comply with those set out in the Agreement, Appendix 2 (E/ECE/324-E/ECE/TRANS/505/Rev.2) with the following requirements:
- 10.1. Headlamps approved under this Regulation shall be so manufactured as to conform to the type approved by meeting the requirements set forth in paragraphs 6 and 7.
- 10.2. the minimum requirements for conformity of production control procedures set fourth in annex 5 to this Regulation shall be complied with.
- 10.3. The minimum requirements for sampling by an inspector set forth in annex 7 to this Regulation shall be complied with.
- 10.4. The authority which has granted type approval may at any time verify the conformity control methods applied in each production facility. The normal frequency of these verifications shall be once every two years.
- 10.5. Headlamps with apparent defects are disregarded.
- 10.6. The reference mark is disregarded.
11. PENALTIES FOR NON-CONFORMITY OF PRODUCTION
- 11.1. The approval granted in respect of a type of headlamp pursuant to this Regulation may be withdrawn if the requirements are not complied with or if a headlamp bearing the approval mark does not conform to the type approved.

- 11.2. If a Contracting Party to the Agreement applying this Regulation withdraws an approval it has previously granted, it shall forthwith so notify the other Contracting Parties applying this Regulation by means of a communication form conforming to the model in annex 1 to this Regulation.
12. PRODUCTION DEFINITELY DISCONTINUED
- If the holder of the approval completely ceases to manufacture a type of headlamp approved in accordance with this Regulation, he shall so inform the authority which granted the approval. Upon receiving the relevant communication, that authority shall inform thereof the other Parties to the 1958 Agreement applying this Regulation by means of a communication form conforming to the model in annex 1 to this Regulation.
13. NAMES AND ADDRESSES OF TECHNICAL SERVICES RESPONSIBLE FOR CONDUCTING APPROVAL TESTS, AND OF ADMINISTRATIVE DEPARTMENTS
- The Parties to the 1958 Agreement applying this Regulation shall communicate to the United Nations Secretariat the names and addresses of the technical services responsible for conducting approval tests and of the administrative departments which grant approval and to which forms certifying approval or extension or refusal or withdrawal of approval, or production definitely discontinued, issued in other countries, are to be sent.
-

Annex 1

COMMUNICATION

(maximum format: A4 (210 x 297 mm))

issued by: Name of administration:
.....
.....
.....



concerning: 2/ APPROVAL GRANTED
APPROVAL EXTENDED
APPROVAL REFUSED
APPROVAL WITHDRAWN
PRODUCTION DEFINITELY DISCONTINUED

of a type of headlamp pursuant to Regulation No.

Approval No. ...

Extension No.

1. Trade name or mark of the device:
2. Manufacturer's name for the type of device:
3. Manufacturer's name and address:
4. If applicable, name and address of manufacturer's representative:
.
5. Submitted for approval on:
6. Technical service responsible for conducting approval tests:
.
7. Date of report issued by that service:
8. Number of report issued by that service:
9. Brief description:
Category as described by the relevant marking: 3/
Number and category(ies) of filament lamp(s):
10. Approval mark position:
11. Reason(s) for extension of approval:
12. Approval granted/extended/refused//withdrawn 2/
13. Place:
14. Date:
15. Signature:

Annex 2

EXAMPLES OF ARRANGEMENT OF APPROVAL MARKS

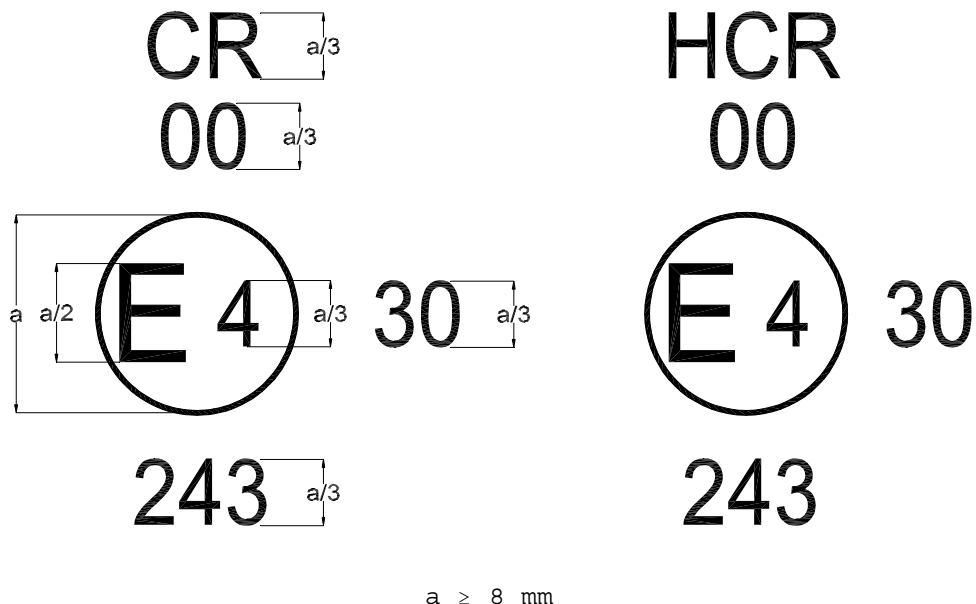

Figure 1

Figure 2

The headlamp bearing one of the above approval marks has been approved in the Netherlands (E 4) pursuant to Regulation No. XXX under approval number 243, meeting the requirements of this Regulation in its original form (00). The passing beam is designed for right-hand traffic only. The letters CR (Figure 1) indicate that it concerns a Class A passing and driving beam and the letters HCR (Figure 2) indicate that it concerns a Class B passing and driving beam.

The figure 30 indicates that the maximum luminous intensity of the driving beam is between 86250 and 101250 candelas.

Note: The approval number and additional symbols shall be placed close to the circle and either above or below the letter 'E', or to the right or left of that letter. The digits of the approval number shall be on the same side of the letter 'E' and face in the same direction.

The use of Roman numerals as approval numbers should be avoided so as to prevent any confusion with other symbols.

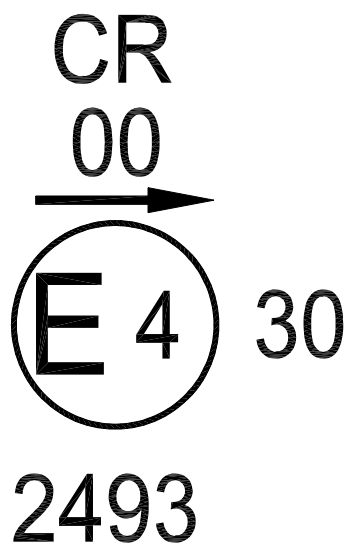

Figure 3

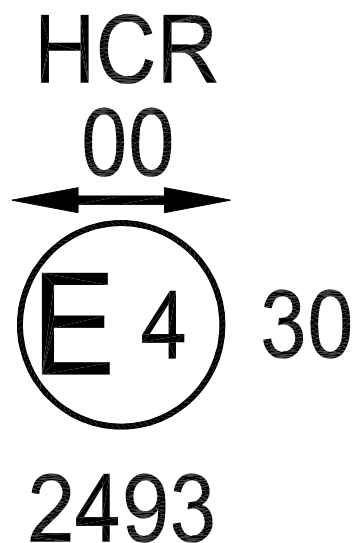

Figure 4a

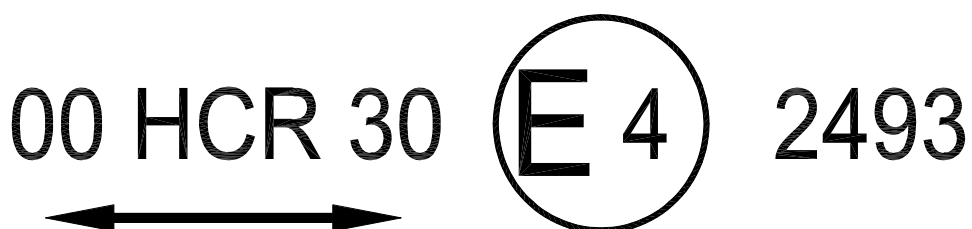
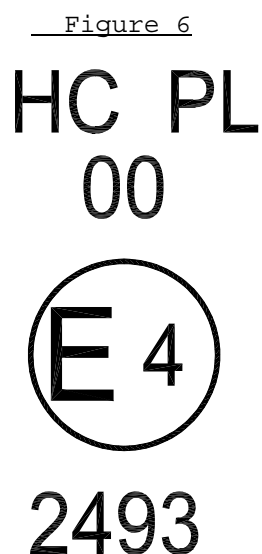
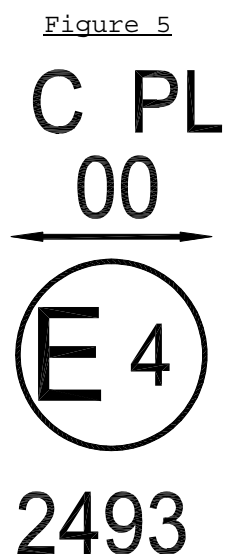

Figure 4b

The headlamp bearing the above approval mark meets the requirements of this Regulation in respect of both the passing beam and the driving beam and is designed:

Figure 3: Class A for left hand traffic only.

Figures 4a and 4b: Class B for both traffic systems by means of an appropriate adjustment of the setting of the optical unit or the filament lamp on the vehicle.



The headlamp bearing the above approval mark is a headlamp incorporating a lens of plastic material meeting the requirements of this Regulation in respect of the passing beam only and is designed:

Figure 5: Class A for both traffic systems.

Figure 6: Class B for right-hand traffic only.

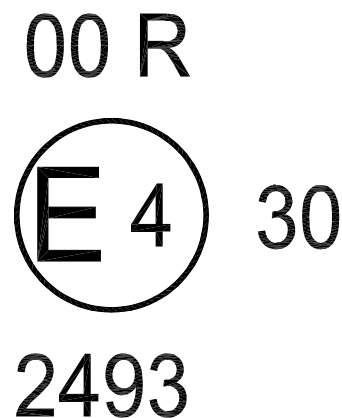
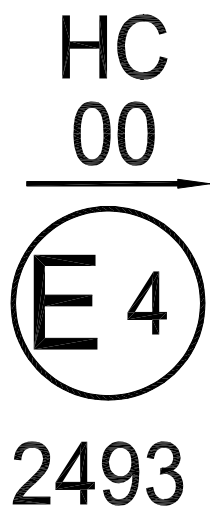

Figure 7

Figure 8

The headlamp bearing the above approval mark is a headlamp meeting the requirements of this Regulation:

Figure 7: Class B in respect of the passing beam only and is designed for left-hand traffic only.

Figure 8: Class A in respect of the driving beam only.

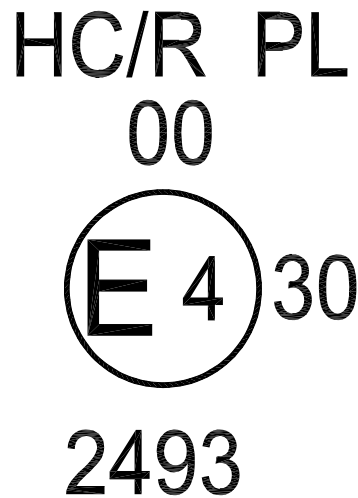

Figure 9

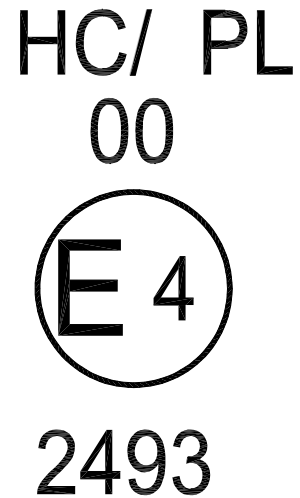

Figure 10

Identification of a headlamp incorporating a lens of plastic material meeting the requirements of this Regulation:

Figure 9: Class B in respect to both the passing beam and driving beam and designed for right-hand traffic only.

Figure 10: Class B in respect to the passing beam only and designed for right-hand traffic only.

The passing beam shall not be operate simultaneously with the driving beam and/or another reciprocally incorporated headlamp.

Simplified marking for grouped, combined or reciprocally incorporated lamps

Figure 11

(The vertical and horizontal lines schematize the shape of the light-signalling device. They are not part of the approval mark).

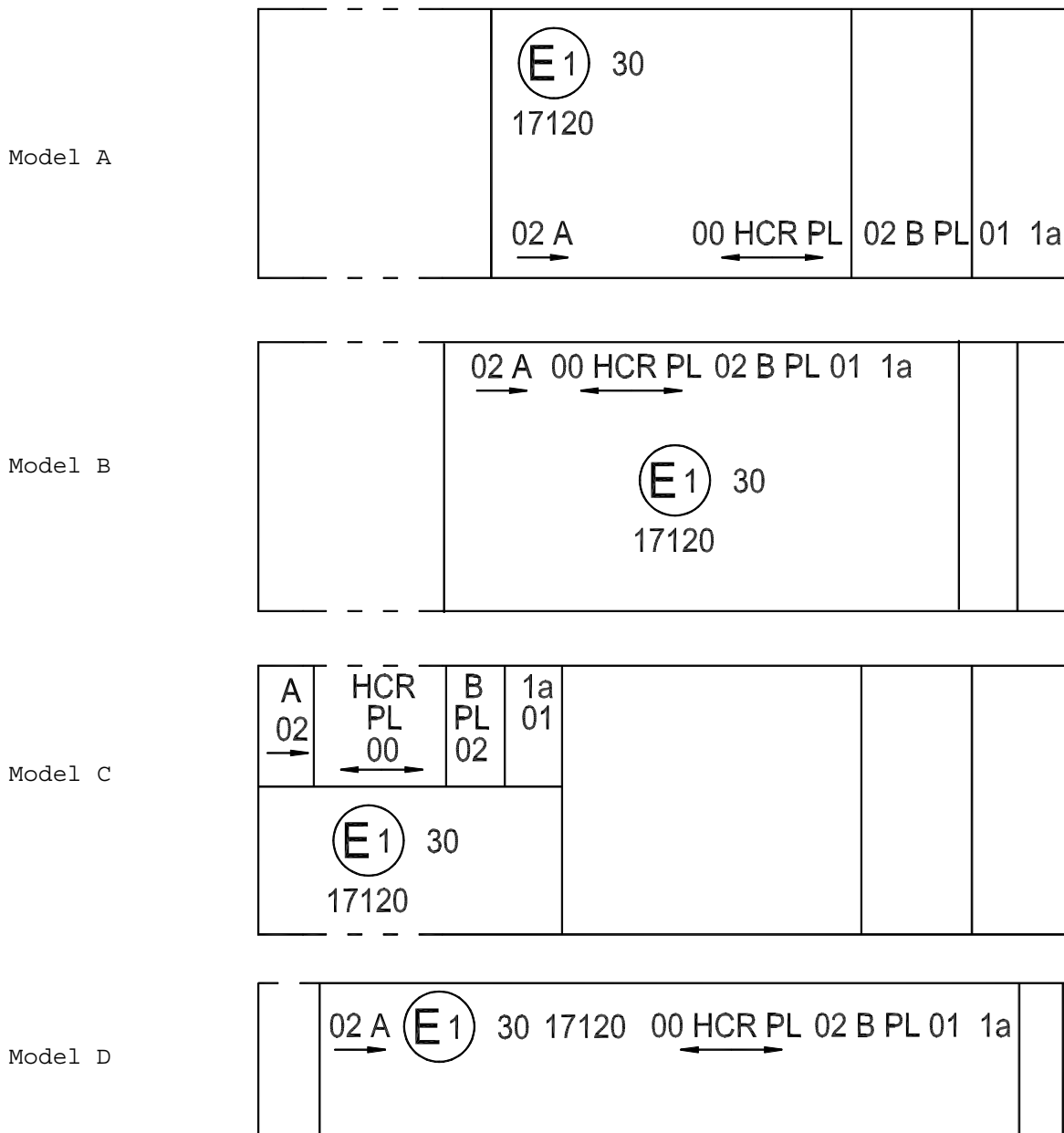

Note: The four examples above correspond to a lighting device bearing an approval mark comprising:

A front position lamp approved in accordance with the 02 series of amendments to Regulation No. 7,

A headlamp, Class B, with a passing beam designed for right- and left-hand traffic and a driving beam with a maximum intensity comprised between 86 250 and 101 250 candelas (as indicated by the number 30), approved in accordance with the requirements of this Regulation in its original form (00) and incorporating a lens of plastic material,

A front fog lamp approved in accordance with the 02 series of amendments to Regulation No. 19 and incorporating a lens of plastic material,

A front direction indicator lamp of category 1a approved in accordance with the 01 series of amendments to Regulation No. 6.

Figure 12

Lamp reciprocally incorporated with a headlamp

Example 1

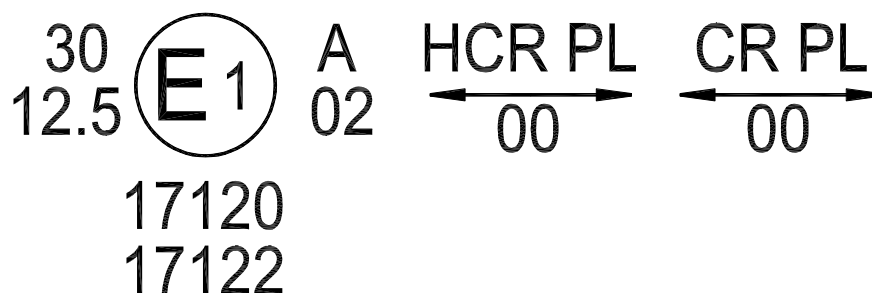

The above example corresponds to the marking of a lens of plastic material intended to be used in different types of headlamps, namely:

Either A headlamp, Class B, with a passing beam designed for both traffic systems and a driving beam with a maximum luminous intensity comprised between 86 250 and 101 250 candelas (as indicated by the number 30), approved in Germany (E1) in accordance with the requirements of this Regulation in its original form (00),

which is reciprocally incorporated with

A front position lamp approved in accordance with the 02 series of amendments to Regulation No. 7;

Or A headlamp, Class A, with a passing beam designed for both traffic systems and a driving beam with a maximum luminous intensity comprised between 33 750 cd and 45 000 cd (as indicated by the number 12.5), approved in Germany (E1) in accordance with the requirements of this Regulation in its original form (00),

B. Headlamp for left-hand traffic
 (dimension in mm with screen at 25 m distance)

STANDARD EUROPEAN BEAM

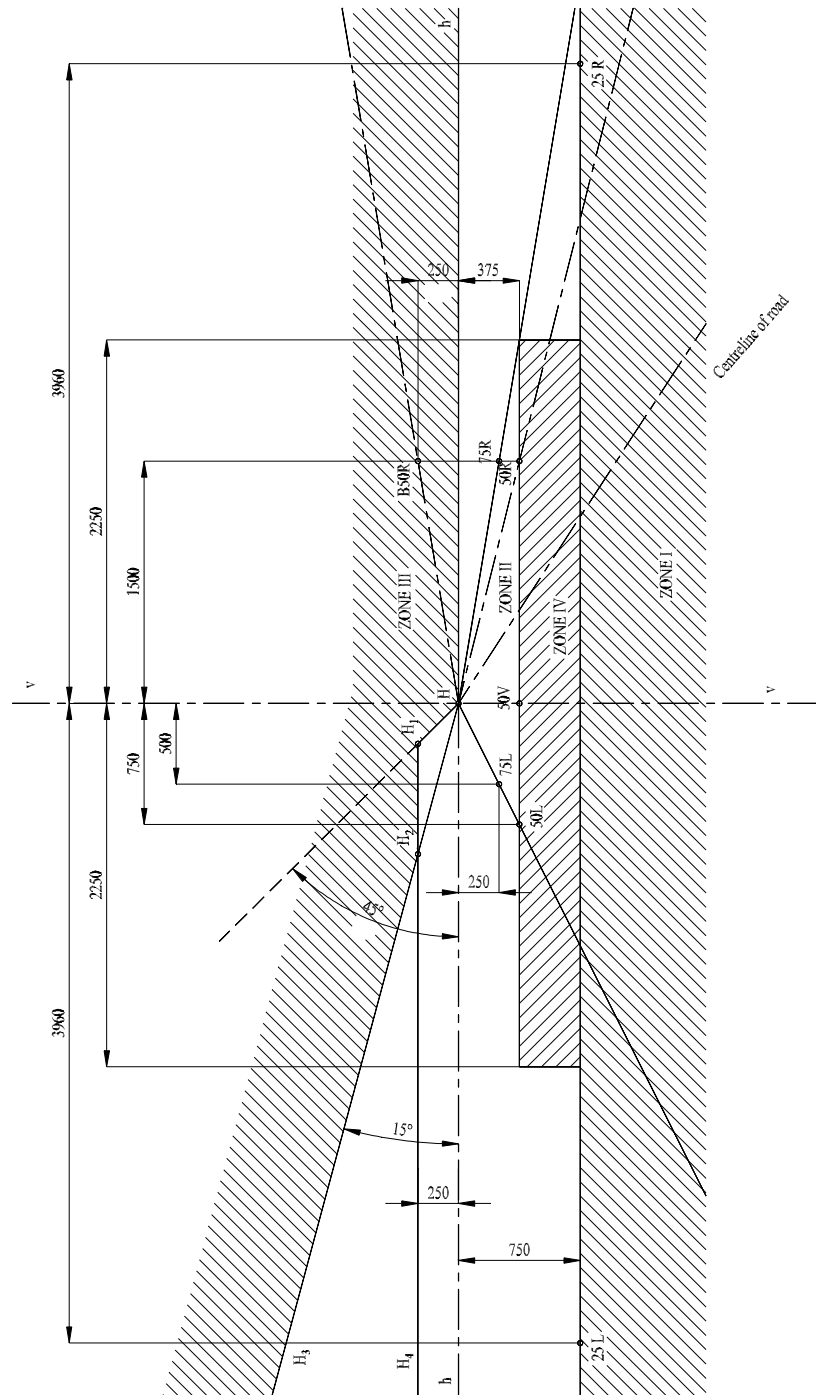

h-h : horizontal plane) passing through
 v-v : vertical plane) focus of headlamp

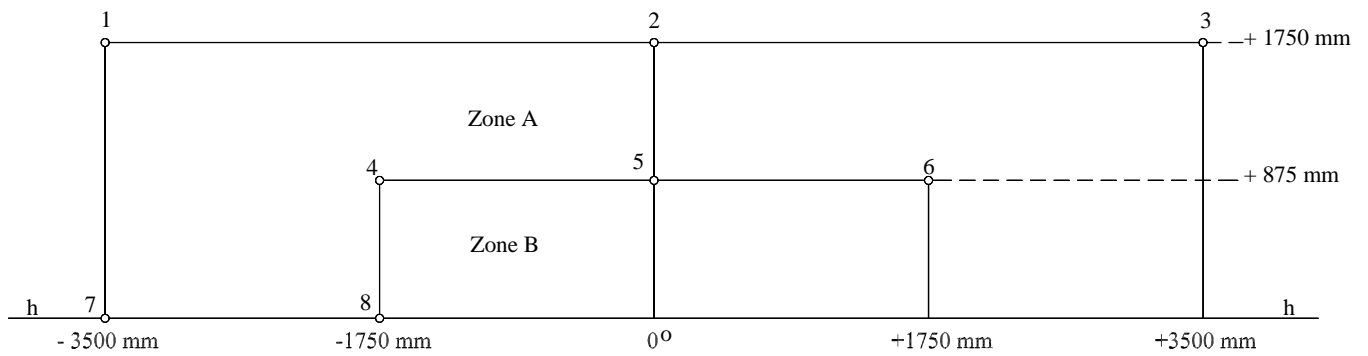
Figure C

Note: Figure C shows the measuring points for right-hand traffic. Points 7 and 8 move to their corresponding location at the right-hand side of the picture for left-hand traffic.

Annex 4

TESTS FOR STABILITY OF PHOTOMETRIC PERFORMANCE OF HEADLAMPS IN OPERATION

TESTS ON COMPLETE HEADLAMPS

Once the photometric values have been measured according to the prescriptions of this Regulation, in the point for E_{\max} for driving beam and in points HV, 50 R, B 50 L for passing beam (or HV, 50 L, B 50 R for headlamps designed for left-hand traffic) a complete headlamp sample shall be tested for stability of photometric performance in operation. "Complete headlamp" shall be understood to mean the complete lamp itself including those surrounding body parts and lamps which could influence its thermal dissipation.

1. TEST FOR STABILITY OF PHOTOMETRIC PERFORMANCE

The tests shall be carried out in a dry and still atmosphere at an ambient temperature of $23^{\circ}\text{C} \pm 5^{\circ}\text{C}$, the complete headlamp being mounted on a base representing the correct installation on the vehicle.

1.1. Clean headlamp

The headlamp shall be operated for 12 hours as described in paragraph 1.1.1. and checked as prescribed in paragraph 1.1.2.

1.1.1. Test procedure

The headlamp shall be operated for a period according to the specified time, so that:

- 1.1.1.1. (a) In the case where only one lighting function (driving or passing beam) is to be approved, the corresponding filament is lit for the prescribed time, 2/
- (b) In the case of a reciprocally incorporated passing lamp and driving lamp (dual filament lamp or two filament lamps):

If the applicant declares that the headlamp is to be used with a single filament lit 1/ at a time, the test shall be carried out in accordance with this condition, activating 2/ each specified function successively for half the time specified in paragraph 1.1.;

1/ Should two or more lamp filaments be simultaneously lit when headlamp flashing is used, this shall not be considered as being normal use of the filaments simultaneously.

2/ When the tested headlamp is grouped and/or reciprocally incorporated with signalling lamps, the latter shall be lit for the duration of the test. In the case of a direction indicator lamp, it shall be lit in flashing operation mode with an on/off time ratio of approximately one to one.

In all other cases, 1/ 2/ the headlamp shall be subjected to the following cycle until the time specified is reached:

15 minutes, passing-beam filament lit
5 minutes, all filaments lit;

- (c) In the case of grouped lighting functions all the individual functions shall be lit simultaneously for the time specified for individual lighting functions (a), also taking into account the use of reciprocally incorporated lighting functions (b), according to the manufacturer's specifications.

1.1.1.2. Test voltage

The voltage shall be adjusted so as to supply 90 per cent of the maximum wattage specified in Regulation No. 37 for the filament lamp(s) used.

The applied wattage shall in all cases comply with the corresponding value of a filament lamp of 12 V rated voltage, except if the applicant for approval specifies that the headlamp may be used at a different voltage. In the latter case, the test shall be carried out with the filament lamp whose wattage is the highest that can be used.

1.1.2. Test results

1.1.2.1. Visual inspection

Once the headlamp has been stabilized to the ambient temperature, the headlamp lens and the external lens, if any, shall be cleaned with a clean, damp cotton cloth. It shall then be inspected visually; no distortion, deformation, cracking or change in colour of either the headlamp lens or the external lens, if any, shall be noticeable.

1.1.2.2. Photometric test

To comply with the requirements of this Regulation, the photometric values shall be verified in the following points:

Passing beam:

50 R - B 50 L - HV for headlamps designed for right-hand traffic,
50 L - B 50 R - HV for headlamps designed for left-hand traffic.

Driving beam: Point of E_{\max}

Another aiming may be carried out to allow for any deformation of the headlamp base due to heat (the change of the position of the cut-off line is covered in paragraph 2 of this annex).

A 10 per cent discrepancy between the photometric characteristics and the values measured prior to the test is permissible including the tolerances of the photometric procedure.

1.2. Dirty headlamp

After being tested as specified in paragraph 1.1. above, the headlamp shall be operated for one hour as described in paragraph 1.1.1., after being prepared as prescribed in paragraph 1.2.1., and checked as prescribed in paragraph 1.1.2.

1.2.1. Preparations of the headlamp

1.2.1.1. Test mixture

1.2.1.1.1. For headlamp with the outside lens in glass:

The mixture of water and a polluting agent to be applied to the headlamp shall be composed of:

9 parts by weight of silica sand with a particle size of 0-100 μm ,

1 part by weight of vegetal carbon dust (beechwood) with a particle size of 0-100 μm ,

0.2 parts by weight of NaCMC 3/, and

an appropriate quantity of distilled water, with a conductivity of ≤ 1 mS/m.

The mixture must not be more than 14 days old.

1.2.1.1.2. For headlamp with outside lens in plastic material:

The mixture of water and polluting agent to be applied to the headlamp shall be composed of:

9 parts by weight of silica sand with a particle size of 0-100 μm ,

1 part by weight of vegetal carbon dust (beechwood) with a particle size of 0-100 μm ,

0.2 part by weight of NaCMC 3/,

13 parts by weight of distilled water with a conductivity of ≤ 1 mS/m, and

2 \pm 1 parts by weight of surface-actant 4/.

The mixture must not be more than 14 days old.

3/ NaCMC represents the sodium salt of carboxymethylcellulose, customarily referred to as CMC. The NaCMC used in the dirt mixture shall have a degree of substitution (DS) of 0.6-0.7 and a viscosity of 200-300 cP for a 2 per cent solution at 20°C.

4/ The tolerance on quantity is due to the necessity of obtaining a dirt that correctly spreads out on all the plastic lens.

1.2.1.2. Application of the test mixture to the headlamp

The test mixture shall be uniformly applied to the entire light-emitting surface of the headlamp and then left to dry. This procedure shall be repeated until the illumination value has dropped to 15-20 per cent of the values measured for each following point under the conditions described in this annex:

Point of E_{\max} in passing beam/driving beam and in driving beam only,
50 R and 50 V 5/ for a passing lamp only, designed for right-hand traffic,

50 L and 50 V 5/ for a passing lamp only, designed for left-hand traffic.

1.2.1.3. Measuring equipment

The measuring equipment shall be equivalent to that used during headlamp approval tests. A standard (étalon) filament lamp shall be used for the photometric verification.

2. TEST FOR CHANGE IN VERTICAL POSITION OF THE CUT-OFF LINE UNDER THE INFLUENCE OF HEAT

This test consists of verifying that the vertical drift of the cut-off line under the influence of heat does not exceed a specified value for an operating passing lamp.

The headlamp tested in accordance with paragraph 1, shall be subjected to the test described in paragraph 2.1., without being removed from or readjusted in relation to its test fixture.

2.1. Test

The test shall be carried out in a dry and still atmosphere at an ambient temperature of $23^{\circ}\text{C} \pm 5^{\circ}\text{C}$.

Using a mass production filament lamp, which has been aged for at least one hour the headlamp shall be operated on passing beam without being dismantled from or readjusted in relation to its test fixture. (For the purpose of this test, the voltage shall be adjusted as specified in paragraph 1.1.1.2.). The position of the cut-off line in its horizontal part (between vv and the vertical line passing through point B 50 L for right-hand traffic or B 50 R for left-hand traffic) shall be verified 3 minutes (r_3) and 60 minutes (r_{60}) respectively after operation.

The measurement of the variation in the cut-off line position as described above shall be carried out by any method giving acceptable accuracy and reproducible results.

5/ Point 50 V is situated 375 mm below HV on the vertical line v-v on the screen at 25 m distance.

2.2. Test results

2.2.1. The result in milliradians (mrad) shall be considered as acceptable for a passing lamp, only when the absolute value $\Delta r_I = | r_3 - r_{60} |$ recorded on the headlamp is not more than 1.0 mrad ($\Delta r_I \leq 1.0$ mrad).

2.2.2. However, if this value is more than 1.0 mrad but not more than 1.5 mrad ($1.0 \text{ mrad} < \Delta r_I \leq 1.5 \text{ mrad}$) a second headlamp shall be tested as described in paragraph 2.1. after being subjected three consecutive times to the cycle as described below, in order to stabilize the position of mechanical parts of the headlamp on a base representative of the correct installation on the vehicle:

Operation of the passing beam for one hour, (the voltage shall be adjusted as specified in paragraph 1.1.1.2.),

Period of rest for one hour.

The headlamp type shall be considered as acceptable if the mean value of the absolute values Δr_I measured on the first sample and Δr_{II} measured on the second sample is not more than 1.0 mrad.

$$\left(\frac{\Delta r_I + \Delta r_{II}}{2} \leq 1 \text{ mrad} \right)$$

Annex 5

MINIMUM REQUIREMENTS FOR CONFORMITY OF PRODUCTION CONTROL PROCEDURES

1. GENERAL
- 1.1. The conformity requirements shall be considered satisfied from a mechanical and a geometrical standpoint, if the differences do not exceed inevitable manufacturing deviations within the requirements of this Regulation. This condition also applies to colour.
- 1.2. With respect to photometric performances, the conformity of mass-produced headlamps shall not be contested if, when testing photometric performances of any headlamp chosen at random and equipped with a standard (étalon) filament lamp:
 - 1.2.1. no measured value deviates unfavourably by more than 20 per cent from the value prescribed in this Regulation. For values B 50 L (or R) and zone III, the maximum unfavourable deviation may be respectively:

| | | |
|----------------|--------------------|-------------|
| B 50 L (or R): | 0.2 lx equivalent | 20 per cent |
| | 0.3 lx equivalent | 30 per cent |
| Zone III | 0.3 lx equivalent | 20 per cent |
| | 0.45 lx equivalent | 30 per cent |
 - 1.2.2. or if
 - 1.2.2.1. for the passing beam, the values prescribed in this Regulation are met at HV (with a tolerance of + 0.2 lx) and related to that aiming at least one point of each area delimited on the measuring screen (at 25 m) by a circle 15 cm in radius around points B 50 L (or R) 1/ (with a tolerance of + 0.1 lx), 75 R (or L), 50 V, 25 R, 25 L, and in the entire area of zone IV which is not more than 22.5 cm above line 25 R and 25 L;
 - 1.2.2.2. and if, for the driving beam, HV being situated within the isolux $0.75 E_{\max}$, a tolerance of + 20 per cent for maximum values and -20 per cent for minimum values is observed for the photometric values at any measuring point specified in paragraph 6.3.2. of this Regulation.
 - 1.2.3. If the results of the test described above do not meet the requirements, the alignment of the headlamp may be changed, provided that the axis of the beam is not displaced laterally by more than 1° to the right or left. 2/
 - 1.2.4. If the results of the tests described above do not meet the requirements, tests shall be repeated using another standard (étalon) filament lamp.
- 1.3. With respect to the verification of the change in vertical position of the cut-off line under the influence of heat, the following procedure shall be applied:

1/ Letters in brackets refer to headlamps intended for left-hand traffic.

2/ See footnote 11/ in the text of this Regulation.

One of the sampled headlamps shall be tested according to the procedure described in paragraph 2.1. of annex 4 after being subjected three consecutive times to the cycle described in paragraph 2.2.2. of annex 4.

The headlamp shall be considered as acceptable if Δr does not exceed 1.5 mrad.

If this value exceeds 1.5 mrad but is not more than 2.0 mrad, a second sample shall be subjected to the test after which the mean of the absolute values recorded on both samples shall not exceed 1.5 mrad.

2. MINIMUM REQUIREMENTS FOR VERIFICATION OF CONFORMITY BY THE MANUFACTURER

For each type of headlamp the holder of the approval mark shall carry out at least the following tests, at appropriate intervals. The tests shall be carried out in accordance with the provision of this Regulation.

If any sampling shows non-conformity with regard to the type of test concerned, further samples shall be taken and tested. The manufacturer shall take steps to ensure the conformity of the production concerned.

2.1. Nature of tests

Tests of conformity in this Regulation shall cover the photometric characteristics and the verification of the change in vertical position of the cut-off line under the influence of heat.

2.2. Methods used in tests

2.2.1. Tests shall generally be carried out in accordance with the methods set out in this Regulation.

2.2.2. In any test of conformity carried out by the manufacturer, equivalent methods may be used with the consent of the competent authority responsible for approval tests. The manufacturer is responsible for proving that the applied methods are equivalent to those laid down in this Regulation.

2.2.3. The application of paragraphs 2.2.1. and 2.2.2. requires regular calibration of test apparatus and its correlation with measurement made by a competent authority.

2.2.4. In all cases the reference methods shall be those of this Regulation, particular for the purpose of administrative verification and sampling.

2.3. Nature of sampling

Samples of headlamps shall be selected at random from the production of a uniform batch. A uniform batch means a set of headlamps of the same type, defined according to the production methods of the manufacturer.

The assessment shall, in general, cover series production from individual factories. However, a manufacturer may group together records concerning the same type from several factories provided these operate under the same quality system and quality management.

2.4. Measured and recorded photometric characteristics

The sampled headlamps shall be subjected to photometric measurements at the points provided for in the Regulation, the reading being limited at the points E_{\max} , HV 3/, HL, HR 4/ in the case of a driving beam, and to points B 50 L (or R), HV, 50 V, 75 R (or L) and 25 L (or R) in the case of the passing beam (see figure in annex 3).

2.5. Criteria governing acceptability

The manufacturer is responsible for carrying out a statistical study of the test results and for defining, in agreement with the competent authority, criteria governing acceptability of his products in order to meet the specification laid down for verification of conformity of products in paragraph 10.1. of this Regulation.

The criteria governing acceptability shall be such that, with a confidence level of 95 per cent, the minimum probability of passing a spot check in accordance with annex 7 (first sampling) would be 0.95.

3/ When the driving beam is reciprocally incorporated with the passing beam, HV in the case of the driving beam shall be the same measuring point as in the case of the passing beam.

4/ HL and HR: points "hh" located at 1.125 m to the left and to the right of point HV respectively.

Annex 6

**REQUIREMENTS FOR LAMPS INCORPORATING LENSES OF PLASTIC MATERIAL
- TESTING OF LENS OR MATERIAL SAMPLES AND OF COMPLETE LAMPS**

1. GENERAL SPECIFICATIONS

1.1. The samples supplied pursuant to paragraph 2.2.4. of this Regulation shall satisfy the specifications indicated in paragraphs 2.1. to 2.5. below.

1.2. The two samples of complete lamps supplied pursuant to paragraph 2.2.3. of this Regulation and incorporating lenses of plastic material shall, with regard to the lens material, satisfy the specifications indicated in paragraph 2.6. below.

1.3. The samples of lenses of plastic material or samples of material shall be subjected, with the reflector to which they are intended to be fitted (where applicable), to approval tests in the chronological order indicated in table A reproduced in appendix 1 to this annex.

1.4. However, if the lamp manufacturer can prove that the product has already passed the tests prescribed in paragraphs 2.1. to 2.5. below, or the equivalent tests pursuant to another regulation, those tests need not be repeated; only the tests prescribed in appendix 1, table B, shall be mandatory.

2. TESTS

2.1. Resistance to temperature changes

2.1.1. Tests

Three new samples (lenses) shall be subjected to five cycles of temperature and humidity (RH = relative humidity) change in accordance with the following programme:

3 hours at $40^{\circ}\text{C} \pm 2^{\circ}\text{C}$ and 85-95 per cent RH;

1 hour at $23^{\circ}\text{C} \pm 5^{\circ}\text{C}$ and 60-75 per cent RH;

15 hours at $-30^{\circ}\text{C} \pm 2^{\circ}\text{C}$;

1 hour at $23^{\circ}\text{C} \pm 5^{\circ}\text{C}$ and 60-75 per cent RH;

3 hours at $80^{\circ}\text{C} \pm 2^{\circ}\text{C}$;

1 hour at $23^{\circ}\text{C} \pm 5^{\circ}\text{C}$ and 60-75 per cent RH;

Before this test, the samples shall be kept at $23^{\circ}\text{C} \pm 5^{\circ}\text{C}$ and 60-75 per cent RH for at least four hours.

Note: The periods of one hour at $23^{\circ}\text{C} \pm 5^{\circ}\text{C}$ shall include the periods of transition from one temperature to another which are needed in order to avoid thermal shock effects.

2.1.2. Photometric measurements

2.1.2.1. Method

Photometric measurements shall be carried out on the samples before and after the test.

These measurements shall be made using a standard (étalon) lamp, at the following points:

B 50 L and 50 R for the passing beam of a passing lamp or a passing/driving lamp (B 50 R and 50 L in the case of headlamps intended for left-hand traffic);

E_{\max} route for the driving beam of a driving lamp or a passing/driving lamp.

2.1.2.2. Results

The variation between the photometric values measured on each sample before and after the test shall not exceed 10 per cent including the tolerances of the photometric procedure.

2.2. Resistance to atmospheric and chemical agents

2.2.1. Resistance to atmospheric agents

Three new samples (lenses or samples of material) shall be exposed to radiation from a source having a spectral energy distribution similar to that of a black body at a temperature between 5,500 K and 6,000 K. Appropriate filters shall be placed between the source and the samples so as to reduce as far as possible radiations with wave lengths smaller than 295 nm and greater than 2,500 nm. The samples shall be exposed to an energetic illumination of $1,200 \text{ W/m}^2 \pm 200 \text{ W/m}^2$ for a period such that the luminous energy that they receive is equal to $4,500 \text{ MJ/m}^2 \pm 200 \text{ MJ/m}^2$. Within the enclosure, the temperature measured on the black panel placed on a level with the samples shall be $50^\circ\text{C} \pm 5^\circ\text{C}$. In order to ensure a regular exposure, the samples shall revolve around the source of radiation at a speed between 1 and 5 1/min.

The samples shall be sprayed with distilled water of conductivity lower than 1 mS/m at a temperature of $23^\circ\text{C} \pm 5^\circ\text{C}$, in accordance with the following cycle:

spraying: 5 minutes; drying: 25 minutes.

2.2.2. Resistance to chemical agents

After the test described in paragraph 2.2.1. above and the measurement described in paragraph 2.2.3.1. below have been carried out, the outer face of the said three samples shall be treated as described in paragraph 2.2.2.2. with the mixture defined in paragraph 2.2.2.1. below.

2.2.2.1. Test mixture

The test mixture shall be composed of 61.5 per cent n-heptane, 12.5 per cent toluene, 7.5 per cent ethyl tetrachloride, 12.5 per cent trichloroethylene and 6 per cent xylene (volume per cent).

2.2.2.2. Application of the test mixture

Soak a piece of cotton cloth (as per ISO 105) until saturation with the mixture defined in paragraph 2.2.2.1. above and, within 10 seconds, apply it for 10 minutes to the outer face of the sample at a pressure of 50 N/cm², corresponding to an effort of 100 N applied on a test surface of 14 x 14 mm.

During this 10-minute period, the cloth pad shall be soaked again with the mixture so that the composition of the liquid applied is continuously identical with that of the test mixture prescribed.

During the period of application, it is permissible to compensate the pressure applied to the sample in order to prevent it from causing cracks.

2.2.2.3. Cleaning

At the end of the application of the test mixture, the samples shall be dried in the open air and then washed with the solution described in paragraph 2.3. (Resistance to detergents) 23°C ± 5°C.

Afterwards the samples shall be carefully rinsed with distilled water containing not more than 0.2 per cent impurities at 23°C ± 5°C and then wiped off with a soft cloth.

2.2.3. Results

2.2.3.1. After the test of resistance to atmospheric agents, the outer face of the samples shall be free from cracks, scratches, chipping and deformation, and the mean variation in transmission $\Delta t = \frac{T_2 - T_3}{T_2}$, measured on the three samples according to the procedure described in appendix 2 to this annex shall not exceed 0.020 ($\Delta t_m \leq 0.020$).

2.2.3.2. After the test of resistance to chemical agents, the samples shall not bear any traces of chemical staining likely to cause a variation of flux diffusion, whose mean variation $\Delta d = \frac{T_5 - T_4}{T_2}$, measured on the three samples according to the procedure described in appendix 2 to this annex shall not exceed 0.020 ($\Delta d_m \leq 0.020$).

2.3. Resistance to detergents and hydrocarbons

2.3.1. Resistance to detergents

The outer face of three samples (lenses or samples of material) shall be heated to $50^{\circ}\text{C} \pm 5^{\circ}\text{C}$ and then immersed for five minutes in a mixture maintained at $23^{\circ}\text{C} \pm 5^{\circ}\text{C}$ and composed of 99 parts distilled water containing not more than 0.02 per cent impurities and one part alkylaryl sulphonate.

At the end of the test, the samples shall be dried at $50^{\circ}\text{C} \pm 5^{\circ}\text{C}$.

The surface of the samples shall be cleaned with a moist cloth.

2.3.2. Resistance to hydrocarbons

The outer face of these three samples shall then be lightly rubbed for one minute with a cotton cloth soaked in a mixture composed of 70 per cent n-heptane and 30 per cent toluene (volume per cent), and shall then be dried in the open air.

2.3.3. Results

After the above two tests have been performed successively, the mean value of the variation in transmission $\Delta t = \frac{T_2 - T_3}{T_2}$, measured on the three samples according to the procedure described in appendix 2 to this annex shall not exceed 0.010 ($\Delta t_m \leq 0.010$).

2.4. Resistance to mechanical deterioration

2.4.1. Mechanical deterioration method

The outer face of the three new samples (lenses) shall be subjected to the uniform mechanical deterioration test by the method described in appendix 3 to this annex.

2.4.2. Results

After this test, the variations:

in transmission: $\Delta t = \frac{T_2 - T_3}{T_2}$,

and in diffusion: $\Delta d = \frac{T_5 - T_4}{T_2}$,

shall be measured according to the procedure described in appendix 2 in the area specified in paragraph 2.2.4.1.1. of this Regulation. The mean value of the three samples shall be such that:

$$\Delta t_m \leq 0.100;$$

$$\Delta d_m \leq 0.050.$$

2.5. Test of adherence of coatings, if any

2.5.1. Preparation of the sample

A surface of 20 mm x 20 mm in area of the coating of a lens shall be cut with a razor blade or a needle into a grid of squares approximately 2 mm x 2 mm. The pressure on the blade or needle shall be sufficient to cut at least the coating.

2.5.2. Description of the test

Use an adhesive tape with a force adhesion of 2 N/(cm of width) \pm 20 per cent measured under the standardized conditions specified in appendix 4 to this annex. This adhesive tape, which shall be at least 25 mm wide, shall be pressed for at least five minutes to the surface prepared as prescribed in paragraph 2.5.1.

Then the end of the adhesive tape shall be loaded in such a way that the force of adhesion to the surface considered is balanced by a force perpendicular to that surface. At this stage, the tape shall be torn off at a constant speed of 1.5 m/s \pm 0.2 m/s.

2.5.3. Results

There shall be no appreciable impairment of the gridded area. Impairments at the intersections between squares or at the edges of the cuts shall be permitted, provided that the impaired area does not exceed 15 per cent of the gridded surface.

2.6. Tests of the complete headlamp incorporating a lens of plastic material

2.6.1. Resistance to mechanical deterioration of the lens surface

2.6.1.1. Tests

The lens of lamp sample No. 1 shall be subjected to the test described in paragraph 2.4.1. above.

2.6.1.2. Results

After the test, the results of photometric measurements carried out on the headlamp in accordance with this Regulation shall not exceed by more than 30 per cent the maximum values prescribed at points B 50 L and HV and not be more than 10 per cent below the minimum values prescribed at point 75 R (in the case of headlamps intended for left-hand traffic, the points to be considered are B 50 R, HV and 75 L).

2.6.2. Test of adherence of coatings, if any

The lens of lamp sample No. 2 shall be subjected to the test described in paragraph 2.5. above.

3. VERIFICATION OF THE CONFORMITY OF PRODUCTION

3.1. With regard to the materials used for the manufacture of lenses, the lamps of a series shall be recognized as complying with this Regulation if:

- 3.1.1. After the test for resistance to chemical agents and the test for resistance to detergents and hydrocarbons, the outer face of the samples exhibits no cracks, chipping or deformation visible to the naked eye (see paras. 2.2.2., 2.3.1. and 2.3.2.);
- 3.1.2. After the test described in paragraph 2.6.1.1., the photometric values at the points of measurement considered in paragraph 2.6.1.2. are within the limits prescribed for conformity of production by this Regulation.
- 3.2. If the test results fail to satisfy the requirements, the tests shall be repeated on another sample of headlamps selected at random.

B. Tests on complete headlamps (supplied pursuant to paragraph 2.2.3. of this Regulation).

| Tests | Complete headlamp | |
|-------------------------------------|-------------------|---|
| | Sample No. | |
| | 1 | 2 |
| 2.1. Deterioration (para. 2.6.1.1.) | x | |
| 2.2. Photometry (para. 2.6.1.2.) | x | |
| 2.3. Adherence (para. 2.6.2.) | | x |

Annex 6 - Appendix 2

METHOD OF MEASUREMENT OF THE DIFFUSION AND TRANSMISSION OF LIGHT

1. EQUIPMENT (see figure)

The beam of a collimator K with a half divergence $\beta/2 = 17.4 \times 10^4$ rd is limited by a diaphragm D_i with an opening of 6 mm against which the sample stand is placed.

A convergent achromatic lens L_2 , corrected for spherical aberrations links the diaphragm D_i with the receiver R; the diameter of the lens L_2 shall be such that it does not diaphragm the light diffused by the sample in a cone with a half top angle of $\beta/2 = 14^\circ$.

An annular diaphragm D_D , with angles $\alpha_o/2 = 1^\circ$ and $\alpha_{max}/2 = 12^\circ$ is placed in an image focal plane of the lens L_2 .

The non-transparent central part of the diaphragm is necessary in order to eliminate the light arriving directly from the light source. It shall be possible to remove the central part of the diaphragm from the light beam in such a manner that it returns exactly to its original position.

The distance $L_2 D_i$ and the focal length F_2 1/ of the lens L_2 shall be so chosen that the image of D_i completely covers the receiver R.

When the initial incident flux is referred to 1,000 units, the absolute precision of each reading shall be better than 1 unit.

2. MEASUREMENTS

The following readings shall be taken:

| Reading | With sample | With central part of D_D | Quantity represented |
|---------|----------------------|----------------------------|--|
| T_1 | no | no | Incident flux in initial reading |
| T_2 | yes (before test) | no | Flux transmitted by the new material in a field of 24° |
| T_3 | yes (after test) | no | Flux transmitted by the tested material in a field of 24° |
| T_4 | yes (before test) | yes | Flux diffused by the new material |
| T_5 | yes (after test) | yes | Flux diffused by the tested material |

1/ For L_2 it is recommended to use a focal distance of about 80 mm.

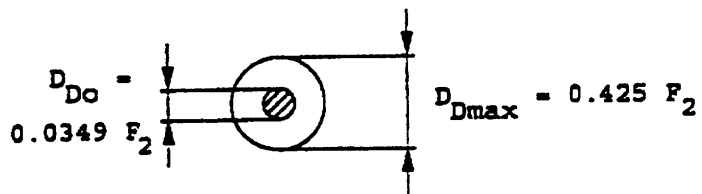
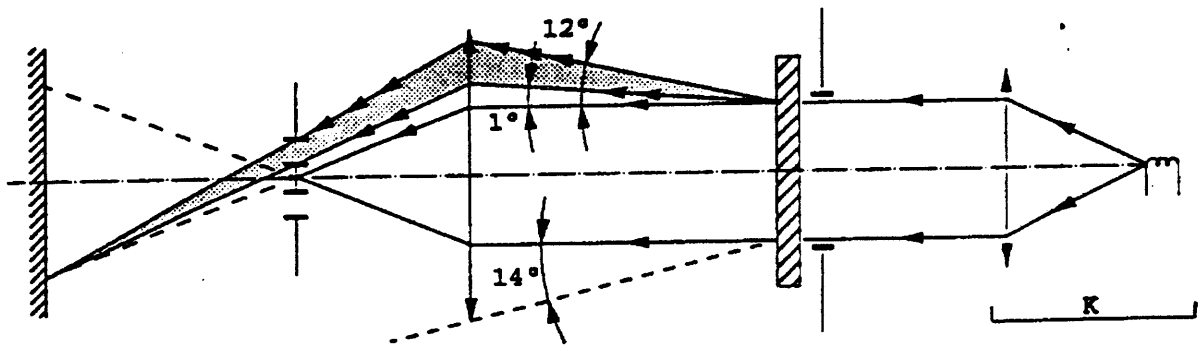

Annex 6 - Appendix 3

SPRAY TESTING METHOD

1. Test equipment

1.1. Spray gun

The spray gun used shall be equipped with a nozzle 1.3 mm in diameter allowing a liquid flow rate of 0.24 ± 0.02 l/minute at an operating pressure of 6.0 bars - 0, + 0.5 bar.

Under these operation conditions the fan pattern obtained shall be $170 \text{ mm} \pm 50 \text{ mm}$ in diameter on the surface exposed to deterioration, at a distance of $380 \text{ mm} \pm 10 \text{ mm}$ from the nozzle.

1.2. Test mixture

The test mixture shall be composed of:

Silica sand of hardness 7 on the Mohr scale, with a grain size between 0 and 0.2 mm and an almost normal distribution, with an angular factor of 1.8 to 2;

Water of hardness not exceeding 205 g/m^3 for a mixture comprising 25 g of sand per litre of water.

2. Test

The outer surface of the lamp lenses shall be subjected once or more than once to the action of the sand jet produced as described above. The jet shall be sprayed almost perpendicular to the surface to be tested.

The deterioration shall be checked by means of one or more samples of glass placed as a reference near the lenses to be tested. The mixture shall be sprayed until the variation in the diffusion of light on the sample or samples measured by the method described in appendix 2, is such that:

$$\Delta d = \frac{T_5 - T_4}{T_2} = 0.0250 \pm 0.0025$$

Several reference samples may be used to check that the whole surface to be tested has deteriorated homogeneously.

Annex 6 - Appendix 4

ADHESIVE TAPE ADHERENCE TEST

1. PURPOSE

This method allows to determine under standard conditions the linear force of adhesion of an adhesive tape to a glass plate.

2. PRINCIPLE

Measurement of the force necessary to unstick an adhesive tape from a glass plate at an angle of 90°.

3. SPECIFIED ATMOSPHERIC CONDITIONS

The ambient conditions shall be at 23° C ± 5° C and 65 ± 15 per cent RH.

4. TEST PIECES

Before the test, the sample roll of adhesive tape shall be conditioned for 24 hours in the specified atmosphere (see para. 3 above).

Five test pieces each 400 mm long shall be tested from each roll. These test pieces shall be taken from the roll after the first three turns were discarded.

5. PROCEDURE

The test shall be under the ambient conditions specified in paragraph 3.

Take the five test pieces while unrolling the tape radially at a speed of approximately 300 mm/s, then apply them within 15 seconds in the following manner:

Apply the tape to the glass plate progressively with a slight length-wise rubbing movement of the finger, without excessive pressure, in such a manner as to leave no air bubble between the tape and the glass plate.

Leave the assembly in the specified atmospheric conditions for 10 minutes.

Unstick about 25 mm of the test piece from the plate in a plane perpendicular to the axis of the test piece.

Fix the plate and fold back the free end of the tape at 90°. Apply force in such a manner that the separation line between the tape and the plate is perpendicular to this force and perpendicular to the plate.

Pull to unstick at a speed of 300 mm/s ± 30 mm/s and record the force required.

6. RESULTS

The five values obtained shall be arranged in order and the median value taken as a result of the measurement. This value shall be expressed in Newtons per centimetre of width of the tape.

Annex 7

MINIMUM REQUIREMENTS FOR SAMPLING BY AN INSPECTOR

1. GENERAL
- 1.1. The conformity requirements shall be considered satisfied from a mechanical and a geometrical standpoint in accordance with the requirements of this Regulation, if any, if the differences do not exceed inevitable manufacturing deviations. This condition also applies to colour.
- 1.2. With respect to photometric performances, the conformity of mass-produced headlamps shall not be contested if, when testing photometric performances of any headlamp chosen at random and equipped with a standard filament lamp:
 - 1.2.1. no measured value deviates unfavourably by more than 20 per cent from the value prescribed in this Regulation. For values B 50 L (or R) and zone III, the maximum unfavourable deviation may be respectively:

| | | |
|----------------|--------------------|-------------|
| B 50 L (or R): | 0.2 lx equivalent | 20 per cent |
| | 0.3 lx equivalent | 30 per cent |
| Zone III | 0.3 lx equivalent | 20 per cent |
| | 0.45 lx equivalent | 30 per cent |
 - 1.2.2. or if
 - 1.2.2.1. for the passing beam, the values prescribed in this Regulation are met at HV (with a tolerance of 0.2 lx) and related to that aiming at least one point of each area delimited on the measuring screen (at 25 m) by a circle 15 cm in radius around points B 50 L (or R) (with a tolerance of 0.1 lx), 75 R (or L), 50 V, 25 R, 25 L, and in the entire area of zone IV which is not more than 22.5 cm above line 25 R and 25 L;
 - 1.2.2.2. and if, for the driving beam, HV being situated within the isolux $0.75 E_{\max}$, a tolerance of + 20 per cent for maximum values and - 20 per cent for minimum values is observed for the photometric values at any measuring point specified in paragraph 6.3.2. of this Regulation. The reference mark is disregarded.
 - 1.2.3. If the results of the test described above do not meet the requirements, the alignment of the headlamp may be changed, provided that the axis of the beam is not displaced laterally by more than 1° to the right or left. 1/
 - 1.2.4. If the results of the tests described above do not meet the requirements, tests shall be repeated using another standard filament lamp.
 - 1.2.5. Headlamps with apparent defects are disregarded.
 - 1.2.6. The reference mark is disregarded.

1/ See footnote 11/ in the text of this Regulation.

2. FIRST SAMPLING

In the first sampling four headlamps are selected at random. The first sample of two is marked A, the second sample of two is marked B.

2.1. The conformity is not contested

2.1.1. Following the sampling procedure shown in Figure 1 of this annex the conformity of mass-produced headlamps shall not be contested if the deviations of the measured values of the headlamps in the unfavourable directions are:

2.1.1.1. sample A

A1: one headlamp 0 per cent
one headlamp not more than 20 per cent

A2: both headlamps more than 0 per cent
but not more than 20 per cent
go to sample B

2.1.1.2. sample B

B1: both headlamps 0 per cent

2.1.2. or if the conditions of paragraph 1.2.2. for sample A are fulfilled.

2.2. The conformity is contested

2.2.1. Following the sampling procedure shown in Figure 1 of this annex the conformity of mass-produced headlamps shall be contested and the manufacturer requested to make his production meet the requirements (alignment) if the deviations of the measured values of the headlamps are:

2.2.1.1. sample A

A3: one headlamp not more than 20 per cent
one headlamp more than 20 per cent
but not more than 30 per cent

2.2.1.2. sample B

B2: in the case of A2
one headlamp more than 0 per cent
but not more than 20 per cent
one headlamp not more than 20 per cent

B3: in the case of A2
one headlamp 0 per cent
one headlamp more than 20 per cent
but not more than 30 per cent

2.2.2. or if the conditions of paragraph 1.2.2. for sample A are not fulfilled.

2.3. Approval withdrawn

Conformity shall be contested and paragraph 11 applied if, following the sampling procedure shown in Figure 1 of this annex, the deviations of the measured values of the headlamps are:

2.3.1. sample A

A4: one headlamp not more than 20 per cent
 one headlamp more than 30 per cent

A5: Both headlamps more than 20 per cent

2.3.2. sample B

B4: in the case of A2
 one headlamp more than 0 per cent
 but not more than 20 per cent
 one headlamp more than 20 per cent

B5: in the case of A2
 both headlamps more than 20 per cent

B6: in the case of A2
 one headlamp 0 per cent
 one headlamp more than 30 per cent

2.3.3. or if the conditions of paragraph 1.2.2. for samples A and B are not fulfilled.

3. REPEATED SAMPLING

In the case of A3, B2, B3 a repeated sampling, third sample C of two headlamps, selected from stock manufactured after alignment, is necessary within two months' time after the notification.

3.1. The conformity is not contested

3.1.1. Following the sampling procedure shown in Figure 1 of this annex the conformity of mass-produced headlamps shall not be contested if the deviations of the measured values of the headlamps are:

3.1.1.1. sample C

C1: one headlamp 0 per cent
 one headlamp not more than 20 per cent

C2: both headlamps more than 0 per cent
 but not more than 20 per cent
 go to sample D

3.1.1.2. sample D

D1: in the case of C2
 both headlamps 0 per cent

3.1.2. or if the conditions of paragraph 1.2.2. for sample C are fulfilled.

3.2. The conformity is contested

3.2.1. Following the sampling procedure shown in Figure 1 of this annex the conformity of mass-produced headlamps shall be contested and the manufacturer requested to make his production meet the requirements (alignment) if the deviations of the measured values of the headlamps are:

3.2.1.1. sample D

D2: in the case of C2
one headlamp more than 0 per cent
but not more than 20 per cent
one headlamp not more than 20 per cent

3.2.1.2. or if the conditions of paragraph 1.2.2 for sample C are not fulfilled.

3.3. Approval withdrawn

Conformity shall be contested and paragraph 11 applied if, following the sampling procedure shown in Figure 1 of this annex, the deviations of the measured values of the headlamps are:

3.3.1. sample C

C3: one headlamp not more than 20 per cent
one headlamp more than 20 per cent
C4: both headlamps more than 20 per cent

3.3.2. sample D

D3: in the case of C2
one headlamp 0 or more than 0 per cent
one headlamp more than 20 per cent

3.3.3. or if the conditions of paragraph 1.2.2. for samples C and D are not fulfilled.

4. CHANGE OF THE VERTICAL POSITION OF THE CUT-OFF LINE

With respect to the verification of the change in vertical position of the cut-off line under the influence of heat, the following procedure shall be applied:

One of the headlamps of sample A after sampling procedure in Figure 1 of this annex shall be tested according to the procedure described in paragraph 2.1. of annex 4 after being subjected three consecutive times to the cycle described in paragraph 2.2.2. of annex 4.

The headlamp shall be considered as acceptable if Δr does not exceed 1.5 mrad.

If this value exceeds 1.5 mrad but is not more than 2.0 mrad, the second headlamp of sample A shall be subjected to the test after which the mean of the absolute values recorded on both samples shall not exceed 1.5 mrad.

However, if this value of 1.5 mrad on sample A is not complied with, the two headlamps of sample B shall be subjected to the same procedure and the value of Δr for each of them shall not exceed 1.5 mrad.

Figure 1

